



DABtool

Damper Antivibration Bar



Barre Antivibranti
Antivibration Bars
Barres Antivibrations
Schwingungsgedämpfte Bohrstangen
Barras Antivibraciones

DABtool, perché sono necessarie? / Why are they needed?

Generalmente nelle lavorazioni di BARENATURA PROFONDA il diametro della barra è limitato dal diametro del foro da lavorare. Più piccolo è il foro, più piccolo è il diametro della barra da utilizzare. Questo significa che una barra "piccola" potrebbe causare delle vibrazioni se il foro da lavorare fosse troppo profondo.

Normally in DEEP HOLE BORING operations the diameter of the boring bar is limited by the dimensions of the hole diameter to be bored.

The smaller the hole the smaller the diameter of the bar and has to be.

This also means that a "thin" bar will possibly cause vibrations if the hole to be machined is deep.

**LE GAMMA DELLE BARRE ANTIVIBRANTI
DABtool DISPONE DI PICCOLI DIAMETRI
CHE POSSONO EVITARE LA MAGGIOR
PARTE DELLE VIBRAZIONI.**

**DABtool ANTI-VIBRATIONS BARS
PROVIDE SMALL DIAMETERS
AND CAN PREVENT MOST VIBRATIONS**

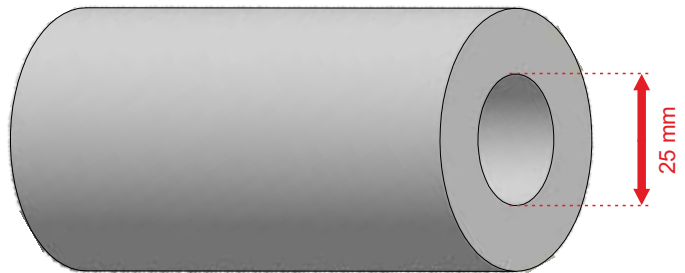

Gli utensili standard arrivano al massimo ad un rapporto di profondità di barenatura di 4 volte il diametro.

Gli utensili in Metallo Duro hanno un rapporto massimo di profondità di barenatura 6 volte il diametro. Solo utensili come le barre antivibranti **DABtool** svolgono perfettamente la lavorazione oltre i 6 x D.

Standard tools can only reach a maximum cutting ratio of 4 x Diameter.

Tools in HM can reach a cutting ratio of 6 x D.

*But, beyond this, only specialized tools, such as a **DABtool** anti-vibration bars, can get the job done.*

DABtool garantiscono / can manage:

- **LAVORAZIONI ACCURATE
ACCURATE MACHINING**
- **TOLLERANZE PRECISE
PRECISE TOLERANCES**
- **OTTIME FINITURE
GOOD FINISH**

Le lavorazioni di barenatura profonda hanno svariati problemi, ma i 3 più comuni sono:

Deep hole boring has different issues, but 3 are the most common:

- **LIMITATA DURATA DELL'INSERTO
POOR INSERT LIFE**
- **DIFFICOLTÀ NEL MANTENERE LE TOLLERANZE
POOR MACHINING TOLERANCE**
- **FINITURE NON SODDISFACENTI
POOR SURFACE FINISH**



Machining with **DABtool**

DABtool: tre, due, uno... / three, two, one...

L'esperienza, la ricerca e lo sviluppo interno in Comand Tool hanno consentito la "creazione" del sistema TRE, DUE, UNO: il sistema **DABtool**.

*Comand Tool experience and R&D have developed a simple THREE, TWO, ONE boring bar solution, the **DABtool** system.*

3 LINEE DI BARRE / LINES OF BARS

2 LINEE DI TESTINE / LINE OF HEADS

1 SISTEMA DI ACCOPPIAMENTO TESTINE / HEAD COUPLING SYSTEM

Le **3 LINEE DI BARRE** sono così composte / *The 3 LINE OF BARS are composed as follows:*

1- ACCIAIO / STEEL

- Diametri / *diameters* 20, 25, 32, 40, 50, 60 mm
- 5 volte il diametro / *5 times diameter*



■ acciaio / steel

2- ACCIAIO con DAMPER / STEEL with DAMPER

- Diametri / *diameters* 20, 25, 32, 40, 50, 60 mm
- 8 e 10 volte il diametro / *8 and 10 times diameter*



■ acciaio / steel ■ damper

3- ACCIAIO con METALLO DURO e DAMPER / STEEL with HM and DAMPER

- Diametri / *diameters* 20, 25, 32 mm
- 12 e 14 volte il diametro / *12 and 14 times diameter*
- Diametri / *diameters* 40, 50, 60 mm
- 12 volte il diametro / *12 times diameter*



■ acciaio / steel ■ damper ■ metallo duro / hard metal

Caratteristiche delle barre / Bars features

- Stelo in acciaio speciale
Solid steel body
- L'acciaio viene trattato appositamente per ottenere il massimo smorzamento delle vibrazioni
Steel is specially treated to obtain vibration damping specifications
- Foro per il passaggio del liquido refrigerante
Thru coolant passage
- Raccordo filettato resistente fino a 70 bar
Threaded coolant connection for high pressure 70 bar max
- Un unico attacco per diversi modelli di testina
Head coupling plate for different head models
- Attacco accoppiamento testina compatibile con più marche
Head coupling with multi brand compatible attachment
- Damper per assorbimento delle vibrazioni con foro per il passaggio del liquido refrigerante
Vibration damper system with through coolant passage
- Inserto in Metallo Duro, con foro per il passaggio del liquido refrigerante, per conferire maggiore rigidità e massimo assorbimento delle vibrazioni
Hard Metal insert with thru coolant for additional rigidity and vibration damping capability

1- **ACCIAIO / STEEL** - D 20, 25, 32, 40, 50, 60 mm - **5 x D**

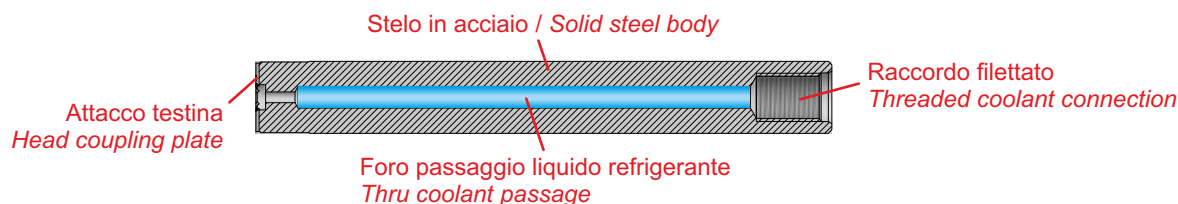

2- **ACCIAIO con DAMPER / STEEL with DAMPER** - D 20, 25, 32, 40, 50, 60 mm - **8/10 x D**

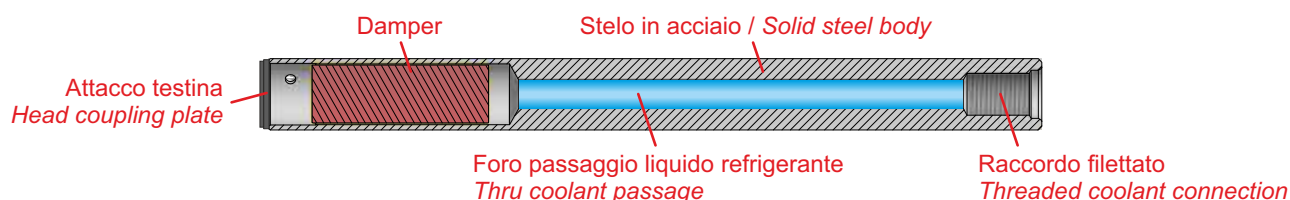

3- **ACCIAIO con MD e DAMPER / STEEL with HM and DAMPER** - D 20, 25, 32 - **12/14 x D** | D 40, 50, 60 - **12xD**

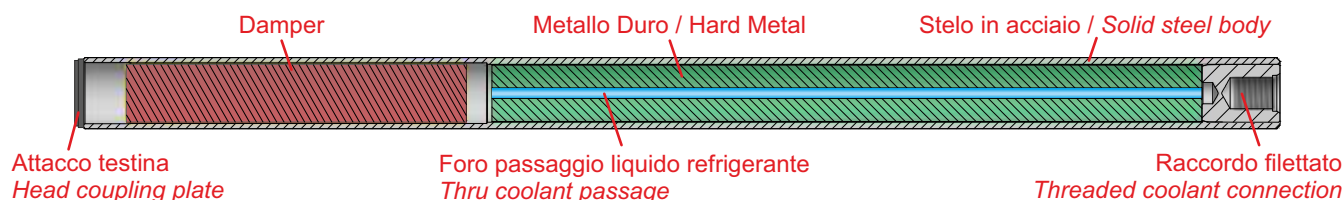

Linee di Testine / Line of Heads

- 2** **LINEE DI TESTINE** che si dividono principalmente in:
LINE OF HEADS that are mainly divided into:

1- CS20 - 12 modelli / models (destra e sinistra / right and left)

possono essere montate su barre di diametro 20 ,25, 32 mm
can be mounted on bars with 20, 25, 32 mm diameter

2- CS40 - 18 modelli / models (destra e sinistra / right and left)

possono essere montate su barre di diametro 40, 50, 60 mm
can be mounted on bars with 40, 50, 60 mm diameter

esempio di testina CS20
example of CS20 head



esempio di testina CS40
example of CS40 head



1 **SISTEMA DI ACCOPPIAMENTO TESTINE / HEAD COUPLING SYSTEM**

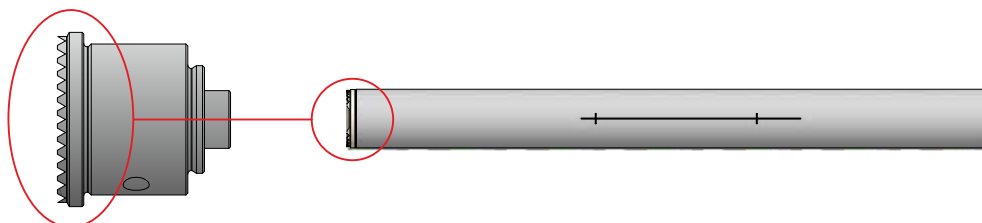

UNA TESTINA TRE BARRE DI DIVERSO DIAMETRO - MASSIMO ADATTAMENTO
ONE HEAD THREE BAR DIAMETERS - MAXIMUM FLEXIBILITY

La stessa testina può essere utilizzata su barre di diverso diametro, non c'è bisogno di cambiare testina per utilizzare barre più grandi.

The same head can be used on different diameter bars, no need to switch heads when using a bigger bar.

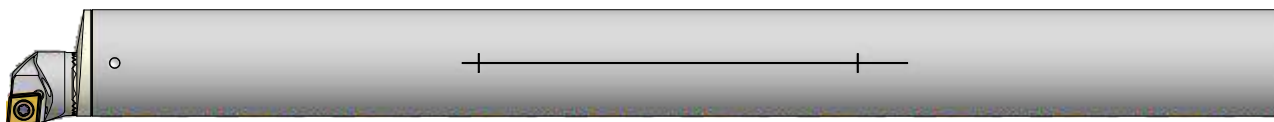
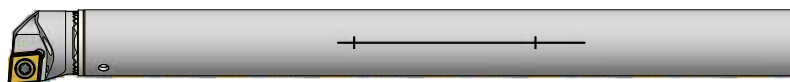

esempio di uno stesso modello di testina montato su tre barre di diametro diverso
example of the same head model mounted on three bars of different diameter

Caratteristiche delle Testine / Heads features

Come già detto uno stesso modello di testina può essere montato su diametri di barre diverse:

- Testine CS20 con barre di diametro 20, 25 e 32 mm
- Testine CS40 con barre di diametro 40, 50 e 60 mm

As already mentioned, the same head model can be mounted on different bars diameters:

- CS20 heads on bars with 20, 25 and 32 mm diameters
- CS40 heads on bars with 40, 50 and 60 mm diameters

L'unica accortezza è quella di assicurarsi che il diametro minimo di lavorazione sia rispettato. Uno spazio limitato all'interno del foro provocherà la formazione di trucioli, una scarsa qualità di lavorazione ed, eventualmente, danni.

Inoltre in base alla lavorazione da fare devono essere utilizzati determinati inserti.

The only caution is to make sure that the minimum machining diameter requirements are met. Limited space inside the hole will cause chip build up, bad machining quality and, possibly, damage.

Depending on the type of machining to be carried out the appropriate head geometry and insert should be used.

CS20 montano solo inserti positivi
only positive inserts are used

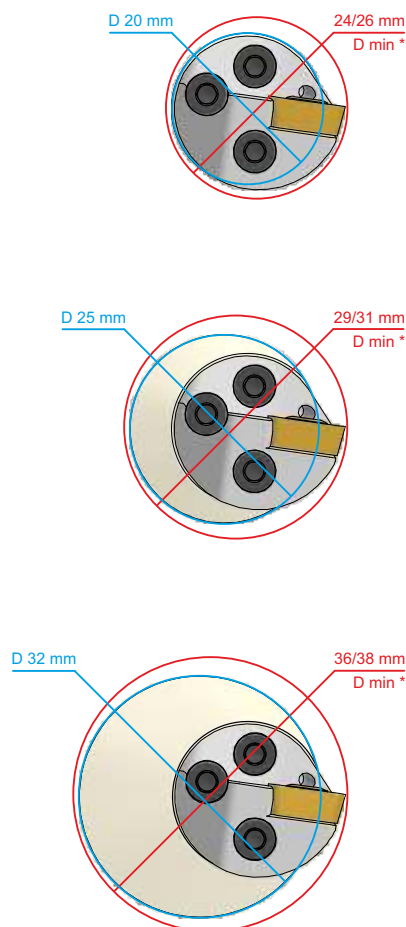

CS40 montano sia inserti positivi che negativi
both positive and negative inserts are used

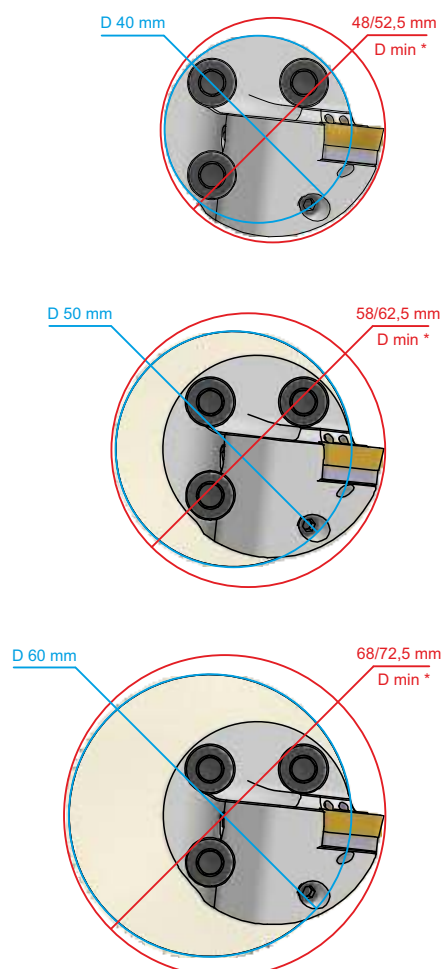

* Diametro minimo variabile in base al modello di testina / *The minimum diameter is variable according to the model of the head*

Metodo di bloccaggio della barra / Bar holding methods

PROPORZIONI DI SPORGENZA E BLOCCAGGIO

Le barre antivibranti **DABtool** hanno precisi valori da rispettare durante il processo di bloccaggio. Ad esempio, nel caso della barra 60 mm 10 x D la lunghezza totale della barra è di 840 mm e deve così suddividersi:

- 600 mm di sporgenza
- 240 mm per il bloccaggio

Se queste indicazioni e misure non vengono rispettate la capacità di smorzamento delle vibrazioni della barra viene meno ed il potenziale antivibrante non verrà espresso al massimo.

OVERHANG PROPORTIONS

DABtool antivibration bars must have a very precise overhang length. In the case of 60 mm 10 x D the overall length will be of 840mm so divided:

- 600 mm overhang
- 240 mm for clamping in collet

Going over suggested lengths will minimize vibration damping capabilities. Staying below suggested values means the full potential of the DABtool system bars will not be expressed.



esempio di bloccaggio con barra D 60 mm - 10 x D
example of holding method with D 60 mm - 10 x D bar

Ci sono 4 metodi di bloccaggio, alcuni non consoni per sfruttare al massimo il potenziale antivibrante delle barre ed altri eccellenti. Per bloccare e far rendere al meglio le barre DABtool i metodi migliori sono il 3° e il 4°, come da tabella:

There are 4 methods to hold the bars. DAB Tools suggests to use method 3 or 4 for the best possible results:

Descrizione Description	Vite Screw	Bussola Bushing	Portautensile Collar	Valutazione Rating
Un punto solo Single point	Singola Single	No No	Intero One piece	Non accettabile Not suitable
Un punto solo con bussola tagliata Single point with split bushing	Singola Single	Tagliata Split	Intero One piece	Accettabile Suitable
Più punti con portautensile tagliato Multipoint with split collar	Multiple Multiple	No No	Tagliato Split	Buono Good
Più punti con portautensile tagliato e bussola tagliata Multipoint with split collar and split bushing	Multiple Multiple	Tagliata Split	Tagliato Split	Ottimo Excellent

Metodo di bloccaggio della barra / Bar holding methods

Metodo non adatto / Not suitable method

SOLUZIONE #1 – NON ADATTA ALLO SMORZAMENTO DELLE VIBRAZIONI

Un singolo contatto che poggia direttamente sulla barra non offre sufficiente bloccaggio perché **il punto di contatto è solo 1**

SOLUTION #1 – NOT SUITABLE FOR EFFICIENT VIBRATION DAMPING

Single locking pushing directly on the bar. Will not offer sufficient hold as there is **only 1 contact point**

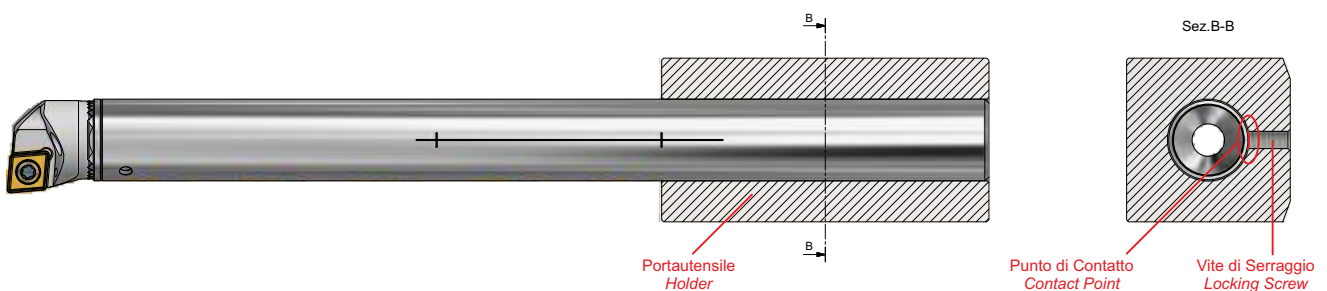

Metodo poco adatto / Suitable method

SOLUZIONE #2 – POCO ADATTA ALLO SMORZAMENTO DELLE VIBRAZIONI

Un singolo contatto che poggia sulla barra attraverso una BUSSOLA TAGLIATA. Nonostante il singolo contatto, la forza di serraggio è distribuita lungo la lunghezza della bussola tagliata.

Offre un sistema adatto, ma non perfetto, per lo smorzamento delle vibrazioni.

SOLUTION #2 – SUITABLE FOR VIBRATION DAMPING

Single locking pushing on the bar through a SPLIT BUSHING. Despite the single contact the clamping force is distributed along the length of the split bushing.

It offers a suitable system for vibration damping.

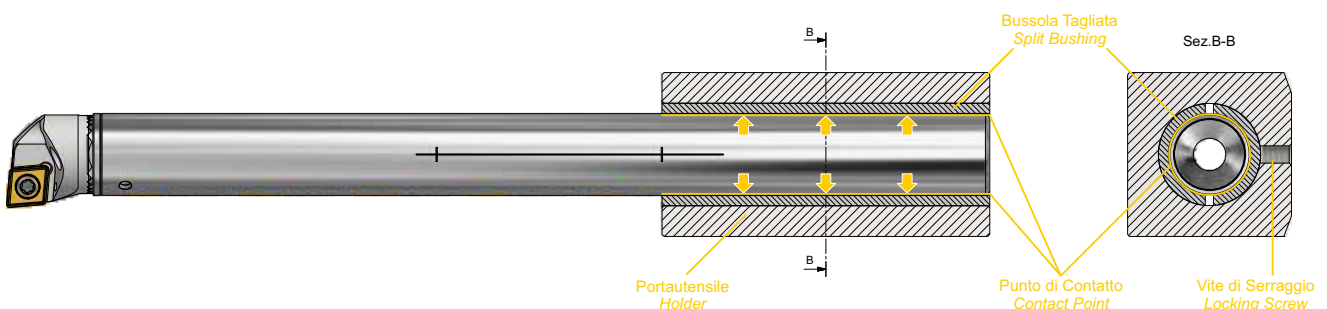

Metodo di bloccaggio della barra / Bar holding methods

Metodo buono / Good method

SOLUZIONE #3 – BUONA PER LO SMORZAMENTO DELLE VIBRAZIONI

Serraggio **MULTIPLO** grazie alle viti che bloccano la barra attraverso un COLLARE TAGLIATO. La forza di bloccaggio è uniformemente distribuita lungo la lunghezza del collare e sulla barra. **Questo metodo offre un buon sistema di smorzamento delle vibrazioni.**

SOLUTION #3 – GOOD FOR VIBRATION DAMPING

MULTIPLE locking screws pushing on the bar through a SPLIT COLLAR. The clamping force is evenly distributed along the length of the split collar and onto the bar. **It offers a good system for vibration damping.**

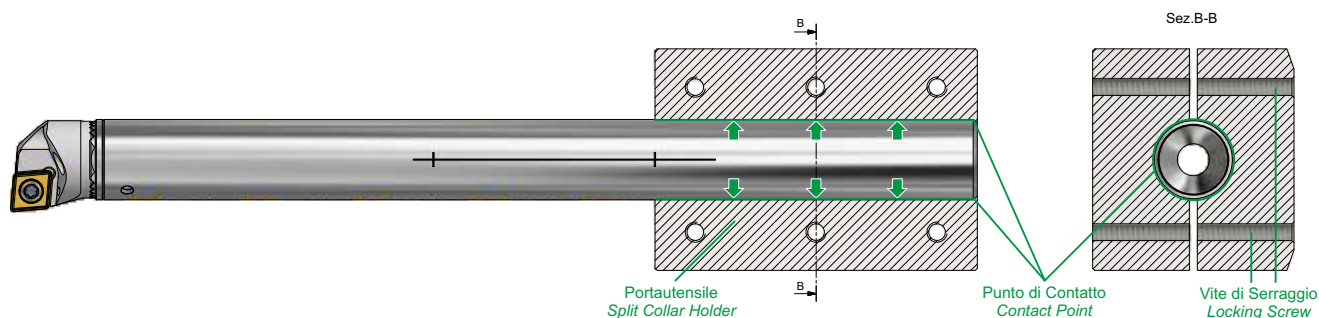

Metodo ottimale / Excellent method

SOLUZIONE #4 – OTTIMALE PER LO SMORZAMENTO DELLE VIBRAZIONI

Serraggio **MULTIPLO** grazie alle viti che bloccano la barra attraverso un COLLARE TAGLIATO e una BUSSOLA TAGLIATA. La forza di bloccaggio è uniformemente e ben distribuita su tutta la lunghezza del bussola. **Questo metodo è il migliore per lo smorzamento delle vibrazioni.**

SOLUTION #4 – EXCELLENT FOR VIBRATION DAMPING

MULTIPLE locking screws pushing on the bar through a SPLIT COLLAR and onto a SPLIT BUSHING. The clamping force is well distributed along the length of the split bushing. **It provides the best solution for vibration damping.**

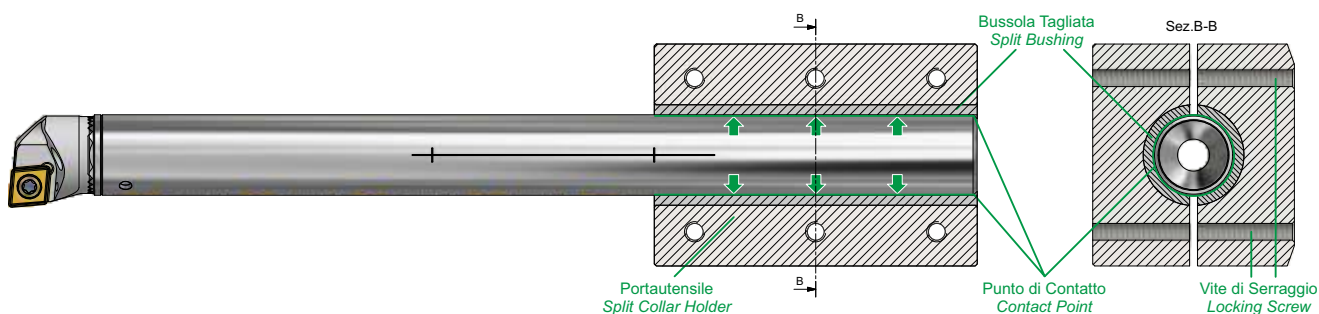

Metodo di centraggio della barra / Bar centering methods

Trovare il centraggio perfetto nelle barre antivibranti **DABtool** è molto semplice: basta regolarsi con linea tracciata sulla barra stessa e posizionarsi tra le due tacche limite.

Perfect centering in the **DABtool** anti-vibration bars is very simple: adjust with the line drawn on the bar and position between the two notches.

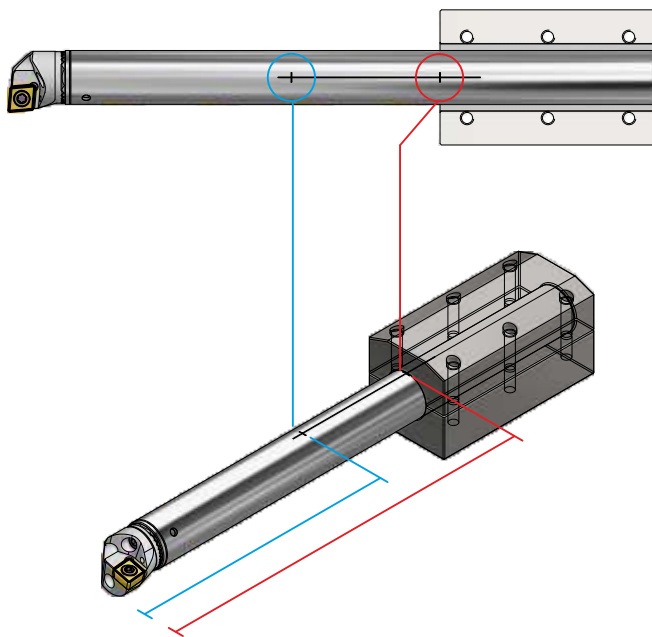

— punto di sporgenza minimo
minimum clamping point

— punto di sporgenza massimo
maximum clamping point

5 x D		
Ø mm	min	max
20	40	100
25	45	125
32	52	160
40	72	200
50	82	250
60	92	300

8 x D		
Ø mm	min	max
20	105	160
25	120	200
32	142	256
40	180	320
50	215	400
60	247	480

10 x D		
Ø mm	min	max
20	120	200
25	140	250
32	165	320
40	200	400
50	245	500
60	280	600

12 x D		
Ø mm	min	max
20	135	240
25	159	300
32	188	384
40	215	480
50	270	600
60	325	720

14 x D		
Ø mm	min	max
20	152	280
25	181	350
32	216	448
40	/	/
50	/	/
60	/	/

Massima performance / Best performance

Bisogna tenere in considerazione alcune variabili per essere certi che le barre antivibranti **DABtool** si esprimano al massimo del proprio potenziale.

Un metodo "a colpo d'occhio" è dato dalla "matrice di vibrazioni" che tiene conto di tutte le variabili potenziali che possono determinare le prestazioni della barra antivibrante.

La scelta di un inserto "sbagliato" nella sua geometria, nel raggio, nell'angolo di taglio e/o spoglia e le condizioni del tagliente influiscono negativamente sulla lavorazione.

Utilizzare il raggio più piccolo possibile dell'inserto per le lavorazioni, come:

- **V** per **profilatura e finitura**
- **D** per **lavorazioni generali**
- **T** per **sgrossatura superficiale e finitura**
- **C** per **sgrossatura profonda**

*Many variables must be taken into consideration to make sure your **DABtool** boring bars are always performing at the peak of their specifications.*

An "at a glance" method is given by the "vibration matrix" which takes into account all potential variables that can determine the antivibration bar's performance.

Choosing an "incorrect" insert in its geometry, radius, cut and / or blade angle and cutting edge conditions will adversely affect machining.

Use the smallest insert angle geometry for the operation, like:

- **V** for **profiling and finishing**
- **D** for **general application**
- **T** for **light roughing and finishing**
- **C** for **heavy roughing**

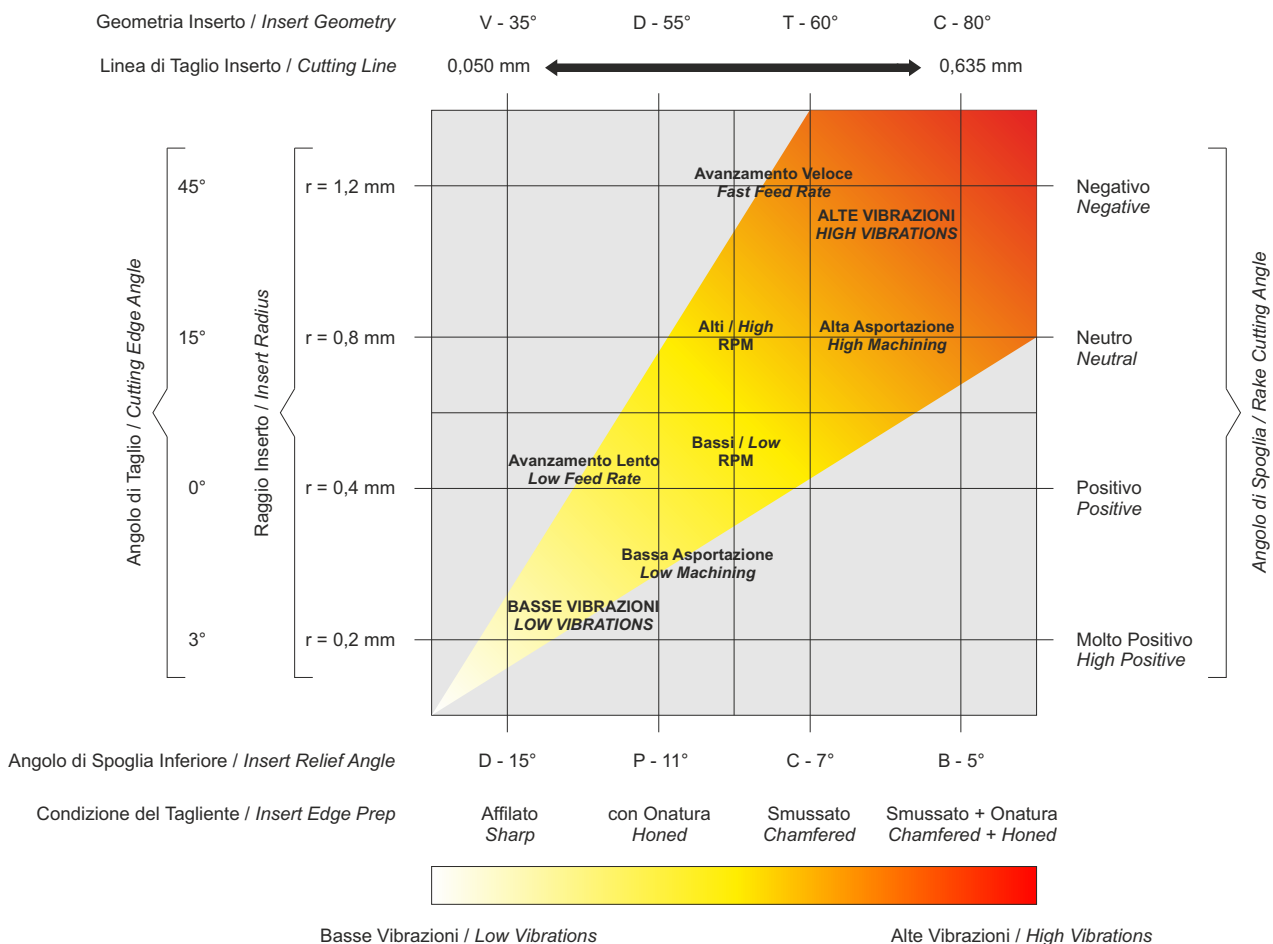

Progettazione e realizzazione / Design and production

LE BARRE **DABtool** SONO PROGETTATE, TESTATE E APPROVATE PER L'USO IN COMAND TOOL. TUTTI I PROCESSI SONO ESEGUITI ALL'INTERNO DELL'AZIENDA PER CONTROLLARE COSTANTEMENTE LA PRODUZIONE E GARANTIRE LA MASSIMA QUALITÀ.

THE **DABtool** ARE DESIGNED, ENGINEERED TESTED AND VALIDATED IN COMAD TOOL. PRODUCTION PROCESS IS KEPT WITHIN THE COMPANY TO MAINTAIN CONSTANT CONTROL OF QUALITY AND SPECIFICATION.



Comand Tool progetta e sviluppa ogni barra e ogni singola testina nei minimi dettagli. È necessaria la massima precisione per realizzarle, per questo il controllo è costante in tutte le fasi del processo di produzione.

Comand Tool designs, develops and engineers each bar and each head down to the last detail. When maximum precision is required bars and head must be seen through every step of production.

Frequent quality controls are carried out during all of the production process.



Le barre e le testine **DABtool** sono realizzate con sistemi tecnologici e utensili di ultima generazione. Tavole girevoli a 5 assi e centri di lavoro di ultima generazione consentono di produrre e assicurare altissima qualità alla linea **DABtool**.

Cutting edge technology for fast and precise production of DAB TOOL heads. 5 axis direct drive rotary tables, brand new machine tools and the most accurate positioning systems to ensure quality in every step of the production line.

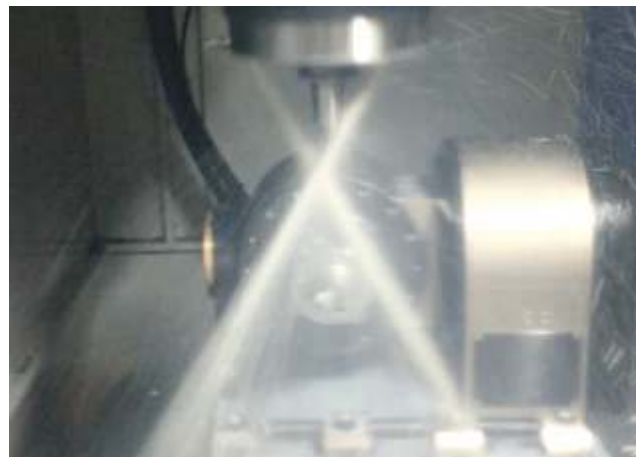

Test d'esempio / Example Test

DABtool utilizzata per il test **AFS50-10-668**:

700 mm lunghezza (D 50 - 10 x D)
500 mm - porzione di barra fuori dal bloccaggio

Tipo testina: CS40-STUCR-16

Inserto: TCMT16T304-CT4125

Lavorazione - Sgrossatura profonda

Diametro esterno pezzo: 120 mm

Diametro interno lavorato: 85 mm

Profondità di taglio (a_p): 1,5 mm

N° passate: 4

Velocità di taglio (v_c): 200 mt/min

Velocità di avanzamento (f_n): 0,2 mm

DABtool used for the test **AFS50-10-668**:

700 mm length (D 50 - 10 x D)

500 mm - portion of bar out of tool holder

Head: CS40-STUCR-16

Insert: TCMT16T304-CT4125

Machining - Deep grooving

External diameter: 120 mm

Internal diameter machining: 85 mm

Depth cut (a_p): 1,5 mm

Nr machining operations: 4

Cutting speed (v_c): 200 mt/min

Feed rate (f_n): 0,2 mm

RISULTATI:

Nonostante la difficoltà per ottenere buone finiture con l'acciaio **Fe510C** il risultato è stato molto positivo. La **manca** di vibrazioni e la **stabilità dell'utensile** hanno consentito di raggiungere **Ra 1,9** finitura.

Tipicamente i risultati di Ra da diversi processi di lavorazione sono i seguenti:

- Fresatura Ra 3,2
- Rettifica Ra 1,6
- Lappatura 0,8

Il test ha evidenziato come, con le barre **DABtool**, si possa ottenere fin da subito una lavorazione molto vicina ai valori della rettifica e quindi una superficie interna lavorata con ottimi risultati in sgrossatura e finitura, il tutto con un solo utensile.

RESULTS:

Despite the difficulty of achieving good finishes with Fe510C steel the result was very positive. Lack of vibrations and tool stability allowed to reach Ra 1,9 finish.

Typically Ra results from different machining processes are the following:

- Milling Ra 3,2
- Grinding Ra 1,6
- Honing 0,8

The test was a fraction above grinding process so **DABtool** managed to provide a machined internal surface with excellent values in finish and rough cutting, all with one tool.

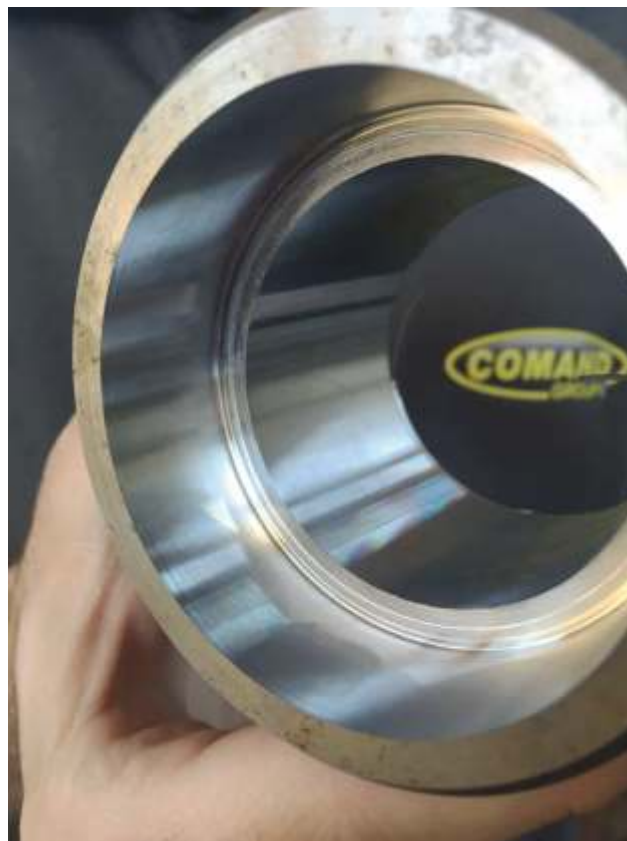

Chiave di lettura dei Codici - Barre / Code Key - Bars

esempio codice / example code

1	2	3	4	5	6
A	N	S	20	05	160

1 - Barra / Bar
A
Barra con Foro Refrigerazione Bars with Coolant Hole

2 - Caratteristiche Attacco / Shank's Features	
N	F
Senza Dispositivo Antivibrante Shank without Antivibration device	Con Dispositivo Antivibrante Shank with Antivibration device

3 - Materiale Attacco / Shank's Material	
S	H
Attacco in Acciaio Steel Shank	Metallo Duro all'interno Carbide Shank inside

4 - Diametro Barra / Shank's Diameter					
20	25	32	40	50	60
CS20			CS40		

5 - Lugh. Lavoro x D / Work Length for Diameter				
05	08	10	12	14
ANS...	AFS...	AFS...	AFH...	AFH...

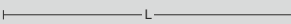
6 - Lunghezza Totale Barra / Total Tool Length













Chiave di lettura dei Codici - Testine / Code Key - Heads

esempio codice / example code



0	1	2	3	4	5	9
CS20	S	C	L	C	R	09



0 - Tipologia Testina / Heads Type	
CS20	CS40
...	...

1 - Sistema Bloccaggio / Clamping Type	
D 	S 
Staffa+Vite / Clamp+Screw	Vite / Screw

2 - Forma dell'Inserto / Insert Shape					
					
C - 80°	D - 55°	T - 60°	V - 35°	W - 80°	I - 60°

3 - Tipo di Attacco / Shank Type					
L	N	Q	R	U	X
95°	63°	15°	75°	93°	Special

4 - Angolo spoglia Inserto / Rake Angles	
C 	N 
C - 7°	N - 0°

5 - Lato Lavorazione / Machining Side	
R 	L 
Destra / Right	Sinistra / Left

9 - Lunghezza Tagliente / Cutting Edge Length											
C 	D 	T 	V 	W 	I 						
09	12	07	11	15	11	16	22	11	16	08	16

Icone / Icons



Passaggio refrigerante
Through coolant



Sottoplacchetta
Seat



Vite sottoplacchetta
Seat screw



Trucoli "no problem"
Chips "no problem"



Staffa
Clamp



Vite staffa
Clamp screw



Vibrazioni ridotte
Reduced vibrations



OR per CS20
OR for CS20



Vite a brugola
Hex screw



Intercambiabile
Interchangeable



OR Staffa
OR clamp



Bussola filettata
Bushing



Alta qualità
High quality



OR per CS40
OR for CS40



Vite torx
Torx screw



Alte prestazioni
High performance



Perno centraggio
Centering pin



Vite torx
Torx screw



Quick set
Quick set



Chiave a brugola
Hex key



Chiave torx
Torx key



Vite senza testa
Socket screw



Sfera refrigerazione
Through coolant sphere



Vite blocca sfera
Locking sphere



Damper
Damper



Metallo duro
Hard metal



Non tagliare
Don't cut





CS20 System



INDICE BARRE / BARS CONTENTS



ANS...05...
pag. A 19

AFS...08...
pag. A 19

AFS...10...
pag. A 20

AFH...12...
pag. A 20

AFH...14...
pag. A 21

Bussole Fissaggio Barra / Toolholder Bushing **BDT** - pag. A 44

INDICE TESTINE / HEADS CONTENTS



CS20-SCLCR/L-09
pag. A 22



CS20-SDNCR/L-11
pag. A 22



CS20-SDQCR/L-07
pag. A 23



CS20-SDQCR/L-11
pag. A 23



CS20-SDUCR/L-07
pag. A 24



CS20-SDUCR/L-11
pag. A 24



CS20-STUCR/L-11
pag. A 25



CS20-STUCR/L-16
pag. A 25



CS20-SDXCR/L-11
pag. A 26



CS20-SVUCR/L-11
pag. A 26



CS20-SIR/L-16
pag. A 27



CS20-XXR/L (Blank)
pag. A 27

ANS...-05-...

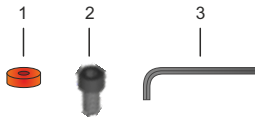
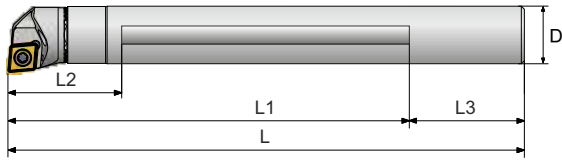

Le immagini raffigurano una barra D 20 / Pictures represent D 20 bar

Codice Articolo Item Code	Rapporto Boring Ratio	D	L	L1	L2	L3	M	Peso Weight
ANS20-05-160	5 x D	20	180	100	40	40	1/4 G	0,35 Kg
ANS25-05-205		25	225	130	45	50	1/4 G	0,73 Kg
ANS32-05-268		32	288	172	52	64	1/4 G	11,60 Kg

Parti di Ricambio / Spare Parts

1	2	3
CSC72 (5 pcs)	VB0308 (10 pcs)	CBR25

AFS...-08-...

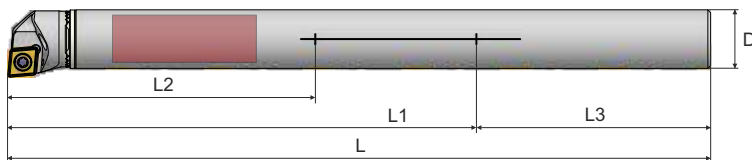

Le immagini raffigurano una barra D 20 / Pictures represent D 20 bar

Codice Articolo Item Code	Rapporto Boring Ratio	D	L	L1	L2	L3	M	Peso Weight
AFS20-08-220	8 x D	20	240	160	105	80	1/4 G	0,60 Kg
AFS25-08-280		25	300	200	120	100	1/4 G	1,10 Kg
AFS32-08-364		32	384	256	142	128	3/8 G	2,20 Kg

Parti di Ricambio / Spare Parts

1	2	3
CSC72 (5 pcs)	VB0308 (10 pcs)	CBR25

AFS...-10-...

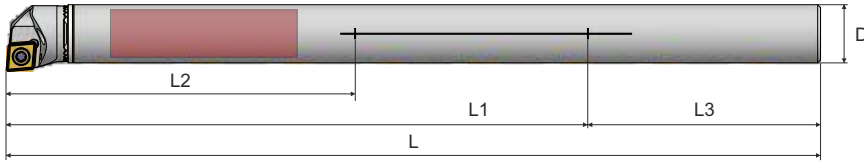

damper

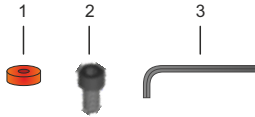

Le immagini raffigurano una barra D 20 / Pictures represent D 20 bar

Codice Articolo Item Code	Rapporto Boring Ratio	D	L	L1	L2	L3	M	Peso Weight
AFS20-10-260	10 x D	20	280	200	120	80	1/4 G	0,70 Kg
AFS25-10-330		25	350	250	140	100	1/4 G	1,30 Kg
AFS32-10-428		32	448	320	165	128	3/8 G	2,60 Kg

Parti di Ricambio / Spare Parts

1	2	3
CSC72 (5 pcs)	VB0308 (10 pcs)	CBR25

AFH...-12-...

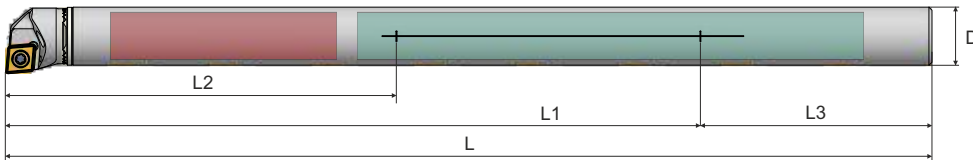

damper

metallo duro / hard metal



Le immagini raffigurano una barra D 20 / Pictures represent D 20 bar

Codice Articolo Item Code	Rapporto Boring Ratio	D	L	L1	L2	L3	M	Peso Weight
AFH20-12-300	12 x D	20	320	240	135	80	1/8 G	---
AFH25-12-380		25	400	300	159	100	1/4 G	---
AFH32-12-492		32	512	384	188	128	1/4 G	---

Parti di Ricambio / Spare Parts

1	2	3
CSC72 (5 pcs)	VB0308 (10 pcs)	CBR25

AFH...-14-...

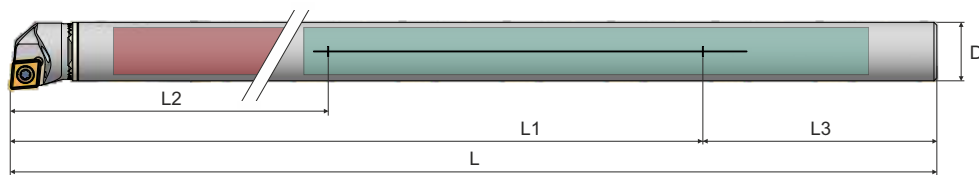

damper metallo duro / hard metal



1

2

3

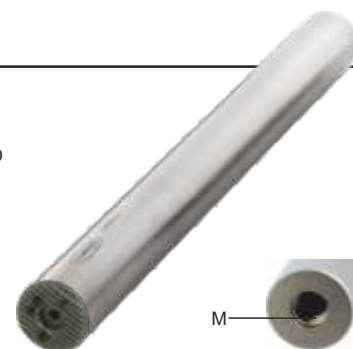

M

Le immagini raffigurano una barra D 20 / Pictures represent D 20 bar

Codice Articolo Item Code	Rapporto Boring Ratio	D	L	L1	L2	L3	M	Peso Weight
AFH20-14-340	14 x D	20	360	280	152	80	1/8 G	---
AFH25-14-430		25	450	350	181	100	1/4 G	---
AFH32-14-556		32	576	448	216	128	1/4 G	---

Parti di Ricambio / Spare Parts

1	2	3
CSC72 (5 pcs)	VB0308 (10 pcs)	CBR25

CS20-SCLCR/L-09

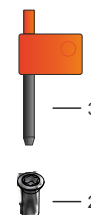
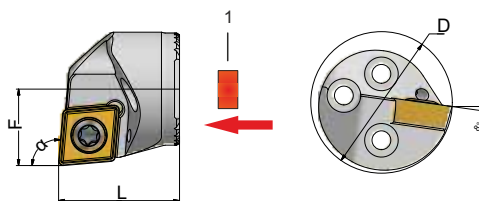

Le immagini raffigurano la testina destra / Pictures represent right head

Codice Articolo Item Code	Barra Bar	D	L	F	α	Inserto Insert	Peso Weight
CS20-SCLCR/L-09	A...20-...-	24	20,5	13	95°	CC...09T3	0,10 Kg
	A...25-...-	29					
	A...32-...-	36					

Parti di Ricambio / Spare Parts

1	2	3
CSC72 (5 pcs)	TX3509	BTX15

CS20-SDNCR/L-11

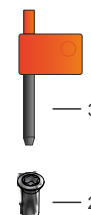
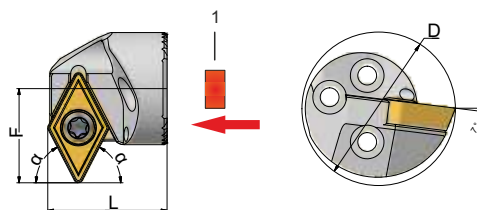

Le immagini raffigurano la testina destra / Pictures represent right head

Codice Articolo Item Code	Barra Bar	D	L	F	α	Inserto Insert	Peso Weight
CS20-SDNCR/L-11	A...20-...-	26	20,5	16	62,5°	DC...11T3	0,10 Kg
	A...25-...-	31					
	A...32-...-	38					

Parti di Ricambio / Spare Parts

1	2	3
CSC72 (5 pcs)	TX3509	BTX15

CS20-SDQCR/L-07

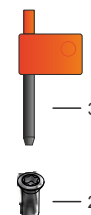
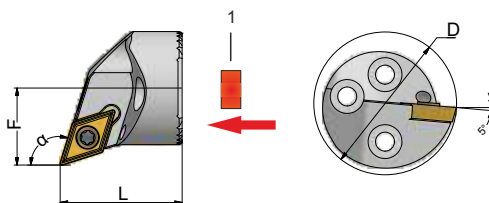

Le immagini raffigurano la testina destra / Pictures represent right head

Codice Articolo Item Code	Barra Bar	D	L	F	α	Inserto Insert	Peso Weight
CS20-SDQCR/L-07	A...20-...-	24					
	A...25-...-	29	20,5	13	107,5°	DC...0702	0,10 Kg
	A...32-...-	36					

Parti di Ricambio / Spare Parts

1	2	3
CSC72 (5 pcs)	TX2506	BTX08

CS20-SDQCR/L-11

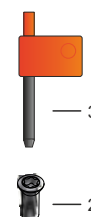
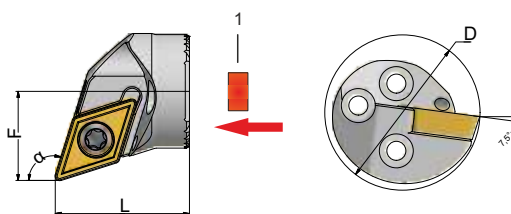

Le immagini raffigurano la testina destra / Pictures represent right head

Codice Articolo Item Code	Barra Bar	D	L	F	α	Inserto Insert	Peso Weight
CS20-SDQCR/L-11	A...20-...-	26					
	A...25-...-	31	22,5	15	107,5°	DC...11T3	0,10 Kg
	A...32-...-	38					

Parti di Ricambio / Spare Parts

1	2	3
CSC72 (5 pcs)	TX3509	BTX15

CS20-SDUCR/L-07

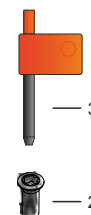
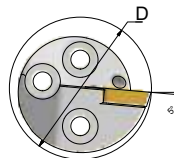
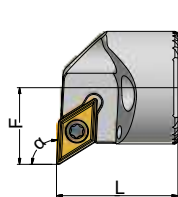

Le immagini raffigurano la testina destra / Pictures represent right head

Codice Articolo Item Code	Barra Bar	D	L	F	α	Inserto Insert	Peso Weight
CS20-SDUCR/L-07	A...20-...-	24	20,5	13	93°	DC...0702	0,10 Kg
	A...25-...-	29					
	A...32-...-	36					

Parti di Ricambio / Spare Parts

1	2	3
CSC72 (5 pcs)	TX2506	BTX08

CS20-SDUCR/L-11

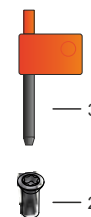
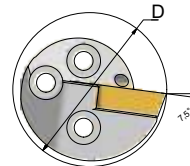
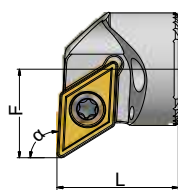

Le immagini raffigurano la testina destra / Pictures represent right head

Codice Articolo Item Code	Barra Bar	D	L	F	α	Inserto Insert	Peso Weight
CS20-SDUCR/L-11	A...20-...-	26	20,5	15	93°	DC...11T3	0,10 Kg
	A...25-...-	31					
	A...32-...-	38					

Parti di Ricambio / Spare Parts

1	2	3
CSC72 (5 pcs)	TX3509	BTX15

CS20-STUCR/L-11

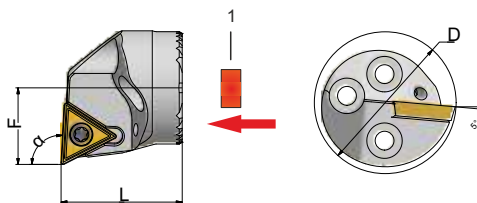

Le immagini raffigurano la testina destra / Pictures represent right head

Codice Articolo Item Code	Barra Bar	D	L	F	α	Inserto Insert	Peso Weight
CS20-STUCR/L-11	A...20-...-...	24					
	A...25-...-...	29	20,5	13	93°	TC...1102	0,10 Kg
	A...32-...-...	36					

Parti di Ricambio / Spare Parts

1	2	3
CSC72 (5 pcs)	TX2506	BTX08

CS20-STUCR/L-16

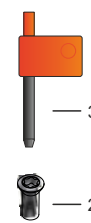
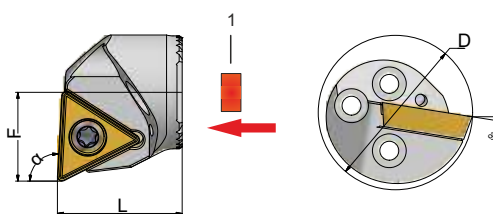

Le immagini raffigurano la testina destra / Pictures represent right head

Codice Articolo Item Code	Barra Bar	D	L	F	α	Inserto Insert	Peso Weight
CS20-STUCR/L-16	A...20-...-...	26					
	A...25-...-...	31	21	15	93°	TC...16T3	0,10 Kg
	A...32-...-...	38					

Parti di Ricambio / Spare Parts

1	2	3
CSC72 (5 pcs)	TX3509	BTX15

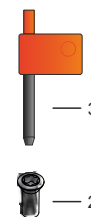
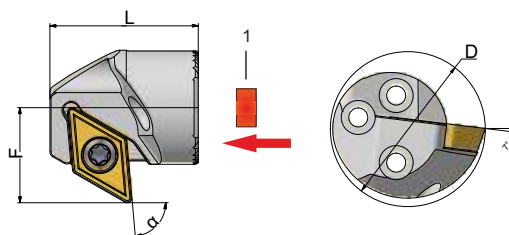

CS20-SDXCR/L-11



Le immagini raffigurano la testina destra / Pictures represent right head

Codice Articolo Item Code	Barra Bar	D	L	F	α	Inserto Insert	Peso Weight
CS20-SDXCR/L-11	A...20-...-...	26					
	A...25-...-...	31	25	16	85°	DC...11T3	0,10 Kg
	A...32-...-...	38					

Parti di Ricambio / Spare Parts

1	2	3
		
CSC72 (5 pcs)	TX3509	BTX15

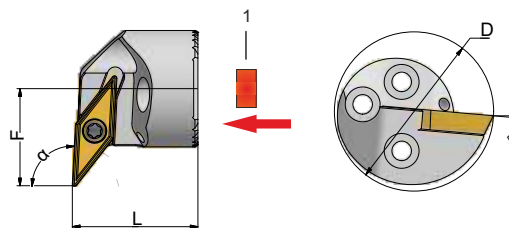

CS20-SVUCR/L-11



Le immagini raffigurano la testina destra / Pictures represent right head

Codice Articolo Item Code	Barra Bar	D	L	F	α	Inserto Insert	Peso Weight
CS20-SVUCR/L-11	A...20-...-...	26					
	A...25-...-...	31	20,5	16	93°	VC...1103	0,10 Kg
	A...32-...-...	38					

Parti di Ricambio / Spare Parts

1	2	3
		
CSC72 (5 pcs)	TX2506	BTX08

CS20-SIR/L-16

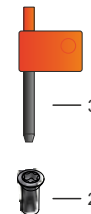
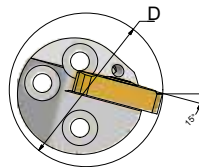
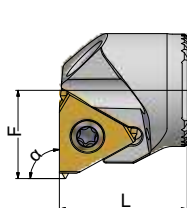

Le immagini raffigurano la testina destra / Pictures represent right head

Codice Articolo Item Code	Barra Bar	D	L	F	α	Inserto Insert	Peso Weight
CS20-SIR/L-16	A...20-...-...	26	21,7	15	90°	16 IR...	0,10 Kg
	A...25-...-...	31					
	A...32-...-...	38					

Parti di Ricambio / Spare Parts

1	2	3
CSC72 (5 pcs)	TX3509	BTX15

CS20-XXR/L

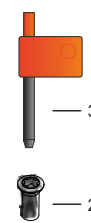
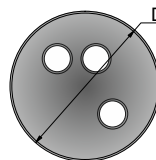

Le immagini raffigurano la testina destra / Pictures represent right head

Codice Articolo Item Code	Barra Bar	D	L	F	α	Inserto Insert	Peso Weight
CS20-XXR/L	A...20-...-...	29	24,8°	...	0,10 Kg
	A...25-...-...	29					
	A...32-...-...	29					

Parti di Ricambio / Spare Parts

1	2	3
CSC72 (5 pcs)	TX3509	BTX15



CS40 System



INDICE BARRE / BARS CONTENTS

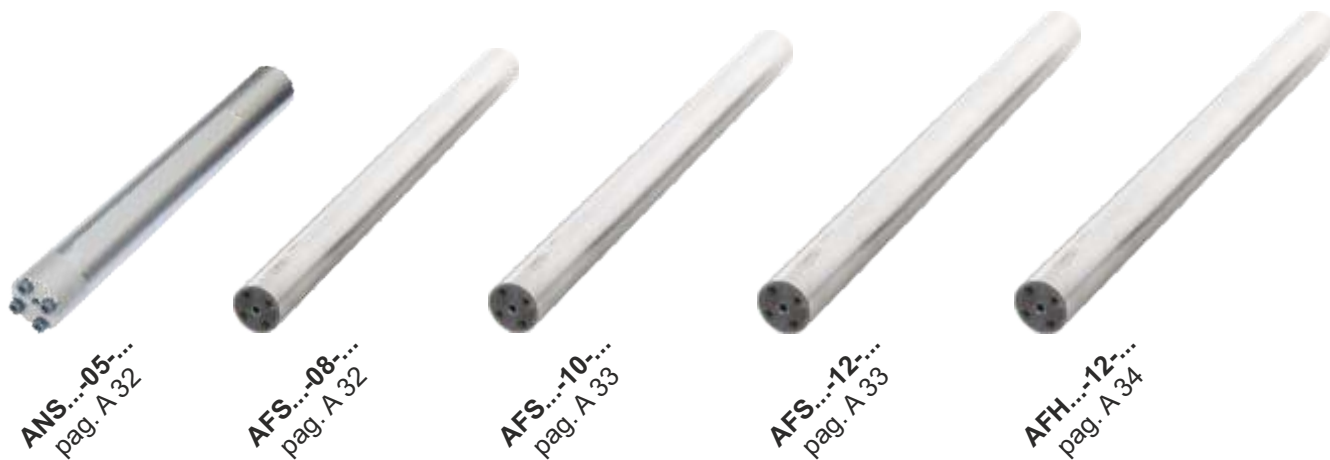

Bussole Fissaggio Barra / Toolholder Bushing **BDT** - pag. A 44

INDICE TESTINE / HEADS CONTENTS



CS40-DCLNR/L-12
pag. A 35



CS40-DDQNR/L-15
pag. A 35



CS40-DDUNR/L-15
pag. A 36



CS40-DTUNR/L-16
pag. A 36



CS40-DTUNR/L-22
pag. A 37



CS40-DWLNR/L-08
pag. A 37



CS40-SCLCR/L-12
pag. A 38



CS40-SDQCR/L-11
pag. A 38



CS40-SDUCR/L-11
pag. A 39



CS40-STUCR/L-16
pag. A 39



CS40-SVUCR/L-16
pag. A 40



CS40-DIR/L-16
pag. A 40
Filettatura / Threading

INDICE TESTINE SPECIALI / SPECIAL HEADS CONTENTS



CS40-PU10R/L
pag. A 41



CS40-XXR/L (Blank)
pag. A 41

INDICE TESTINE SCANALATURA / GROOVING HEADS CONTENTS



CS40-CIGR/L-20-11
pag. A 42



CS40-CIGR/L-30-11
pag. A 42



CS40-CIGR/L-40-11
pag. A 43



CS40-CIGR/L-50-11
pag. A 43

CS40-CIGR/L-...-11 Montaggio e Posizionamento Inserto / Mounting and Replacing Inserts

①

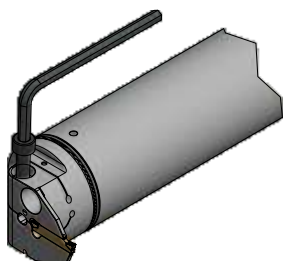

Svitare la vite sopra con l'apposita chiave
Unlock the top screw using the key provided.

②

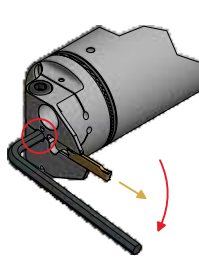

Posizionare la stessa chiave nella sede.
Ruotare la chiave per sbloccare la sede per rimuovere e sostituire l'inserto.
Place the same key in the "pocket."
Turn and hold the key to loosen the pocket.
Remove and replace the insert.

③

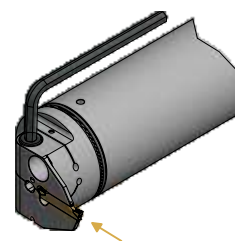

Ora rimuovere la chiave dalla sede e bloccare l'inserto avvitando la vite sopra
Now remove the key from the pocket and secure the insert by firmly locking the top screw.

ANS...-05-...

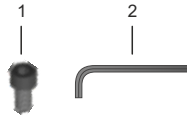
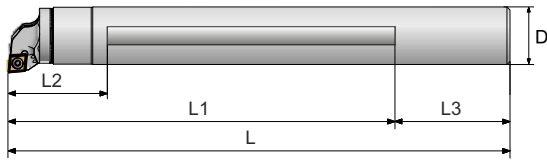

Le immagini raffigurano una barra D 40 / Pictures represent D 40 bar

Codice Articolo Item Code	Rapporto Boring Ratio	D	L	L1	L2	L3	M	Peso Weight
ANS40-05-328	5 x D	40	360	280	72	80	1/2 G	2,60 Kg
ANS50-05-418		50	450	350	82	100	1/2 G	5,70 Kg
ANS60-05-508		60	540	420	92	120	1/2 G	10,25 Kg

Parti di Ricambio / Spare Parts

1	2
VB0612 (10 pcs)	CBR50

AFS...-08-...

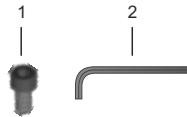
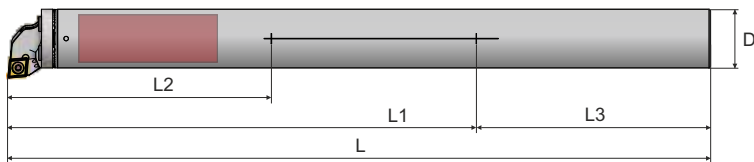

Le immagini raffigurano una barra D 40 / Pictures represent D 40 bar

Codice Articolo Item Code	Rapporto Boring Ratio	D	L	L1	L2	L3	M	Peso Weight
AFS40-08-448	8 x D	40	480	320	180	160	1/2 G	4,00 Kg
AFS50-08-568		50	600	400	215	200	1/2 G	8,20 Kg
AFS60-08-688		60	720	480	247	240	1/2 G	14,60 Kg

Parti di Ricambio / Spare Parts

1	2
VB0612 (10 pcs)	CBR50

AFS...-10-...

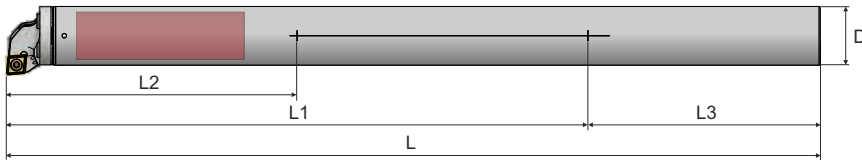

 damper

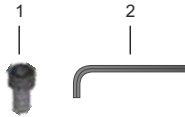

Le immagini raffigurano una barra D 40 / Pictures represent D 40 bar

Codice Articolo Item Code	Rapporto Boring Ratio	D	L	L1	L2	L3	M	Peso Weight
AFS40-10-528	10 x D	40	560	400	200	160	1/2 G	5,30 Kg
AFS50-10-668		50	700	500	245	200	1/2 G	11,00 Kg
AFS60-10-808		60	840	600	280	240	1/2 G	13,00 Kg

Parti di Ricambio / Spare Parts

	1		2
VB0612 (10 pcs)		CBR50	

AFS...-12-...

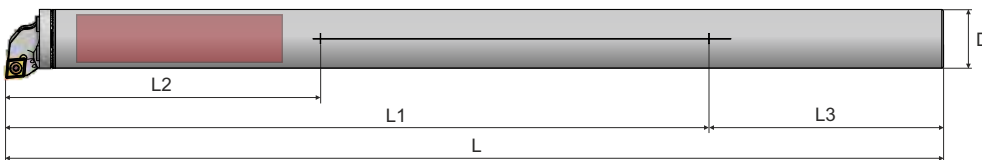

 damper

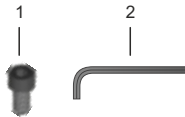

Le immagini raffigurano una barra D 40 / Pictures represent D 40 bar

Codice Articolo Item Code	Rapporto Boring Ratio	D	L	L1	L2	L3	M	Peso Weight
AFS40-12-608	12 x D	40	640	480	215	160	1/2 G	6,50 Kg
AFS50-12-768		50	800	600	270	200	1/2 G	13,00 Kg
AFS60-12-928		60	960	720	325	240	1/2 G	23,00 Kg

Parti di Ricambio / Spare Parts

	1		2
VB0612 (10 pcs)		CBR50	

AFH...-12-...

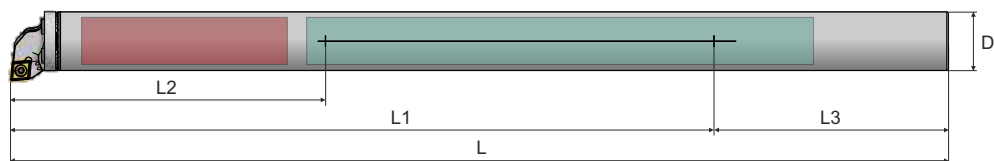

■ damper ■ metallo duro / hard metal

HQ **HP**

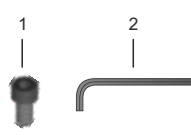

Le immagini raffigurano una barra D 40 / Pictures represent D 40 bar

Codice Articolo Item Code	Rapporto Boring Ratio	D	L	L1	L2	L3	M	Peso Weight
AFH40-12-608	12 x D	40	640	480	215	160	1/2 G	---
AFH50-12-768		50	800	600	270	200	1/2 G	---
AFH60-12-928		60	960	720	325	240	1/2 G	---

Parti di Ricambio / Spare Parts	
 1 VB0612 (10 pcs)	 2 CBR50

CS40-DCLNR/L-12

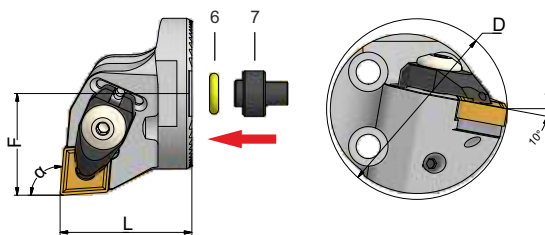

Le immagini raffigurano la testina destra / Pictures represent right head

Codice Articolo Item Code	Barra Bar	D	L	F	α	Inserto Insert	Peso Weight
CS40-DCLNR/L-12	A...40-...-	48	35,0	27	95°	CN...1204	0,20 Kg
	A...50-...-	58					
	A...60-...-	68					

Parti di Ricambio / Spare Parts

S8012P	VD0408	OR-SET (10+10 pcs)	DT21R/L	V6017	OR-CS40 (5 pcs)	DM-05-000	CBR30

CS40-DDQNR/L-15

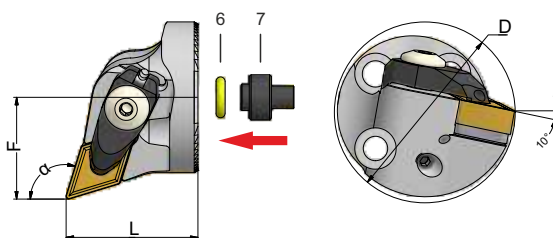

Le immagini raffigurano la testina destra / Pictures represent right head

Codice Articolo Item Code	Barra Bar	D	L	F	α	Inserto Insert	Peso Weight
CS40-DDQNR/L-15	A...40-...-	48	35,0	27	107,5°	DN...1506	0,20 Kg
	A...50-...-	58					
	A...60-...-	68					

Parti di Ricambio / Spare Parts

S5515D	VD0408	OR-SET (10+10 pcs)	DT22R/L	V6017	OR-CS40 (5 pcs)	DM-05-000	CBR30

CS40-DDUNR/L-15

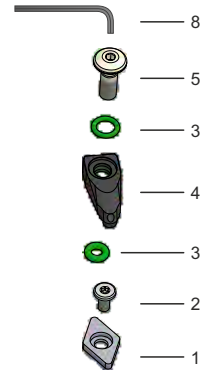
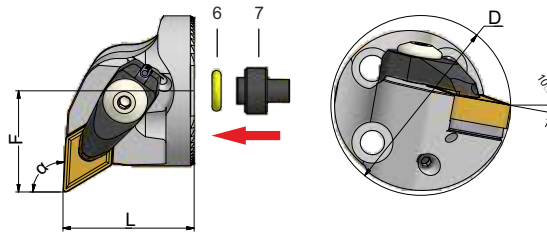

Le immagini raffigurano la testina destra / Pictures represent right head

Codice Articolo Item Code	Barra Bar	D	L	F	α	Inserto Insert	Peso Weight
CS40-DDUNR/L-15	A...40-...-	48	35,0	27	93°	DN...1506	0,20 Kg
	A...50-...-	58					
	A...60-...-	68					

Parti di Ricambio / Spare Parts

S5515D	VD0408	OR-SET (10+10 pcs)	DT22N	V6017	OR-CS40 (5 pcs)	DM-05-000	CBR30

CS40-DTUNR/L-16

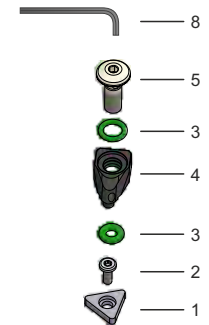
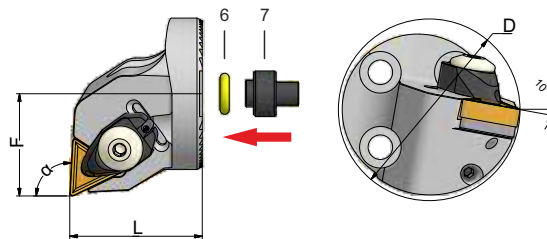

Le immagini raffigurano la testina destra / Pictures represent right head

Codice Articolo Item Code	Barra Bar	D	L	F	α	Inserto Insert	Peso Weight
CS40-DTUNR/L-16	A...40-...-	48	35,0	27	107,5°	TN...1604	0,20 Kg
	A...50-...-	58					
	A...60-...-	68					

Parti di Ricambio / Spare Parts

S6016D	VD0308	OR-SET (10+10 pcs)	DT23R/L	V6017	OR-CS40 (5 pcs)	DM-05-000	CBR30

CS40-DTUNR/L-22

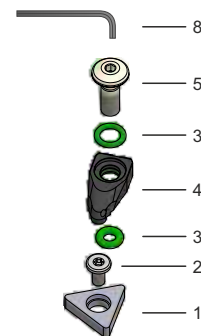
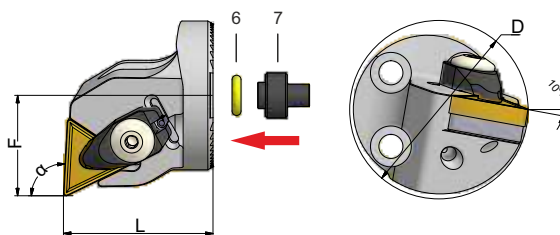

Le immagini raffigurano la testina destra / Pictures represent right head

Codice Articolo Item Code	Barra Bar	D	L	F	α	Inserto Insert	Peso Weight
CS40-DTUNR/L-22	A...40-...-	48					
	A...50-...-	58	40,0	27	93°	TN...22	0,20 Kg
	A...60-...-	68					

Parti di Ricambio / Spare Parts

S6022D	VD0408	OR-SET (10+10 pcs)	DT21R/L	V6017	OR-CS40 (5 pcs)	DM-05-000	CBR30

CS40-DWLNR/L-08

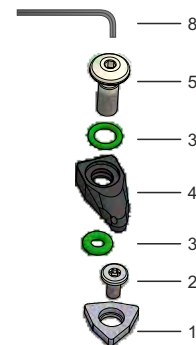
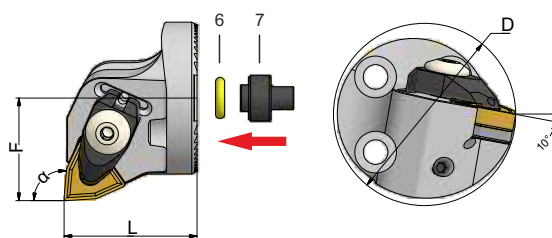

Le immagini raffigurano la testina destra / Pictures represent right head

Codice Articolo Item Code	Barra Bar	D	L	F	α	Inserto Insert	Peso Weight
CS40-DWLNR/L-08	A...40-...-	48					
	A...50-...-	58	35,0	27	95°	WN...0804	0,20 Kg
	A...60-...-	68					

Parti di Ricambio / Spare Parts

S8008P	VD0408B	OR-SET (10+10 pcs)	DT21R/L	V6017	OR-CS40 (5 pcs)	DM-05-000	CBR30



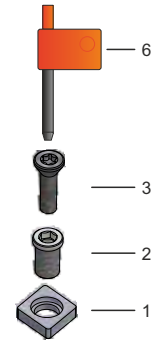
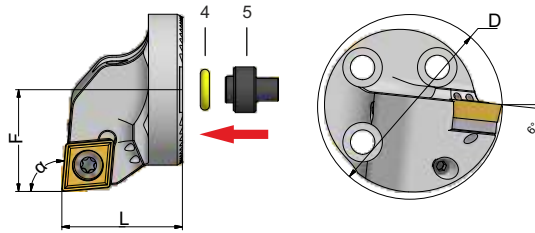



CS40-SCLCR/L-12



Le immagini raffigurano la testina destra / Pictures represent right head

Codice Articolo Item Code	Barra Bar	D	L	F	α	Inserto Insert	Peso Weight
CS40-SCLCR/L-12	A...40-...-	49	32,0	27	95°	CC...1204	0,20 Kg
	A...50-...-	59					
	A...60-...-	69					

Parti di Ricambio / Spare Parts

							
S8012P	B0609	TX4014	OR-CS40 (5 pcs)	DM-05-000	BTX15		



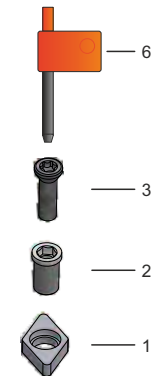
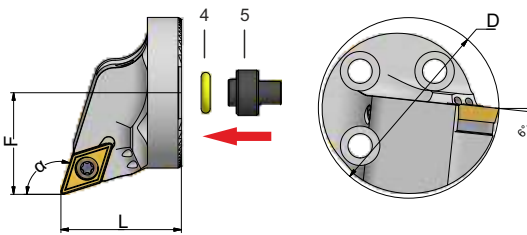



CS40-SDQCR/L-11



Le immagini raffigurano la testina destra / Pictures represent right head

Codice Articolo Item Code	Barra Bar	D	L	F	α	Inserto Insert	Peso Weight
CS40-SDQCR/L-11	A...40-...-	48	32,0	27	107,5°	DC...11T3	0,20 Kg
	A...50-...-	58					
	A...60-...-	68					

Parti di Ricambio / Spare Parts

							
S5511P	B0509	TX3513	OR-CS40 (5 pcs)	DM-05-000	BTX15		

CS40-SDUCR/L-11

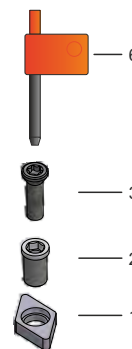
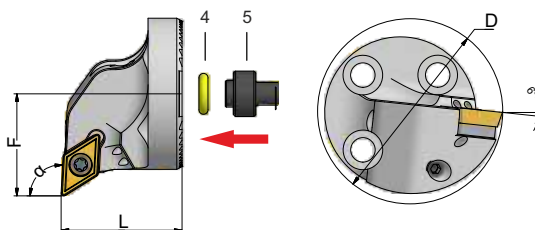

Le immagini raffigurano la testina destra / Pictures represent right head

Codice Articolo Item Code	Barra Bar	D	L	F	α	Inserto Insert	Peso Weight
CS40-SDUCR/L-11	A...40-...-	49	32,0	27	93°	DC...11T3	0,20 Kg
	A...50-...-	59					
	A...60-...-	69					

Parti di Ricambio / Spare Parts

S5511P	B0509	TX3513	OR-CS40 (5 pcs)	DM-05-000	BTX15		

CS40-STUCR/L-16

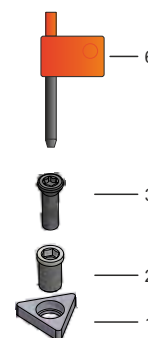
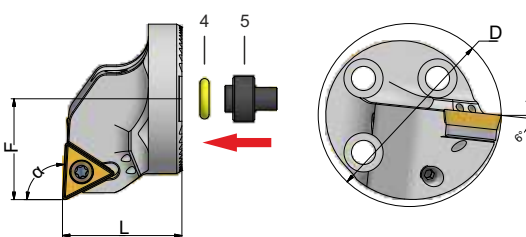

Le immagini raffigurano la testina destra / Pictures represent right head

Codice Articolo Item Code	Barra Bar	D	L	F	α	Inserto Insert	Peso Weight
CS40-STUCR/L-16	A...40-...-	49	32,0	27	93°	TC...16T3	0,20 Kg
	A...50-...-	59					
	A...60-...-	69					

Parti di Ricambio / Spare Parts

S6016P	B0509	TX3513	OR-CS40 (5 pcs)	DM-05-000	BTX15		

CS40-SVUCR/L-16

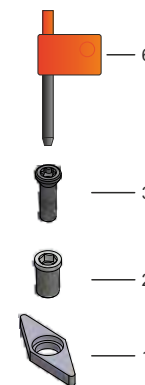
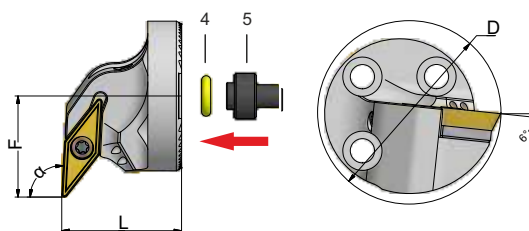

Le immagini raffigurano la testina destra / Pictures represent right head

Codice Articolo Item Code	Barra Bar	D	L	F	α	Inserto Insert	Peso Weight
CS40-SVUCR/L-16	A...40-...-	49					
	A...50-...-	59	32,0	27	93°	VC...1604	0,20 Kg
	A...60-...-	69					

Parti di Ricambio / Spare Parts

S3516P	B0509	TX3513	OR-CS40 (5 pcs)	DM-05-000	BTX15		

CS40-DIR/L-16

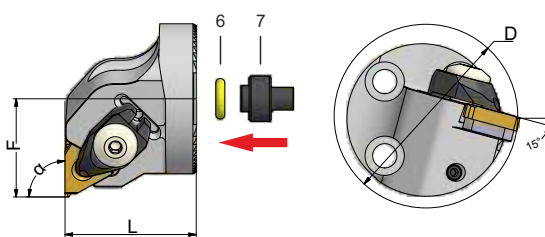

Le immagini raffigurano la testina destra / Pictures represent right head

Codice Articolo Item Code	Barra Bar	D	L	F	α	Inserto Insert	Peso Weight
CS40-DIR/L-16	A...40-...-	49					
	A...50-...-	59	35,0	26	90°	16 IR...	0,20 Kg
	A...60-...-	69					

Parti di Ricambio / Spare Parts

S6016R	TX4007	OR-SET (10+10 pcs)	DT24R/L	V6017	OR-CS40 (5 pcs)	DM-05-000	CBR30

CS40-PU10R/L

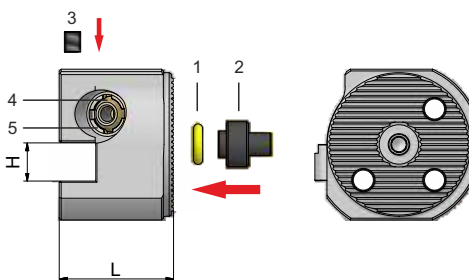

Le immagini raffigurano la testina destra / Pictures represent right head

Codice Articolo Item Code	Barra Bar	D *	L	H	α	Utensile Tool	Peso Weight
CS40-PU10R/L	A...40-...-...	...	32,0	10	...°	1010	0,20 Kg
	A...50-...-...	...					
	A...60-...-...	...					

Parti di Ricambio / Spare Parts

1	2	3	4	5
OR-CS40 (5 pcs)	DM-05-000	GR0620	SF13990	BS13989

* Diametro minimo "D" variabile a seconda della posizione dell'utensile / Minimum diameter "D" can vary depending on tool position

CS40-XXR/L

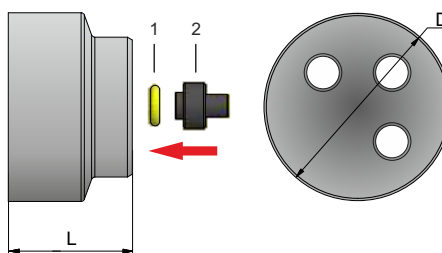

Le immagini raffigurano la testina destra / Pictures represent right head

Codice Articolo Item Code	Barra Bar	D	L	F	α	Inserto Insert	Peso Weight
CS40-XXR/L	A...40-...-...	54	36,0°	...	0,20 Kg
	A...50-...-...	54					
	A...60-...-...	54					

Parti di Ricambio / Spare Parts

1	2
OR-CS40 (5 pcs)	DM-05-000

CS40-CIGR/L-20-11

Utilizzare solo con barra ANS...-05-... max 3 x D
Use only with ANS bar ...- 05 -... max 3 x D

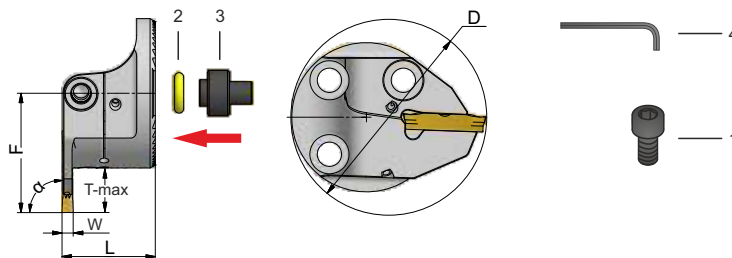

Le immagini raffigurano la testina destra / Pictures represent right head

Codice Articolo Item Code	Barra Bar	D	L	F	α	W	T-max	Inserto Insert	Peso Weight
CS40-CIGR/L-20-11	A...40-...-...	52,5	25,0	32	90°	2,0	11	CTSN 22-20	0,20 Kg
	A...50-...-...	62,5							
	A...60-...-...	72,5							

Parti di Ricambio / Spare Parts									
VB0518	OR-CS40 (5 pcs)	DM-05-000	CBR40						

CS40-CIGR/L-30-11

Utilizzare solo con barra ANS...-05-... max 3 x D
Use only with ANS bar ...- 05 -... max 3 x D

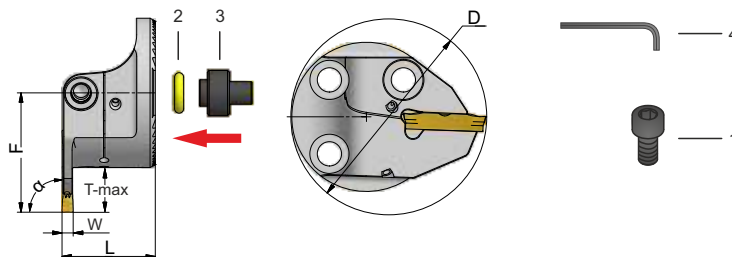

Le immagini raffigurano la testina destra / Pictures represent right head

Codice Articolo Item Code	Barra Bar	D	L	F	α	W	T-max	Inserto Insert	Peso Weight
CS40-CIGR/L-30-11	A...40-...-...	52,5	25,0	32	90°	3,0	11	CTSN 22-30	0,20 Kg
	A...50-...-...	62,5							
	A...60-...-...	72,5							

Parti di Ricambio / Spare Parts									
VB0518	OR-CS40 (5 pcs)	DM-05-000	CBR40						

CS40-CIGR/L-40-11

Utilizzare solo con barra ANS...-05-... max 3 x D
Use only with ANS bar ...- 05 -... max 3 x D

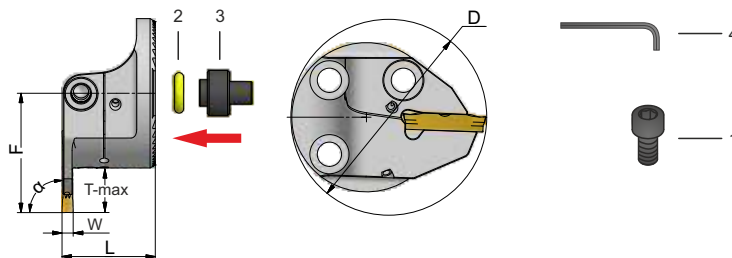

Le immagini raffigurano la testina destra / Pictures represent right head

Codice Articolo Item Code	Barra Bar	D	L	F	α	W	T-max	Inserto Insert	Peso Weight
CS40-CIGR/L-40-11	A...40-...-...	52,5							
	A...50-...-...	62,5	25,0	32	90°	4,0	11	CTSN 25-40	0,20 Kg
	A...60-...-...	72,5							

Parti di Ricambio / Spare Parts

VB0518	OR-CS40 (5 pcs)	DM-05-000	CBR40						

CS40-CIGR/L-50-11

Utilizzare solo con barra ANS...-05-... max 3 x D
Use only with ANS bar ...- 05 -... max 3 x D

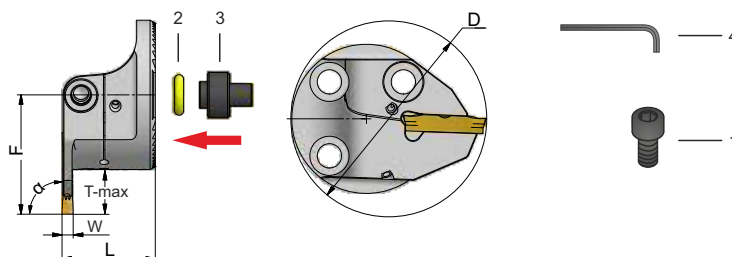

Le immagini raffigurano la testina destra / Pictures represent right head

Codice Articolo Item Code	Barra Bar	D	L	F	α	W	T-max	Inserto Insert	Peso Weight
CS40-CIGR/L-50-11	A...40-...-...	52,5							
	A...50-...-...	62,5	25,0	32	90°	5,0	11	CTSN 25-50	0,20 Kg
	A...60-...-...	72,5							

Parti di Ricambio / Spare Parts

VB0518	OR-CS40 (5 pcs)	DM-05-000	CBR40						

BDT

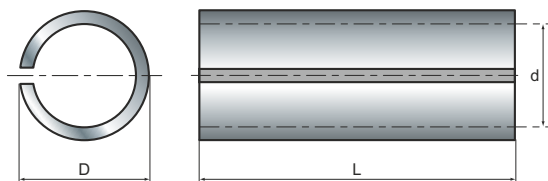

Codice Articolo Item Code	D Diametro Esterno / External Diameter	d Diametro Interno / Internal Diameter	L Length
BDT 2520-080	25	20	80
BDT 3225-100	32	25	100
BDT 4032-128	40	32	128
BDT 5040-160	50	40	160
BDT 6050-200	60	50	200

Caratteristiche Generali / Technical Data

Le **Bussole di Bloccaggio Barra** consentono il corretto fissaggio delle **Barre Antivibranti DABtool** su portautensili.
*The **Toolholder Bushing** allow **DABtool Antivibrations Bar** to be fixed to the toolholders of the machine tools.*

Tabelle di riepilogo / Summary tables

MASSIMA SPORGENZA RACCOMANDATA / MAXIMUM OVERHANG RECOMMENDED

Tipo di Barra / Bar Type DABtool		Tornitura Turning	Scanalatura Grooving	Filettatura Threading
ANS...	Barre Alesatura Acciaio <i>Boring Steel Bars</i>	5 x dm_m	3 x dm_m	3 x dm_m
AFS...	Barre Alesatura Antivibranti Acciaio <i>Boring Antivibrations Steel Bars</i>	8 x dm_m 10 x dm_m	4 x dm_m^* 5 x dm_m^*	4 x dm_m^* 5 x dm_m^*
AFH...	Barre Alesatura Antivibranti Acciaio rinforzate con Metallo Duro <i>Boring Antivibrations Steel Bars with Hard Metal</i>	12 x dm_m 14 x dm_m	6 x dm_m 7 x dm_m	7 x dm_m

* Utilizzare Barre di Alesatura rinforzate con Metallo Duro / Use Boring Antivibrations Steel Bars with Hard Metal

COMBINAZIONI POSSIBILI DI BARRE E TESTINE / BARS AND HEADS POSSIBLE COMBINATIONS

CS20

	CS20-SCLCR/L-09	CS20-SDNCR/L-11	CS20-SDQCR/L-07	CS20-SDQCR/L-11	CS20-SDUCR/L-07	CS20-SDUCR/L-11	CS20-STUCR/L-11	CS20-STUCR/L-16	CS20-SDXCR/L-11	CS20-SVUCR/L-11	CS20-SIR/L-16	CS20-XXR/L		
Bar Diameter	Min Diameter (mm)													
Diam. 20	24	26	24	26	24	26	24	26	26	26	26	29		
Diam. 25	29	31	29	31	29	31	29	31	31	31	31	29		
Diam. 32	36	38	36	38	36	38	36	38	38	38	38	39		

CS40

	CS40-DCLNR/L-12	CS40-DDQNR/L-15	CS40-DDUNR/L-15	CS40-DTUNR/L-16	CS40-DTUNR/L-22	CS40-DWLN/L-08	CS40-SCLCR/L-12	CS40-SDQCR/L-11	CS40-SDUCR/L-11	CS40-STUCR/L-16	CS40-SVUCR/L-16	CS40-DIR/L-16	CS40-CIGR/L-...-11	CS40-XXR/L
Bar Diameter	Min Diameter (mm)													
Diam. 40	48	48	48	48	48	48	49	48	49	49	49	49	52,5	54
Diam. 50	58	58	58	58	58	58	59	58	59	59	59	59	62,5	54
Diam. 60	68	68	68	68	68	68	69	68	69	69	69	69	72,5	54

