

Easy Line

Comand Tool's annual promotions

CON **NUOVI PRODOTTI**

23
PROMO



finest metalworking solutions

MiniDABtool D10 - 6xD

BARRA + 10 INSERTI
BAR + 10 INSERTS

MiniBarre D10 con dispositivo Antivibrante / MiniBars D10 with Antivibration device

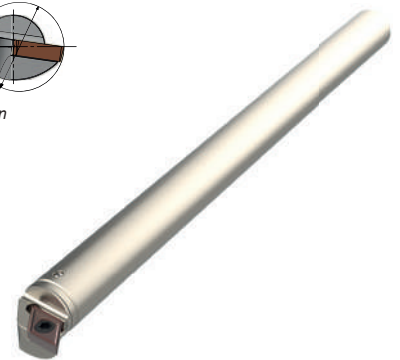
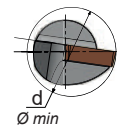
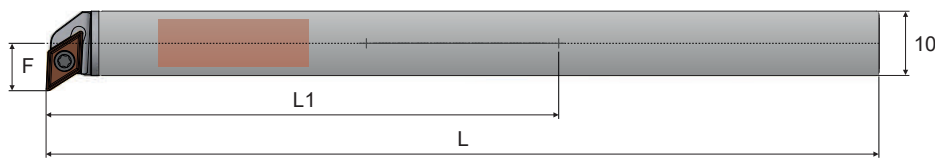

Inserti disponibili / Available inserts



95°

SCLCR/L06



93°

SDUCR/L07



93°

STUCR/L09

damper

Compra 1 MiniDABtool
Buy 1 MiniDABtool
10 INSERTI GRATIS
FREE INSERTS

NEW
PT8430
ricopertura inserto
insert coating

Composizione Set / Set Composition

Cod. PROMO	Barra / Bar	n° 10 Inserti / Inserts	L	L1	F	d min	Prezzo / Price
PRM13-0001	SFS10-06-SCLCR06	CCMT060204CSM PT8430	110	60	5,5	12	€ 199,00
PRM13-0002	SFS10-06-SDUCR07	DCMT070204CSM PT8430			8	14	€ 199,00
PRM13-0003	SFS10-06-STUCR09	TCMT090204CSF PT8430			6	12	€ 199,00
PRM13-0004	SFS10-06-SCLCL06	CCMT060204CSM PT8430			5,5	12	€ 199,00
PRM13-0005	SFS10-06-SDUCL07	DCMT070204CSM PT8430			8	14	€ 199,00
PRM13-0006	SFS10-06-STUCL09	TCMT090204CSF PT8430			6	12	€ 199,00

MiniDABtool D10 - 8xD

MiniBarre D10 con dispositivo Antivibrante + Metallo Duro / MiniBars D10 with Antivibration device + Carbide

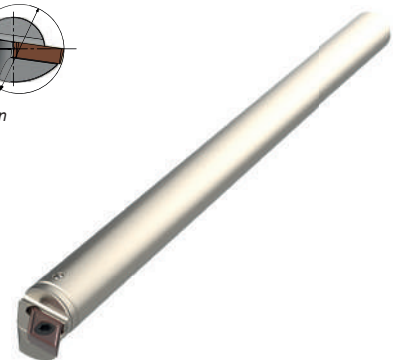
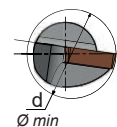
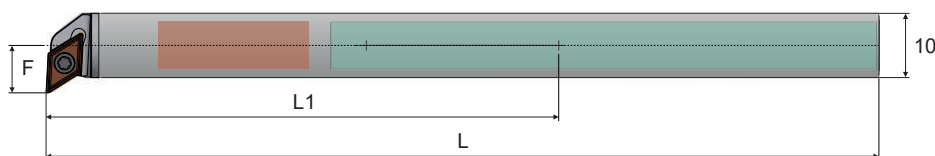

Inserti disponibili / Available inserts



95°

SCLCR/L06



93°

SDUCR/L07



93°

STUCR/L09

damper metallo duro / hard metal

Compra 1 MiniDABtool
Buy 1 MiniDABtool
10 INSERTI GRATIS
FREE INSERTS

NEW
PT8430
ricopertura inserto
insert coating

Composizione Set / Set Composition

Cod. PROMO	Barra / Bar	n° 10 Inserti / Inserts	L	L1	F	d min	Prezzo / Price
PRM13-0075	SFH10-08-SCLCR06	CCMT060204CSM PT8430	130	80	5,5	12	€ 329,00
PRM13-0076	SFH10-08-SDUCR07	DCMT070204CSM PT8430			8	14	€ 329,00
PRM13-0077	SFH10-08-STUCR09	TCMT090204CSF PT8430			6	12	€ 329,00
PRM13-0078	SFH10-08-SCLCL06	CCMT060204CSM PT8430			5,5	12	€ 329,00
PRM13-0079	SFH10-08-SDUCL07	DCMT070204CSM PT8430			8	14	€ 329,00
PRM13-0080	SFH10-08-STUCL09	TCMT090204CSF PT8430			6	12	€ 329,00

MiniDABtool[®] D10 - 10xD

BARRA + 10 INSERTI
BAR + 10 INSERTS

MiniBarre D10 con dispositivo Antivibrante + Metallo Duro / MiniBars D10 with Antivibration device + Carbide

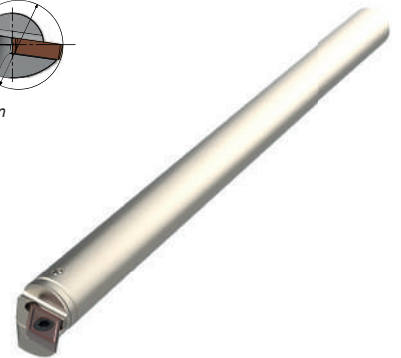
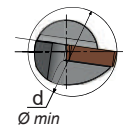
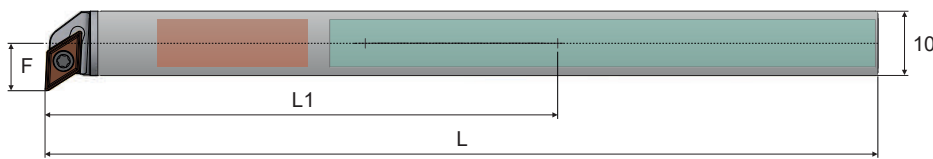

Inserti disponibili / Available inserts



95°



93°



93°

Compra 1 MiniDABtool
Buy 1 MiniDABtool
10 INSERTI GRATIS
FREE INSERTS

NEW
PT8430
ricopertura inserto
insert coating



Composizione Set / Set Composition

Cod. PROMO	Barra / Bar	n° 10 Inserti / Inserts	L	L1	F	d min	Prezzo / Price
PRM13-0007	SFH10-10-SCLCR06	CCMT060204CSM PT8430	150	100	5,5	12	€ 369,00
PRM13-0008	SFH10-10-SDUCR07	DCMT070204CSM PT8430			8	14	€ 369,00
PRM13-0009	SFH10-10-STUCR09	TCMT090204CSF PT8430			6	12	€ 369,00
PRM13-0010	SFH10-10-SCLCL06	CCMT060204CSM PT8430			5,5	12	€ 369,00
PRM13-0011	SFH10-10-SDUCL07	DCMT070204CSM PT8430			8	14	€ 369,00
PRM13-0012	SFH10-10-STUCL09	TCMT090204CSF PT8430			6	12	€ 369,00



Ottenete la massima efficienza dalle **MiniDABtool[®]** utilizzando con il **portabareno ModuTURN System**

vai a / go to pag.7

WALLCUT
adaptive contact technology

taglio di precarico per aumentare la rigidità del sistema di bloccaggio

1

Uscita Esterna EXT Liquido Refrigerante

2

Foro d'uscita Interna INT Liquido Refrigerante non presente su **MiniDABtool** D10 - D12

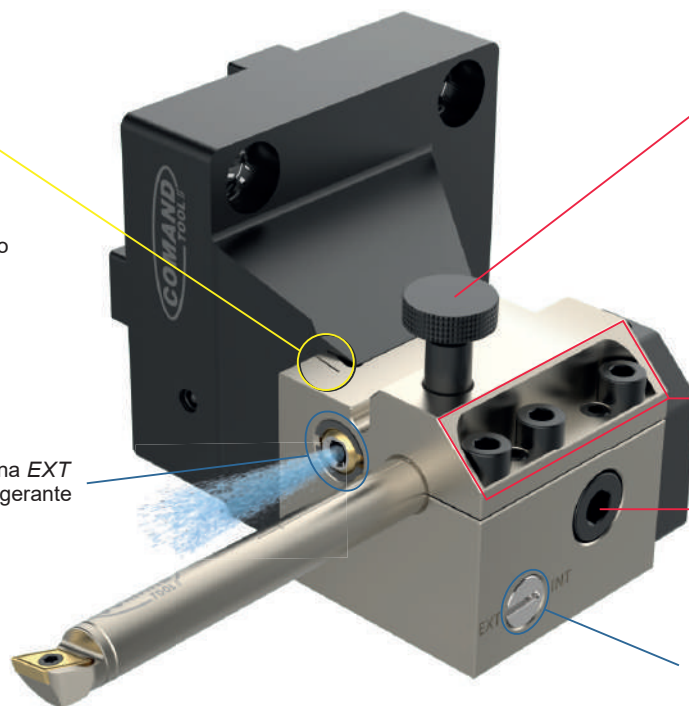

Vite di allineamento

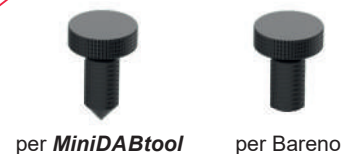

Viti bloccaggio Boreno

Vite fissaggio Base - Portabareno

Deviatore Liquido Refrigerante Esterno EXT 1 | Interno INT 2

AcquaStream
by COMAND TOOL

MiniDABtool[®] D12 - 6xD

BARRA + 10 INSERTI
BAR + 10 INSERTS

MiniBarre D12 con dispositivo Antivibrante / MiniBars D12 with Antivibration device

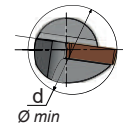
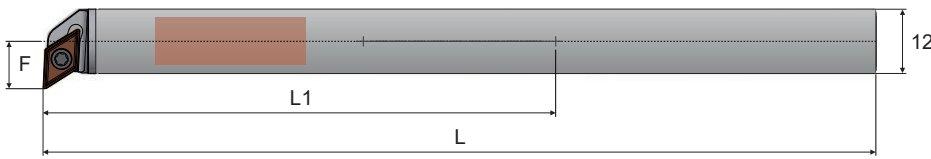

Inserti disponibili / Available inserts



95°



93°



93°

damper

Compra 1 MiniDABtool
Buy 1 MiniDABtool
10 INSERTI GRATIS
FREE INSERTS

NEW
PT8430
ricopertura inserto
insert coating

Composizione Set / Set Composition

Cod. PROMO	Barra / Bar	n° 10 Inserti / Inserts	L	L1	F	d min	Prezzo / Price
PRM13-0013	SFS12-06-SCLCR06	CCMT060204CSM PT8430	132	72	6,5	14	€ 219,00
PRM13-0014	SFS12-06-SDUCR07	DCMT070204CSM PT8430			9	16	€ 219,00
PRM13-0015	SFS12-06-STUCR09	TCMT090204CSF PT8430			8	15	€ 219,00
PRM13-0016	SFS12-06-SCLCL06	CCMT060204CSM PT8430			6,5	14	€ 219,00
PRM13-0017	SFS12-06-SDUCL07	DCMT070204CSM PT8430			9	16	€ 219,00
PRM13-0018	SFS12-06-STUCL09	TCMT090204CSF PT8430			8	15	€ 219,00

MiniDABtool[®] D12 - 8xD

MiniBarre D12 con dispositivo Antivibrante + Metallo Duro / MiniBars D12 with Antivibration device + Carbide

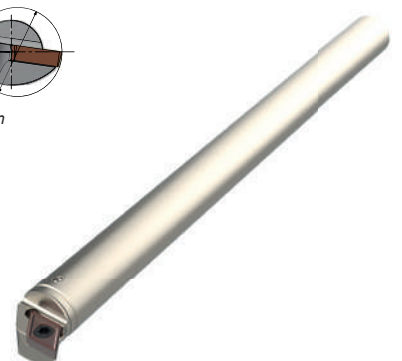
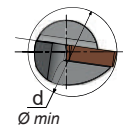
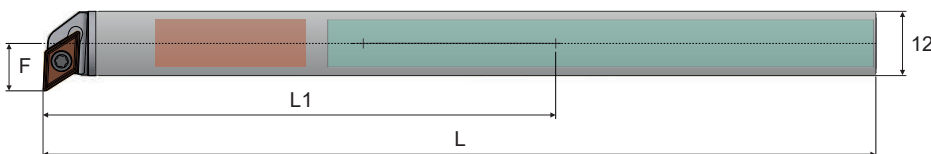

Inserti disponibili / Available inserts



95°



93°



93°

damper metallo duro / hard metal

Compra 1 MiniDABtool
Buy 1 MiniDABtool
10 INSERTI GRATIS
FREE INSERTS

NEW
PT8430
ricopertura inserto
insert coating

Composizione Set / Set Composition

Cod. PROMO	Barra / Bar	n° 10 Inserti / Inserts	L	L1	F	d min	Prezzo / Price
PRM13-0081	SFH12-08-SCLCR06	CCMT060204CSM PT8430	156	96	6,5	14	€ 369,00
PRM13-0082	SFH12-08-SDUCR07	DCMT070204CSM PT8430			9	16	€ 369,00
PRM13-0083	SFH12-08-STUCR09	TCMT090204CSF PT8430			8	15	€ 369,00
PRM13-0084	SFH12-08-SCLCL06	CCMT060204CSM PT8430			6,5	14	€ 369,00
PRM13-0085	SFH12-08-SDUCL07	DCMT070204CSM PT8430			9	16	€ 369,00
PRM13-0086	SFH12-08-STUCL09	TCMT090204CSF PT8430			8	15	€ 369,00

MiniDABtool[®] D12 - 10xD

BARRA + 10 INSERTI
BAR + 10 INSERTS

MiniBarre D12 con dispositivo Antivibrante / MiniBars D12 with Antivibration device

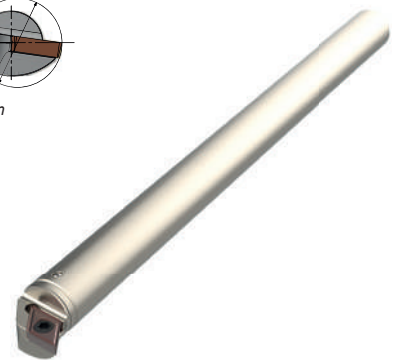
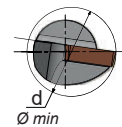
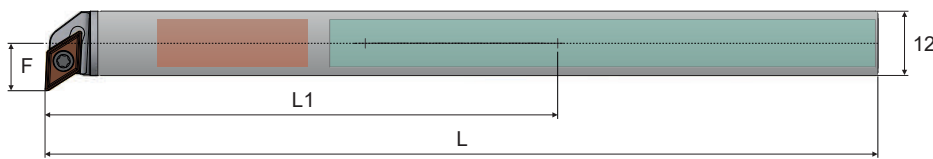

Inserti disponibili / Available inserts



95°



93°



93°



damper

metallo duro / hard metal

Compra 1 MiniDABtool
Buy 1 MiniDABtool
10 INSERTI GRATIS
FREE INSERTS

NEW

PT8430

ricopertura inserto
insert coating

Composizione Set / Set Composition

Cod. PROMO	Barra / Bar	n° 10 Inserti / Inserts	L	L1	F	d min	Prezzo / Price
PRM13-0019	SFH12-10-SCLCR06	CCMT060204CSM PT8430	180	120	6,5	14	€ 399,00
PRM13-0020	SFH12-10-SDUCR07	DCMT070204CSM PT8430			9	16	€ 399,00
PRM13-0021	SFH12-10-STUCR09	TCMT090204CSF PT8430			8	15	€ 399,00
PRM13-0022	SFH12-10-SCLCL06	CCMT060204CSM PT8430			6,5	14	€ 399,00
PRM13-0023	SFH12-10-SDUCL07	DCMT070204CSM PT8430			9	16	€ 399,00
PRM13-0024	SFH12-10-STUCL09	TCMT090204CSF PT8430			8	15	€ 399,00



Ottenete la massima efficienza dalle **MiniDABtool[®]** utilizzando con il **portabareno ModuTURN System**

vai a / go to pag.7

WALLCUT
adaptive contact technology

taglio di precarico per aumentare la rigidità del sistema di bloccaggio

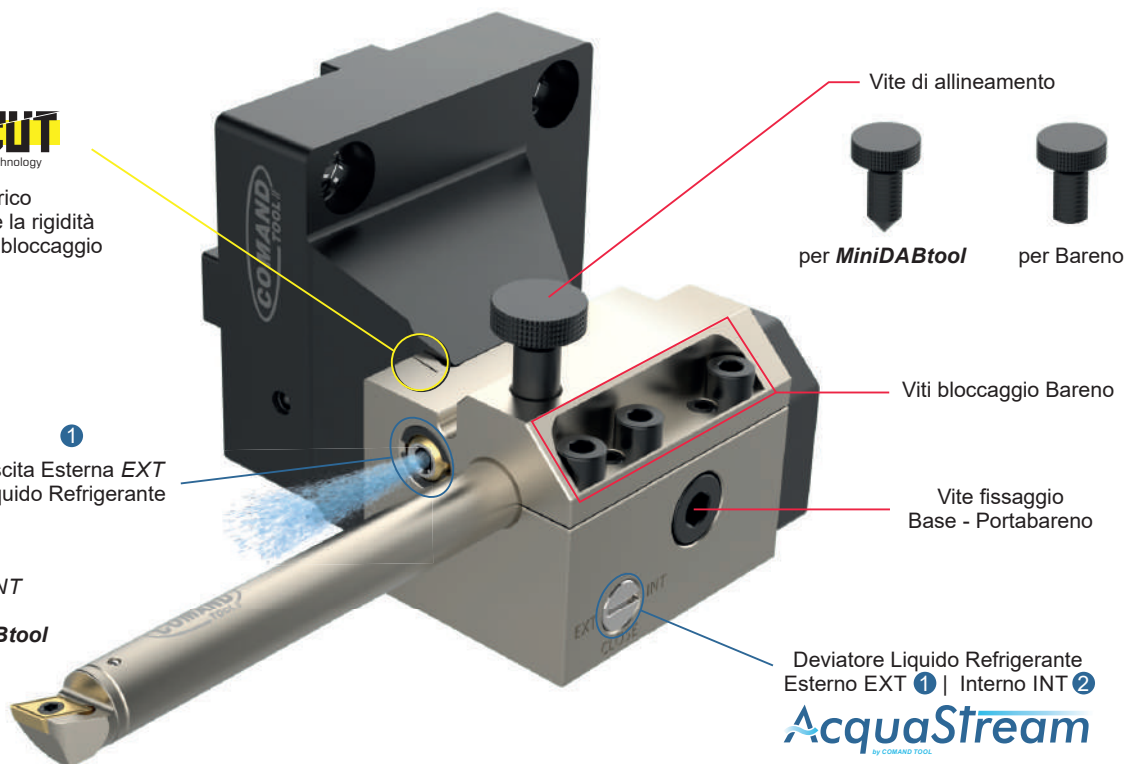

Deviatore Liquido Refrigerante Esterno EXT 1 | Interno INT 2
AcquaStream
by COMAND TOOL

MiniDABtool D16 - 6xD

BARRA + TESTINA
BAR + HEAD

MiniBarre D16 con dispositivo Antivibrante / MiniBars D16 with Antivibration device

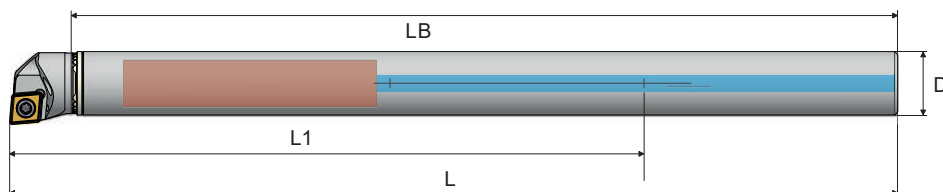

 damper 



BARRA + TESTINA
BAR + HEAD

Barra / Bar	D	L*	L1	LB
AFS16-06-140	16	160	96	140

* Lunghezza variabile in funzione della testina montata / Length may vary depending on head mounted

Composizione Set / Set Composition

Cod. PROMO	Barra / Bar	n° 1 Testina / Head	Prezzo / Price
PRM13-0175	AFS16-06-140	A vostra scelta / At your choice	€ 499,00



93°

CS16-SCLCR/L-06

LT	F	d min
20	11	20



93°

CS16-SDUCR/L-07

LT	F	d min
20	11	20



93°

CS16-STUCR/L-11

LT	F	d min
20	11	20



93°



CS16-SDXCR/L-07

LT	F	d min
26,6	13	22

MiniDABtool D16 - 8xD

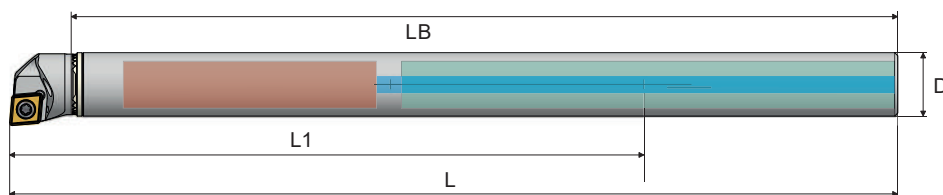
MiniBarre D16 con dispositivo Antivibrante + Metallo Duro / MiniBars D16 with Antivibration device + Carbide



 damper  metallo duro / hard metal 



BARRA + TESTINA
BAR + HEAD

Barra / Bar	D	L*	L1	LB
AFH16-08-172	16	192	128	172

* Lunghezza variabile in funzione della testina montata / Length may vary depending on head mounted

Composizione Set / Set Composition

Cod. PROMO	Barra / Bar	n° 1 Testina / Head	Prezzo / Price
PRM13-0176	AFH16-08-172	A vostra scelta / At your choice	€ 749,00



93°

CS16-SCLCR/L-06

LT	F	d min
20	11	20



93°

CS16-SDUCR/L-07

LT	F	d min
20	11	20



93°

CS16-STUCR/L-11

LT	F	d min
20	11	20

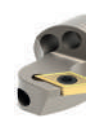

93°

CS16-SDXCR/L-07

LT	F	d min
26,6	13	22

MiniDABtool[®] D16 - 10xD

BARRA + TESTINA
BAR + HEAD

MiniBarre D16 con dispositivo Antivibrante / MiniBars D16 with Antivibration device

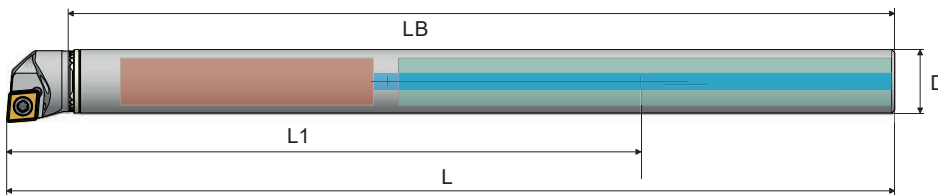

damper metallo duro / hard metal **AcquaStream**

Barra / Bar	D	L*	L1	LB
AFH16-10-204	16	224	160	204

* Lunghezza variabile in funzione della testina montata / Length may vary depending on head mounted

Composizione Set / Set Composition

Cod. PROMO	Barra / Bar	n° 1 Testina / Head	Prezzo / Price
PRM13-0177	AFH16-10-204	A vostra scelta / At your choice	€ 929,00

CS16-SCLCR/L-06				CS16-SDUCR/L-07				CS16-STUCR/L-11				CS16-SDXCR/L-07			
LT	F	d min		LT	F	d min		LT	F	d min		LT	F	d min	
20	11	20	93°	20	11	20	93°	20	11	20	93°	26,6	13	22	93°

Ottenete la massima efficienza dalle MiniDABtool[®] utilizzando con il portabareno ModuTURN System vai a / go to pag.7

WALLCUT
adaptive contact technology

taglio di precarico per aumentare la rigidità del sistema di bloccaggio

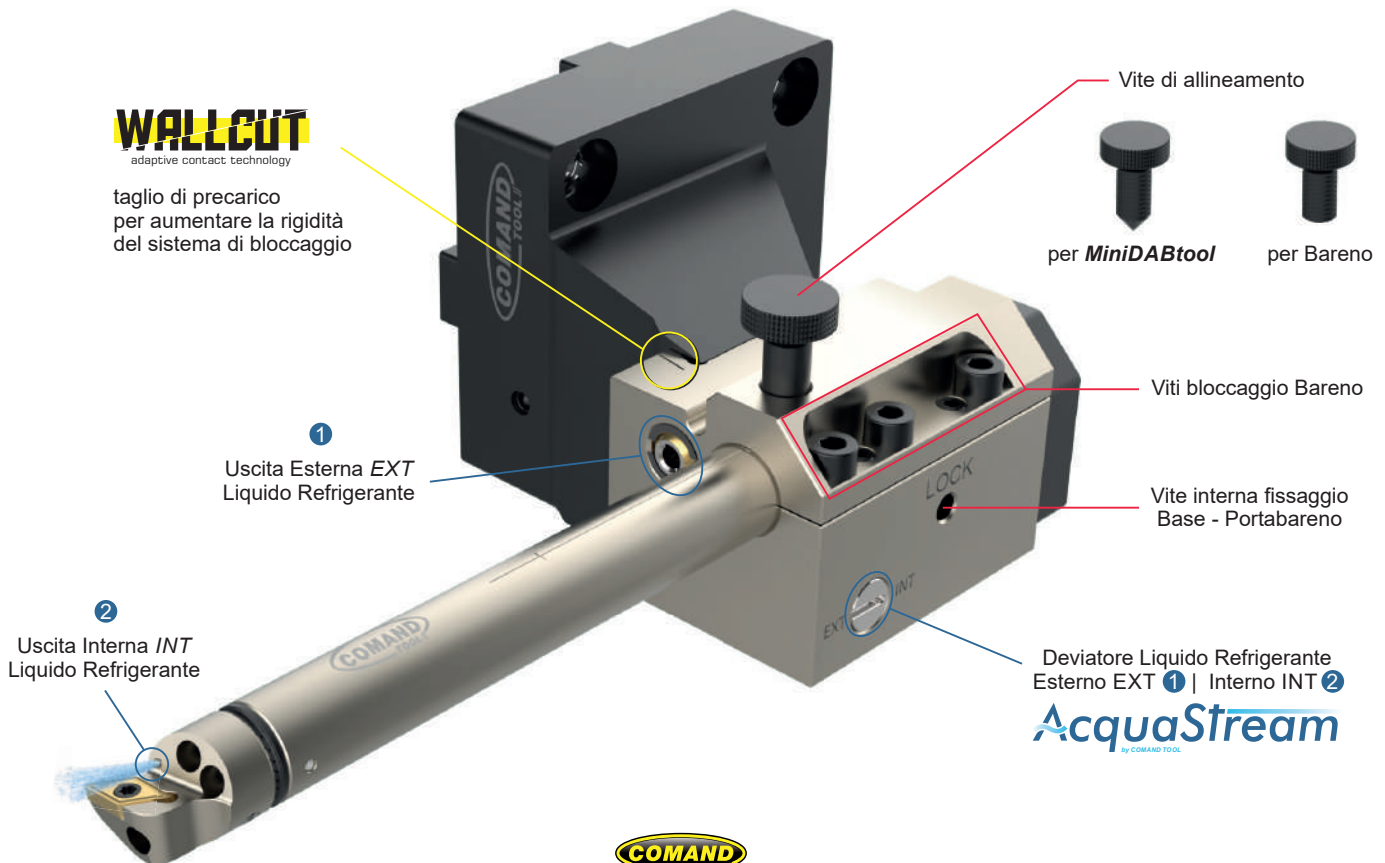

AcquaStream
by COMAND TOOL

Portabareno *ModuTURN System*

Tool holder for Modular Turning System

**BASE ASSIALE 90°
+
PORTABARENO**

**AXIAL BASE 90°
+
TOOL HOLDER**



Ideale per / Suitable for
MiniDABtool

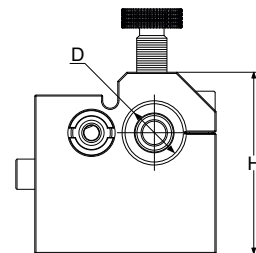
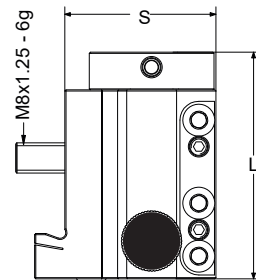

AcquaStream
by COMAND TOOL

Composizione Set / Set Composition

Cod. PROMO	n° 1 Base / Base 90° a tua scelta / of your choice	n° 1 Portabareno / Tool Holder a tua scelta / of your choice	Prezzo / Price
PRM12-0087	MTS-...-C1..C-B	MTS-E9D10-B	€ 249,00
PRM12-0088	MTS-...-C1..C-B	MTS-E9D12-B	€ 249,00
PRM12-0089	MTS-...-C1..C-B	MTS-E9D16-B	€ 249,00

Cod. PROMO	n° 1 Base / Base 90°	n° 3 Portabareni / Tool Holders	Prezzo / Price
PRM12-0134	MTS-...-C1..C-B	MTS-E9D10-12-16-B	€ 469,00

vedi lista sotto / see list below

Cod. PROMO	n° 1 Portabareno / Tool Holder	D	H	L	S	Prezzo / Price
PRM12-0090	MTS-E9D10-B	10	48	60	40	€ 139,00
PRM12-0091	MTS-E9D12-B	12	48	70	40	€ 139,00
PRM12-0092	MTS-E9D16-B	16	48	74	40	€ 139,00

Cod. PROMO	n° 3 Portabareni / Tool Holders	Prezzo / Price
PRM12-0093	n° 1 MTS-E9D10-B + n° 1 MTS-E9D12-B + n° 1 MTS-E9D16-B	€ 349,00

Basi Assiali 90° da accoppiare ai Portabareno MTS / Axial Base 90° to be coupled with Tool Holder MTS

BMT

MTS-BMT45-C1C4C-B
MTS-BMT55-C1C4C-B
MTS-BMT65-C1C4C-B
MTS-BMT75-C1C4C-B



DOOSAN STATIC S1

MTS-DS1M-C1C4C-B



DOOSAN STATIC S2

MTS-DS2M-C1C4C-B



BIGLIA

MTS-BG2L-C1C4C-B



VDI

MTS-VDI30-C1C-B
MTS-VDI40-C1C-B
MTS-VDI50-C1C-B



POLYGONAL "C"

MTS-C04-C1C-B
MTS-C05-C1C-B
MTS-C06-C1C-B



DABtool D20/25/32 - 6xD

BARRA + TESTINA
BAR + HEAD

Barre Antivibranti D20/25/32 + Testine CS20 / Antivibration Bars D20/25/32 + Heads CS20

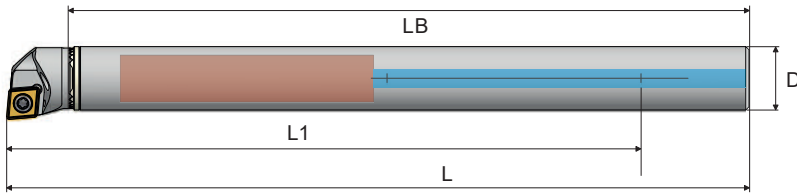

 damper **AcquaStream**



BARRA + TESTINA
BAR + HEAD

Barra / Bar	Boring Ratio	D	L*	L1	LB
AFS20-06-180	6 x D	20	200	120	180
AFS25-06-230		25	250	150	230
AFS32-06-300		32	320	192	300

* Lunghezza variabile in funzione della testina montata / Length may vary depending on head mounted

Composizione Set / Set Composition

Cod. PROMO	Barra / Bar	n° 1 Testina / Head	Prezzo / Price
PRM13-0178	AFS20-06-180	A vostra scelta / At your choice	€ 629,00
PRM13-0179	AFS25-06-230	A vostra scelta / At your choice	€ 669,00
PRM13-0180	AFS32-06-300	A vostra scelta / At your choice	€ 759,00



95°

CS20-SCLCR/L-09

LT	F	d min		
		AFS20	AFS25	AFS32
20,5	13	24	29	36



62,5°

CS20-SDNCR/L-11

LT	F	d min		
		AFS20	AFS25	AFS32
20,5	16	26	31	38



107,5°

CS20-SDQCR/L-07

LT	F	d min		
		AFS20	AFS25	AFS32
20,5	13	24	29	36



107,5°

CS20-SDQCR/L-11

LT	F	d min		
		AFS20	AFS25	AFS32
22,5	15	26	31	38



107,5°

CS20-SDUCR/L-07

LT	F	d min		
		AFS20	AFS25	AFS32
20,5	13	24	29	36



93°

CS20-SDUCR/L-11

LT	F	d min		
		AFS20	AFS25	AFS32
20,5	15	26	31	38



93°

CS20-STUCR/L-11

LT	F	d min		
		AFS20	AFS25	AFS32
20,5	13	24	29	36



93°

CS20-STUCR/L-16

LT	F	d min		
		AFS20	AFS25	AFS32
21	15	26	31	38



95°

CS20-SDXCR/L-11

LT	F	d min		
		AFS20	AFS25	AFS32
25	16	26	31	38



93°

CS20-SVUCR/L-11

LT	F	d min		
		AFS20	AFS25	AFS32
20,5	16	26	31	38



93°

CS20-SIR/L-16

LT	F	d min		
		AFS20	AFS25	AFS32
21,7	15	26	31	38

DABtool D20/25/32 - 8xD

BARRA + TESTINA
BAR + HEAD

Barre Antivibranti D20/25/32 + Testine CS20 / Antivibration Bars D20/25/32 + Heads CS20

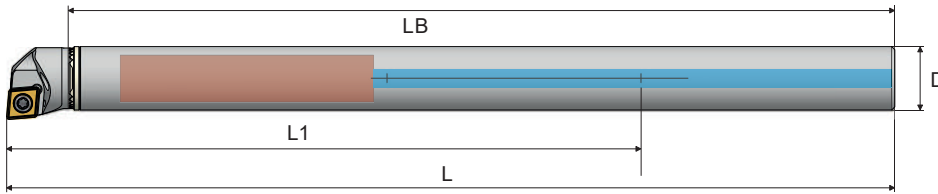

 damper **AcquaStream**



BARRA + TESTINA
BAR + HEAD

Barra / Bar	Boring Ratio	D	L*	L1	LB
AFS20-08-220	8 x D	20	240	160	220
AFS25-08-280		25	300	200	280
AFS32-08-364		32	384	256	364

* Lunghezza variabile in funzione della testina montata / Length may vary depending on head mounted

Composizione Set / Set Composition

Cod. PROMO	Barra / Bar	n° 1 Testina / Head	Prezzo / Price
PRM13-0181	AFS20-08-220	A vostra scelta / At your choice	€ 699,00
PRM13-0182	AFS25-08-280	A vostra scelta / At your choice	€ 729,00
PRM13-0183	AFS32-08-364	A vostra scelta / At your choice	€ 799,00



95°

CS20-SCLCR/L-09

LT	F	d min		
		AFS20	AFS25	AFS32
20,5	13	24	29	36



62,5°

CS20-SDNCR/L-11

LT	F	d min		
		AFS20	AFS25	AFS32
20,5	16	26	31	38



107,5°

CS20-SDQCR/L-07

LT	F	d min		
		AFS20	AFS25	AFS32
20,5	13	24	29	36



107,5°

CS20-SDQCR/L-11

LT	F	d min		
		AFS20	AFS25	AFS32
22,5	15	26	31	38



107,5°

CS20-SDUCR/L-07

LT	F	d min		
		AFS20	AFS25	AFS32
20,5	13	24	29	36



93°

CS20-SDUCR/L-11

LT	F	d min		
		AFS20	AFS25	AFS32
20,5	15	26	31	38



93°

CS20-STUCR/L-11

LT	F	d min		
		AFS20	AFS25	AFS32
20,5	13	24	29	36



93°

CS20-STUCR/L-16

LT	F	d min		
		AFS20	AFS25	AFS32
21	15	26	31	38



95°

CS20-SDXCR/L-11

LT	F	d min		
		AFS20	AFS25	AFS32
25	16	26	31	38



93°

CS20-SVUCR/L-11

LT	F	d min		
		AFS20	AFS25	AFS32
20,5	16	26	31	38



93°

CS20-SIR/L-16

LT	F	d min		
		AFS20	AFS25	AFS32
21,7	15	26	31	38

DABtool D20/25/32 - 10xD

BARRA + TESTINA
BAR + HEAD

Barre Antivibranti D20/25/32 + Testine CS20 / Antivibration Bars D20/25/32 + Heads CS20

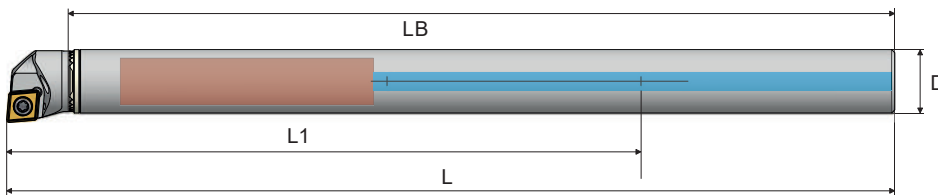

damper **AcquaStream**

Barra / Bar	Boring Ratio	D	L*	L1	LB
AFS20-10-260	10 x D	20	280	200	260
AFS25-10-330		25	350	250	330
AFS32-10-428		32	448	320	428

* Lunghezza variabile in funzione della testina montata / Length may vary depending on head mounted

Composizione Set / Set Composition

Cod. PROMO	Barra / Bar	n° 1 Testina / Head	Prezzo / Price
PRM13-0184	AFS20-10-260	A vostra scelta / At your choice	€ 1199,00
PRM13-0185	AFS25-10-330	A vostra scelta / At your choice	€ 1299,00
PRM13-0186	AFS32-10-428	A vostra scelta / At your choice	€ 1399,00



95°

CS20-SCLCR/L-09					
LT	F	d min			
20,5	13	AFS20	AFS25	AFS32	
		24	29	36	



62,5°

CS20-SDNCR/L-11					
LT	F	d min			
20,5	16	AFS20	AFS25	AFS32	
		26	31	38	



107,5°

CS20-SDQCR/L-07					
LT	F	d min			
20,5	13	AFS20	AFS25	AFS32	
		24	29	36	



107,5°

CS20-SDQCR/L-11					
LT	F	d min			
22,5	15	AFS20	AFS25	AFS32	
		26	31	38	



107,5°

CS20-SDUCR/L-07					
LT	F	d min			
20,5	13	AFS20	AFS25	AFS32	
		24	29	36	



93°

CS20-SDUCR/L-11					
LT	F	d min			
20,5	15	AFS20	AFS25	AFS32	
		26	31	38	



93°

CS20-STUCR/L-11					
LT	F	d min			
20,5	13	AFS20	AFS25	AFS32	
		24	29	36	



93°

CS20-STUCR/L-16					
LT	F	d min			
21	15	AFS20	AFS25	AFS32	
		26	31	38	



95°

CS20-SDXCR/L-11					
LT	F	d min			
25	16	AFS20	AFS25	AFS32	
		26	31	38	



93°

CS20-SVUCR/L-11					
LT	F	d min			
20,5	16	AFS20	AFS25	AFS32	
		26	31	38	



93°

CS20-SIR/L-16					
LT	F	d min			
21,7	15	AFS20	AFS25	AFS32	
		26	31	38	

DABtool D40/50/60 - 6xD

BARRA + TESTINA
BAR + HEAD

Barre Antivibranti D40/50/60 + Testine CS40 / Antivibration Bars D40/50/60 + Heads CS40

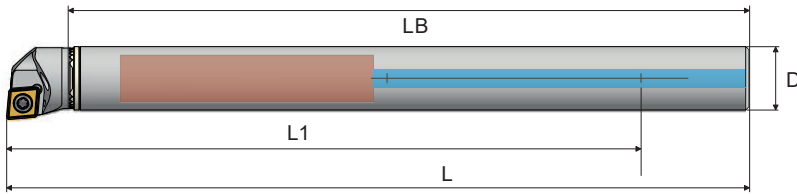

damper **AcquaStream**



BARRA + TESTINA
BAR + HEAD

Barra / Bar	Boring Ratio	D	L*	L1	LB
AFS40-06-368	6 x D	40	400	240	368
AFS50-06-468		50	500	300	468
AFS60-06-568		60	600	360	568

* Lunghezza variabile in funzione della testina montata / Length may vary depending on head mounted

Cod. PROMO	Composizione Set / Set Composition		Prezzo / Price
	Barra / Bar	n° 1 Testina / Head	
PRM13-0187	AFS40-06-368	A vostra scelta / At your choice	€ 849,00
PRM13-0188	AFS50-06-468	A vostra scelta / At your choice	€ 999,00
PRM13-0189	AFS60-06-568	A vostra scelta / At your choice	€ 1299,00

 95° CS40-DCLNR/L-12/16 <table border="1"> <tr><th>LT</th><th>F</th><th colspan="3">d min</th></tr> <tr><td>35</td><td>27</td><td>AFS40</td><td>AFS50</td><td>AFS60</td></tr> <tr><td></td><td></td><td>48</td><td>58</td><td>68</td></tr> </table>	LT	F	d min			35	27	AFS40	AFS50	AFS60			48	58	68	 107,5° CS40-DDQNR/L-15 <table border="1"> <tr><th>LT</th><th>F</th><th colspan="3">d min</th></tr> <tr><td>35</td><td>27</td><td>AFS40</td><td>AFS50</td><td>AFS60</td></tr> <tr><td></td><td></td><td>48</td><td>58</td><td>68</td></tr> </table>	LT	F	d min			35	27	AFS40	AFS50	AFS60			48	58	68	 93° CS40-DDUNR/L-15 <table border="1"> <tr><th>LT</th><th>F</th><th colspan="3">d min</th></tr> <tr><td>35</td><td>27</td><td>AFS40</td><td>AFS50</td><td>AFS60</td></tr> <tr><td></td><td></td><td>48</td><td>58</td><td>68</td></tr> </table>	LT	F	d min			35	27	AFS40	AFS50	AFS60			48	58	68	 93° CS40-DTUNR/L-16/22 <table border="1"> <tr><th>LT</th><th>F</th><th colspan="3">d min</th></tr> <tr><td>16</td><td>22</td><td>AFS40</td><td>AFS50</td><td>AFS60</td></tr> <tr><td>35</td><td>40</td><td>48</td><td>58</td><td>68</td></tr> </table>	LT	F	d min			16	22	AFS40	AFS50	AFS60	35	40	48	58	68	 93° CS40-DVUNR/L-16 <table border="1"> <tr><th>LT</th><th>F</th><th colspan="3">d min</th></tr> <tr><td>35</td><td>29</td><td>AFS40</td><td>AFS50</td><td>AFS60</td></tr> <tr><td></td><td></td><td>50</td><td>60</td><td>70</td></tr> </table>	LT	F	d min			35	29	AFS40	AFS50	AFS60			50	60	70
LT	F	d min																																																																													
35	27	AFS40	AFS50	AFS60																																																																											
		48	58	68																																																																											
LT	F	d min																																																																													
35	27	AFS40	AFS50	AFS60																																																																											
		48	58	68																																																																											
LT	F	d min																																																																													
35	27	AFS40	AFS50	AFS60																																																																											
		48	58	68																																																																											
LT	F	d min																																																																													
16	22	AFS40	AFS50	AFS60																																																																											
35	40	48	58	68																																																																											
LT	F	d min																																																																													
35	29	AFS40	AFS50	AFS60																																																																											
		50	60	70																																																																											
 95° CS40-DWLNLR/L-08 <table border="1"> <tr><th>LT</th><th>F</th><th colspan="3">d min</th></tr> <tr><td>35</td><td>27</td><td>AFS40</td><td>AFS50</td><td>AFS60</td></tr> <tr><td></td><td></td><td>48</td><td>58</td><td>68</td></tr> </table>	LT	F	d min			35	27	AFS40	AFS50	AFS60			48	58	68	 95° CS40-SCLCR/L-12 <table border="1"> <tr><th>LT</th><th>F</th><th colspan="3">d min</th></tr> <tr><td>32</td><td>27</td><td>AFS40</td><td>AFS50</td><td>AFS60</td></tr> <tr><td></td><td></td><td>49</td><td>59</td><td>69</td></tr> </table>	LT	F	d min			32	27	AFS40	AFS50	AFS60			49	59	69	 107,5° CS40-SDQCR/L-11 <table border="1"> <tr><th>LT</th><th>F</th><th colspan="3">d min</th></tr> <tr><td>32</td><td>27</td><td>AFS40</td><td>AFS50</td><td>AFS60</td></tr> <tr><td></td><td></td><td>48</td><td>58</td><td>68</td></tr> </table>	LT	F	d min			32	27	AFS40	AFS50	AFS60			48	58	68	 93° CS40-SDUCR/L-11/15 <table border="1"> <tr><th>LT</th><th>F</th><th colspan="3">d min</th></tr> <tr><td>32</td><td>27</td><td>AFS40</td><td>AFS50</td><td>AFS60</td></tr> <tr><td></td><td></td><td>49</td><td>59</td><td>69</td></tr> </table>	LT	F	d min			32	27	AFS40	AFS50	AFS60			49	59	69	 93° CS40-STUCR/L-16 <table border="1"> <tr><th>LT</th><th>F</th><th colspan="3">d min</th></tr> <tr><td>32</td><td>27</td><td>AFS40</td><td>AFS50</td><td>AFS60</td></tr> <tr><td></td><td></td><td>49</td><td>59</td><td>69</td></tr> </table>	LT	F	d min			32	27	AFS40	AFS50	AFS60			49	59	69
LT	F	d min																																																																													
35	27	AFS40	AFS50	AFS60																																																																											
		48	58	68																																																																											
LT	F	d min																																																																													
32	27	AFS40	AFS50	AFS60																																																																											
		49	59	69																																																																											
LT	F	d min																																																																													
32	27	AFS40	AFS50	AFS60																																																																											
		48	58	68																																																																											
LT	F	d min																																																																													
32	27	AFS40	AFS50	AFS60																																																																											
		49	59	69																																																																											
LT	F	d min																																																																													
32	27	AFS40	AFS50	AFS60																																																																											
		49	59	69																																																																											
 93° CS40-SVUBR/L-16 <table border="1"> <tr><th>LT</th><th>F</th><th colspan="3">d min</th></tr> <tr><td>32</td><td>27</td><td>AFS40</td><td>AFS50</td><td>AFS60</td></tr> <tr><td></td><td></td><td>49</td><td>59</td><td>69</td></tr> </table>	LT	F	d min			32	27	AFS40	AFS50	AFS60			49	59	69	 93° CS40-SVUCR/L-11/16 <table border="1"> <tr><th>LT</th><th>F</th><th colspan="3">d min</th></tr> <tr><td>32</td><td>27</td><td>AFS40</td><td>AFS50</td><td>AFS60</td></tr> <tr><td></td><td></td><td>49</td><td>59</td><td>69</td></tr> </table>	LT	F	d min			32	27	AFS40	AFS50	AFS60			49	59	69	 90° CS40-DIR/L-16/22 <table border="1"> <tr><th>LT</th><th>F</th><th colspan="3">d min</th></tr> <tr><td>16</td><td>22</td><td>AFS40</td><td>AFS50</td><td>AFS60</td></tr> <tr><td>35</td><td>40</td><td>49</td><td>59</td><td>69</td></tr> </table>	LT	F	d min			16	22	AFS40	AFS50	AFS60	35	40	49	59	69	 90° CS40-CIGR/L-20/30/40/50-11 <table border="1"> <tr><th>LT</th><th>F</th><th colspan="3">d min</th></tr> <tr><td>25</td><td>32</td><td>AFS40</td><td>AFS50</td><td>AFS60</td></tr> <tr><td></td><td></td><td>52,5</td><td>62,5</td><td>72,5</td></tr> </table>	LT	F	d min			25	32	AFS40	AFS50	AFS60			52,5	62,5	72,5	 90° CS40-PU10R/L <table border="1"> <tr><th>LT</th><th colspan="3">d min</th></tr> <tr><td>32</td><td>AFS40</td><td>AFS50</td><td>AFS60</td></tr> <tr><td></td><td>-</td><td>-</td><td>-</td></tr> </table>	LT	d min			32	AFS40	AFS50	AFS60		-	-	-			
LT	F	d min																																																																													
32	27	AFS40	AFS50	AFS60																																																																											
		49	59	69																																																																											
LT	F	d min																																																																													
32	27	AFS40	AFS50	AFS60																																																																											
		49	59	69																																																																											
LT	F	d min																																																																													
16	22	AFS40	AFS50	AFS60																																																																											
35	40	49	59	69																																																																											
LT	F	d min																																																																													
25	32	AFS40	AFS50	AFS60																																																																											
		52,5	62,5	72,5																																																																											
LT	d min																																																																														
32	AFS40	AFS50	AFS60																																																																												
	-	-	-																																																																												

DABtool D40/50/60 - 8xD

BARRA + TESTINA
BAR + HEAD

Barre Antivibranti D40/50/60 + Testine CS40 / Antivibration Bars D40/50/60 + Heads CS40

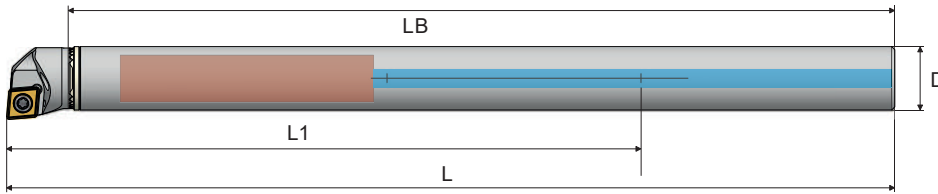

damper **AcquaStream**



Barra / Bar	Boring Ratio	D	L*	L1	LB
AFS40-08-448	8 x D	40	480	320	448
AFS50-08-568		50	600	400	568
AFS60-08-688		60	720	480	688

* Lunghezza variabile in funzione della testina montata / Length may vary depending on head mounted

Cod. PROMO	Composizione Set / Set Composition		Prezzo / Price
	Barra / Bar	n° 1 Testina / Head	
PRM13-0190	AFS40-08-448	A vostra scelta / At your choice	€ 949,00
PRM13-0191	AFS50-08-568	A vostra scelta / At your choice	€ 1099,00
PRM13-0192	AFS60-08-688	A vostra scelta / At your choice	€ 1399,00

 95° CS40-DCLNR/L-12/16 <table border="1"> <tr><th>LT</th><th>F</th><th colspan="3">d min</th></tr> <tr><td>35</td><td>27</td><td>AFS40</td><td>AFS50</td><td>AFS60</td></tr> <tr><td></td><td></td><td>48</td><td>58</td><td>68</td></tr> </table>	LT	F	d min			35	27	AFS40	AFS50	AFS60			48	58	68	 107,5° CS40-DDQNR/L-15 <table border="1"> <tr><th>LT</th><th>F</th><th colspan="3">d min</th></tr> <tr><td>35</td><td>27</td><td>AFS40</td><td>AFS50</td><td>AFS60</td></tr> <tr><td></td><td></td><td>48</td><td>58</td><td>68</td></tr> </table>	LT	F	d min			35	27	AFS40	AFS50	AFS60			48	58	68	 93° CS40-DDUNR/L-15 <table border="1"> <tr><th>LT</th><th>F</th><th colspan="3">d min</th></tr> <tr><td>35</td><td>27</td><td>AFS40</td><td>AFS50</td><td>AFS60</td></tr> <tr><td></td><td></td><td>48</td><td>58</td><td>68</td></tr> </table>	LT	F	d min			35	27	AFS40	AFS50	AFS60			48	58	68	 93° CS40-DTUNR/L-16/22 <table border="1"> <tr><th>LT</th><th>F</th><th colspan="3">d min</th></tr> <tr><td>16</td><td>22</td><td>AFS40</td><td>AFS50</td><td>AFS60</td></tr> <tr><td>35</td><td>40</td><td>48</td><td>58</td><td>68</td></tr> </table>	LT	F	d min			16	22	AFS40	AFS50	AFS60	35	40	48	58	68	 93° CS40-DVUNR/L-16 <table border="1"> <tr><th>LT</th><th>F</th><th colspan="3">d min</th></tr> <tr><td>35</td><td>29</td><td>AFS40</td><td>AFS50</td><td>AFS60</td></tr> <tr><td></td><td></td><td>50</td><td>60</td><td>70</td></tr> </table>	LT	F	d min			35	29	AFS40	AFS50	AFS60			50	60	70
LT	F	d min																																																																													
35	27	AFS40	AFS50	AFS60																																																																											
		48	58	68																																																																											
LT	F	d min																																																																													
35	27	AFS40	AFS50	AFS60																																																																											
		48	58	68																																																																											
LT	F	d min																																																																													
35	27	AFS40	AFS50	AFS60																																																																											
		48	58	68																																																																											
LT	F	d min																																																																													
16	22	AFS40	AFS50	AFS60																																																																											
35	40	48	58	68																																																																											
LT	F	d min																																																																													
35	29	AFS40	AFS50	AFS60																																																																											
		50	60	70																																																																											
 95° CS40-DWLNLR/L-08 <table border="1"> <tr><th>LT</th><th>F</th><th colspan="3">d min</th></tr> <tr><td>35</td><td>27</td><td>AFS40</td><td>AFS50</td><td>AFS60</td></tr> <tr><td></td><td></td><td>48</td><td>58</td><td>68</td></tr> </table>	LT	F	d min			35	27	AFS40	AFS50	AFS60			48	58	68	 95° CS40-SCLCR/L-12 <table border="1"> <tr><th>LT</th><th>F</th><th colspan="3">d min</th></tr> <tr><td>32</td><td>27</td><td>AFS40</td><td>AFS50</td><td>AFS60</td></tr> <tr><td></td><td></td><td>49</td><td>59</td><td>69</td></tr> </table>	LT	F	d min			32	27	AFS40	AFS50	AFS60			49	59	69	 107,5° CS40-SDQCR/L-11 <table border="1"> <tr><th>LT</th><th>F</th><th colspan="3">d min</th></tr> <tr><td>32</td><td>27</td><td>AFS40</td><td>AFS50</td><td>AFS60</td></tr> <tr><td></td><td></td><td>48</td><td>58</td><td>68</td></tr> </table>	LT	F	d min			32	27	AFS40	AFS50	AFS60			48	58	68	 93° CS40-SDUCR/L-11/15 <table border="1"> <tr><th>LT</th><th>F</th><th colspan="3">d min</th></tr> <tr><td>32</td><td>27</td><td>AFS40</td><td>AFS50</td><td>AFS60</td></tr> <tr><td></td><td></td><td>49</td><td>59</td><td>69</td></tr> </table>	LT	F	d min			32	27	AFS40	AFS50	AFS60			49	59	69	 93° CS40-STUCR/L-16 <table border="1"> <tr><th>LT</th><th>F</th><th colspan="3">d min</th></tr> <tr><td>32</td><td>27</td><td>AFS40</td><td>AFS50</td><td>AFS60</td></tr> <tr><td></td><td></td><td>49</td><td>59</td><td>69</td></tr> </table>	LT	F	d min			32	27	AFS40	AFS50	AFS60			49	59	69
LT	F	d min																																																																													
35	27	AFS40	AFS50	AFS60																																																																											
		48	58	68																																																																											
LT	F	d min																																																																													
32	27	AFS40	AFS50	AFS60																																																																											
		49	59	69																																																																											
LT	F	d min																																																																													
32	27	AFS40	AFS50	AFS60																																																																											
		48	58	68																																																																											
LT	F	d min																																																																													
32	27	AFS40	AFS50	AFS60																																																																											
		49	59	69																																																																											
LT	F	d min																																																																													
32	27	AFS40	AFS50	AFS60																																																																											
		49	59	69																																																																											
 93° CS40-SVUBR/L-16 <table border="1"> <tr><th>LT</th><th>F</th><th colspan="3">d min</th></tr> <tr><td>32</td><td>27</td><td>AFS40</td><td>AFS50</td><td>AFS60</td></tr> <tr><td></td><td></td><td>49</td><td>59</td><td>69</td></tr> </table>	LT	F	d min			32	27	AFS40	AFS50	AFS60			49	59	69	 93° CS40-SVUCR/L-11/16 <table border="1"> <tr><th>LT</th><th>F</th><th colspan="3">d min</th></tr> <tr><td>32</td><td>27</td><td>AFS40</td><td>AFS50</td><td>AFS60</td></tr> <tr><td></td><td></td><td>49</td><td>59</td><td>69</td></tr> </table>	LT	F	d min			32	27	AFS40	AFS50	AFS60			49	59	69	 90° CS40-DIR/L-16/22 <table border="1"> <tr><th>LT</th><th>F</th><th colspan="3">d min</th></tr> <tr><td>16</td><td>22</td><td>AFS40</td><td>AFS50</td><td>AFS60</td></tr> <tr><td>35</td><td>40</td><td>49</td><td>59</td><td>69</td></tr> </table>	LT	F	d min			16	22	AFS40	AFS50	AFS60	35	40	49	59	69	 90° CS40-CIGR/L-20/30/40/50-11 <table border="1"> <tr><th>LT</th><th>F</th><th colspan="3">d min</th></tr> <tr><td>25</td><td>32</td><td>AFS40</td><td>AFS50</td><td>AFS60</td></tr> <tr><td></td><td></td><td>52,5</td><td>62,5</td><td>72,5</td></tr> </table>	LT	F	d min			25	32	AFS40	AFS50	AFS60			52,5	62,5	72,5	 90° CS40-PU10R/L <table border="1"> <tr><th>LT</th><th colspan="3">d min</th></tr> <tr><td>32</td><td>AFS40</td><td>AFS50</td><td>AFS60</td></tr> <tr><td></td><td>-</td><td>-</td><td>-</td></tr> </table>	LT	d min			32	AFS40	AFS50	AFS60		-	-	-			
LT	F	d min																																																																													
32	27	AFS40	AFS50	AFS60																																																																											
		49	59	69																																																																											
LT	F	d min																																																																													
32	27	AFS40	AFS50	AFS60																																																																											
		49	59	69																																																																											
LT	F	d min																																																																													
16	22	AFS40	AFS50	AFS60																																																																											
35	40	49	59	69																																																																											
LT	F	d min																																																																													
25	32	AFS40	AFS50	AFS60																																																																											
		52,5	62,5	72,5																																																																											
LT	d min																																																																														
32	AFS40	AFS50	AFS60																																																																												
	-	-	-																																																																												

DABtool D40/50/60 - 10xD

BARRA + TESTINA
BAR + HEAD

Barre Antivibranti D40/50/60 + Testine CS40 / Antivibration Bars D40/50/60 + Heads CS40

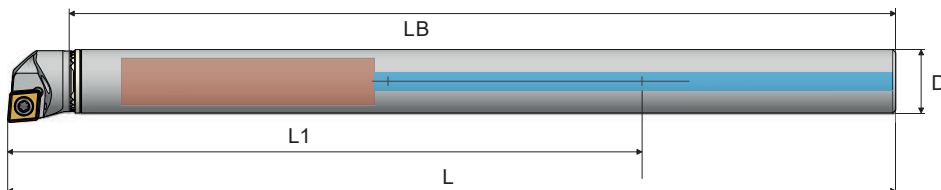

damper

AcquaStream



BARRA + TESTINA
BAR + HEAD

Barra / Bar	Boring Ratio	D	L*	L1	LB
AFS40-10-528	10 x D	40	560	400	528
AFS50-10-668		50	700	500	668
AFS60-10-808		60	840	600	808

* Lunghezza variabile in funzione della testina montata / Length may vary depending on head mounted

Composizione Set / Set Composition

Cod. PROMO	Barra / Bar	n° 1 Testina / Head	Prezzo / Price
PRM13-0193	AFS40-10-528	A vostra scelta / At your choice	€ 1269,00
PRM13-0194	AFS50-10-668	A vostra scelta / At your choice	€ 1999,00
PRM13-0195	AFS60-10-808	A vostra scelta / At your choice	€ 2599,00



95°

CS40-DCLNR/L-12/16		d min		
LT	F	AFS40	AFS50	AFS60
35	27	48	58	68



107,5°

CS40-DDQNR/L-15		d min		
LT	F	AFS40	AFS50	AFS60
35	27	48	58	68



93°

CS40-DDUNR/L-15		d min		
LT	F	AFS40	AFS50	AFS60
35	27	48	58	68



93°

CS40-DTUNR/L-16/22		d min		
LT	F	AFS40	AFS50	AFS60
16	22	48	58	68



93°

CS40-DVUNR/L-16		d min		
LT	F	AFS40	AFS50	AFS60
35	29	50	60	70



95°

CS40-DWLNLR/L-08		d min		
LT	F	AFS40	AFS50	AFS60
35	27	48	58	68



95°

CS40-SCLCR/L-12		d min		
LT	F	AFS40	AFS50	AFS60
32	27	49	59	69



107,5°

CS40-SDQCR/L-11		d min		
LT	F	AFS40	AFS50	AFS60
32	27	48	58	68



93°

CS40-SDUCR/L-11/15		d min		
LT	F	AFS40	AFS50	AFS60
32	27	49	59	69



93°

CS40-STUCR/L-16		d min		
LT	F	AFS40	AFS50	AFS60
32	27	49	59	69



93°

CS40-SVUBR/L-16		d min		
LT	F	AFS40	AFS50	AFS60
32	27	49	59	69



93°

CS40-SVUCR/L-11/16		d min		
LT	F	AFS40	AFS50	AFS60
32	27	49	59	69



90°

CS40-DIR/L-16/22		d min		
LT	F	AFS40	AFS50	AFS60
16	22	49	59	69



90°

CS40-CIGR/L-20/30/40/50-11		d min		
LT	F	AFS40	AFS50	AFS60
25	32	52,5	62,5	72,5



Troncatura
Grooving

Portautensile
Toolholder

CS40-PU10R/L		d min		
LT	F	AFS40	AFS50	AFS60
32	-	-	-	-

Sistema di Tornitura e Troncatura Modulare / Turning and Parting-Off Modular System

BMT



B1B4C-A



B2B3C-B

BMT DOPPIO



D1D2C

BMT (DMG-MORI)



B1B4C-A



B2B3C-B

BIGLIA 2S



B1B4C-A



B2B3C-B

BIGLIA 2L



B1B4C-A



B2B3C-B

NEW

BIGLIA 3S



B1B4C-A



B2B3C-B

NEW

BIGLIA 3L



B1B4C-A



B2B3C-B

PROMO

3
PZ / PCS

Ordine minimo
Minimum order

**BASI A SCELTA
BASE OF YOUR CHOICE**

PROMO

5
PZ / PCS

Ordine minimo
Minimum order

Cod. PROMO	PREZZO / PRICE Singola Base / Single Base	BMT	Cod. PROMO	PREZZO / PRICE Singola Base / Single Base
PRM12-0001	€ 159,00	MTS-BMT45-B1B4C-A	PRM12-0023	€ 139,00
PRM12-0002	€ 169,00	MTS-BMT55-B1B4C-A	PRM12-0024	€ 149,00
PRM12-0003	€ 179,00	MTS-BMT65-B1B4C-A	PRM12-0025	€ 159,00
PRM12-0004	€ 199,00	MTS-BMT75-B1B4C-A	PRM12-0026	€ 179,00
PRM12-0005	€ 159,00	MTS-BMT45-B2B3C-B	PRM12-0027	€ 139,00
PRM12-0006	€ 169,00	MTS-BMT55-B2B3C-B	PRM12-0028	€ 149,00
PRM12-0007	€ 179,00	MTS-BMT65-B2B3C-B	PRM12-0029	€ 159,00
PRM12-0008	€ 199,00	MTS-BMT75-B2B3C-B	PRM12-0030	€ 179,00

Cod. PROMO	Singola base / Single base	BMT DOPPIO	Cod. PROMO	Singola base / Single base
PRM12-0110	€ 279,00	MTS-BMT65-D1D2C	PRM12-0127	€ 259,00

Cod. PROMO	Singola base / Single base	BMT (DMG-MORI)	Cod. PROMO	Singola base / Single base
PRM12-0135	€ 179,00	MTS-BMT40-B1B4C-A	PRM12-0143	€ 159,00
PRM12-0136	€ 199,00	MTS-BMT60-B1B4C-A	PRM12-0144	€ 179,00
PRM12-0137	€ 179,00	MTS-BMT40-B2B3C-B	PRM12-0145	€ 159,00
PRM12-0138	€ 199,00	MTS-BMT60-B2B3C-B	PRM12-0146	€ 179,00

Cod. PROMO	Singola base / Single base	BIGLIA	Cod. PROMO	Singola base / Single base
PRM12-0013	€ 169,00	MTS-BG2S-B1B4C-A	PRM12-0035	€ 149,00
PRM12-0014	€ 179,00	MTS-BG2S-B2B3C-B	PRM12-0036	€ 159,00
PRM12-0015	€ 169,00	MTS-BG2L-B1B4C-A	PRM12-0037	€ 149,00
PRM12-0016	€ 179,00	MTS-BG2L-B2B3C-B	PRM12-0038	€ 159,00
PRM12-0139	€ 159,00	NEW MTS-BG3S-B1B4C-A	PRM12-0147	€ 139,00
PRM12-0140	€ 159,00	NEW MTS-BG3S-B2B3C-B	PRM12-0148	€ 139,00
PRM12-0141	€ 159,00	NEW MTS-BG3L-B1B4C-A	PRM12-0149	€ 139,00
PRM12-0142	€ 159,00	NEW MTS-BG3L-B2B3C-B	PRM12-0150	€ 139,00

Sistema di Tornitura e Troncatura Modulare / Turning and Parting-Off Modular System

DOOSAN STATIC 1L



B1B4C-A



B2B3C-B

DOOSAN STATIC 2L



B1B4C-A



B2B3C-B

NEW

TAKISAWA TAIWAN



B1B4C-A



B2B3C-B

NAKAMURA (CMZ)



B1B4C-A



B2B3C-B

CMZ (DMG-MORI)



B1B4C-A



B2B3C-B

POLYGONAL "C"



B1C-A



B3C-B

PROMO

3
PZ / PCS

Ordine minimo
Minimum order

**BASI A SCELTA
BASE OF YOUR CHOICE**

PROMO

5
PZ / PCS

Ordine minimo
Minimum order

Cod. PROMO	PREZZO / PRICE Singola Base / Single Base	DOOSAN STATIC	Cod. PROMO	PREZZO / PRICE Singola Base / Single Base
PRM12-0009	€ 139,00	MTS-DS1L-B1B4C-A	PRM12-0031	€ 119,00
PRM12-0010	€ 139,00	MTS-DS1L-B2B3C-B	PRM12-0032	€ 119,00
PRM12-0011	€ 159,00	MTS-DS2L-B1B4C-A	PRM12-0033	€ 139,00
PRM12-0012	€ 159,00	MTS-DS2L-B2B3C-B	PRM12-0034	€ 139,00
Cod. PROMO	Singola base / Single base	NAKAMURA (CMZ)	Cod. PROMO	Singola base / Single base
PRM12-0098	€ 179,00	MTS-NKM55-B1B4C-A	PRM12-0115	€ 159,00
PRM12-0099	€ 179,00	MTS-NKM55-B2B3C-B	PRM12-0116	€ 159,00
Cod. PROMO	Singola base / Single base	CMZ 30 (DMG-MORI)	Cod. PROMO	Singola base / Single base
PRM12-0100	€ 179,00	MTS-CMZ30-B1B4C-A	PRM12-0117	€ 159,00
PRM12-0101	€ 179,00	MTS-CMZ30-B2B3C-B	PRM12-0118	€ 159,00
Cod. PROMO	Singola base / Single base	TAKISAWA TAIWAN	Cod. PROMO	Singola base / Single base
PRM12-0151	€ 179,00	NEW MTS-TKT1M-B1B4C-A	PRM12-0155	€ 159,00
PRM12-0152	€ 179,00	NEW MTS-TKT1M-B2B3C-B	PRM12-0156	€ 159,00
Cod. PROMO	Singola base / Single base	POLYGONAL "C"	Cod. PROMO	Singola base / Single base
PRM12-0153	€ 259,00	MTS-C06-B1C-A	PRM12-0157	€ 239,00
PRM12-0154	€ 259,00	MTS-C06-B3C-B	PRM12-0158	€ 239,00

Sistema di Tornitura e Troncatura Modulare / Turning and Parting-Off Modular System

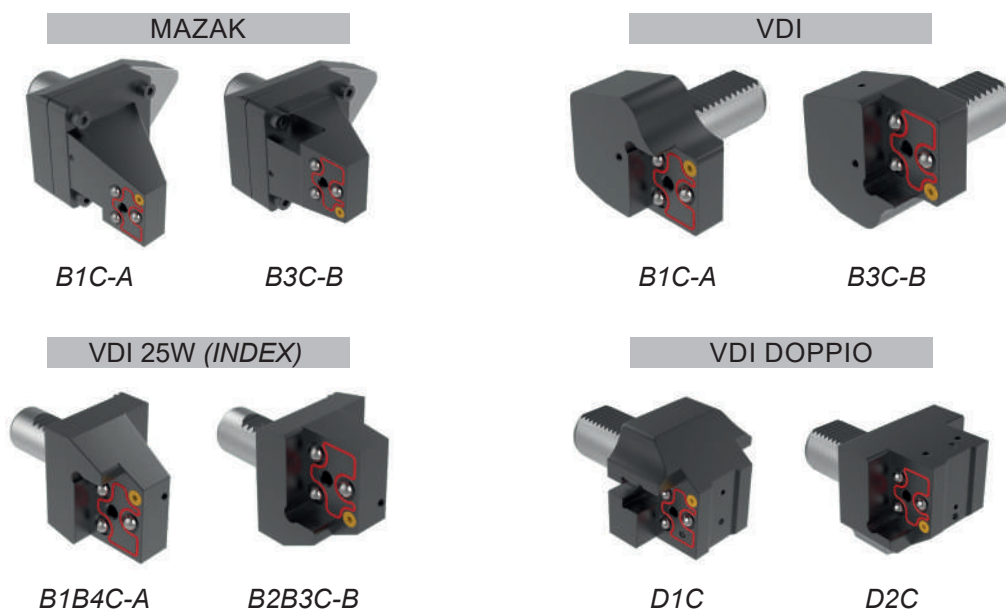

PROMO

3
PZ / PCS

Ordine minimo
Minimum order

**BASI A SCELTA
BASE OF YOUR CHOICE**

PROMO

5
PZ / PCS

Ordine minimo
Minimum order

Cod. PROMO	PREZZO / PRICE Singola Base / Single Base	MAZAK	Cod. PROMO	PREZZO / PRICE Singola Base / Single Base
PRM12-0094	€ 339,00	MTS-MZK40-B1C-A	PRM12-0111	€ 319,00
PRM12-0095	€ 369,00	MTS-MZK50-B1C-A	PRM12-0112	€ 349,00
PRM12-0096	€ 339,00	MTS-MZK40-B3C-B	PRM12-0113	€ 319,00
PRM12-0097	€ 369,00	MTS-MZK50-B3C-B	PRM12-0114	€ 349,00

Cod. PROMO	Singola base / Single base	VDI	Cod. PROMO	Singola base / Single base
PRM12-0017	€ 149,00	MTS-VDI30-B1C-A	PRM12-0039	€ 129,00
PRM12-0018	€ 159,00	MTS-VDI40-B1C-A	PRM12-0040	€ 139,00
PRM12-0019	€ 179,00	MTS-VDI50-B1C-A	PRM12-0041	€ 169,00
PRM12-0020	€ 149,00	MTS-VDI30-B3C-B	PRM12-0042	€ 129,00
PRM12-0021	€ 159,00	MTS-VDI40-B3C-B	PRM12-0043	€ 139,00
PRM12-0022	€ 179,00	MTS-VDI50-B3C-B	PRM12-0044	€ 169,00

Cod. PROMO	Singola base / Single base	VDI 25W (INDEX)	Cod. PROMO	Singola base / Single base
PRM12-0102	€ 169,00	MTS-VDI25W-B1B4C-A	PRM12-0119	€ 149,00
PRM12-0103	€ 169,00	MTS-VDI25W-B2B3C-B	PRM12-0120	€ 149,00

Cod. PROMO	Singola base / Single base	VDI DOPPIO	Cod. PROMO	Singola base / Single base
PRM12-0104	€ 239,00	MTS-VDI30-D1C	PRM12-0121	€ 219,00
PRM12-0105	€ 259,00	MTS-VDI40-D1C	PRM12-0122	€ 239,00
PRM12-0106	€ 269,00	MTS-VDI50-D1C	PRM12-0123	€ 249,00
PRM12-0107	€ 239,00	MTS-VDI30-D2C	PRM12-0124	€ 219,00
PRM12-0108	€ 259,00	MTS-VDI40-D2C	PRM12-0125	€ 239,00
PRM12-0109	€ 269,00	MTS-VDI50-D2C	PRM12-0126	€ 249,00

ModuTURN System

BASE + CARTUCCIA
BASE + CARTRIDGE

Basi e Cartucce Standard per Sistema di Tornitura Modulare / *Basement and Regular Cartridges for Modular Turning System*

Cartucce STANDARD REGULAR Cartridges

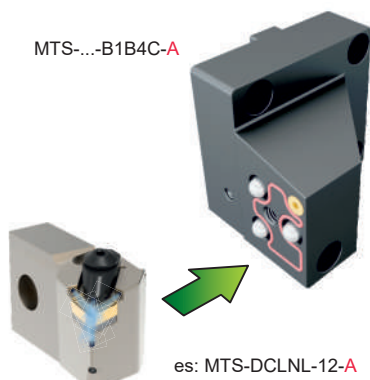
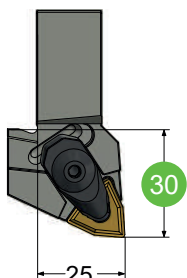

AcquaStream
by COMAND TOOL



accoppiare sempre Basi e Cartucce aventi la stessa lettera finale nel codice (A / B)
always match Base and Cartridges with the same end letter in the code (A / B)
es: MTS-BMT45-B1B4C-A > MTS-DCLNL-12-A | MTS-BMT45-B2B3C-B > MTS-DCLNR-12-B

Composizione Set / Set Composition

Cod. PROMO	n° 1 Base / Base MTS a tua scelta / of your choice p.14-15-16	n° 1 Cartuccia / Cartridge Standard / Regular	Prezzo / Price
PRM12-0159	BMT45 / VDI30 / BG3S / BG3L	a tua scelta tra of your choice between D-System S-System Threading Seeger Grooving vedi lista sotto see list below	€ 259,00
PRM12-0160	BMT40 / MBT55 / VDI40		€ 269,00
PRM12-0161	BMT60 / BMT65 / VDI50 / VDI25W		€ 289,00
PRM12-0162	BG2S / BG2L / NKM55 / CMZ30 / TKT1M		€ 289,00
PRM12-0163	BMT75		€ 319,00
PRM12-0164	DS1L / DS2L		€ 249,00
PRM12-0165	MZK40		€ 439,00
PRM12-0166	MZK50		€ 459,00
PRM12-0167	VDI30 DOPPIO		€ 339,00
PRM12-0168	VDI40 DOPPIO / BMT65 DOPPIO		€ 359,00
PRM12-0169	VDI50 DOPPIO	€ 369,00	

n°1 **Cartuccia Standard** a scelta da abbinare alla base / *Regular cartridge to match the base*

Cartucce **D-System** Cartridges

MTS-DCLNL/R-12-A/B
MTS-DCLNL/R-16-A/B
MTS-DCLNL/R-19-A/B
MTS-DCBNL/R-12-A/B
MTS-DCKNL/R-12-A/B
MTS-DDJNL/R-15-A/B
MTS-DSSNL/R-12-A/B
MTS-DSKNL/R-12-A/B
MTS-DTJNL/R-16-A/B
MTS-DVJNL/R-16-A/B
MTS-DWLNL/R-06-A/B
MTS-DWLNL/R-08-A/B

Cartucce **S-System** Cartridges

MTS-SCLCL/R-09-A/B
MTS-SCLCL/R-12-A/B
MTS-SDJCL/R-11-A/B
MTS-SDHCL/R-11-A/B
MTS-SRDCL/R-08-A/B
MTS-SRDCL/R-12-A/B
MTS-SSSCL/R-12-A/B
MTS-SVHBL/R-16-A/B
MTS-SVHCL/R-16-A/B
MTS-SVJBL/R-16-A/B
MTS-SVJCL/R-16-A/B
MTS-SVBN-16-A/B
MTS-SVVCN-16-A/B

Cartucce **Threading** Cartridges

MTS-DEL/R-16-A/B
MTS-DEL/R-22-A/B
MTS-SEL/R-16-A/B
MTS-SEL/R-22-A/B

Cartucce **Seeger** Cartridges

MTS-CESL/R-16-A/B

Cartucce **Grooving** Cartridges

MTS-CCGL/R-20-A/B
MTS-CCGL/R-30-A/B
MTS-CCGL/R-40-A/B
MTS-CCGL/R-50-A/B
MTS-CCGL/R-60-A/B



es. cartuccia
e.g. cartridge
D-System



es. cartuccia
e.g. cartridge
S-System



es. cartuccia
e.g. cartridge
Threading



es. cartuccia
e.g. cartridge
Seeger



es. cartuccia
e.g. cartridge
Grooving

Basi e Cartucce Medie per Sistema di Tornitura Modulare / *Basement and Medium Cartridges for Modular Turning System*

Cartucce MEDIE ideali per Basi Doppie / MEDIUM Cartridges ideal for Double Base



! accoppiare sempre Basi e Cartucce aventi la stessa lettera finale nel codice (A / B) ad eccezione delle Basi Doppie (MTS-...-D1D2C)
always match Base and Cartridges with the same end letter in the code (A / B) except Double Bases (MTS-...-D1D2C)
es: MTS-BMT45-B1B4C-A > MTS-DCLNL-12-AM | MTS-BMT45-B2B3C-B > MTS-DCLNR-12-BM

Composizione Set / Set Composition

Cod. PROMO	n° 1 Base / Base MTS a tua scelta / of your choice p.14-15-16	n° 1 Cartuccia / Cartridge Medie / Medium	Prezzo / Price
PRM12-0170	BMT45 / VDI30 / BG3S / BG3L	a tua scelta tra of your choice between D-System S-System Threading vedi lista sotto see list below	€ 269,00
PRM12-0171	BMT40 / MBT55 / VDI40		€ 279,00
PRM12-0172	BMT60 / BMT65 / VDI50 / VDI25W		€ 299,00
PRM12-0173	BG2S / BG2L / NKM55 / CMZ30 / TKT1M		€ 299,00
PRM12-0174	BMT75		€ 329,00
PRM12-0175	DS1L / DS2L		€ 259,00
PRM12-0176	MZK40		€ 449,00
PRM12-0177	MZK50		€ 469,00
PRM12-0178	VDI30 DOPPIO		€ 349,00
PRM12-0179	VDI40 DOPPIO / BMT65 DOPPIO		€ 369,00
PRM12-0180	VDI50 DOPPIO	€ 379,00	

n°1 **Cartuccia Media** a scelta da abbinare alla base / *Medium cartridge to match the base*

Cartucce D-System Cartridges

MTS-DCLNL/R-12-AM/BM
MTS-DDJNL/R-15-AM/BM

Cartucce S-System Cartridges

MTS-SDJCL/R-11-AM/BM
MTS-SVJCL/R-16-AM/BM

Cartucce Threading Cartridges

MTS-SEL/R-16-AM/BM

NEW



MTS-DCLNL/R-12-AM/BM



MTS-DDJNL/R-15-AM/BM

NEW



MTS-SDJCL/R-11-AM/BM



MTS-SVJCL/R-16-AM/BM

NEW



MTS-SEL/R-16-AM/BM

ModuTURN System

BASE + CARTUCCIA
BASE + CARTRIDGE

Basi e Cartucce Lunghe per Sistema di Tornitura Modulare / Basement and Long Cartridges for Modular Turning System

Cartucce LUNGHE ideali per Contropunta / LONG Cartridges ideal for Tailstock



! accoppiare sempre Basi e Cartucce aventi la stessa lettera finale nel codice (A / B)
always match Base and Cartridges with the same end letter in the code (A / B)
es: MTS-BMT45-B1B4C-A > MTS-DCLNL-12-AL | MTS-BMT45-B2B3C-B > MTS-DCLNR-12-BL

Composizione Set / Set Composition

Cod. PROMO	n° 1 Base / Base MTS a tua scelta / of your choice p.14-15-16	n° 1 Cartuccia / Cartridge Lunghe / Long	Prezzo / Price
PRM12-0181	BMT45 / VDI30 / BG3S / BG3L	a tua scelta tra of your choice between D-System S-System Threading vedi lista sotto see list below	€ 279,00
PRM12-0182	BMT40 / MBT55 / VDI40		€ 289,00
PRM12-0183	BMT60 / BMT65 / VDI50 / VDI25W		€ 309,00
PRM12-0184	BG2S / BG2L / NKM55 / CMZ30 / TKT1M		€ 309,00
PRM12-0185	BMT75		€ 339,00
PRM12-0186	DS1L / DS2L		€ 269,00
PRM12-0187	MZK40		€ 459,00
PRM12-0188	MZK50		€ 479,00

n°1 **Cartuccia Lunga** a scelta da abbinare alla base / Long cartridge to match the base

Cartucce **D-System** Cartridges

MTS-DCLNL/R-12-AL/BL
MTS-DDJNL/R-15-AL/BL
MTS-DWLNL/R-08-AL/BL

Cartucce **S-System** Cartridges

MTS-SDJCL/R-11-AL/BL
MTS-SVJBL/R-16-AL/BL
MTS-SVJCL/R-16-AL/BL

Cartucce **Threading** Cartridges

MTS-DEL/R-16-AL/BL



MTS-DCLNL/R-12-AL/BL



MTS-DDJNL/R-15-AL/BL



MTS-DWLNL/R-08-AL/BL



MTS-SDJCL/R-11-AL/BL



MTS-SVJBL/R-16-AL/BL



MTS-SVJCL/R-16-AL/BL



MTS-DEL/R-16-AL/BL

ModuTURN System

Cartucce Standard Regular Cartridges

Cartucce Standard per Sistema di Tornitura Modulare / Regular Cartridges for Modular Turning System

Cartucce Standard
Regular Cartridges

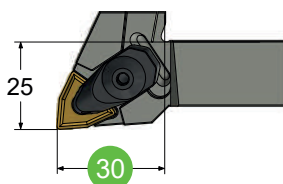

AcquaStream
by COMAND TOOL

3 / 5
CARTUCCE A SCELTA
OF YOUR CHOICE

Cod. PROMO	Ordine Minimo / Minimum Order	Prezzo / Price singola cartuccia / single cartridge
PRM12-0085	3 cartucce / cartridges	€ 119,00
PRM12-0086	5 cartucce / cartridges	€ 109,00

Cartucce **D-System** Cartridges



Cartucce **S-System** Cartridges

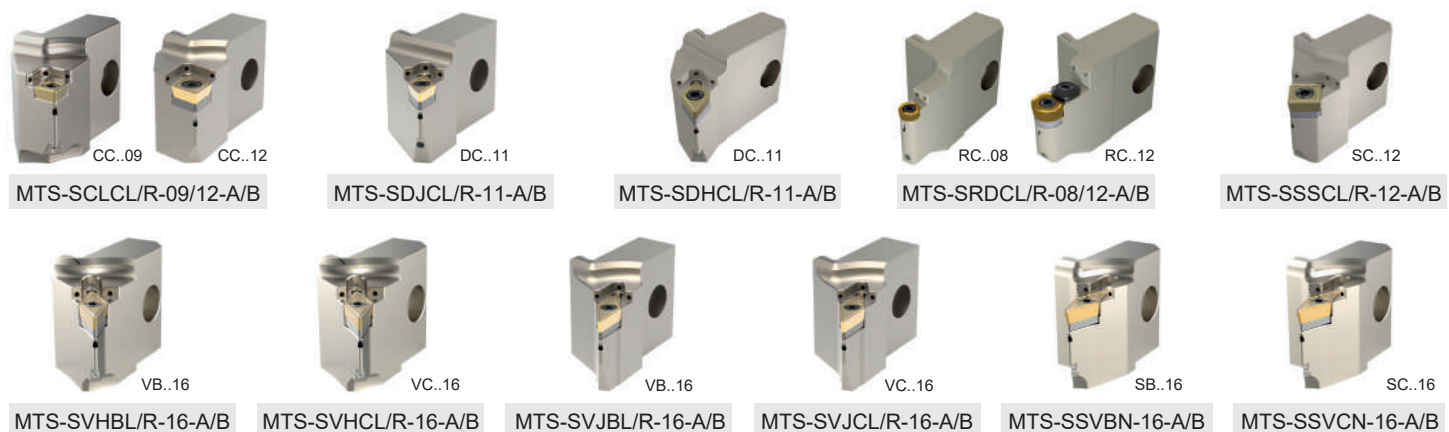

Cartucce **Threading** Cartridges



Cartucce **Seeger** Cartridges



Cartucce **Grooving** Cartridges



ModuTURN System

NEW

Cartucce Medie ideali per Basi Doppie
Medium Cartridges ideal for Double Base

Cartucce Medie per Sistema di Tornitura Modulare / Medium Cartridges for Turning Modular System

Cartucce Medie
Medium Cartridges

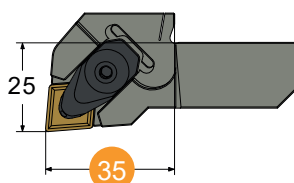

AcquaStream
by COMAND TOOL

3 / 5
CARTUCCE A SCELTA
OF YOUR CHOICE

Cod. PROMO	Ordine Minimo / Minimum Order	Prezzo / Price singola cartuccia / single cartridge
PRM12-0192	3 cartucce / cartridges	€ 129,00
PRM12-0193	5 cartucce / cartridges	€ 119,00

Cartucce **D-System** Cartridges



CN..12

MTS-DCLNL/R-12-AM/BM
MTS-DDJNL/R-15-AM/BM



DN..15

Cartucce **S-System** Cartridges



DC..11

MTS-SDJCL/R-11-AM/BM
MTS-SVJCL/R-16-AM/BM



VC..16

Cartucce **Threading** Cartridges



IR..16 / ER..16

MTS-SEL/R-16-AM/BM

ModuTURN System

Cartucce Lunghe ideali per Contropunta
Long Cartridges ideal for Tailstock

Cartucce Lunghe per Sistema di Tornitura Modulare / Long Cartridges for Turning Modular System

Cartucce Lunghe
Long Cartridges

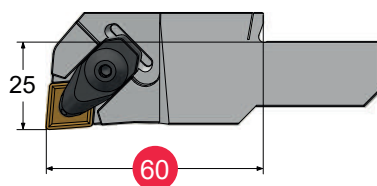

AcquaStream
by COMAND TOOL

3 / 5
CARTUCCE A SCELTA
OF YOUR CHOICE

Cod. PROMO	Ordine Minimo / Minimum Order	Prezzo / Price singola cartuccia / single cartridge
PRM12-0132	3 cartucce / cartridges	€ 139,00
PRM12-0133	5 cartucce / cartridges	€ 129,00

Cartucce **D-System** Cartridges



CN..12

MTS-DCLNL/R-12-AL/BL
MTS-DDJNL/R-15-AL/BL
MTS-DWLNL/R-08-AL/BL



DN..15



WN..08

Cartucce **S-System** Cartridges



DC..11

MTS-SDJCL/R-11-AL/BL
MTS-SVJBL/R-16-AL/BL
MTS-SVJCL/R-16-AL/BL



VB..16



VC..16

Cartucce **Threading** Cartridges



IR..16 / ER..16

MTS-DEL/R-16-AL/BL

Scanalatura Modulare

Frontale / Modular Face Grooving

UTENSILE + CARTUCCE + INSERTI
TOOLHOLDER + CARTRIDGES + INSERTS

Acqua
by COMAND TOOL

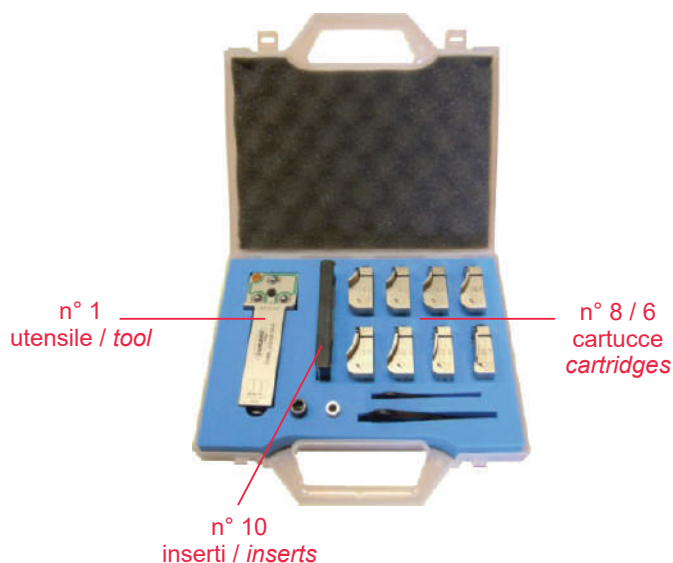

SERIE COMBINATA / COMBINED SERIES

CARTUCCE CORTE + LUNGHE / SHORT + LONG CARTRIDGES

Composizione Set / Set Composition

Cod. PROMO	n° 1 Utensile / Tool	n° 8 Cartucce / Cartridges		n° 10 Inserti	Prezzo / Price
		Corte / Short	Lunghe / Long		
PRM08-0097	CHML 2020K 34-A	CCFR 2530 30-10-A CCFR 3038 30-10-A	CCFR 6075 30-20-A CCFR 75100 30-20-A	3 mm CTSN2230GT PG4540	€ 769,00
PRM08-0098	CHML 2525M 34-A	CCFR 3848 30-10-A CCFR 4860 30-10-A	CCFR 100200 30-20-A CCFR 200-> 30-20-A		€ 779,00
PRM08-0099	CHMR 2020K 34-B	CCFL 2530 30-10-B CCFL 3038 30-10-B	CCFL 6075 30-20-B CCFL 75100 30-20-B		€ 769,00
PRM08-0100	CHMR 2525M 34-B	CCFL 3848 30-10-B CCFL 4860 30-10-B	CCFL 100200 30-20-B CCFL 200-> 30-20-B		€ 779,00

Composizione Set / Set Composition

Cod. PROMO	n° 1 Utensile / Tool	n° 6 Cartucce / Cartridges		n° 10 Inserti	Prezzo / Price
		Corte / Short	Lunghe / Long		
PRM08-0101	CHML 2020K 34-A	CCFR 3048 40-12-A CCFR 4860 40-12-A	CCFR 75100 40-24-A CCFR 100150 40-24-A	4 mm CTSN2540GT PG4540	€ 639,00
PRM08-0102	CHML 2525M 34-A	CCFR 6075 40-12-A	CCFR 150-> 40-24-A		€ 649,00
PRM08-0103	CHMR 2020K 34-B	CCFL 3048 40-12-B CCFL 4860 40-12-B	CCFL 75100 40-24-B CCFL 100150 40-24-B		€ 639,00
PRM08-0104	CHMR 2525M 34-B	CCFL 6075 40-12-B	CCFL 150-> 40-24-B		€ 649,00

Scanalatura Modulare

Frontale / Modular Face Grooving

Stream



CHMR...-B

PG4540



**Compra 1 Utensile
Buy 1 Toolholders
10 INSERTI GRATIS
FREE INSERTS**

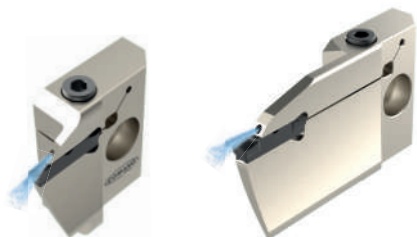

CCFL...-B



SERIE COMBINATA / COMBINED SERIES

CARTUCCE CORTE + LUNGHE / SHORT + LONG CARTRIDGES

Composizione Set / Set Composition

Cod. PROMO	n° 1 Utensile / Tool	n° 6 Cartucce / Cartridges		n° 10 Inserti	Prezzo / Price
		Corte / Short	Lunghe / Long		
PRM08-0105	CHML 2020K 34-A	CCFR 4255 50-22-A CCFR 5575 50-22-A	CCFR 130200 50-45-A CCFR 200450 50-45-A	5 mm CTSN2550GT PG4540	€ 639,00
PRM08-0106	CHML 2525M 34-A	CCFR 75130 50-22-A	CCFR 450-> 50-45-A		€ 649,00
PRM08-0107	CHMR 2020K 34-B	CCFL 4255 50-22-B CCFL 5575 50-22-B	CCFL 130200 50-45-B CCFL 200450 50-45-B		€ 639,00
PRM08-0108	CHMR 2525M 34-B	CCFL 75130 50-22-B	CCFL 450-> 50-45-B		€ 649,00

Composizione Set / Set Composition

Cod. PROMO	n° 1 Utensile / Tool	n° 6 Cartucce / Cartridges		n° 10 Inserti	Prezzo / Price
		Corte / Short	Lunghe / Long		
PRM08-0109	CHML 2020K 34-A	CCFR 4255 60-22-A CCFR 5575 60-22-A	CCFR 130200 60-45-A CCFR 200450 60-45-A	6 mm CTSN2560GT PG4540	€ 639,00
PRM08-0110	CHML 2525M 34-A	CCFR 75130 60-22-A	CCFR 450-> 60-45-A		€ 649,00
PRM08-0111	CHMR 2020K 34-B	CCFL 4255 60-22-B CCFL 5575 60-22-B	CCFL 130200 60-45-B CCFL 200450 60-45-B		€ 639,00
PRM08-0112	CHMR 2525M 34-B	CCFL 75130 60-22-B	CCFL 450-> 60-45-B		€ 649,00

Scanalatura Modulare

Frontale / Modular Face Grooving

UTENSILE + CARTUCCE + INSERTI
TOOLHOLDER + CARTRIDGES + INSERTS



SERIE CARTUCCE CORTE / SHORT CARTRIDGES SERIES

Composizione Set / Set Composition

Cod. PROMO	n° 1 Utensile / Tool	n° 8 Cartucce / Cartridges	n° 10 Inserti	Prezzo / Price
PRM08-0113	CHML 2020K 34-A	CCFR...20-08-A	2 mm	€ 769,00
PRM08-0114	CHML 2525M 34-A	CCFR...20-08-A		€ 779,00
PRM08-0115	CHMR 2020K 34-B	CCFL...20-08-B	CTSN2220GT PG4540	€ 769,00
PRM08-0116	CHMR 2525M 34-B	CCFL...20-08-B		€ 779,00

Cod. PROMO	n° 1 Utensile / Tool	n° 8 Cartucce / Cartridges	n° 10 Inserti	Prezzo / Price
PRM08-0001	CHML 2020K 34-A	CCFR...30-10-A	3 mm	€ 769,00
PRM08-0002	CHML 2525M 34-A	CCFR...30-10-A		€ 779,00
PRM08-0003	CHMR 2020K 34-B	CCFL...30-10-B	CTSN2230GT PG4540	€ 769,00
PRM08-0004	CHMR 2525M 34-B	CCFL...30-10-B		€ 779,00

Cod. PROMO	n° 1 Utensile / Tool	n° 6 Cartucce / Cartridges	n° 10 Inserti	Prezzo / Price
PRM08-0005	CHML 2020K 34-A	CCFR...40-12-A	4 mm	€ 639,00
PRM08-0006	CHML 2525M 34-A	CCFR...40-12-A		€ 649,00
PRM08-0007	CHMR 2020K 34-B	CCFL...40-12-B	CTSN2540GT PG4540	€ 639,00
PRM08-0008	CHMR 2525M 34-B	CCFL...40-12-B		€ 649,00

SERIE CARTUCCE LUNGHE / LONG CARTRIDGES SERIES

Composizione Set / Set Composition

Cod. PROMO	n° 1 Utensile / Tool	n° 4 Cartucce / Cartridges	n° 10 Inserti	Prezzo / Price
PRM08-0009	CHML 2020K 34-A	CCFR...30-20-A	3 mm	€ 499,00
PRM08-0010	CHML 2525M 34-A	CCFR...30-20-A		€ 509,00
PRM08-0011	CHMR 2020K 34-B	CCFL...30-20-B	CTSN2230GT PG4540	€ 499,00
PRM08-0012	CHMR 2525M 34-B	CCFL...30-20-B		€ 509,00

Cod. PROMO	n° 1 Utensile / Tool	n° 6 Cartucce / Cartridges	n° 10 Inserti	Prezzo / Price
PRM08-0013	CHML 2020K 34-A	CCFR...40-24-A	4 mm	€ 639,00
PRM08-0014	CHML 2525M 34-A	CCFR...40-24-A		€ 649,00
PRM08-0015	CHMR 2020K 34-B	CCFL...40-24-B	CTSN2540GT PG4540	€ 639,00
PRM08-0016	CHMR 2525M 34-B	CCFL...40-24-B		€ 649,00

Scanalatura Modulare

Radiale / Modular Radial Grooving

UTENSILE + CARTUCCE + INSERTI
TOOLHOLDER + CARTRIDGES + INSERTS



SERIE COMBINATA / COMBINED SERIES

CARTUCCE CORTE + LUNGHE / SHORT + LONG CARTRIDGES

Composizione Set / Set Composition

Cod. PROMO	n° 1 Utensile / Tool	n° 2 Cartucce / Cartridges	n° 10 Inserti	Prezzo / Price
PRM08-0017	CHML 2020K 34-A	CCGL 20 09-A	2 mm	€ 359,00
PRM08-0018	CHML 2525M 34-A	CCGL 20 18-A		€ 369,00
PRM08-0019	CHMR 2020K 34-B	CCGR 20 09-B	CTSN2220GT PG4540	€ 359,00
PRM08-0020	CHMR 2525M 34-B	CCGR 20 18-B		€ 369,00
Cod. PROMO	n° 1 Utensile / Tool	n° 2 Cartucce / Cartridges	n° 10 Inserti	Prezzo / Price
PRM08-0021	CHML 2020K 34-A	CCGL 30 10-A	3 mm	€ 369,00
PRM08-0022	CHML 2525M 34-A	CCGL 30 20-A		€ 379,00
PRM08-0023	CHMR 2020K 34-B	CCGR 30 10-B	CTSN2230GT PG4540	€ 369,00
PRM08-0024	CHMR 2525M 34-B	CCGR 30 20-B		€ 379,00
Cod. PROMO	n° 1 Utensile / Tool	n° 2 Cartucce / Cartridges	n° 10 Inserti	Prezzo / Price
PRM08-0025	CHML 2020K 34-A	CCGL 40 12-A	4 mm	€ 379,00
PRM08-0026	CHML 2525M 34-A	CCGL 40 24-A		€ 389,00
PRM08-0027	CHMR 2020K 34-B	CCGR 40 12-B	CTSN2540GT PG4540	€ 379,00
PRM08-0028	CHMR 2525M 34-B	CCGR 40 24-B		€ 389,00
Cod. PROMO	n° 1 Utensile / Tool	n° 2 Cartucce / Cartridges	n° 10 Inserti	Prezzo / Price
PRM08-0029	CHML 2020K 34-A	CCGL 50 15-A	5 mm	€ 389,00
PRM08-0030	CHML 2525M 34-A	CCGL 50 30-A		€ 399,00
PRM08-0031	CHMR 2020K 34-B	CCGR 50 15-B	CTSN2550GT PG4540	€ 389,00
PRM08-0032	CHMR 2525M 34-B	CCGR 50 30-B		€ 399,00
Cod. PROMO	n° 1 Utensile / Tool	n° 2 Cartucce / Cartridges	n° 10 Inserti	Prezzo / Price
PRM08-0033	CHML 2020K 34-A	CCGL 60 20-A	6 mm	€ 389,00
PRM08-0034	CHML 2525M 34-A	CCGL 60 40-A		€ 399,00
PRM08-0035	CHMR 2020K 34-B	CCGR 60 20-B	CTSN2560GT PG4540	€ 389,00
PRM08-0036	CHMR 2525M 34-B	CCGR 60 40-B		€ 399,00

Scanalatura - Troncatura Integrale

Utensili per Scanalatura - Troncatura Esterna / Holder for Grooving and Parting-Off

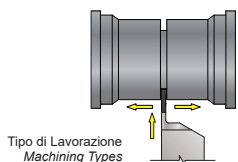

**Compra 1 Utensile
Buy 1 Toolholders**
**10 INSERTI GRATIS
FREE INSERTS**

PG4540

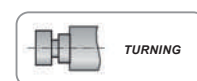

Composizione Set / Set Composition

Cod. PROMO	Utensile / Tool	n° 10 Inserti / Inserts	T-max	Insert W	Prezzo / Price
PRM08-0037	CEGR 1616K 20-10	CTSN2220GT PG4540	10	2,0	€ 169,00
PRM08-0038	CEGR 2020K 20-12	CTSN2220GT PG4540	12	2,0	€ 169,00
PRM08-0039	CEGR 2020K 20-18	CTSN2220GT PG4540	18	2,0	€ 169,00
PRM08-0040	CEGR 2525M 20-12	CTSN2220GT PG4540	12	2,0	€ 169,00
PRM08-0041	CEGR 2525M 20-18	CTSN2220GT PG4540	18	2,0	€ 169,00
PRM08-0042	CEGR 1616K 30-14	CTSN2230GT PG4540	14	3,0	€ 179,00
PRM08-0043	CEGR 2020K 30-12	CTSN2230GT PG4540	12	3,0	€ 179,00
PRM08-0044	CEGR 2020K 30-18	CTSN2230GT PG4540	18	3,0	€ 179,00
PRM08-0045	CEGR 2525M 30-12	CTSN2230GT PG4540	12	3,0	€ 179,00
PRM08-0046	CEGR 2525M 30-18	CTSN2230GT PG4540	18	3,0	€ 179,00
PRM08-0047	CEGR 3232P 30-18	CTSN2230GT PG4540	18	3,0	€ 179,00
PRM08-0048	CEGR 2020K 40-12	CTSN2540GT PG4540	12	4,0	€ 189,00
PRM08-0049	CEGR 2020K 40-20	CTSN2540GT PG4540	20	4,0	€ 189,00
PRM08-0050	CEGR 2525M 40-12	CTSN2540GT PG4540	12	4,0	€ 189,00
PRM08-0051	CEGR 2525M 40-20	CTSN2540GT PG4540	20	4,0	€ 189,00
PRM08-0052	CEGR 3232P 40-20	CTSN2540GT PG4540	20	4,0	€ 189,00
PRM08-0053	CEGL 1616K 20-10	CTSN2220GT PG4540	10	2,0	€ 169,00
PRM08-0054	CEGL 2020K 20-12	CTSN2220GT PG4540	12	2,0	€ 169,00
PRM08-0055	CEGL 2020K 20-18	CTSN2220GT PG4540	18	2,0	€ 169,00
PRM08-0056	CEGL 2525M 20-12	CTSN2220GT PG4540	12	2,0	€ 169,00
PRM08-0057	CEGL 2525M 20-18	CTSN2220GT PG4540	18	2,0	€ 169,00
PRM08-0058	CEGL 1616K 30-14	CTSN2230GT PG4540	14	3,0	€ 179,00
PRM08-0059	CEGL 2020K 30-12	CTSN2230GT PG4540	12	3,0	€ 179,00
PRM08-0060	CEGL 2020K 30-18	CTSN2230GT PG4540	18	3,0	€ 179,00
PRM08-0061	CEGL 2525M 30-12	CTSN2230GT PG4540	12	3,0	€ 179,00
PRM08-0062	CEGL 2525M 30-18	CTSN2230GT PG4540	18	3,0	€ 179,00
PRM08-0063	CEGL 3232P 30-18	CTSN2230GT PG4540	18	3,0	€ 179,00
PRM08-0064	CEGL 2020K 40-12	CTSN2540GT PG4540	12	4,0	€ 189,00
PRM08-0065	CEGL 2020K 40-20	CTSN2540GT PG4540	20	4,0	€ 189,00
PRM08-0066	CEGL 2525M 40-12	CTSN2540GT PG4540	12	4,0	€ 189,00
PRM08-0067	CEGL 2525M 40-20	CTSN2540GT PG4540	20	4,0	€ 189,00
PRM08-0068	CEGL 3232P 40-20	CTSN2540GT PG4540	20	4,0	€ 189,00

Scanalatura - Troncatura Integrale

Utensili per Scanalatura - Troncatura Esterna / Holder for Grooving and Parting-Off

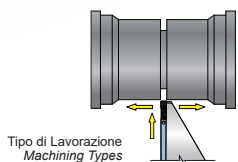

**Compra 1 Utensile
Buy 1 Toolholders**
**10 INSERTI GRATIS
FREE INSERTS**

PG4540

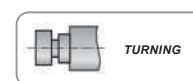

Composizione Set / Set Composition

Cod. PROMO	Utensile / Tool	n° 10 Inserti / Inserts	T-max	Insert W	Prezzo / Price
PRM08-0069	A-CEPR-1010X 20-10	CTSN2220GT PG4540	10	2,0	€ 179,00
PRM08-0070	A-CEPR-1212K 20-12	CTSN2220GT PG4540	12	2,0	€ 179,00
PRM08-0071	A-CEPR-1212K 30-12	CTSN2230GT PG4540	12	3,0	€ 189,00
PRM08-0072	A-CEPR-1616K 20-12	CTSN2220GT PG4540	12	2,0	€ 189,00
PRM08-0073	A-CEPR-1616K 20-18	CTSN2220GT PG4540	18	2,0	€ 189,00
PRM08-0074	A-CEPR-1616K 30-12	CTSN2230GT PG4540	12	3,0	€ 199,00
PRM08-0075	A-CEPR-1616K 30-18	CTSN2230GT PG4540	18	3,0	€ 199,00
PRM08-0076	A-CEPR-2020K 20-18	CTSN2220GT PG4540	18	2,0	€ 189,00
PRM08-0077	A-CEPR-2020K 30-21	CTSN2230GT PG4540	21	3,0	€ 199,00
PRM08-0078	A-CEPR-2525K 30-21	CTSN2230GT PG4540	21	3,0	€ 209,00

Composizione Set / Set Composition

Cod. PROMO	Utensile / Tool	n° 10 Inserti / Inserts	T-max	Insert W	Prezzo / Price
PRM08-0079	A-CEPL-1010X 20-10	CTSN2220GT PG4540	10	2,0	€ 179,00
PRM08-0080	A-CEPL-1212K 20-12	CTSN2220GT PG4540	12	2,0	€ 179,00
PRM08-0081	A-CEPL-1212K 30-12	CTSN2230GT PG4540	12	3,0	€ 189,00
PRM08-0082	A-CEPL-1616K 20-12	CTSN2220GT PG4540	12	2,0	€ 189,00
PRM08-0083	A-CEPL-1616K 20-18	CTSN2220GT PG4540	18	2,0	€ 189,00
PRM08-0084	A-CEPL-1616K 30-12	CTSN2230GT PG4540	12	3,0	€ 199,00
PRM08-0085	A-CEPL-1616K 30-18	CTSN2230GT PG4540	18	3,0	€ 199,00
PRM08-0086	A-CEPL-2020K 20-18	CTSN2220GT PG4540	18	2,0	€ 189,00
PRM08-0087	A-CEPL-2020K 30-21	CTSN2230GT PG4540	21	3,0	€ 199,00
PRM08-0088	A-CEPL-2525K 30-21	CTSN2230GT PG4540	21	3,0	€ 209,00



Lama per Troncare

LAMA + PORTALAMA + INSERTI
BLADE + TOOL HOLDER + INSERTS

Lama per Troncare con refrigerante / Cutting Blade with through coolant

AcquaStream
by COMAND TOOL

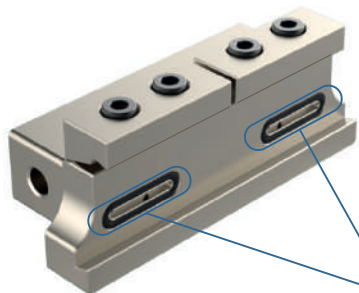
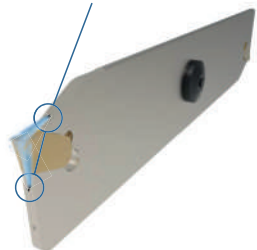

AcquaStream
by COMAND TOOL

Compra 1 Lama / Buy 1 Cutting Blade
PORTALAMA + INSERTI
TOOLHOLDER + INSERTS
GRATIS / FREE

CG4125



Composizione Set / Set Composition

Cod. PROMO	Utensile / Tool	Portalama / Tool Holder	n° 10 Inserti / Inserts	Prezzo / Price
PRM08-0117	A-SGIH 32-3	A-PLC 25-32	GTN3 GM CG4125	€ 209,00
PRM08-0118	A-SGIH 32-4	A-PLC 25-32	GTN4 GM CG4125	€ 209,00

Lama per Troncare

LAMA + CHIAVE + INSERTI
BLADE + KEY + INSERTS

Lama per Troncare / Cutting Blade



Compra 1 Lama
Buy 1 Cutting Blade
10 INSERTI GRATIS
FREE INSERTS

PG4325



GP







Composizione Set / Set Composition

Cod. PROMO	Utensile / Tool	Chiave / Key	n° 10 Inserti / Inserts	Prezzo / Price
PRM08-0089	LACG 26-3	CLG 480	CTSN2230GP PG4345	€ 169,00
PRM08-0090	LACG 26-4	CLG 480	CTSN2540GP PG4345	€ 169,00
PRM08-0091	LACG 32-3	CLG 480	CTSN2230GP PG4345	€ 169,00
PRM08-0092	LACG 32-4	CLG 480	CTSN2540GP PG4345	€ 169,00

Inserti Monolaterali

Inserti Monolaterali per Troncatura e Scanalatura / *Monolateral Inserts for Grooving and Parting-Off*

Inserti / Inserts	Codice Inserto / Insert Code	Prezzo per singolo Inserto / Single Insert price	
		Ordine minimo / Minimum order	Ordine minimo / Minimum order
	CTSN1020GT PG4540	n° 50 pz € 8,00	n° 100 pz € 7,00
	CTSN1030GT PG4540	€ 8,00	€ 7,00
	CTSN1030GP PG4345	€ 8,00	€ 7,00
	CTSN1240GP PG4345	€ 8,00	€ 7,00

Troncatura Monolaterale

Monolateral Parting-Off

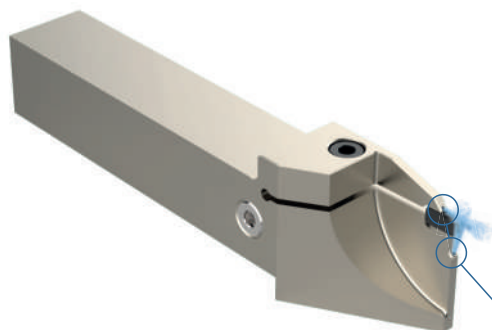

AcquaStream
by COMAND TOOL

Compra 1 Utensile
Buy 1 Toolholders
10 INSERTI GRATIS
FREE INSERTS

PG4325



GP



Composizione Set / Set Composition

Cod. PROMO	Utensile / Tool	n° 10 Inserti / Inserts	T-max	Insert W	Prezzo / Price
PRM08-0119	A-CEGR 2020K 30-26	CTSN1030GP PG4345	26	3,0	€ 149,00
PRM08-0120	A-CEGR 2020K 30-33	CTSN1030GP PG4345	33	3,0	€ 149,00
PRM08-0137	A-CEGR 2525M 30-26	CTSN1030GP PG4345	26	3,0	€ 159,00
PRM08-0138	A-CEGR 2525M 30-33	CTSN1030GP PG4345	33	3,0	€ 159,00
PRM08-0121	A-CEGR 2525M 40-28	CTSN1240GP PG4345	28	4,0	€ 159,00
PRM08-0122	A-CEGR 2525M 40-36	CTSN1240GP PG4345	36	4,0	€ 159,00
PRM08-0123	A-CEGL 2020K 30-26	CTSN1030GP PG4345	26	3,0	€ 149,00
PRM08-0124	A-CEGL 2020K 30-33	CTSN1030GP PG4345	33	3,0	€ 149,00
PRM08-0139	A-CEGL 2525M 30-26	CTSN1030GP PG4345	26	3,0	€ 159,00
PRM08-0140	A-CEGL 2525M 30-33	CTSN1030GP PG4345	33	3,0	€ 159,00
PRM08-0125	A-CEGL 2525M 40-28	CTSN1240GP PG4345	28	4,0	€ 159,00
PRM08-0126	A-CEGL 2525M 40-36	CTSN1240GP PG4345	36	4,0	€ 159,00

Mini-Scanalatura

Mini-Grooving



AcquaStream
by COMAND TOOL

**Compra 1 Utensile
Buy 1 Toolholders**
**10 INSERTI GRATIS
FREE INSERTS**

PG4540

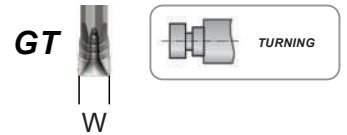
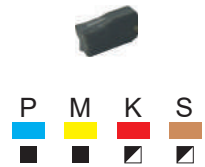

Composizione Set / Set Composition

Cod. PROMO	Utensile / Tool	n° 10 Inserti / Inserts	D	T-max	Insert W	Prezzo / Price
PRM08-0127	CIGR 0012K 20	CTSN1020GT PG4540	16	5	2,0	€ 159,00
PRM08-0128	CIGR 0012K 30	CTSN1030GT PG4540	16	5	3,0	€ 159,00
PRM08-0129	CIGR 0016M 20	CTSN1020GT PG4540	20	6	2,0	€ 179,00
PRM08-0130	CIGR 0016M 30	CTSN1030GT PG4540	20	6	3,0	€ 179,00
PRM08-0131	CIGL 0012K 20	CTSN1020GT PG4540	16	5	2,0	€ 159,00
PRM08-0132	CIGL 0012K 30	CTSN1030GT PG4540	16	5	3,0	€ 159,00
PRM08-0133	CIGL 0016M 20	CTSN1020GT PG4540	20	6	2,0	€ 179,00
PRM08-0134	CIGL 0016M 30	CTSN1030GT PG4540	20	6	3,0	€ 179,00

Scanalatura

Utensili per Scanalatura Interna / Holder for Internal Grooving



AcquaStream
by COMAND TOOL

**Compra 1 Utensile
Buy 1 Toolholders**
**10 INSERTI GRATIS
FREE INSERTS**

PG4540

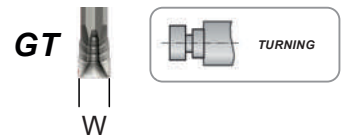
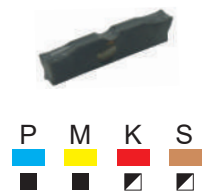

Composizione Set / Set Composition

Cod. PROMO	Utensile / Tool	n° 10 Inserti / Inserts	D	T-max	Insert W	Prezzo / Price
PRM08-0093	CIGR 0020Q 30	CTSN2230GT PG4540	25	7	3,0	€ 219,00
PRM08-0094	CIGR 0020Q 40	CTSN2540GT PG4540	28	9	4,0	€ 219,00
PRM08-0095	CIGR 0025R 30	CTSN2230GT PG4540	32	9	3,0	€ 239,00
PRM08-0096	CIGR 0025R 40	CTSN2540GT PG4540	32	9	4,0	€ 239,00
PRM08-0135	CIGR 0032S 30	CTSN2230GT PG4540	38	11	3,0	€ 279,00
PRM08-0136	CIGR 0032S 40	CTSN2540GT PG4540	38	11	4,0	€ 279,00

Tornitura Esterna *AcquaStream*

Utensili per Tornitura Esterna AcquaStream / External Turning Tools AcquaStream

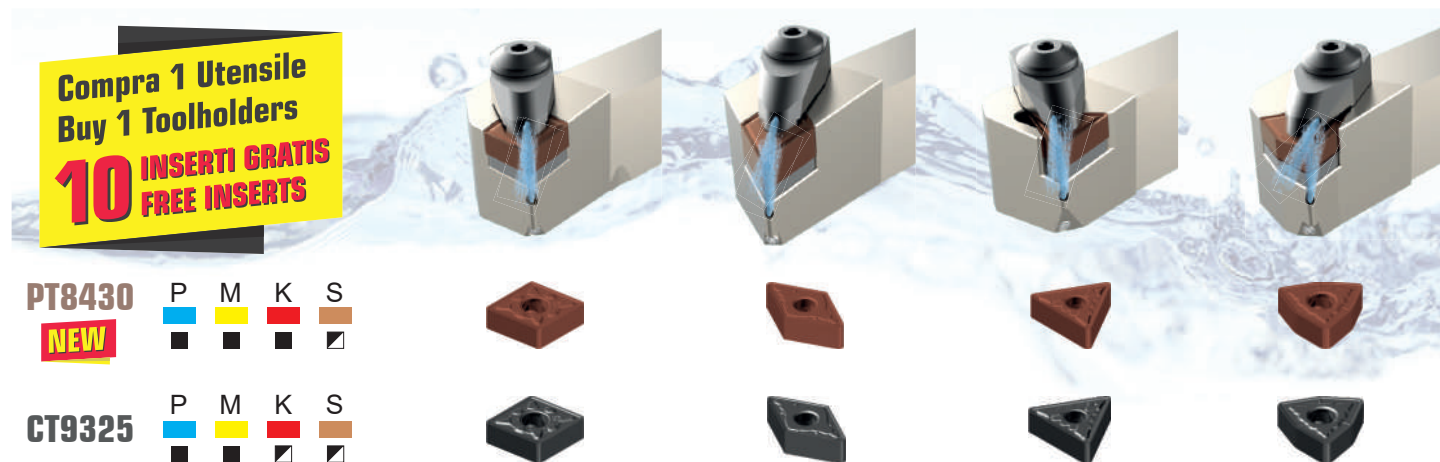

Composizione Set / Set Composition

Cod. PROMO	Utensile / Tool	n° 10 Inserti / Inserts	Prezzo / Price
PRM01-0073	A-DCLNR 2020K 12	CNMG120408CMR PT8430 ●	€ 129,00
PRM01-0074	A-DCLNR 2525M 12	CNMG120408CMR PT8430 ●	€ 139,00
PRM01-0075	A-DCLNL 2020K 12	CNMG120408CMR PT8430 ●	€ 129,00
PRM01-0076	A-DCLNL 2525M 12	CNMG120408CMR PT8430 ●	€ 139,00
PRM01-0077	A-DCLNR 2020K 12	CNMG120404CM CT9325 ●	€ 129,00
PRM01-0078	A-DCLNR 2525M 12	CNMG120404CM CT9325 ●	€ 139,00
PRM01-0079	A-DCLNL 2020K 12	CNMG120404CM CT9325 ●	€ 129,00
PRM01-0080	A-DCLNL 2525M 12	CNMG120404CM CT9325 ●	€ 139,00
PRM01-0081	A-DDJNR 2020K 15	DNMG150608CMR PT8430 ●	€ 129,00
PRM01-0082	A-DDJNR 2525M 15	DNMG150608CMR PT8430 ●	€ 139,00
PRM01-0083	A-DDJNL 2020K 15	DNMG150608CMR PT8430 ●	€ 129,00
PRM01-0084	A-DDJNL 2525M 15	DNMG150608CMR PT8430 ●	€ 139,00
PRM01-0085	A-DDJNR 2020K 15	DNMG150604CM CT9325 ●	€ 129,00
PRM01-0086	A-DDJNR 2525M 15	DNMG150604CM CT9325 ●	€ 139,00
PRM01-0087	A-DDJNL 2020K 15	DNMG150604CM CT9325 ●	€ 129,00
PRM01-0088	A-DDJNL 2525M 15	DNMG150604CM CT9325 ●	€ 139,00
PRM01-0089	A-DTJNR 2020K 16	TNMG160408CMR PT8430 ●	€ 129,00
PRM01-0090	A-DTJNR 2525M 16	TNMG160408CMR PT8430 ●	€ 139,00
PRM01-0091	A-DTJNL 2020K 16	TNMG160408CMR PT8430 ●	€ 129,00
PRM01-0092	A-DTJNL 2525M 16	TNMG160408CMR PT8430 ●	€ 139,00
PRM01-0093	A-DTJNR 2020K 16	TNMG160404CM CT9325 ●	€ 129,00
PRM01-0094	A-DTJNR 2525M 16	TNMG160404CM CT9325 ●	€ 139,00
PRM01-0095	A-DTJNL 2020K 16	TNMG160404CM CT9325 ●	€ 129,00
PRM01-0096	A-DTJNL 2525M 16	TNMG160404CM CT9325 ●	€ 139,00
PRM01-0097	A-DWLNR 2020K 08	WNMG080408CMR PT8430 ●	€ 129,00
PRM01-0098	A-DWLNR 2525M 08	WNMG080408CMR PT8430 ●	€ 139,00
PRM01-0099	A-DWLNL 2020K 08	WNMG080408CMR PT8430 ●	€ 129,00
PRM01-0100	A-DWLNL 2525M 08	WNMG080408CMR PT8430 ●	€ 139,00
PRM01-0101	A-DWLNR 2020K 08	WNMG080404CM CT9325 ●	€ 129,00
PRM01-0102	A-DWLNR 2525M 08	WNMG080404CM CT9325 ●	€ 139,00
PRM01-0103	A-DWLNL 2020K 08	WNMG080404CM CT9325 ●	€ 129,00
PRM01-0104	A-DWLNL 2525M 08	WNMG080404CM CT9325 ●	€ 139,00

Tornitura Interna A...MTFNR/L 16

Utensili per Tornitura Interna / Internal Turning Tools



**Compra 1 Utensile
Buy 1 Toolholders**
**10 INSERTI GRATIS
FREE INSERTS**

CT9325



PT8430 **NEW**



Composizione Set / Set Composition

Cod. PROMO	n° 1 Utensile / Tool	n° 10 Inserti / Inserts	n° 1 Chiave / Key	Prezzo / Price
PRM01-0029	A25R MTFNR 16	TNMG160404CM CT9325 ●	CBR25	€ 129,00
PRM01-0030	A32S MTFNR 16	TNMG160404CM CT9325 ●	CBR25	€ 139,00
PRM01-0031	A25R MTFNL 16	TNMG160404CM CT9325 ●	CBR25	€ 129,00
PRM01-0032	A32S MTFNL 16	TNMG160404CM CT9325 ●	CBR25	€ 139,00
PRM01-0033	A25R MTFNR 16	TNMG160408CMR PT8430 ●	CBR25	€ 129,00
PRM01-0034	A32S MTFNR 16	TNMG160408CMR PT8430 ●	CBR25	€ 139,00
PRM01-0035	A25R MTFNL 16	TNMG160408CMR PT8430 ●	CBR25	€ 129,00
PRM01-0036	A32S MTFNL 16	TNMG160408CMR PT8430 ●	CBR25	€ 139,00

Tornitura Interna A...PCLNR/L 12

Utensili per Tornitura Interna / Internal Turning Tools

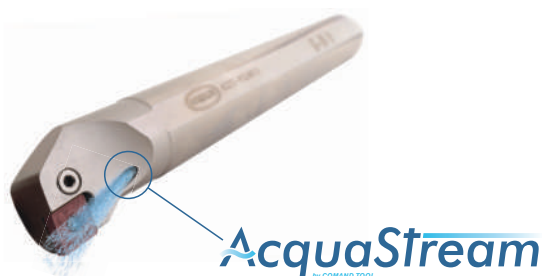

**Compra 1 Utensile
Buy 1 Toolholders**
**10 INSERTI GRATIS
FREE INSERTS**

CT9325



PT8430 **NEW**

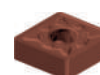

Composizione Set / Set Composition

Cod. PROMO	n° 1 Utensile / Tool	n° 10 Inserti / Inserts	n° 1 Chiave / Key	Prezzo / Price
PRM01-0037	A25R PCLNR 12	CNMG120408CMR CT9325 ●	CBR30	€ 129,00
PRM01-0038	A32S PCLNR 12	CNMG120408CMR CT9325 ●	CBR30	€ 139,00
PRM01-0039	A25R PCLNL 12	CNMG120408CMR CT9325 ●	CBR30	€ 129,00
PRM01-0040	A32S PCLNL 12	CNMG120408CMR CT9325 ●	CBR30	€ 139,00
PRM01-0041	A25R PCLNR 12	CNMG120408CMR PT8430 ●	CBR30	€ 129,00
PRM01-0042	A32S PCLNR 12	CNMG120408CMR PT8430 ●	CBR30	€ 139,00
PRM01-0043	A25R PCLNL 12	CNMG120408CMR PT8430 ●	CBR30	€ 129,00
PRM01-0044	A32S PCLNL 12	CNMG120408CMR PT8430 ●	CBR30	€ 139,00

Tornitura Interna A...SCLCR/L 09

Utensili per Tornitura Interna / Internal Turning Tools



**Compra 1 Utensile
Buy 1 Toolholders**
**10 INSERTI GRATIS
FREE INSERTS**

CT9325



PT8430 **NEW**



Composizione Set / Set Composition

Cod. PROMO	n° 1 Utensile / Tool	n° 10 Inserti / Inserts	n° 1 Chiave / Key	Prezzo / Price
PRM01-0045	A16M SCLCR 09	CCMT09T304CSF CT9325 ●	BTX15	€ 109,00
PRM01-0046	A20Q SCLCR 09	CCMT09T304CSF CT9325 ●	BTX15	€ 119,00
PRM01-0047	A25R SCLCR 09	CCMT09T304CSF CT9325 ●	BTX15	€ 129,00
PRM01-0048	A16M SCLCL 09	CCMT09T304CSF CT9325 ●	BTX15	€ 109,00
PRM01-0049	A20Q SCLCL 09	CCMT09T304CSF CT9325 ●	BTX15	€ 119,00
PRM01-0050	A25R SCLCL 09	CCMT09T304CSF CT9325 ●	BTX15	€ 129,00
PRM01-0051	A16M SCLCR 09	CCMT09T308CSM PT8430 ●	BTX15	€ 109,00
PRM01-0052	A20Q SCLCR 09	CCMT09T308CSM PT8430 ●	BTX15	€ 119,00
PRM01-0053	A25R SCLCR 09	CCMT09T308CSM PT8430 ●	BTX15	€ 129,00
PRM01-0054	A16M SCLCL 09	CCMT09T308CSM PT8430 ●	BTX15	€ 109,00
PRM01-0055	A20Q SCLCL 09	CCMT09T308CSM PT8430 ●	BTX15	€ 119,00
PRM01-0056	A25R SCLCL 09	CCMT09T308CSM PT8430 ●	BTX15	€ 129,00

Tornitura Interna A...SDUCR/L 11

Utensili per Tornitura Interna / Internal Turning Tools



**Compra 1 Utensile
Buy 1 Toolholders**
**10 INSERTI GRATIS
FREE INSERTS**

CT9325



PT8430 **NEW**



Composizione Set / Set Composition

Cod. PROMO	n° 1 Utensile / Tool	n° 10 Inserti / Inserts	n° 1 Chiave / Key	Prezzo / Price
PRM01-0057	A20Q SDUCR 11	DCMT11T304CSF CT9325 ●	BTX15	€ 129,00
PRM01-0058	A25R SDUCR 11	DCMT11T304CSF CT9325 ●	BTX15	€ 139,00
PRM01-0059	A32S SDUCR 11	DCMT11T304CSF CT9325 ●	BTX15	€ 149,00
PRM01-0060	A20Q SDUCL 11	DCMT11T304CSF CT9325 ●	BTX15	€ 129,00
PRM01-0061	A25R SDUCL 11	DCMT11T304CSF CT9325 ●	BTX15	€ 139,00
PRM01-0062	A32S SDUCL 11	DCMT11T304CSF CT9325 ●	BTX15	€ 149,00
PRM01-0063	A20Q SDUCR 11	DCMT11T308CSM PT8430 ●	BTX15	€ 129,00
PRM01-0064	A25R SDUCR 11	DCMT11T308CSM PT8430 ●	BTX15	€ 139,00
PRM01-0065	A32S SDUCR 11	DCMT11T308CSM PT8430 ●	BTX15	€ 149,00
PRM01-0066	A20Q SDUCL 11	DCMT11T308CSM PT8430 ●	BTX15	€ 129,00
PRM01-0067	A25R SDUCL 11	DCMT11T308CSM PT8430 ●	BTX15	€ 139,00
PRM01-0068	A32S SDUCL 11	DCMT11T308CSM PT8430 ●	BTX15	€ 149,00

Tornitura Interna

Set Utensili per Tornitura Interna / Internal Turning Tools Set



NEW

CCMT0602
PT8430



**Compra 1 Set Utensili
Buy 1 Tools Set**
**10 INSERTI GRATIS
FREE INSERTS**

AcquaStream
by COMAND TOOL



NEW

DCMT0702
PT8430



Composizione Set / Set Composition

Cod. PROMO	Cod. Set	Utensili / Tools	n° 10 Inserti / Inserts	Prezzo / Price
PRM01-0069	SETACL0816R	A0608H SCLCR 06	CCMT0602.. PT8430	€ 159,00
		A0810J SCLCR 06		
		A1012K SCLCR 06		
		A1216M SCLCR 06		
PRM01-0070	SETACL0816L	A0608H SCLCL 06	CCMT0602.. PT8430	€ 159,00
		A0810J SCLCL 06		
		A1012K SCLCL 06		
		A1216M SCLCL 06		
PRM01-0071	SETADU1016R	A0810J SDUCR 07	DCMT0702.. PT8430	€ 149,00
		A1012K SDUCR 07		
		A1216M SDUCR 07		
PRM01-0072	SETADU1016L	A0810J SDUCL 07	DCMT0702.. PT8430	€ 149,00
		A1012K SDUCL 07		
		A1216M SDUCL 07		



Filettatura Esterna

External Threading



**Compra 1 Utensile
Buy 1 Toolholders**
**10 INSERTI GRATIS
FREE INSERTS**

PT4320



Composizione Set / Set Composition

Cod. PROMO	n° 1 Utensile / Tool	n° 10 (5x2) Inserti / Inserts	n° 1 Chiave / Key	Prezzo / Price
PRM01-0105	SER 2020K 16	16ER/IR P1,00 PT4320 ●	BTX15	€ 139,00
PRM01-0106	SER 2525M 16	16ER/IR P1,25 PT4320 ●	BTX15	€ 149,00
PRM01-0107	SEL 2020K 16	16ER/IR P1,50 PT4320 ●	BTX15	€ 139,00
PRM01-0108	SEL 2525M 16	16ER/IR P1,75 PT4320 ●	BTX15	€ 149,00

* per gli utensili di **Filettatura Esterna DESTRI** utilizzare inserto **16ER...**
per gli utensili di **Filettatura Esterna SINISTRI** utilizzare inserto **16IR...**

Filettatura Interna

Internal Threading



**Compra 1 Utensile
Buy 1 Toolholders**
**10 INSERTI GRATIS
FREE INSERTS**

PT4320









Composizione Set / Set Composition

Cod. PROMO	n° 1 Utensile / Tool	n° 10 (5x2) Inserti / Inserts	n° 1 Chiave / Key	Prezzo / Price
PRM01-0109	A16M SIR 16	16IR/ER P1,00 PT4320 ●	BTX15	€ 169,00
PRM01-0110	A20Q SIR 16	16IR/ER P1,25 PT4320 ●	BTX15	€ 179,00
PRM01-0111	A16M SIL 16	16IR/ER P1,50 PT4320 ●	BTX15	€ 169,00
PRM01-0112	A20Q SIL 16	16IR/ER P1,75 PT4320 ●	BTX15	€ 179,00

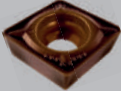
* per gli utensili di **Filettatura Interna DESTRI** utilizzare inserto **16IR...**
per gli utensili di **Filettatura Interna SINISTRI** utilizzare inserto **16ER...**

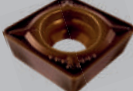
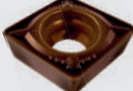

Inserti Tornitura Positivi **NEW**

Positive Turning Inserts

Inserti / Inserts	Codice Inserto / Insert Code	Prezzo per singolo Inserto / Single Insert price	
		Ordine minimo / Minimum order n° 50 pz	Ordine minimo / Minimum order n° 100 pz
	CCMT060204CSM PT8430	€ 4,20	€ 3,80
	CCMT09T304CSM PT8430	€ 4,90	€ 4,20
	CCMT09T308CSM PT8430	€ 4,90	€ 4,20
	CCMT120404CSM PT8430	€ 6,70	€ 6,20
	CCMT120408CSM PT8430	€ 6,70	€ 6,20
	DCMT070204CSM PT8430	€ 5,50	€ 4,90
	DCMT11T304CSM PT8430	€ 5,50	€ 4,90
	DCMT11T308CSM PT8430	€ 5,50	€ 4,90

Inserti Tornitura Negativi

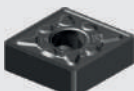
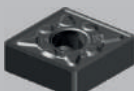
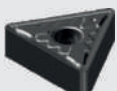
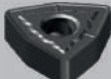
Negative Turning Inserts

Inserti / Inserts	Codice Inserto / Insert Code	Prezzo per singolo Inserto / Single Insert price	
		Ordine minimo / Minimum order n° 50 pz	Ordine minimo / Minimum order n° 100 pz
	CNMG120408CMR CT9325	€ 5,90	€ 5,20
	CNMG120408CX CT2335 (per Inox)	€ 5,90	€ 5,20
	TNMG160408CMR CT9325	€ 5,10	€ 4,40
	WNMG080408CMR CT9325	€ 6,50	€ 5,70
	WNMG080408CX CT2335 (per INOX)	€ 6,50	€ 5,70

Frese per Spallamenti

Frese per Spallamenti a 90° / Shoulder Milling Cutters at 90°

Compra 1 Fresa
Buy 1 Mill

10 INSERTI GRATIS
FREE INSERTS



Composizione Set / Set Composition

Cod. PROMO	Utensile / Tool	n° 10 Inserti / Inserts	Prezzo / Price
PRM02-0001	M30D16	APKT1003PDSR CM9325	€ 125,00
PRM02-0002	M30D20	APKT1003PDSR CM9325	€ 135,00
PRM02-0003	M30D25	APKT1003PDSR CM9325	€ 155,00
PRM02-0004	M32D40	APKT1003PDSR CM9325	€ 190,00
PRM02-0005	M32D50	APKT1003PDSR CM9325	€ 200,00
PRM02-0006	M35D16	APKT1003PDSR CM9325	€ 135,00
PRM02-0007	M35D20	APKT1003PDSR CM9325	€ 145,00
PRM02-0008	M35D25	APKT1003PDSR CM9325	€ 165,00
PRM02-0009	M50D25	APKT1604PDSR CM9325	€ 135,00
PRM02-0010	M50D32	APKT1604PDSR CM9325	€ 145,00
PRM02-0011	M52D40	APKT1604PDSR CM9325	€ 160,00
PRM02-0012	M52D50	APKT1604PDSR CM9325	€ 170,00
PRM02-0013	M52D63	APKT1604PDSR CM9325	€ 180,00
PRM02-0014	M52D80	APKT1604PDSR CM9325	€ 190,00
PRM02-0015	M55D25	APKT1604PDSR CM9325	€ 145,00
PRM02-0016	M55D32	APKT1604PDSR CM9325	€ 165,00



Frese per Spallamenti

Frese per Spallamenti a 90° / Shoulder Milling Cutters at 90°

Compra 1 Fresa
Buy 1 Mill

10 INSERTI GRATIS
FREE INSERTS

**INSERTI / INSERTS
TPKT10**

VANTAGGI / ADVANTAGES

- 3 taglienti elicoidali
- Spoglia assiale super-positiva
- Massima stabilità dell'inserto in fase di lavorazione
- 3 helical cutting edges
- Super-positive axial threshold
- Maximum insert stability during machining

TPKT10
spallamento
retto 90°

TPKT10



PM4325



TPKT10



PM2240



AcquaStream
by COMAND TOOL

Composizione Set / Set Composition

Cod. PROMO	Utensile / Tool	n° 10 Inserti / Inserts	Prezzo / Price
PRM02-0064	M332D40-5	TPKT100408 PM4325 ●	€ 199,00
PRM02-0065	M332D50-6	TPKT100408 PM4325 ●	€ 219,00
PRM02-0066	M332D40-5	TPKT100408 PM2240 ●	€ 199,00
PRM02-0067	M332D50-6	TPKT100408 PM2240 ●	€ 219,00
PRM02-0068	M330D20-2	TPKT100408 PM4325 ●	€ 169,00
PRM02-0069	M330D25-3	TPKT100408 PM4325 ●	€ 179,00
PRM02-0070	M330D32-4	TPKT100408 PM4325 ●	€ 189,00
PRM02-0071	M330D20-2	TPKT100408 PM2240 ●	€ 169,00
PRM02-0072	M330D25-3	TPKT100408 PM2240 ●	€ 179,00
PRM02-0073	M330D32-4	TPKT100408 PM2240 ●	€ 189,00

Frese per Spallamenti

Frese per Spallamenti a 90° / Shoulder Milling Cutters at 90°

Compra 1 Fresa
Buy 1 Mill

10 INSERTI GRATIS
FREE INSERTS

**INSERTI / INSERTS
TPKT15**

VANTAGGI / ADVANTAGES

- 3 taglienti elicoidali
- Spoglia assiale super-positiva
- Massima stabilità dell'inserto in fase di lavorazione
- 3 helical cutting edges
- Super-positive axial threshold
- Maximum insert stability during machining

TPKT15
spallamento
retto 90°

TPKT15



PM4325



TPKT15



PM2240



M342D...

AcquaStream
by COMAND TOOL

Composizione Set / Set Composition

Cod. PROMO	Utensile / Tool	n° 10 Inserti / Inserts	Prezzo / Price
PRM02-0074	M342D50-4	TPKT150508 PM4325 ●	€ 169,00
PRM02-0075	M342D50-5	TPKT150508 PM4325 ●	€ 179,00
PRM02-0076	M342D63-5	TPKT150508 PM4325 ●	€ 179,00
PRM02-0077	M342D63-6	TPKT150508 PM4325 ●	€ 189,00
PRM02-0078	M342D80-6	TPKT150508 PM4325 ●	€ 199,00
PRM02-0079	M342D80-8	TPKT150508 PM4325 ●	€ 219,00
PRM02-0080	M342D50-4	TPKT150508 PM2240 ●	€ 169,00
PRM02-0081	M342D50-5	TPKT150508 PM2240 ●	€ 179,00
PRM02-0082	M342D63-5	TPKT150508 PM2240 ●	€ 179,00
PRM02-0083	M342D63-6	TPKT150508 PM2240 ●	€ 189,00
PRM02-0084	M342D80-6	TPKT150508 PM2240 ●	€ 199,00
PRM02-0085	M342D80-8	TPKT150508 PM2240 ●	€ 219,00

Frese gambo ridotto per Motorizzati

Frese per Portautensile Motorizzati / Milling Cutters for Motorized Toolholders

Compra 1 Fresa
Buy 1 Mill

10 INSERTI GRATIS
FREE INSERTS

**BREVETTATO
PATENTED** **INSERTO / INSERT
XOHT1103**

VANTAGGI / ADVANTAGES

- Insetto completamente rettificato
- Riduzione dello sforzo in fase di lavorazione
- Attacco progettato appositamente per motorizzati
- Completely ground insert
- Reduction of effort during machining
- Shank specially designed for motorized

XOHT1103

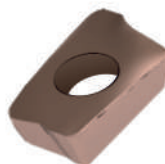

PM4425



esempio di Portautensile Motorizzato
example of Motorized Toolholders



M320D...



M325D...



M327...

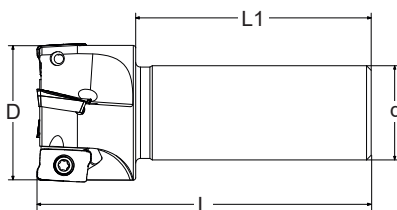

Composizione Set / Set Composition

Cod. PROMO	Utensile / Tool	D	d	Z	L	L1	n° 10 Insetti / Inserts	Prezzo / Price
PRM02-0033	M320D16-12	16	12	2	61	38	XOHT1103 PM4425	€ 140,00
PRM02-0034	M320D20-12	20	12	3	61	38	XOHT1103 PM4425	€ 150,00
PRM02-0035	M320D25-12	25	12	3	61	38	XOHT1103 PM4425	€ 160,00
PRM02-0037	M325D20-16	20	16	3	66	42	XOHT1103 PM4425	€ 140,00
PRM02-0038	M325D25-16	25	16	3	66	42	XOHT1103 PM4425	€ 150,00
PRM02-0039	M325D32-16	32	16	4	66	42	XOHT1103 PM4425	€ 160,00
PRM02-0041	M327D32-20	32	20	4	71	48	XOHT1103 PM4425	€ 160,00
PRM02-0042	M327D40-20	40	20	4	71	48	XOHT1103 PM4425	€ 170,00

Frese per Motorizzati

Frese per Portautensile Motorizzati / Milling Cutters for Motorized Toolholders

INSERTO / INSERT
APKT0602..

Compra 1 Fresa
Buy 1 Mill

10 INSERTI GRATIS
FREE INSERTS

APKT0602

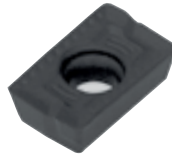

PM4325



esempio di Portautensile Motorizzato
example of Motorized Toolholders

AcquaStream
by COMAND TOOL



M300D10-2



M300D12-3



M300D16-4

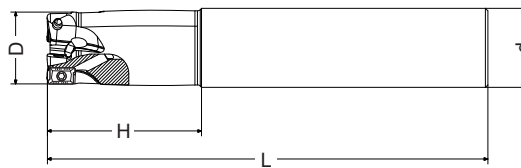

Composizione Set / Set Composition

Cod. PROMO	Utensile / Tool	D	d	Z	L	H	n° 10 Inserti / Inserts	Prezzo / Price
PRM02-0086	M300D10-2	10	10	2	72	16	APKT0602PDSR PM4325	€ 129,00
PRM02-0087	M300D12-3	12	12	3	80	26	APKT0602PDSR PM4325	€ 139,00
PRM02-0088	M300D16-4	16	16	4	90	32	APKT0602PDSR PM4325	€ 149,00

KIT

Composizione Set / Set Composition

Cod. PROMO	Utensili / Tools	n° 10 Inserti / Inserts	Prezzo / Price
PRM02-0089	M300D10-2 + M300D12-3 + M300D16-4	APKT0602PDSR PM4325	€ 259,00



Frese Spianatura - M132

Frese per Spianatura / Milling Cutters

Compra 1 Fresa
Buy 1 Mill

10 INSERTI GRATIS
FREE INSERTS



AcquaStream
by COMAND TOOL

Composizione Set / Set Composition

Cod. PROMO	Utensile / Tool	n° 10 Inserti / Inserts	Prezzo / Price
PRM02-0043	M132D40	SEKT13T3AGSN PM4325	€ 200,00
PRM02-0044	M132D50	SEKT13T3AGSN PM4325	€ 210,00
PRM02-0045	M132D63	SEKT13T3AGSN PM4325	€ 220,00
PRM02-0046	M132D80	SEKT13T3AGSN PM4325	€ 230,00

Frese Spianatura - M232

Frese per Spianatura / Milling Cutters

Compra 1 Fresa
Buy 1 Mill

10 INSERTI GRATIS
FREE INSERTS



AcquaStream
by COMAND TOOL

Composizione Set / Set Composition

Cod. PROMO	Utensile / Tool	n° 10 Inserti / Inserts	Prezzo / Price
PRM02-0051	M232D50	SNEX1206ANN PM4325	€ 230,00
PRM02-0052	M232D63	SNEX1206ANN PM4325	€ 250,00
PRM02-0053	M232D80	SNEX1206ANN PM4325	€ 260,00

Frese Graduali

Frese per Smussare e Svasare con Angolo Regolabile / Chamfering and Flaring Milling Cutters with Adjustable Angle



Compra 1 Fresa
Buy 1 Mill
10 INSERTI GRATIS
FREE INSERTS

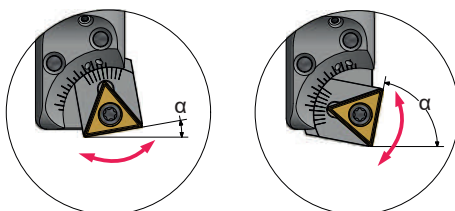

α = angolo regolabile / adjustable corner

TCMT110208
TCMT16T308
PT8430

NEW



P M K S
■ ■ ■ ■

movimento graduale da 5° a 95°
gradual movement from 5° to 95°

Composizione Set / Set Composition

Cod. PROMO	Utensile / Tool	n° 10 Insetti / Inserts	Prezzo / Price
PRM02-0054	SRT0520-20	TCMT110208CSM PT8430	€ 189,00
PRM02-0055	SRT0523-25	TCMT16T308CSM PT8430	€ 199,00

Frese per Cave a "T"

Frese Slot / Slot Mills

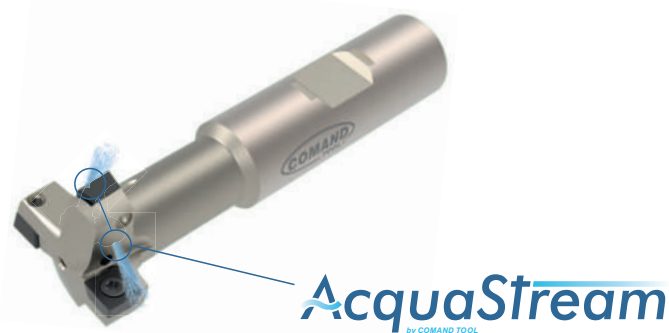

Compra 1 Utensile
Buy 1 Toolholders
10 INSERTI GRATIS
FREE INSERTS

XPMT...
PM4325



P M K S
■ ■ ■ ■

Composizione Set / Set Composition

Cod. PROMO	n° 1 Utensile / Tool	n° 10 Insetti / Inserts	Prezzo / Price
PRM02-0056	SLOT-21-09	XPMT060304 PM4325	€ 225,00
PRM02-0057	SLOT-25-11	XPMT060304 PM4325	€ 245,00
PRM02-0058	SLOT-28-12	XPMT060304 PM4325	€ 255,00
PRM02-0059	SLOT-32-14	XPMT09T308 PM4325	€ 285,00
PRM02-0060	SLOT-36-16	XPMT09T308 PM4325	€ 295,00
PRM02-0061	SLOT-40-17	XPMT09T308 PM4325	€ 305,00
PRM02-0062	SLOT-45-20	XPMT120408 PM4325	€ 315,00
PRM02-0063	SLOT-50-22	XPMT120408 PM4325	€ 325,00

Frese per Smussi a Trazione 45°

45° back Chamfering Mills

AcquaStream
by COMAND TOOL



Compra 1 Fresa
Buy 1 Mill
10 INSERTI GRATIS
FREE INSERTS

CCMT060204CSM
CCMT09T308CSM

PT8430

NEW



P M K S
■ ■ ■ ■

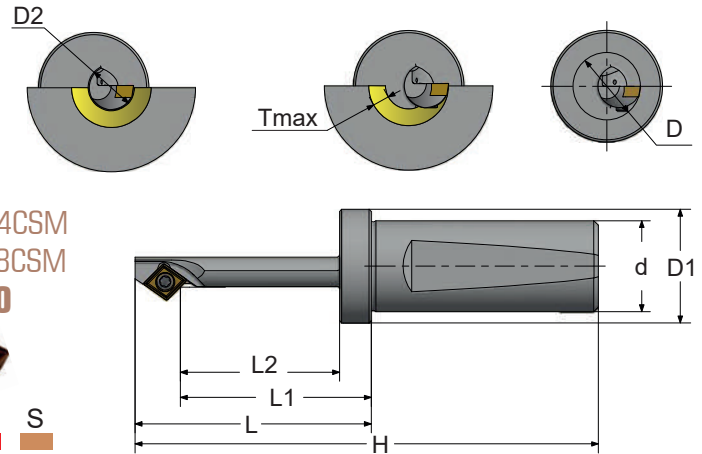

Set Composition

Cod. PROMO	Articolo / Item	Ins.	D	D2	D1	d	Tmax	E	H	L	L1	L2	Prezzo / Price
PRM03-0001	FB45D150-06	CC..06	15	10	25	20	2,5	2,8	100	50	42	35	€ 185,00
PRM03-0002	FB45D200-06	CC..06	20	14	25	20	3	3,2	105	55	47	40	€ 185,00
PRM03-0003	FB45D230-06	CC..06	23	17	25	20	3	3,2	115	65	57	50	€ 185,00
PRM03-0004	FB45D270-09	CC..09	27	21	25	20	3	3,4	138	88	77	70	€ 185,00
PRM03-0005	FB45D310-09	CC..09	31	24	25	20	3,5	3,9	148	98	87	80	€ 185,00

Istruzioni per l'utilizzo Frese per Smussi a Trazione 45°

Instruction for use 45° back Chamfering Mills

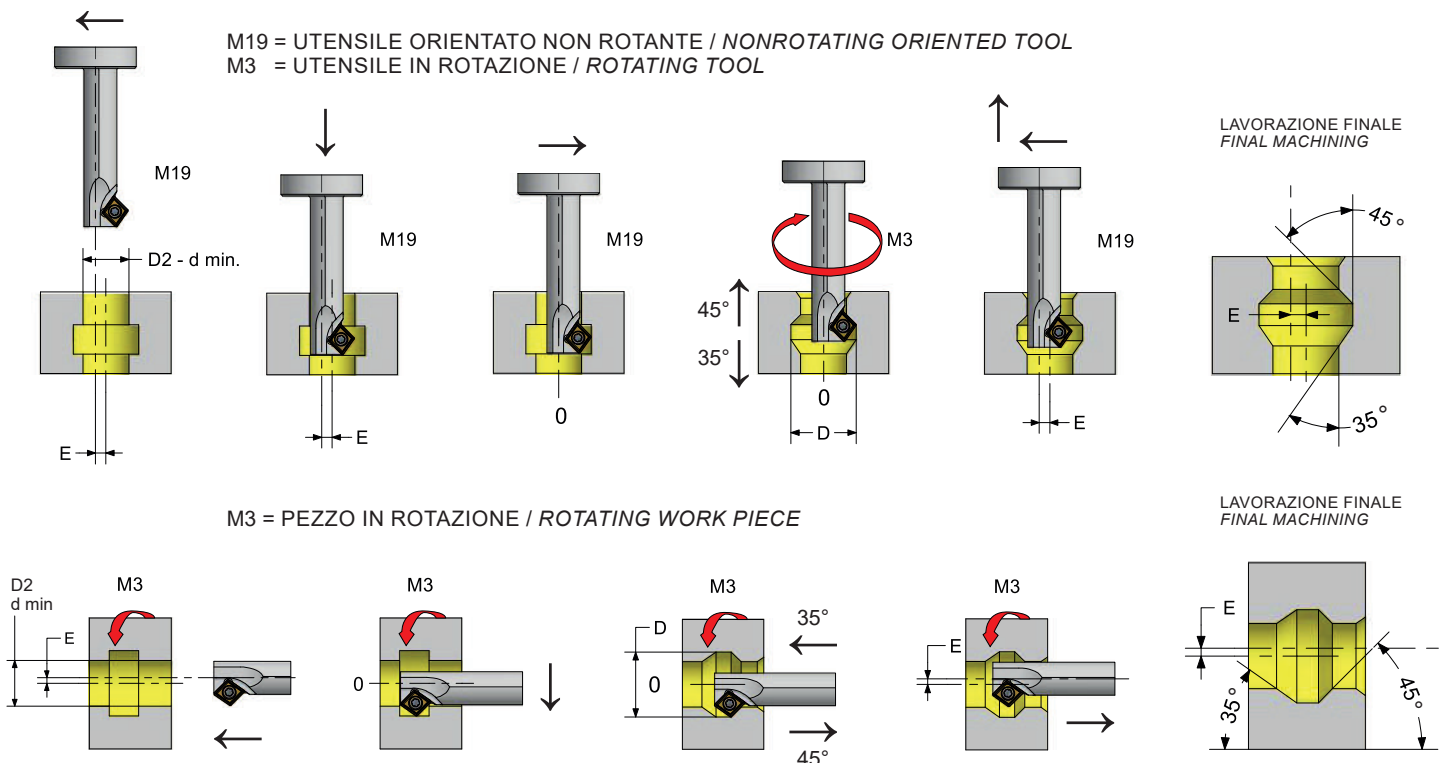

Frese per Lamature a Trazione 90°

90° back Spot-Facing Mills

AcquaStream
by COMAND TOOL



Compra 1 Fresa
Buy 1 Mill
10 INSERTI GRATIS
FREE INSERTS

CCMT060204CSM
CCMT09T308CSM

PT8430

NEW



P M K S
■ ■ ■ ■

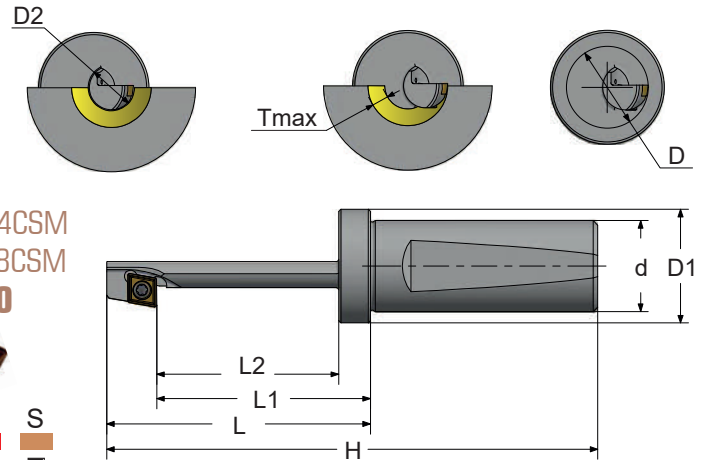

Set Composition

Cod. PROMO	Articolo / Item	Ins.	D	D2	D1	d	Tmax	E	H	L	L1	L2	Prezzo / Price
PRM03-0006	FB90D180-06	CC..06	18	10,5	25	20	3,75	4	108	58	47	40	€ 185,00
PRM03-0007	FB90D200-06	CC..06	20	13	25	20	3,5	3,75	113	63	52	45	€ 185,00
PRM03-0008	FB90D240-06	CC..06	24	15	25	20	4,5	4,75	118	68	57	50	€ 185,00
PRM03-0009	FB90D260-06	CC..06	26	17	25	20	4,5	5	128	78	67	60	€ 185,00
PRM03-0010	FB90D300-06	CC..06	30	19	25	20	5,5	6	133	83	72	65	€ 185,00
PRM03-0011	FB90D330-09	CC..09	33	21	25	20	6	6,6	148	98	82	75	€ 185,00

Istruzioni per l'utilizzo Frese per Lamatura a Trazione 90°

Instruction for use 90° back Spot-Facing Mills

M19 = UTENSILE ORIENTATO NON ROTANTE / NONROTATING ORIENTED TOOL
M3 = UTENSILE IN ROTAZIONE / ROTATING TOOL

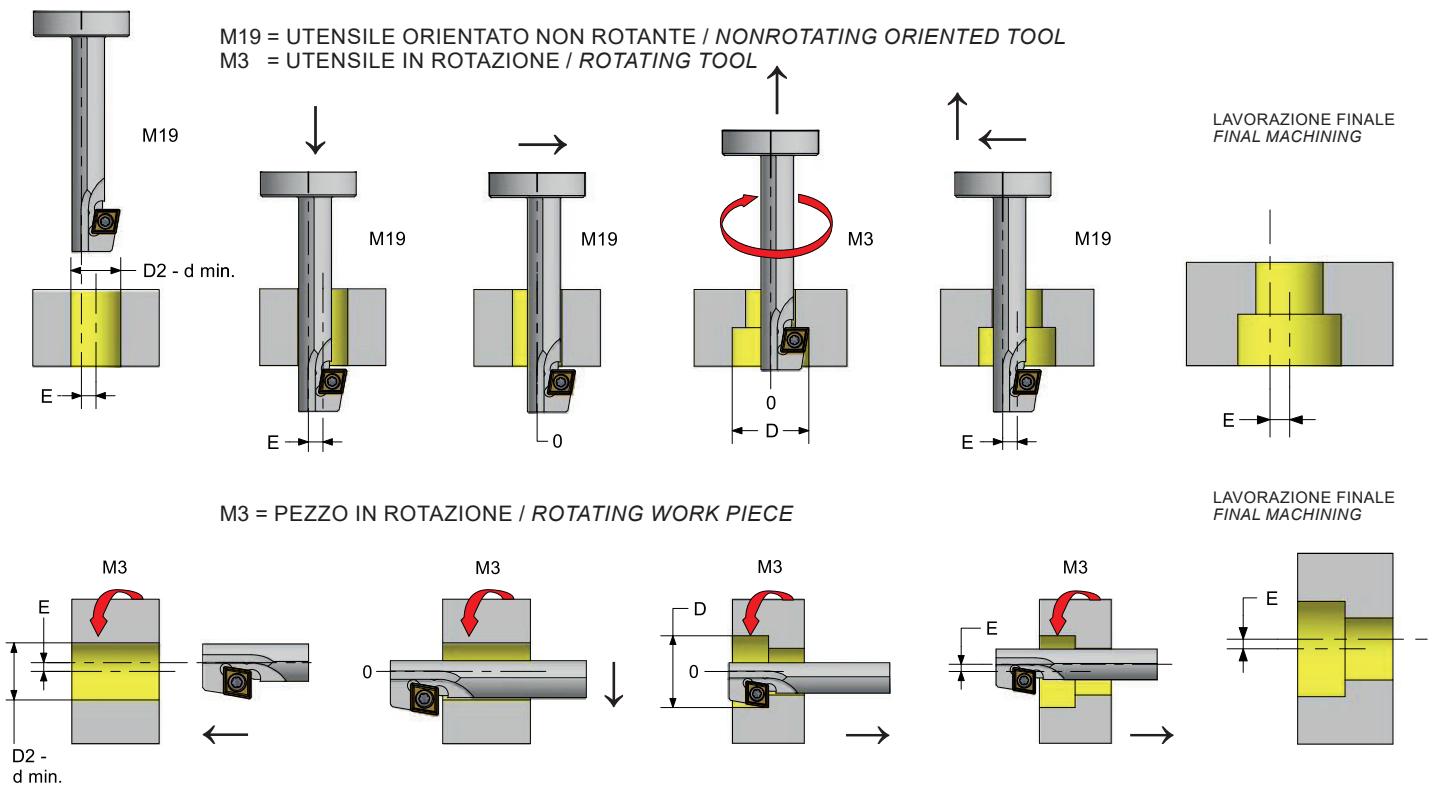

Frese in Metallo Duro - E4H

Frese in Metallo Duro per Materiali Speciali / Carbide end Mills for Special Materials



RICOPERTURA
XC70

**IDEALI PER
MULTIMAT**
**IDEAL FOR
MULTIMAT**



**Microspigolo di protezione
per una maggiore durata**
**Protective micro-edge
for extra durability**

**Speciale angolo di taglio
per ottimizzare la fresatura**
**Special cutting edge
for milling optimization**

Composizione Set / Set Composition

Cod. PROMO	Articolo / Item	Diametro / Diameter	Quantità / Quantity	Prezzo / Price
PRM11-0102	E4H 080 L16 XC70	Ø 8	2 pz	€ 75,00
PRM11-0103	E4H 100 L20 XC70	Ø 10	2 pz	€ 105,00
PRM11-0104	E4H 120 L24 XC70	Ø 12	2 pz	€ 125,00
PRM11-0105	E4H 160 L32 XC70	Ø 16	2 pz	€ 205,00
PRM11-0106	E4H 200 L40 XC70	Ø 20	2 pz	€ 325,00
PRM11-0107	SET-E4H	da Ø 8 a Ø 12	3 pz	€ 145,00

Frese in Metallo Duro - E4K

Frese in Metallo Duro per Materiali Speciali / Carbide end Mills for Special Materials

**COLLARE RIBASSATO
REDUCED COLLAR**



RICOPERTURA
XC70

**IDEALI PER
SUPERLEGHE**
**IDEAL FOR
SUPERALLOYS**



**Taglienti a divisione irregolare
per ottimizzare la fresatura**
**Irregular division flutes
for milling optimization**

Composizione Set / Set Composition

Cod. PROMO	Articolo / Item	Diametro / Diameter	Quantità / Quantity	Prezzo / Price
PRM11-0011	E4K 060 L12 XC70	Ø 6	2 pz	€ 55,00
PRM11-0012	E4K 080 L16 XC70	Ø 8	2 pz	€ 75,00
PRM11-0013	E4K 100 L20 XC70	Ø 10	2 pz	€ 105,00
PRM11-0014	E4K 120 L24 XC70	Ø 12	2 pz	€ 125,00
PRM11-0015	SET-E4K	da Ø 6 a Ø 12	4 pz	€ 165,00

Frese in Metallo Duro - E3X

Frese in Metallo Duro per Superleghe / Carbide end Mills for Superalloys



**IDEALI PER
SUPERLEGHE**
**IDEAL FOR
SUPERALLOYS**



RICOPERTURA
XC70



10%
Cobalto

Helix
Angle
45°

Conformazione dell'elica
perfezionata per una efficace
evacuazione del truciolo
Refined helix shape for a
better chipbreaker evacuation

Composizione Set / Set Composition

Cod. PROMO	Articolo / Item	Diametro / Diameter	Quantità / Quantity	Prezzo / Price
PRM11-0001	E3X 060 L15 XC70	Ø 6	2 pz	€ 48,00
PRM11-0002	E3X 080 L20 XC70	Ø 8	2 pz	€ 68,00
PRM11-0003	E3X 100 L25 XC70	Ø 10	2 pz	€ 98,00
PRM11-0004	E3X 120 L30 XC70	Ø 12	2 pz	€ 128,00
PRM11-0005	SET-E3X	da Ø 6 a Ø 12	4 pz	€ 158,00

Frese in Metallo Duro - E4X

Frese in Metallo Duro per Superleghe / Carbide end Mills for Superalloys



**IDEALI PER
SUPERLEGHE**
**IDEAL FOR
SUPERALLOYS**



RICOPERTURA
XC70



10%
Cobalto

Helix
Angle
45°

Conformazione dell'elica
perfezionata per una efficace
evacuazione del truciolo
Refined helix shape for a
better chipbreaker evacuation

Composizione Set / Set Composition

Cod. PROMO	Articolo / Item	Diametro / Diameter	Quantità / Quantity	Prezzo / Price
PRM11-0006	E4X 060 L15 XC70	Ø 6	2 pz	€ 48,00
PRM11-0007	E4X 080 L20 XC70	Ø 8	2 pz	€ 68,00
PRM11-0008	E4X 100 L25 XC70	Ø 10	2 pz	€ 98,00
PRM11-0009	E4X 120 L30 XC70	Ø 12	2 pz	€ 128,00
PRM11-0010	SET-E4X	da Ø 6 a Ø 12	4 pz	€ 158,00

Frese in Metallo Duro - Serie Convenzionale

Frese in Metallo Duro / Carbide end Mills

RICOPERTURA
XC50

E 2A - 2 Taglienti

E 3A - 3 Taglienti

E4A - 4 Taglienti



3
PZ / PCS

5
PZ / PCS

10
PZ / PCS

Cod. Fresa / Mill	Cod. PROMO	Prezzo Price	Q.tà Qty	Cod. PROMO	Prezzo Price	Q.tà Qty	Cod. PROMO	Prezzo Price	Q.tà Qty
E2A 030 L09	PRM11-0021	€ 35,00	3	PRM11-0048	€ 53,00	5	PRM11-0075	€ 88,00	10
E3A 030 L09	PRM11-0022	€ 35,00	3	PRM11-0049	€ 53,00	5	PRM11-0076	€ 88,00	10
E4A 030 L09	PRM11-0023	€ 35,00	3	PRM11-0050	€ 53,00	5	PRM11-0077	€ 88,00	10
E2A 040 L12	PRM11-0024	€ 39,00	3	PRM11-0051	€ 59,00	5	PRM11-0078	€ 105,00	10
E3A 040 L12	PRM11-0025	€ 39,00	3	PRM11-0052	€ 59,00	5	PRM11-0079	€ 105,00	10
E4A 040 L12	PRM11-0026	€ 39,00	3	PRM11-0053	€ 59,00	5	PRM11-0080	€ 105,00	10
E2A 050 L15	PRM11-0027	€ 43,00	3	PRM11-0054	€ 65,00	5	PRM11-0081	€ 112,00	10
E3A 050 L15	PRM11-0028	€ 43,00	3	PRM11-0055	€ 65,00	5	PRM11-0082	€ 112,00	10
E4A 050 L15	PRM11-0029	€ 43,00	3	PRM11-0056	€ 65,00	5	PRM11-0083	€ 112,00	10
E2A 060 L18	PRM11-0030	€ 46,00	3	PRM11-0057	€ 70,00	5	PRM11-0084	€ 118,00	10
E3A 060 L18	PRM11-0031	€ 46,00	3	PRM11-0058	€ 70,00	5	PRM11-0085	€ 118,00	10
E4A 060 L18	PRM11-0032	€ 46,00	3	PRM11-0059	€ 70,00	5	PRM11-0086	€ 118,00	10
E2A 080 L24	PRM11-0033	€ 69,00	3	PRM11-0060	€ 105,00	5	PRM11-0087	€ 195,00	10
E3A 080 L24	PRM11-0034	€ 69,00	3	PRM11-0061	€ 105,00	5	PRM11-0088	€ 195,00	10
E4A 080 L24	PRM11-0035	€ 69,00	3	PRM11-0062	€ 105,00	5	PRM11-0089	€ 195,00	10
E2A 100 L20	PRM11-0036	€ 105,00	3	PRM11-0063	€ 165,00	5	PRM11-0090	€ 285,00	10
E3A 100 L20	PRM11-0037	€ 105,00	3	PRM11-0064	€ 165,00	5	PRM11-0091	€ 285,00	10
E4A 100 L20	PRM11-0038	€ 105,00	3	PRM11-0065	€ 165,00	5	PRM11-0092	€ 285,00	10
E2A 100 L30	PRM11-0039	€ 117,00	3	PRM11-0066	€ 185,00	5	PRM11-0093	€ 300,00	10
E3A 100 L30	PRM11-0040	€ 117,00	3	PRM11-0067	€ 185,00	5	PRM11-0094	€ 300,00	10
E4A 100 L30	PRM11-0041	€ 117,00	3	PRM11-0068	€ 185,00	5	PRM11-0095	€ 300,00	10
E2A 120 L24	PRM11-0042	€ 145,00	3	PRM11-0069	€ 230,00	5	PRM11-0096	€ 390,00	10
E3A 120 L24	PRM11-0043	€ 145,00	3	PRM11-0070	€ 230,00	5	PRM11-0097	€ 390,00	10
E4A 120 L24	PRM11-0044	€ 145,00	3	PRM11-0071	€ 230,00	5	PRM11-0098	€ 390,00	10
E2A 120 L36	PRM11-0045	€ 155,00	3	PRM11-0072	€ 250,00	5	PRM11-0099	€ 420,00	10
E3A 120 L36	PRM11-0046	€ 155,00	3	PRM11-0073	€ 250,00	5	PRM11-0100	€ 420,00	10
E4A 120 L36	PRM11-0047	€ 155,00	3	PRM11-0074	€ 250,00	5	PRM11-0101	€ 420,00	10

Inserti Fresatura

Milling Inserts

Inserti / Inserts	Codice Inserto / Insert Code	Prezzo per singolo Inserto / Single Insert price	
		Ordine minimo / Minimum order n° 50 pz	Ordine minimo / Minimum order n° 100 pz
	TPKT100408 PM4325	€ 7,80	€ 7,30
	TPKT100408 PM2240	€ 7,80	€ 7,30
	TPKT150508 PM4325	€ 8,40	€ 7,80
	TPKT150508 PM2240	€ 8,40	€ 7,80
	APKT0602PDSR PM4325	€ 6,20	€ 5,50
	APKT1003PDSR PM8140	€ 5,20	€ 4,40
	APKT1003PDSR CM9325	€ 5,20	€ 4,40
	APKT1604PDSR PM8140	€ 5,70	€ 4,90
	APKT1604PDSR CM9325	€ 5,70	€ 4,90
	SEKT13T3AGSN PM4325	€ 6,90	€ 6,30
	SNMX1206ANN PM4325	€ 6,90	€ 6,30



Punte per Foratura 3xD - LCKX05

Punte ad Inserto 3xD / Insert Indexable Drill 3xD



**Compra 1 Utensile
Buy 1 Toolholders**
**10 INSERTI GRATIS
FREE INSERTS**

LCKX05
PD4135



Composizione Set / Set Composition

Cod. PROMO	Diametro / Diameter	n° 1 Utensile / Tool	n° 10 Inserti / Inserts	Prezzo / Price
PRM07-0001	Ø 12,0	FD03D120	LCKX05 PD4135	€ 160,00
PRM07-0002	Ø 12,5	FD03D125	LCKX05 PD4135	€ 160,00
PRM07-0003	Ø 13,0	FD03D130	LCKX05 PD4135	€ 160,00
PRM07-0004	Ø 13,5	FD03D135	LCKX05 PD4135	€ 160,00
PRM07-0005	Ø 14,0	FD03D140	LCKX05 PD4135	€ 160,00
PRM07-0006	Ø 14,5	FD03D145	LCKX05 PD4135	€ 160,00
PRM07-0007	Ø 15,0	FD03D150	LCKX05 PD4135	€ 160,00
PRM07-0008	Ø 15,5	FD03D155	LCKX05 PD4135	€ 160,00
PRM07-0009	Ø 16,0	FD03D160	LCKX05 PD4135	€ 160,00
PRM07-0010	Ø 16,5	FD03D165	LCKX05 PD4135	€ 160,00
PRM07-0011	Ø 17,0	FD03D170	LCKX05 PD4135	€ 160,00

Punte per Foratura 3xD - LCKX07

Punte ad Inserto 3xD / Insert Indexable Drill 3xD

LCKX07
PD4135



PRM07-0012	Ø 17,5	FD03D175	LCKX07 PD4135	€ 170,00
PRM07-0013	Ø 18,0	FD03D180	LCKX07 PD4135	€ 170,00
PRM07-0014	Ø 18,5	FD03D185	LCKX07 PD4135	€ 170,00
PRM07-0015	Ø 19,0	FD03D190	LCKX07 PD4135	€ 170,00
PRM07-0016	Ø 19,5	FD03D195	LCKX07 PD4135	€ 170,00
PRM07-0017	Ø 20,0	FD03D200	LCKX07 PD4135	€ 170,00
PRM07-0018	Ø 20,5	FD03D205	LCKX07 PD4135	€ 170,00
PRM07-0019	Ø 21,0	FD03D210	LCKX07 PD4135	€ 170,00
PRM07-0020	Ø 21,5	FD03D215	LCKX07 PD4135	€ 170,00
PRM07-0021	Ø 22,0	FD03D220	LCKX07 PD4135	€ 170,00
PRM07-0022	Ø 22,5	FD03D225	LCKX07 PD4135	€ 170,00
PRM07-0023	Ø 23,0	FD03D230	LCKX07 PD4135	€ 170,00
PRM07-0024	Ø 23,5	FD03D235	LCKX07 PD4135	€ 170,00
PRM07-0025	Ø 24,0	FD03D240	LCKX07 PD4135	€ 170,00
PRM07-0026	Ø 24,5	FD03D245	LCKX07 PD4135	€ 170,00
PRM07-0027	Ø 25,0	FD03D250	LCKX07 PD4135	€ 170,00
PRM07-0028	Ø 25,5	FD03D255	LCKX07 PD4135	€ 170,00
PRM07-0029	Ø 26,0	FD03D260	LCKX07 PD4135	€ 170,00

Punte per Foratura 3xD - WCMX05/06/08

Punte ad Inserto 3xD / Insert Indexable Drill 3xD



AcquaStream
by COMAND TOOL

**Compra 1 Utensile
Buy 1 Toolholders
10 INSERTI GRATIS
FREE INSERTS**

WCMX...
CT4125



P M K S
■ ■ ■ ■

Composizione Set / Set Composition

Cod. PROMO	Diametro / Diameter	n° 1 Utensile / Tool	n° 10 Inserti / Inserts	Prezzo / Price
PRM07-0030	Ø 27,0	FD03D270	WCMX05 CT4125	€ 220,00
PRM07-0031	Ø 28,0	FD03D280	WCMX05 CT4125	€ 220,00
PRM07-0032	Ø 29,0	FD03D290	WCMX05 CT4125	€ 220,00
PRM07-0033	Ø 30,0	FD03D300	WCMX05 CT4125	€ 220,00
PRM07-0034	Ø 31,0	FD03D310	WCMX05 CT4125	€ 220,00
PRM07-0035	Ø 32,0	FD03D320	WCMX06 CT4125	€ 240,00
PRM07-0036	Ø 33,0	FD03D330	WCMX06 CT4125	€ 240,00
PRM07-0037	Ø 34,0	FD03D340	WCMX06 CT4125	€ 240,00
PRM07-0038	Ø 35,0	FD03D350	WCMX06 CT4125	€ 240,00
PRM07-0039	Ø 36,0	FD03D360	WCMX06 CT4125	€ 240,00
PRM07-0040	Ø 37,0	FD03D370	WCMX06 CT4125	€ 240,00
PRM07-0041	Ø 38,0	FD03D380	WCMX06 CT4125	€ 240,00
PRM07-0042	Ø 39,0	FD03D390	WCMX06 CT4125	€ 240,00
PRM07-0043	Ø 40,0	FD03D400	WCMX06 CT4125	€ 240,00
PRM07-0044	Ø 41,0	FD03D410	WCMX08 CT4125	€ 260,00
PRM07-0045	Ø 42,0	FD03D420	WCMX08 CT4125	€ 260,00
PRM07-0046	Ø 43,0	FD03D430	WCMX08 CT4125	€ 260,00
PRM07-0047	Ø 44,0	FD03D440	WCMX08 CT4125	€ 260,00
PRM07-0048	Ø 45,0	FD03D450	WCMX08 CT4125	€ 260,00
PRM07-0049	Ø 46,0	FD03D460	WCMX08 CT4125	€ 260,00
PRM07-0050	Ø 47,0	FD03D470	WCMX08 CT4125	€ 260,00
PRM07-0051	Ø 48,0	FD03D480	WCMX08 CT4125	€ 260,00
PRM07-0052	Ø 49,0	FD03D490	WCMX08 CT4125	€ 260,00
PRM07-0053	Ø 50,0	FD03D500	WCMX08 CT4125	€ 260,00
PRM07-0054	Ø 51,0	FD03D510	WCMX08 CT4125	€ 260,00
PRM07-0055	Ø 52,0	FD03D520	WCMX08 CT4125	€ 260,00
PRM07-0056	Ø 53,0	FD03D530	WCMX08 CT4125	€ 260,00
PRM07-0057	Ø 54,0	FD03D540	WCMX08 CT4125	€ 260,00
PRM07-0058	Ø 55,0	FD03D550	WCMX08 CT4125	€ 260,00
PRM07-0059	Ø 56,0	FD03D560	WCMX08 CT4125	€ 260,00
PRM07-0060	Ø 57,0	FD03D570	WCMX08 CT4125	€ 260,00
PRM07-0061	Ø 58,0	FD03D580	WCMX08 CT4125	€ 260,00

Punte per Foratura 4xD - LCKX05

Punte ad Inserto 4xD / Insert Indexable Drill 4xD



AcquaStream
by COMAND TOOL

**Compra 1 Utensile
Buy 1 Toolholders**
**10 INSERTI GRATIS
FREE INSERTS**

LCKX05
PD4325



P M K S
■ ■ ■ ■

Composizione Set / Set Composition

Cod. PROMO	Diametro / Diameter	n° 1 Utensile / Tool	n° 10 Inserti / Inserts	Prezzo / Price
PRM07-0062	Ø 13,0	FD04D130	LCKX05 PD4325	€ 190,00
PRM07-0063	Ø 13,5	FD04D135	LCKX05 PD4325	€ 190,00
PRM07-0064	Ø 14,0	FD04D140	LCKX05 PD4325	€ 190,00
PRM07-0065	Ø 14,5	FD04D145	LCKX05 PD4325	€ 190,00
PRM07-0066	Ø 15,0	FD04D150	LCKX05 PD4325	€ 190,00
PRM07-0067	Ø 15,5	FD04D155	LCKX05 PD4325	€ 190,00
PRM07-0068	Ø 16,0	FD04D160	LCKX05 PD4325	€ 190,00
PRM07-0069	Ø 16,5	FD04D165	LCKX05 PD4325	€ 190,00
PRM07-0070	Ø 17,0	FD04D170	LCKX05 PD4325	€ 190,00

Punte per Foratura 4xD - LCKX07

Punte ad Inserto 4xD / Insert Indexable Drill 4xD



AcquaStream
by COMAND TOOL

**Compra 1 Utensile
Buy 1 Toolholders**
**10 INSERTI GRATIS
FREE INSERTS**

LCKX07
PD4325



P M K S
■ ■ ■ ■

Composizione Set / Set Composition

Cod. PROMO	Diametro / Diameter	n° 1 Utensile / Tool	n° 10 Inserti / Inserts	Prezzo / Price
PRM07-0071	Ø 17,5	FD04D175	LCKX07 PD4325	€ 200,00
PRM07-0072	Ø 18,0	FD04D180	LCKX07 PD4325	€ 200,00
PRM07-0073	Ø 18,5	FD04D185	LCKX07 PD4325	€ 200,00
PRM07-0074	Ø 19,0	FD04D190	LCKX07 PD4325	€ 200,00
PRM07-0075	Ø 19,5	FD04D195	LCKX07 PD4325	€ 200,00
PRM07-0076	Ø 20,0	FD04D200	LCKX07 PD4325	€ 200,00
PRM07-0077	Ø 21,0	FD04D210	LCKX07 PD4325	€ 200,00
PRM07-0078	Ø 22,0	FD04D220	LCKX07 PD4325	€ 200,00
PRM07-0079	Ø 23,0	FD04D230	LCKX07 PD4325	€ 200,00
PRM07-0080	Ø 24,0	FD04D240	LCKX07 PD4325	€ 200,00
PRM07-0081	Ø 25,0	FD04D250	LCKX07 PD4325	€ 200,00

Punte per Foratura 4xD - LCKX11

Punte ad Inserto 4xD / Insert Indexable Drill 4xD



AcquaStream
by COMAND TOOL

Compra 1 Utensile
Buy 1 Toolholders
10 INSERTI GRATIS
FREE INSERTS

LCKX11
PD4325

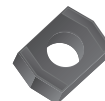

P M K S
■ ■ ■ ■

Composizione Set / Set Composition

Cod. PROMO	Diametro / Diameter	n° 1 Utensile / Tool	n° 10 Inserti / Inserts	Prezzo / Price
PRM07-0082	Ø 26,0	FD04D260-LC	LCKX11 PD4325	€ 230,00
PRM07-0083	Ø 27,0	FD04D270-LC	LCKX11 PD4325	€ 230,00
PRM07-0084	Ø 28,0	FD04D280-LC	LCKX11 PD4325	€ 230,00
PRM07-0085	Ø 29,0	FD04D290-LC	LCKX11 PD4325	€ 230,00
PRM07-0086	Ø 30,0	FD04D300-LC	LCKX11 PD4325	€ 230,00
PRM07-0087	Ø 31,0	FD04D310-LC	LCKX11 PD4325	€ 230,00
PRM07-0088	Ø 32,0	FD04D320-LC	LCKX11 PD4325	€ 230,00
PRM07-0089	Ø 33,0	FD04D330-LC	LCKX11 PD4325	€ 230,00
PRM07-0090	Ø 34,0	FD04D340-LC	LCKX11 PD4325	€ 230,00
PRM07-0091	Ø 35,0	FD04D350-LC	LCKX11 PD4325	€ 230,00
PRM07-0092	Ø 36,0	FD04D360-LC	LCKX11 PD4325	€ 230,00
PRM07-0093	Ø 37,0	FD04D370-LC	LCKX11 PD4325	€ 230,00
PRM07-0094	Ø 38,0	FD04D380-LC	LCKX11 PD4325	€ 230,00
PRM07-0095	Ø 39,0	FD04D390-LC	LCKX11 PD4325	€ 230,00
PRM07-0096	Ø 40,0	FD04D400-LC	LCKX11 PD4325	€ 230,00

Lamatori SB825

Set Frese per Lamatura / Spot Facing Boring Bar

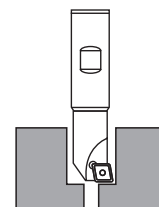

Composizione Set / Set Composition

Cod. PROMO	Articolo / Item	n° 8 Utensili / Tools	NO Inserti / Inserts	Prezzo / Price
PRM07-0097	SET-SB825	SB08M04 - SB09M05 - SB11M06 - SB14-M08 SB17M10 - SB19M12 - SB22M14 - SB25-M16	-	€ 310,00
Cod. PROMO	Articolo / Item	n° 8 Utensili / Tools	n° 30 Inserti / Inserts	Prezzo / Price
PRM07-0098	SET-SB825-i	SB08M04 - SB09M05 - SB11M06 - SB14-M08 SB17M10 - SB19M12 - SB22M14 - SB25-M16	EP05.. (10 pz) EC06.. (10 pz) EC08.. (10 pz)	€ 440,00

* il set include 2 Chiavi Torx / set includes 2 Torx Key (CTX06 - CTX08)

R.D.S. Radial Drilling Setter

DIAMETRO REGOLABILE
ADJUSTABLE DIAMETER

Mandrino per Foratura Multidiametro / Holder for Multidiameter Drilling



DIN 69871



MAS 403 BT



HSK63 DIN69893



DIN ISO 26623-1

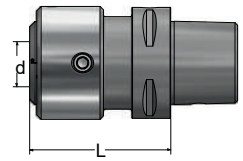
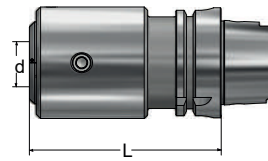
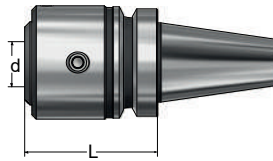
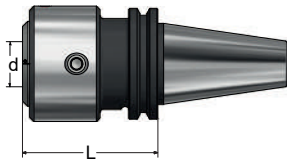

Tutti gli R.D.S. sono provvisti di / All R.D.S. are provided with **AcquaStream**

Composizione Set / Set Composition

Cod. PROMO	Articolo / Item	Tipo Cono / Cone Type	d	L	Q.tà / Q.ty	Prezzo / Price
PRM04-0001	RDS K40-20 075	ISO 40 DIN 69871	20	75	1	€ 330,00
PRM04-0002	RDS K40-25 075	ISO 40 DIN 69871	25	75	1	€ 330,00
PRM04-0003	RDS K40-32 100	ISO 40 DIN 69871	32	100	1	€ 330,00
PRM04-0013	RDS K50-20 075	ISO 50 DIN 69871	20	75	1	€ 360,00
PRM04-0014	RDS K50-25 075	ISO 50 DIN 69871	25	75	1	€ 360,00
PRM04-0004	RDS K50-32 075	ISO 50 DIN 69871	32	75	1	€ 360,00
PRM04-0005	RDS B40-20 075	MAS 403 BT40	20	75	1	€ 330,00
PRM04-0006	RDS B40-25 075	MAS 403 BT40	25	75	1	€ 330,00
PRM04-0007	RDS B40-32 100	MAS 403 BT40	32	100	1	€ 330,00
PRM04-0015	RDS B50-20 075	MAS 403 BT50	20	75	1	€ 360,00
PRM04-0016	RDS B50-25 075	MAS 403 BT50	25	75	1	€ 360,00
PRM04-0008	RDS B50-32 075	MAS 403 BT50	32	75	1	€ 360,00
PRM04-0009	RDS H63-20 105	HSK63 DIN69893 A	20	105	1	€ 340,00
PRM04-0010	RDS H63-25 105	HSK63 DIN69893 A	25	105	1	€ 340,00
PRM04-0017	RDS H63-32 120	HSK63 DIN69893 A	32	120	1	€ 340,00
PRM04-0011	RDS C06-20 080	DIN ISO 26623-1 (C06)	20	80	1	€ 350,00
PRM04-0012	RDS C06-25 080	DIN ISO 26623-1 (C06)	25	80	1	€ 350,00
PRM04-0018	RDS C06-32 090	DIN ISO 26623-1 (C06)	32	90	1	€ 350,00

Fissaggio corretto della Punta su R.D.S.

Correct drill fixing on R.D.S.

Il piano dell'attacco della punta per il fissaggio deve sempre essere parallelo alla sede dell'inserto esterno.
The milled surface on the drill shank must be parallel to the external insert pocket.

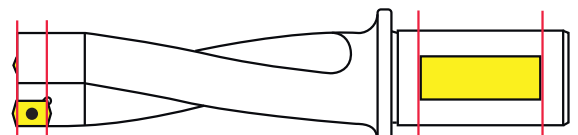

Pinze Cono Morse

Pinze Cono Morse per Mandrini / Morse Taper Collets

PROMO

3
pz / PCS

Ordine minimo
Minimum order

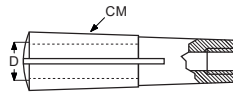

PROMO

5
pz / PCS

Ordine minimo
Minimum order

Cod. PROMO	PREZZO / PRICE Singola Pinza / Single Collet	Articolo / Item	D	CM	Cod. PROMO	PREZZO / PRICE Singola Pinza / Single Collet
PRM06-0001	€ 15,00	PNZ-01D02	2	1	PRM06-0018	€ 13,00
PRM06-0002	€ 15,00	PNZ-01D03	3	1	PRM06-0019	€ 13,00
PRM06-0003	€ 15,00	PNZ-01D04	4	1	PRM06-0020	€ 13,00
PRM06-0004	€ 15,00	PNZ-01D05	5	1	PRM06-0021	€ 13,00
PRM06-0005	€ 15,00	PNZ-01D06	6	1	PRM06-0022	€ 13,00
PRM06-0006	€ 15,00	PNZ-01D08	8	1	PRM06-0023	€ 13,00
PRM06-0007	€ 15,00	PNZ-02D03	3	2	PRM06-0024	€ 13,00
PRM06-0008	€ 15,00	PNZ-02D04	4	2	PRM06-0025	€ 13,00
PRM06-0009	€ 15,00	PNZ-02D05	5	2	PRM06-0026	€ 13,00
PRM06-0010	€ 15,00	PNZ-02D06	6	2	PRM06-0027	€ 13,00
PRM06-0011	€ 15,00	PNZ-02D08	8	2	PRM06-0028	€ 13,00
PRM06-0012	€ 15,00	PNZ-02D10	10	2	PRM06-0029	€ 13,00
PRM06-0013	€ 15,00	PNZ-02D12	12	2	PRM06-0030	€ 13,00
PRM06-0014	€ 15,00	PNZ-02D035	3,5	2	PRM06-0031	€ 13,00
PRM06-0015	€ 15,00	PNZ-02D045	4,5	2	PRM06-0032	€ 13,00
PRM06-0016	€ 15,00	PNZ-02D07	7	2	PRM06-0033	€ 13,00
PRM06-0017	€ 15,00	PNZ-02D09	9	2	PRM06-0034	€ 13,00

Mandrini MABT40 PC2

BT40 MAS 403

Mandrino Portapinza di Precisione / Precision Collet Holder

SET

**SOLO
MANDRINI
CHUCKS ONLY**

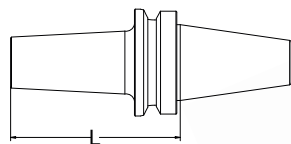

AcquaStream



KIT

**1 MANDRINO
+
7 PINZE
1 CHUCK + 7 COLLETS**



Composizione Set / Set Composition

Cod. PROMO	Articolo / Item	L	Q.ty	Prezzo / Price
PRM06-0035	MABT40 PC2 070	70	3 pz	€ 290,00
PRM06-0036	MABT40 PC2 100	100	3 pz	€ 300,00
PRM06-0037	MABT40 PC2 130	130	3 pz	€ 310,00
PRM06-0038	MABT40 PC2 070	70	5 pz	€ 420,00
PRM06-0039	MABT40 PC2 100	100	5 pz	€ 430,00
PRM06-0040	MABT40 PC2 130	130	5 pz	€ 440,00
PRM06-0041	MABT40 PC2 070	70	10 pz	€ 750,00
PRM06-0042	MABT40 PC2 100	100	10 pz	€ 760,00
PRM06-0043	MABT40 PC2 130	130	10 pz	€ 770,00

Kit 1 MANDRINO / CHUCK + 7 PINZE / COLLET

n° 1 Mandrino BT

n° 7 Pinze Ø 3/4/5/6/8/10/12

n° 1 Chiave di bloccaggio

n° 1 Dado di estrazione

Cod. PROMO

Prezzo / Price

PRM06-0044 (070)

€ 145,00

PRM06-0045 (100)

€ 145,00

PRM06-0046 (130)

€ 145,00

Mandrini MASK40 PC1

ISO40 DIN 69871

Mandrino Portapinza di Precisione / Precision Collet Holder

SET

**SOLO
MANDRINI
CHUCKS ONLY**

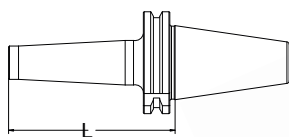

AcquaStream
by COMAND TOOL



KIT

**1 MANDRINO
+
6 PINZE
1 CHUCK + 6 COLLETS**



Composizione Set / Set Composition

Cod. PROMO	Articolo / Item	L	Q.ty	Prezzo / Price
PRM06-0047	MASK40 PC1 070	70	3 pz	€ 290,00
PRM06-0048	MASK40 PC1 100	100	3 pz	€ 300,00
PRM06-0049	MASK40 PC1 130	130	3 pz	€ 310,00
PRM06-0050	MASK40 PC1 070	70	5 pz	€ 420,00
PRM06-0051	MASK40 PC1 100	100	5 pz	€ 430,00
PRM06-0052	MASK40 PC1 130	130	5 pz	€ 440,00
PRM06-0053	MASK40 PC1 070	70	10 pz	€ 750,00
PRM06-0054	MASK40 PC1 100	100	10 pz	€ 760,00
PRM06-0055	MASK40 PC1 130	130	10 pz	€ 770,00

Kit 1 MANDRINO / CHUCK + 6 PINZE / COLLET

n° 1 Mandrino SK

n° 6 Pinze Ø 2/3/4/5/6/8

n° 1 Chiave di bloccaggio

Cod. PROMO

Prezzo / Price

PRM06-0056 (070)

€ 145,00

PRM06-0057 (100)

€ 145,00

PRM06-0058 (130)

€ 145,00

Mandrini MASK40 PC2

ISO40 DIN 69871

Mandrino Portapinza di Precisione / Precision Collet Holder

SET

**SOLO
MANDRINI
CHUCKS ONLY**

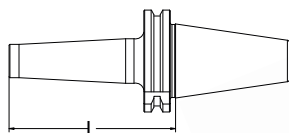

AcquaStream
by COMAND TOOL



KIT

**1 MANDRINO
+
7 PINZE
1 CHUCK + 7 COLLETS**



Composizione Set / Set Composition

Cod. PROMO	Articolo / Item	L	Q.ty	Prezzo / Price
PRM06-0059	MASK40 PC2 070	70	3 pz	€ 290,00
PRM06-0060	MASK40 PC2 100	100	3 pz	€ 300,00
PRM06-0061	MASK40 PC2 130	130	3 pz	€ 310,00
PRM06-0062	MASK40 PC2 070	70	5 pz	€ 420,00
PRM06-0063	MASK40 PC2 100	100	5 pz	€ 430,00
PRM06-0064	MASK40 PC2 130	130	5 pz	€ 440,00
PRM06-0065	MASK40 PC2 070	70	10 pz	€ 750,00
PRM06-0066	MASK40 PC2 100	100	10 pz	€ 760,00
PRM06-0067	MASK40 PC2 130	130	10 pz	€ 770,00

Kit 1 MANDRINO / CHUCK + 7 PINZE / COLLET

n° 1 Mandrino SK

n° 7 Pinze Ø 3/4/5/6/8/10/12

n° 1 Chiave di bloccaggio

Cod. PROMO

Prezzo / Price

PRM06-0068 (070)

€ 145,00

PRM06-0069 (100)

€ 145,00

PRM06-0070 (130)

€ 145,00

Mandrini MAHS63 PC1

Mandrino Portapinza di Precisione / Precision Collet Holder

SET

**SOLO
MANDRINI
CHUCKS ONLY**

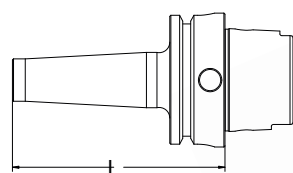

AcquaStream
by COMAND TOOL



Composizione Set / Set Composition

Cod. PROMO	Articolo / Item	L	Q.ty	Prezzo / Price
PRM06-0071	MAHS63 PC1 100	100	3 pz	€ 350,00
PRM06-0072	MAHS63 PC1 130	130	3 pz	€ 350,00
PRM06-0073	MAHS63 PC1 160	160	3 pz	€ 350,00
PRM06-0074	MAHS63 PC1 100	100	5 pz	€ 510,00
PRM06-0075	MAHS63 PC1 130	130	5 pz	€ 510,00
PRM06-0076	MAHS63 PC1 160	160	5 pz	€ 510,00
PRM06-0077	MAHS63 PC1 100	100	10 pz	€ 940,00
PRM06-0078	MAHS63 PC1 130	130	10 pz	€ 940,00
PRM06-0079	MAHS63 PC1 160	160	10 pz	€ 940,00

HSK63 DIN 69893

KIT

**1 MANDRINO
+
6 PINZE
1 CHUCK + 6 COLLETS**



Kit 1 MANDRINO / CHUCK + 6 PINZE / COLLET

n° 1 Mandrino HSK

n° 6 Pinze Ø 2/3/4/5/6/8

n° 1 Chiave di bloccaggio

Cod. PROMO

Prezzo / Price

PRM06-0080 (100)

€ 160,00

PRM06-0081 (130)

€ 160,00

PRM06-0082 (160)

€ 160,00

Mandrini MAHS63 PC2

Mandrino Portapinza di Precisione / Precision Collet Holder

SET

**SOLO
MANDRINI
CHUCKS ONLY**

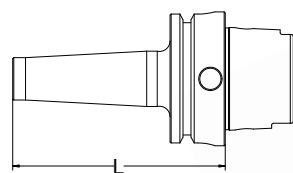

AcquaStream
by COMAND TOOL



Composizione Set / Set Composition

Cod. PROMO	Articolo / Item	L	Q.ty	Prezzo / Price
PRM06-0083	MAHS63 PC2 110	110	3 pz	€ 350,00
PRM06-0084	MAHS63 PC2 130	130	3 pz	€ 350,00
PRM06-0085	MAHS63 PC2 160	160	3 pz	€ 350,00
PRM06-0086	MAHS63 PC2 110	110	5 pz	€ 510,00
PRM06-0087	MAHS63 PC2 130	130	5 pz	€ 510,00
PRM06-0088	MAHS63 PC2 160	160	5 pz	€ 510,00
PRM06-0089	MAHS63 PC2 110	110	10 pz	€ 940,00
PRM06-0090	MAHS63 PC2 130	130	10 pz	€ 940,00
PRM06-0091	MAHS63 PC2 160	160	10 pz	€ 940,00

KIT

**1 MANDRINO
+
7 PINZE
1 CHUCK + 7 COLLETS**



Kit 1 MANDRINO / CHUCK + 7 PINZE / COLLET

n° 1 Mandrino HSK

n° 7 Pinze Ø 3/4/5/6/8/10/12

n° 1 Chiave di bloccaggio

Cod. PROMO

Prezzo / Price

PRM06-0092 (110)

€ 160,00

PRM06-0093 (130)

€ 160,00

PRM06-0094 (160)

€ 160,00

Mandrini MAC06 PC1

Poligonale C06

Mandrino Portapinza di Precisione - Attacco Poligonale / Precision Collet Holder - Polygonal Shank

SET

**SOLO
MANDRINI
CHUCKS ONLY**



AcquaStream
by COMAND TOOL

KIT

**1 MANDRINO
+
6 PINZE
1 CHUCK + 6 COLLETS**



Composizione Set / Set Composition

Cod. PROMO	Articolo / Item	L	Q.ty	Prezzo / Price
PRM06-0095	MAC06 PC1 100	100	3 pz	€ 350,00
PRM06-0096	MAC06 PC1 130	130	3 pz	€ 350,00
PRM06-0097	MAC06 PC1 160	160	3 pz	€ 350,00
PRM06-0098	MAC06 PC1 100	100	5 pz	€ 510,00
PRM06-0099	MAC06 PC1 130	130	5 pz	€ 510,00
PRM06-0100	MAC06 PC1 160	160	5 pz	€ 510,00
PRM06-0101	MAC06 PC1 100	100	10 pz	€ 940,00
PRM06-0102	MAC06 PC1 130	130	10 pz	€ 940,00
PRM06-0103	MAC06 PC1 160	160	10 pz	€ 940,00

Kit 1 MANDRINO / CHUCK + 6 PINZE / COLLET

n° 1 Mandrino C06

n° 6 Pinze Ø 2/3/4/5/6/8

n° 1 Chiave di bloccaggio

Cod. PROMO

Prezzo / Price

PRM06-0104 (100)

€ 160,00

PRM06-0105 (130)

€ 160,00

PRM06-0106 (160)

€ 160,00

Mandrini MAC06 PC2

Poligonale C06

Mandrino Portapinza di Precisione - Attacco Poligonale / Precision Collet Holder - Polygonal Shank

SET

**SOLO
MANDRINI
CHUCKS ONLY**



AcquaStream
by COMAND TOOL

KIT

**1 MANDRINO
+
7 PINZE
1 CHUCK + 7 COLLETS**



Composizione Set / Set Composition

Cod. PROMO	Articolo / Item	L	Q.ty	Prezzo / Price
PRM06-0107	MAC06 PC2 110	110	3 pz	€ 350,00
PRM06-0108	MAC06 PC2 130	130	3 pz	€ 350,00
PRM06-0109	MAC06 PC2 160	160	3 pz	€ 350,00
PRM06-0110	MAC06 PC2 110	110	5 pz	€ 510,00
PRM06-0111	MAC06 PC2 130	130	5 pz	€ 510,00
PRM06-0112	MAC06 PC2 160	160	5 pz	€ 510,00
PRM06-0113	MAC06 PC2 110	110	10 pz	€ 940,00
PRM06-0114	MAC06 PC2 130	130	10 pz	€ 940,00
PRM06-0115	MAC06 PC2 160	160	10 pz	€ 940,00

Kit 1 MANDRINO / CHUCK + 7 PINZE / COLLET

n° 1 Mandrino C06

n° 7 Pinze Ø 3/4/5/6/8/10/12

n° 1 Chiave di bloccaggio

Cod. PROMO

Prezzo / Price

PRM06-0116 (110)

€ 160,00

PRM06-0117 (130)

€ 160,00

PRM06-0118 (160)

€ 160,00

Smontaconi

DIN 69871 BT-HSK

Smontaconi Attacco Standard / Assembly Support Standard Shank

Sistema di bloccaggio a 45°/135° / Lock System 45°/135°



NUOVO CORPO IN ALLUMINIO
NEW ALUMINUM BODY



Cod. PROMO	Articolo / Item	Descrizione / Description	Q.tà / Q.ty	Prezzo / Price
PRM14-0001	SMT-CN30	Smontaconi per Mandrini ISO30 e BT30	1	€ 240,00
PRM14-0002	SMT-CN40	Smontaconi per Mandrini ISO40 e BT40	1	€ 240,00
PRM14-0003	SMT-CN50	Smontaconi per Mandrini ISO50 e BT50	1	€ 270,00
PRM14-0004	SMT-HSK63	Smontaconi per Mandrini HSK63	1	€ 260,00
PRM14-0005	SMT-HSK100	Smontaconi per Mandrini HSK100	1	€ 280,00

Smontaconi

Attacco Poligonale

Smontaconi Attacco Poligonale / Assembly Support Polygonal Shank



NUOVO ATTACCO
NEW SHANK
POLYGONAL "C"
DIN ISO 26623-1



Cod. PROMO	Articolo / Item	Descrizione / Description	Q.tà / Q.ty	Prezzo / Price
PRM14-0006	SMT-C04	Smontaconi per Mandrini Poligonali "C" 04	1	€ 270,00
PRM14-0007	SMT-C05	Smontaconi per Mandrini Poligonali "C" 05	1	€ 270,00
PRM14-0008	SMT-C06	Smontaconi per Mandrini Poligonali "C" 06	1	€ 270,00



Come scrivere un ordine

How to write an order

Quando si effettua un ordine specificare sempre il codice di promozione (Cod. PROMO - PRM...-...)

When placing an order always specify the promotion code (Cod. PROMO - PRM...-...)

Esempio d'ordine / Example of order

Cod. PROMO	Q.tà / Q.ty	Articolo / Item :	Ricevi / You receive:
PRM13-0001	1	SFS10-06-SCLCR06	1 Barra / Bar + 10 Inserti / Inserts
PRM12-0045	2	MTS-BMT45-C2C3C-A	6 Basi BMT / Basements
PRM12-0085	1	DCLNL-12-A / DWLNL-08-A / DER-16-B	3 Cartucce (a scelta) / Cartridges (of choice)
PRM08-0003	1	CHMR 2020K 34-B	1 Utensile / Tool + 8 Cartucce / Cartridges + 10 Inserti

Info

Per maggiori informazioni sui prodotti consultare i cataloghi:

For more information on the products see the catalogues:

Catalogo 19, DABtool, MiniDABtool e Planet System



Le informazioni contenute nei cataloghi o stampati pubblicitari, quali caratteristiche tecniche dei prodotti o dei componenti, dimensioni, schemi di montaggio, colori, ecc., hanno valore meramente indicativo, in ragione delle specifiche tecniche e della evoluzione tecnologica dei prodotti aziendali. I dati impegnativi potranno essere forniti di volta in volta e dietro esplicita richiesta.

Al fine di migliorare la qualità del prodotto, la **COMAND TOOL s.r.l.** si riserva il diritto di modificare lo stesso senza alcun preavviso e anche dopo l'accettazione dell'ordine. L'azienda si riserva di apportare modifiche parziali o totali ai prodotti senza preavviso declinando ogni responsabilità su eventuali dati inesatti.

23
PROMO

Easy Line

Comand Tool's annual promotions



finest metalworking solutions

COMAND TOOL srl

via dei Cascinotti, 2 - 26010 Credera-Rubbiano (CR) ITALIA

Tel. +39 0373 61107 - Fax: +39 0373 61427

vendite@comandtool.com - impex@comandtool.com

www.comandtool.com

 @ComandToolSrl

 @comand_tool

 Comand Tool