

DORMER  **PRAMET**

TALADRADO

2021 – 2022



 **DORMER**

 **PRAMET**



MECANIZADO DE AGUJEROS: ÍNDICE GENERAL

6		WMG E ISO 13399
12	BROCAS	INSTRUCCIONES
15		BROCAS DE METAL DURO INTEGRAL
66		BROCAS DE HSS
176		INFORMACIÓN TÉCNICA
186		ACEITES DE CORTE
190		ESCARIADORES Y AVELLANADORES
264	BROCAS DE PLAQUITA INTERCAMBIABLE	INSTRUCCIONES
271		BROCAS HYDRA
297		INFORMACIÓN TÉCNICA
307		BROCAS DE PLAQUITA INTERCAMBIABLE
327		INFORMACIÓN TÉCNICA
350	SISTEMAS DE MANDRILADO	INSTRUCCIONES
359		CABEZALES DE MANDRINADO
376		ACCESORIOS DE MANDRINADO
381		PLAQUITAS DE CORTE
404		ÚTILES DE SUJECCIÓN
418		KITS DE MANDRINADO
429		INFORMACIÓN TÉCNICA



FAMILIA DE PRODUCTOS		FAMILIA DE PRODUCTOS		FAMILIA DE PRODUCTOS		FAMILIA DE PRODUCTOS	
A		A243	120	B180	216	H	
A002	96	A244	121	B301	211	H851	287
A002S	98	A266	158	B334	208	H8512	294
A022	82	A295	172	B335	209	H853	289
A080	169	A296	173	B400	200	H855	291
A087	166	A345	146	B411	204	H858	293
A088	165	A350	144	B441	203	H860	295
A089	167	A400	150	B442	205	H861	296
A094	166	A402	151	B481	201	M	
A095	165	A405	152	B901	210	M150	173
A099	168	A412	153	B903	212	M151	174
A100	99	A413	154	B952	213	M152	174
A101	103	A510	111	B953	215	M200-1	187
A108	104	A520	88	B954	225	M200-2	187
A110	122	A530	140	B955	226	M200-3	188
A117	86	A553	113	B956	227	R	
A119	77	A620	84	B957	228	R100	34
A120	80	A720	91	G		R120	32
A122	78	A723	76	G106	238	R122	27
A123	79	A730	141	G107	242	R123	28
A124	90	A777	108	G125	249	R125	29
A125	128	A900	114	G129	234	R200	26
A130	134	A901	116	G132	244	R453	52
A147	106	A920	92	G135	230	R454	48
A160	110	A921	94	G136	236	R457	44
A166	143	A940	124	G137	232	R458	40
A170	118	A941	126	G138	245	R459	56
A188	172	A951	148	G142	240	R463	62
A190	170	A952	149	G149	235	R467	59
A191	171	A976	130	G154	233	R510	38
A199	169	A977	132	G171	247	R520	36
A200	155	A978	133	G236	250	R6011	30
A201	160	B		G314	248	R7131	31
A205	156	B100	206	G335	231	R950	281
A206	157	B101	222	G338	246	R960	283
A210	159	B121	224	G400	229	R970	285
A225	161	B122	214	G506	239		
A237	162	B157	220	G560	237		
A238	163	B161	221	G570	241		
A242	164	B170	218	G600	243		



FAMILIA DE PRODUCTOS		FAMILIA DE PRODUCTOS		FAMILIA DE PRODUCTOS		FAMILIA DE PRODUCTOS	
Z		BS 54 KIT TC 8-210	427	EXT-BS	415	M	
2080-BS	411	BT-BS	408	F		MB-H	373
69871-BS	406	C		F75	367	MOR-BS	413
802D	313	CART-BS-SPC	378	F75-BB	369	R	
803D	315	CART-BS-STD	379	F75-C	368	RED-BS	416
804D	318	CHAM-BS	380	F90	370	W	
805D	320	D		F90-BB	372	WEL-BS	414
B		D75	361	F90-C	371		
BS 54 KIT RC 8-043	420	D75-BB	363	H			
BS 54 KIT RC 8-100	421	D75-C	362	HSK-BS	410		
BS 54 KIT RC 8-170	422	D90	364	I			
BS 54 KIT RC 8-210	423	D90-BB	366	ISO BARS	374		
BS 54 KIT TC 8-043	424	D90-C	365	ISO BARS A042	375		
BS 54 KIT TC 8-100	425	E		L			
BS 54 KIT TC 8-170	426	EP	322	LA-BS	417		

FAMILIA DE PRODUCTOS		FAMILIA DE PRODUCTOS	
C		S	
CCGT	388	SCET	323
CCGW CBN	390	T	
CCMT	390	TCGT	401
CCMW	393	TCMT	402
CNGA CBN	394	TCMW	403
CNGG	395	W	
CNMA	395	WCMT-ID	325
CNMG	396	WCMX	326
D		X	
DCMT	398	XPET	324
DCMW	399		
DCMW PCD	399		
E			
EPGX	400		
EPMT	400		



CALCULADORA DE AHORRO

Nuestra calculadora de mecanizado le permite medir el ahorro en función de los distintos productos y aplicaciones. Una práctica herramienta de bolsillo que le ayudará a ahorrar costes. **Simplemente fiables..**

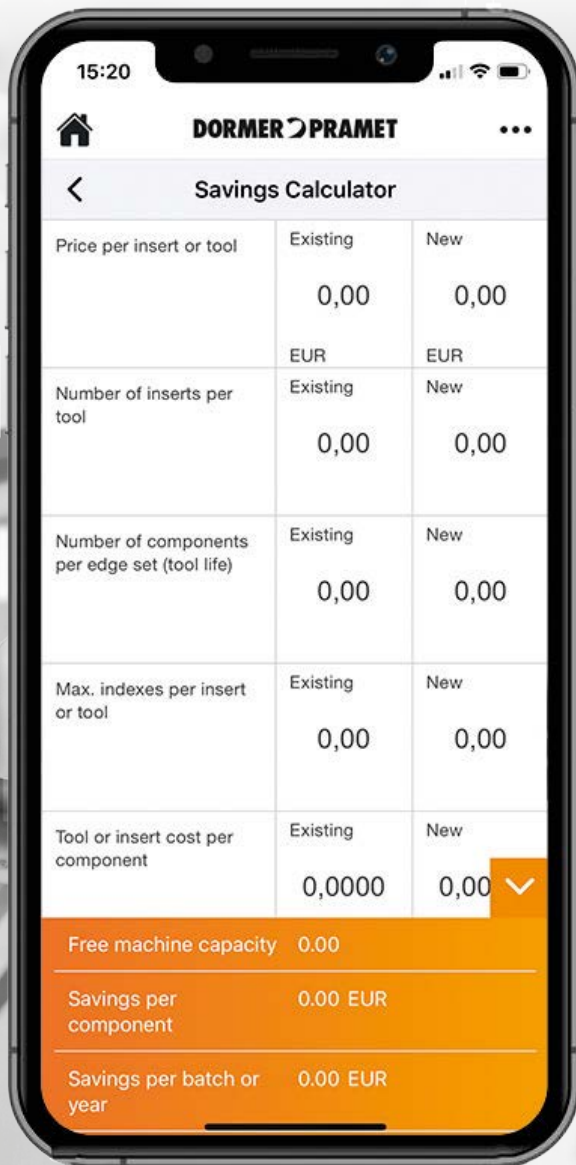



MECANIZADO DE AGUJEROS: ÍNDICE GENERAL

6		WMG E ISO 13399
12	BROCAS	INSTRUCCIONES
15		BROCAS DE METAL DURO INTEGRAL
66		BROCAS DE HSS
176		INFORMACIÓN TÉCNICA
186		ACEITES DE CORTE
190		ESCARIADORES Y AVELLANADORES
264	BROCAS DE PLAQUITA INTERCAMBIABLE	INSTRUCCIONES
271		BROCAS HYDRA
297		INFORMACIÓN TÉCNICA
307		BROCAS DE PLAQUITA INTERCAMBIABLE
327		INFORMACIÓN TÉCNICA
350	SISTEMAS DE MANDRILADO	INSTRUCCIONES
359		CABEZALES DE MANDRINADO
376		ACCESORIOS DE MANDRINADO
381		PLAQUITAS DE CORTE
404		ÚTILES DE SUJECCIÓN
418		KITS DE MANDRINADO
429		INFORMACIÓN TÉCNICA



GRUPOS DE MATERIALES (WMG)

ISO Para seleccionar una calidad y geometría de corte para una amplia gama de materiales a mecanizar

Definición general

P. ej., acero, acero inoxidable, etc.

P **M** **K** **N** **S** **H**

Subgrupo

Para navegar y seleccionar la herramienta idónea para una gama más específica de materiales a mecanizar

Definición por estructura/composición

P. ej., acero al carbono, acero aleado, etc.

P **M** **K** **N** **S** **H**

P1

P2

P3

P4

WMG

Para seleccionar y proporcionar condiciones de corte dentro de un rango de $\pm 10\%$

Definición por dureza/resistencia a la tracción

P. ej., $160 < 220$ HB, $620 < 900$ N/mm² ...

P

P1 **P1.1** **P1.2** **P1.3**

P2 **P2.1** **P2.2** **P2.3**

P3 **P3.1** **P3.2** **P3.3**

P4 **P4.1** **P4.2** **P4.3**

SOBRE LA CLASIFICACIÓN DE MATERIALES EN DORMER PRAMET

Los grupos de materiales («WMG») se utilizan para seleccionar de forma sencilla y fiable la herramienta de corte adecuada y los valores iniciales apropiados para las condiciones de mecanizado de aplicaciones específicas.

Dormer Pramet clasifica los materiales a mecanizar en seis grupos de diferentes colores:

- **Azul:** acero y acero fundido (grupo P);
- **Amarillo:** acero inoxidable (grupo M);
- **Rojo:** fundición (grupo K);
- **Verde:** materiales no férricos (grupo N);
- **Marrón:** aleaciones termoresistentes (grupo S);
- **Gris:** materiales endurecidos (grupo H).

Cada uno de estos grupos se divide, a su vez, en subgrupos según su estructura o composición. Por ejemplo, el grupo P de acero y acero fundido se desglosa en cuatro subgrupos:

- **P1 – Acero de fácil mecanizado**
- **P2 – Acero al carbono**
- **P3 – Acero aleado**
- **P4 – Acero para herramientas**

Finalmente, se realiza una última división en función de las propiedades del material, como la dureza y la resistencia a la tracción. Esta clasificación se lleva a cabo para ofrecer a nuestros clientes un asesoramiento completo sobre la herramienta y los valores iniciales de velocidad de corte y avance.

La tabla que se muestra en la página siguiente incluye una descripción de cada grupo de materiales a mecanizar, así como ejemplos de designaciones de uso común.



WMG (GRUPO DE MATERIAL)

GRUPO ISO	WMG (GRUPO DE MATERIAL)		Dureza (HB o HRC)	Restistencia Traccion (MPa)		
P	P1	P1.1	Sulfurizados	< 240 HB	≤ 830	
		P1.2	Acero de fácil mecanizado (aceros al carbono con mayor maquinabilidad)	Sulfurizados y fosforizados	< 180 HB	≤ 620
		P1.3		Sulfurizados/fosforizados y al plomo	< 180 HB	≤ 620
	P2	P2.1	ACEROS AL CARBONO (aceros compuestos principalmente de hierro y carbono)	Contiene < 0.25 % C	< 180 HB	≤ 620
		P2.2		Contiene < 0.55 % C	< 240 HB	≤ 830
		P2.3		Contiene > 0.55 % C	< 300 HB	≤ 1030
	P3	P3.1	ACEROS ALEADOS (aceros al carbono con un contenido de aleación del 10 %)	Recocido	< 180 HB	≤ 620
		P3.2		Templado y endurecido	180 – 260 HB	> 620 ≤ 900
		P3.3			260 – 360 HB	> 900 ≤ 1240
	P4	P4.1	ACERO DE HERRAMIENTAS (aleaciones especiales para herramientas, moldes y matrices)	Recocido	< 26 HRC	≤ 900
P4.2		Templado y endurecido		26 – 39 HRC	> 900 ≤ 1240	
P4.3				39 – 45 HRC	> 1240 ≤ 1450	
M	M1	M1.1	ACERO INOXIDABLE FERRITICO (aleaciones al cromo no endurecidas)	< 160 HB	≤ 520	
		M1.2		160 – 220 HB	> 520 ≤ 700	
	M2	M2.1	ACERO INOXIDABLE MARTENSITICO (aleaciones al cromo endurecidas)	Recocido	< 200 HB	≤ 670
		M2.2		Enfriadas y templadas	200 – 280 HB	> 670 ≤ 950
		M2.3		Templado por precipitación	280 – 380 HB	> 950 ≤ 1300
	M3	M3.1	ACERO INOXIDABLE AUSTENITICO (aleaciones cromo - níquel y cromo - níquel - manganeso)	< 200 HB	≤ 750	
		M3.2		200 – 260 HB	> 750 ≤ 870	
		M3.3		260 – 300 HB	> 870 ≤ 1040	
	M4	M4.1	AUTENITICO-FERRITICO (DUPLIX) O ACERO INOXIDABLE SUPER AUSTENITICO	< 300 HB	≤ 990	
		M4.2	ACEROS INOXIDABLE AUSTENITICOS ENDURECIDOS POR PRECIPITACION	300 – 380 HB	≤ 1320	
K	K1	K1.1	FUNDICION GRIS (ASTM A48) O FUNDICION GRIS AUTOMOCION (ASTM A159)	Ferrítica o ferrítica-perlítica	< 180 HB	≤ 190
		K1.2	(fundición hierro - carbono con micro estructura de grafito laminar)	Ferrítica-perlítica o perlítica	180 – 240 HB	> 190 ≤ 310
		K1.3		Perlítica	240 – 280 HB	> 310 ≤ 390
	K2	K2.1	FUNDICION MALEABLE (ASTM A602) (fundición de hierro-carbono con una microestructura libre de grafito)	Ferrítica	< 160 HB	≤ 400
		K2.2		Ferrítica o perlítica	160 – 200 HB	> 400 ≤ 550
		K2.3		Perlítica	200 – 240 HB	> 550 ≤ 660
	K3	K3.1	FUNDICION DÚCTIL (ASTM A536) (fundición de hierro-carbono con microestructura de grafito nodular)	Ferrítica	< 180 HB	≤ 560
		K3.2		Ferrítica o perlítica	180 – 220 HB	> 560 ≤ 680
		K3.3		Perlítica	220 – 260 HB	> 680 ≤ 800
	K4	K4.1	FUNDICION GRIS AUSTENITICO (ASTM A436) (fundiciones de aleación de hierro-carbono con microestructura de grafito laminar austenítico)		< 180 HB	≤ 190
		K4.2	FUNDICION DÚCTIL AUSTENITICA (ASTM A439 o ASTM A571) (fundiciones de hierro-carbono con microestructura de grafito nodular austenítico)		< 240 HB	≤ 740
		K4.3	FUNDICION DÚCTIL AUSTEMPERADA (ASTM A897) (fundiciones de hierro y carbono con microestructura de ausferrita)	< 280 HB	> 840 ≤ 980	
		K4.4		280 – 320 HB	> 980 ≤ 1130	
K4.5		320 – 360 HB		> 1130 ≤ 1280		
K5	K5.1	FUNDICION DE GRAFITO COMPACTADO CGI (ASTM A842) (fundición de hierro-carbono con estructura vermicular de grafito)	Ferrítico	< 180 HB	≤ 400	
	K5.2		Ferrítico-perlítico	180 – 220 HB	> 400 ≤ 450	
	K5.3		Perlítico	220 – 260 HB	> 450 ≤ 500	
N	N1	N1.1	Aluminio forjado comercialmente puro	< 60 HB	≤ 240	
		N1.2	Aleaciones de aluminio forjado	Templado medio	60 – 100 HB	> 240 ≤ 400
		N1.3		Templado completo	100 – 150 HB	> 400 ≤ 590
	N2	N2.1	Fundición de aluminio	< 75 HB	≤ 240	
		N2.2		75 – 90 HB	> 240 ≤ 270	
		N2.3		90 – 140 HB	> 270 ≤ 440	
	N3	N3.1	Aleaciones de cobre de fácil mecanización	–	–	
		N3.2	Aleaciones de cobre de viruta corta con maquinabilidad moderada	–	–	
		N3.3	Cobre electrolítico y aleaciones de cobre de viruta larga con baja maquinabilidad	–	–	
	N4	N4.1	Polimeros termoplasticos	–	–	
		N4.2	Polimeros termoendurecibles	–	–	
		N4.3	Composites o polimeros reforzados	–	–	
	N5	N5.1	Grafito	–	–	
S	S1	S1.1	Titanio o aleaciones de titanio	< 200 HB	≤ 660	
		S1.2		200 – 280 HB	> 660 ≤ 950	
		S1.3		280 – 360 HB	> 950 ≤ 1200	
	S2	S2.1	Aleaciones termorresistentes con base hierro	< 200 HB	≤ 690	
		S2.2		200 – 280 HB	> 690 ≤ 970	
	S3	S3.1	Aleaciones termorresistentes con base níquel	< 280 HB	≤ 940	
		S3.2		280 – 360 HB	> 940 ≤ 1200	
	S4	S4.1	Aleaciones termorresistentes con base cobalto	< 240 HB	≤ 800	
S4.2		240 – 320 HB		> 800 ≤ 1070		
H	H1	H1.1	Fundicion en frio	< 440 HB	–	
		H1.2	Fundiciones templadas	< 55 HRC	–	
	H2.1	> 55 HRC		–		
	H3	H3.1	Aceros templados < 55 HRC	< 51 HRC	–	
		H3.2		51 – 55 HRC	–	
	H4	H4.1	Acero templados > 55 HRC	55 – 59 HRC	–	
H4.2		> 59 HRC		–		



PARÁMETROS DE HERRAMIENTAS DE CORTE SEGÚN ISO 13399

Todas las herramientas de corte están definidas por una serie de parámetros según la norma ISO 13399. Esta lista contiene todos los parámetros utilizados en este catálogo y sus definiciones.

ISO 13399 es una norma internacional de información sobre herramientas de corte. Proporciona dimensiones y parámetros en un formato neutro que es independiente de cualquier sistema particular o nomenclatura de empresa. Cuando las herramientas de corte están claramente definidas de acuerdo con un estándar global, todos los tipos de software pueden procesar los datos electrónicos más rápidamente, mejorando la calidad de la comunicación y ayudando a que el intercambio de información se realice sin problemas. Admitir un

lenguaje común en nuestras descripciones de herramientas de corte ayudará a la comunicación entre sistemas. Le ahorrará una cantidad significativa de tiempo, proporcionando una recopilación más fácil de datos de alta calidad en nuestras 40.000 herramientas integrales e intercambiables. Al utilizar un sistema compatible con ISO 13399, no habrá necesidad de interpretar manualmente los datos e ingresarlos con una clave en su sistema.

Ejemplos

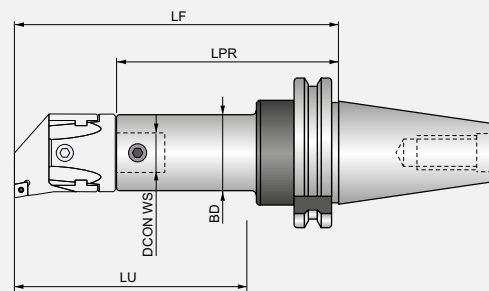
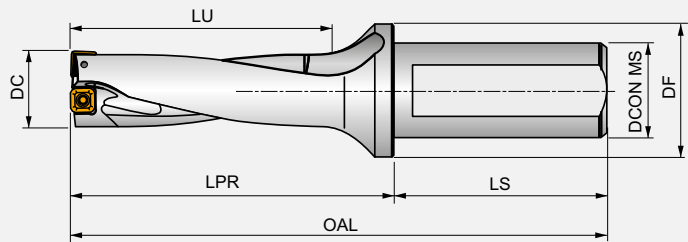
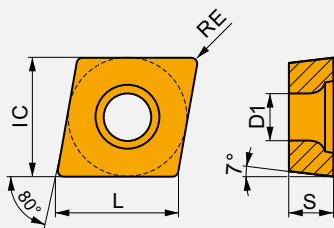
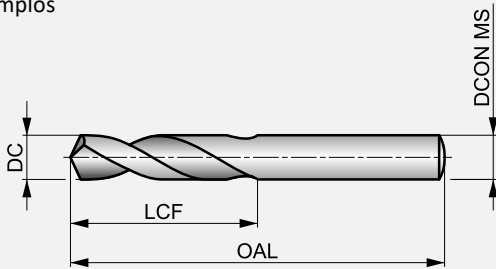

ISO 13399	Descripción
BD	Diámetro del cuerpo
BDX	Diámetro del cuerpo máximo
CZC MS	Código de tamaño de conexión del lado de la máquina
D1	Diámetro del agujero de fijación
DC	Diámetro de corte
DCN	Diámetro de corte mínimo
DCON MS	Diámetro de conexión del lado de la máquina
DCON WS	Diámetro de conexión del lado de la pieza
DCX	Diámetro de corte máximo
DHUB	Diámetro de apoyo
FLGT	Espesor de ala
IC	Diámetro de la circunferencia inscrita
L	Longitud del filo de corte
LB	Longitud del cuerpo
LF	Longitud funcional
LPR	Longitud del saliente
LU	Longitud útil
OAL	Longitud total
RE	Radio angular
S	Espesor de la plaquita de corte
WF	Ancho funcional
APMX	Profundidad de corte máxima
D1	Diámetro del agujero de fijación
DC_1	Diámetro del primer paso de corte
DC_2	Diámetro del segundo paso de corte

ISO 13399	Descripción
DF	Diámetro del ala
DH	Diámetro del cabezal
GPD	Diámetro del piloto guía
GPL	Longitud del piloto guía
H	Altura del mango
HSD	Tamaño de la parte de accionamiento
IC	Diámetro de la circunferencia inscrita
LCF	Longitud del canal de virutas
LCOL	Longitud de la pinza
LDC	Distancia punto de referencia PK
LH	Longitud del cabezal
LS	Longitud del mango
LSC	Longitud de sujeción
NOF	Número de canales
PLGL	Longitud de la punta semicónica
RCSK	Radio del avellanador
RE	Radio angular
SDI	Incrementos del diámetro de paso
SDL	Longitud del diámetro de paso
SDL_1	Longitud del diámetro de paso del primer paso de corte
SDL_2	Longitud del diámetro de paso del segundo paso de corte
TDZ	Tamaño del diámetro de rosca
THLGTH	Longitud de rosca
WSC	Ancho de fijación



DORMER PRAMET



UNA BIBLIOTECA A SU MEDIDA

¿Consulta siempre las mismas secciones de nuestras publicaciones? Nuestra aplicación de biblioteca le permite guardar páginas clave a las que puede volver una y otra vez siempre que lo necesite. Simplemente fiables.





BROCAS DE METAL DURO INTEGRAL
BROCAS DE HSS





MECANIZADO DE AGUJEROS: ÍNDICE GENERAL

6		WMG E ISO 13399
12	BROCAS	INSTRUCCIONES
15		BROCAS DE METAL DURO INTEGRAL
66		BROCAS DE HSS
176		INFORMACIÓN TÉCNICA
186		FLUIDOS DE CORTE
190		
264	BROCAS DE PLAQUITA INTERCAMBIABLE	INSTRUCCIONES
271		BROCAS HYDRA
295		INFORMACIÓN TÉCNICA
307		BROCAS DE PLAQUITA INTERCAMBIABLE
327		INFORMACIÓN TÉCNICA
350	SISTEMAS DE MANDRILADO	INSTRUCCIONES
359		CABEZALES DE MANDRILADO
376		ACCESORIOS DE MANDRINADO
381		PLAQUITAS DE CORTE
404		MANDRILES
418		KITS DE MANDRINADO
429		INFORMACIÓN TÉCNICA



1 R100



Broca Metal Duro, Serie Corta, Acabado Brillante

Resistencia al desgaste mejorada para aumentar la productividad y prolongar la vida útil de la herramienta. La punta a 120° con 4 facetas favorece el auto-centrado y reduce las fuerzas de corte. Se puede utilizar en todas las aplicaciones de máquinas CNC.

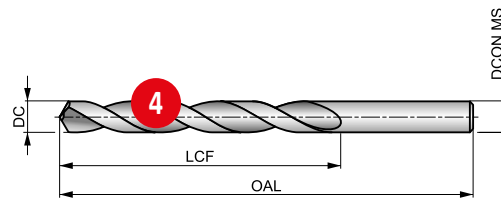

HM	DIN 338	4xD
120°	Bright	
20-35°	R	DC h7

5

Grupo de Material de la pieza adecuado y condiciones de velocidad de corte iniciales (m/min) y código de avance alfabético. Tablas con avance por revolución a partir de la pag.65.

P1.1	P1.2	P1.3	P2.1	P2.2	P2.3	P3.1	P3.2	P3.3	P4.1	P4.2	P4.3	K1.1	K1.2
99 S	111 S	115 S	85 S	75 S	66 S	66 S	53 S	45 S	40 S	34 S	27 S	75 T	56 T
K1.3	K2.1	K2.2	K2.3	K3.1	K3.2	K3.3	K4.1	K4.2	K4.3	K4.4	K4.5	K5.1	K5.2
42 T	68 T	55 T	44 T	60 T	46 T	37	55 T	42 T	31 T	26 T	22 T	63 T	47 T
K5.3	N1.1	N1.2	N1.3	N2.1	N2.2	N2.3	N3.1	N3.2	N4.1	N4.2	H1.1	H2.1	H2.2
37 T	200 V	150 V	100 V	172 V	155 V	112 V	423 V	250 V	60 X	100 V	56 S	33 S	36 S
H3.1	H3.2												
37 S	30 S												

6

Product	DC [mm]	DC [inch]	LCF [mm]	OAL [mm]	DCON MS [mm]
R1001.0	1.00	0.0394	12.0	34.0	1.00
R1001.1	1.10	0.0433	14.0	36.0	1.10
R1001.2	1.20	0.0472	16.0	38.0	1.20
R1001.3	1.30	0.0512	16.0	38.0	1.30
R1001.4	1.40	0.0551	18.0	40.0	1.40
R1001.5	1.50	0.0591	18.0	40.0	1.50
R1001.6	1.60	0.0630	20.0	43.0	1.60
R1001.7	1.70	0.0669	20.0	43.0	1.70
R1001.8	1.80	0.0709	22.0	46.0	1.80
R1001.9	1.90	0.0748	22.0	46.0	1.90
R1002.0	2.00	0.0787	24.0	49.0	2.00

8

Product	DC [mm]	DC [inch]	LCF [mm]	OAL [mm]	DCON MS [mm]
R1003.6	3.60	0.1417	39.0	70.0	3.60
R1003.7	3.70	0.1457	39.0	70.0	3.70
R1003.8	3.80	0.1496	43.0	75.0	3.80
R1003.9	3.90	0.1535	43.0	75.0	3.90
R1004.0	4.00	0.1575	43.0	75.0	4.00
R1004.1	4.10	0.1614	43.0	75.0	4.10
R1004.2	4.20	0.1654	43.0	75.0	4.20
R1004.3	4.30	0.1693	47.0	80.0	4.30
R1004.4	4.40	0.1732	47.0	80.0	4.40
R1004.5	4.50	0.1772	47.0	80.0	4.50
R1004.6	4.60	0.1811	47.0	80.0	4.60

Pos.	Descripción
1	Denominación de la broca
2	Descripción del producto
3	Imagen
4	Representación esquemática de la herramienta

Pos.	Descripción
5	Características del producto
6	Recomendaciones de grupos de materiales, incluidas la velocidad de corte y la guía de avance
7	Código de producto
8	Dimensiones del producto



BROCAS DE METAL DURO Y HSS: RESUMEN DE SÍMBOLOS

SÍMBOLOS GENERALES

	Uso principal		Uso posible
--	---------------	--	-------------

ÁNGULO DE APLICACIÓN

	Broca de centrar avellanada a 60°		Radio de avellanado broca de centrar		Pretaladrado con chaflán a 90° (para roscado con macho)
	Punta de la broca 118°		Punta de la broca de puntear a 90°/120°		Punta de la broca de puntear 150°
	Punta de la broca 120°		Punta de la broca de puntear para soldadura a 180°		Punta de la broca de puntear 90°
	Punta de la broca 122°		Taladrado escalonado (para elementos de fijación), escariado a 180°		Punta de la broca de puntear 120°
	Punta de la broca 130°		Taladrado escalonado (para elementos de fijación), escariado a 90°		
	Punta de la broca 135°		Punta de la broca 140°		

GRUPO DE NORMAS BÁSICO (BSG)

	BS 328 - Normas sobre brocas y escariadores		DIN 1899 - Normas sobre microbrocas		DIN 8037 - Normas sobre brocas con punta de metal duro
	DIN 1869 / 1 - Normas sobre brocas extralargas con mango recto		DIN 333A - Normas sobre brocas de centrar		DIN 8374 - Normas sobre brocas bidiametrales
	DIN 1869 / 2 - Normas sobre brocas extralargas con mango recto		DIN 333R - Normas sobre avellanadores de mango recto		DIN 8376 - Normas sobre brocas escalonadas
	DIN 1869 / 3 - Normas sobre brocas extralargas con mango recto		DIN 338 - Normas sobre brocas de mango recto		DIN 8377 - Normas sobre brocas bidiametrales
	DIN 1870 (1) - Normas sobre brocas extralargas con mango cónico Morse		DIN 340 - Normas sobre brocas de longitud cónica		Normas DIN/ANSI
	DIN 1870 (2) - Normas sobre brocas extralargas con mango cónico Morse		DIN 341 - Normas sobre brocas largas de mango cónico Morse		Normas Dormer
	DIN 1897 - Normas sobre brocas extracortas		DIN 345 - Normas sobre brocas de mango cónico Morse		NAS907 - Normas sobre brocas para aplicaciones aeroespaciales

RECUBRIMIENTO

	Nitruro de aluminio y cromo (con proceso de alisado)		Tratamiento superficial templado con bronce (óxido de bronce)		Nitruro de aluminio y titanio (con proceso de alisado)
	Brillante (sin recubrimiento)		Combinación brillante y templado al vapor		Recubrimiento de nitruro de aluminio y titanio
	Brillante y TiN (recubrimiento de la punta)		Tratamiento superficial templado al vapor (oxidación por vapor)		Recubrimiento de nitruro de titanio



BROCAS DE METAL DURO Y HSS: RESUMEN DE SÍMBOLOS

PROPIEDADES DE SUMINISTRO DE REFRIGERANTE (CSP)



Refrigeración interna

DIRECCIÓN DE CORTE



Giro/corte a la izquierda



Giro/corte a la derecha

CLASE DE TOLERANCIA DEL DIÁMETRO DE CORTE (TCDC)

DC
h8

h8 - Clase de tolerancia de la herramienta estándar en la industria (en función del margen de diámetros)

DC
h7

h7 - Clase de tolerancia de la herramienta estándar en la industria (en función del margen de diámetros)

DC
m7

m7 - Clase de tolerancia de la herramienta estándar en la industria (en función del margen de diámetros)

DC
h6

h6 - Clase de tolerancia de la herramienta estándar en la industria (en función del margen de diámetros)

CÓDIGO DE MATERIAL (BMC)

HM

Material duro

HSS
HM

Acero rápido (cuerpo de la herramienta) con metal duro (filo de corte)

HSS

Acero rápido

HSS-E

Acero rápido al Cobalto

MANGO



Mango cilíndrico/mango recto



Mango cilíndrico con espiga



Mango cónico Morse



Mango cilíndrico con cara plana



DIN 6535 HA mango cilíndrico



Mango cilíndrico reducido

FORMA HELICOIDAL



Diseño de canal helicoidal de evacuación rápida



Diseño de canal helicoidal de evacuación estándar



Diseño con alma continuamente adelgazada



Diseño de canal helicoidal de evacuación lenta



Diseño de canal helicoidal de evacuación rápida



Afilado especial

RELACIÓN ENTRE LONGITUD Y DIÁMETRO ÚTIL (ULDR)

1.25xD

Relación entre profundidad de la herramienta y diámetro útil 1,25xD

2.5xD

Relación entre profundidad de la herramienta y diámetro útil 2,5xD

5xD

Relación entre profundidad de la herramienta y diámetro útil 5xD

1.5xD

Relación entre profundidad de la herramienta y diámetro útil 1,5xD

20xD

Relación entre profundidad de la herramienta y diámetro útil 20xD

6xD

Relación entre profundidad de la herramienta y diámetro útil 6xD

10xD

Relación entre profundidad de la herramienta y diámetro útil 10xD

25xD

Relación entre profundidad de la herramienta y diámetro útil 25xD

8xD

Relación entre profundidad de la herramienta y diámetro útil 8xD

15xD

Relación entre profundidad de la herramienta y diámetro útil 15xD

3xD

Relación entre profundidad de la herramienta y diámetro útil 3xD

1xD

Relación entre profundidad de la herramienta y diámetro útil 1xD

4xD

Relación entre profundidad de la herramienta y diámetro útil 4xD



BROCAS DE METAL DURO INTEGRAL



FORCE X

BROCAS DE METAL DURO DE ALTO RENDIMIENTO

BROCAS DE PRODUCCIÓN VERSÁTILES PARA UNA AMPLIA GAMA DE MATERIALES

Las brocas de metal duro FORCE X están desarrolladas para aplicaciones de mecanizado de alto rendimiento en una amplia variedad de materiales, como aceros al carbono, aceros aleados hasta 1500 MPa y fundición. Las brocas FORCE X también funcionan muy bien en acero inoxidable y aluminio, lo que las convierte en primera opción ideal para empresas de mecanizado subcontratadas.

CARACTERÍSTICAS Y BENEFICIOS

- CTW  – Diseño único con alma continuamente adelgazada.
- Punta modificada dividida de 4 facetas y gran ángulo secundario en el cincel.
- Metal duro premium con sustrato micrograno y recubrimiento TiAlN.
- Opciones 3xD y 5xD disponibles con y sin refrigeración interna.
- 8xD con refrigeración interna.

EN COMPARACIÓN CON BROCAS CONVENCIONALES, LAS BROCAS FORCE X SON:

- **Excepcionalmente económicas** – Capaces de ser reafiladas muchas veces, lo que aumenta su vida útil de forma significativa.
- **Calidad y rendimiento consistentemente altos** – con excelente precisión posicional y control de virutas, asegurando una tolerancia y acabado superficial de calidad superior.
- **Mayor productividad** – con mayores velocidades y mayor vida de filo.



GAMA

3xD



R457

Refrigeración interna

R458

Sólida

- 3.00 – 20.00 mm
- 1/8 – 3/4 inch, N30 – N1, A – Z

5xD



R453

Refrigeración interna

R454

Sólida

- 3.00 – 20.00 mm
- 1/8 – 3/4 inch, N30 – N1, A – Z

8xD



R459

Refrigeración interna

- 3.00 – 16.00 mm
- 1/8 – 5/8 inch



FORCE X

BROCAS DE METAL DURO DE ALTO RENDIMIENTO



EJEMPLO DE MECANIZADO

			Acero de Fácil Mecanizado P1.3	Acero Aleado P3.3	Fundición Gris K1.2
Material			1.0718 (11SMnPb30)	1.6582 (34CrNiMo6)	0.6025 (GG-25)
Dureza		HB	180	325	215
Resistencia a la tracción		MPa	620	1120	260
Diámetro		mm	8 (R4578.0)	8 (R4598.0)	8 (R4538.0)
Profundidad del agujero		mm	3×D (24)	8×D (64)	5×D (40)
Velocidad de corte	V_c	m/min	207	73	77
Avance	f	mm/rev	0.26	0.14	0.26
Refrigeración			Interna, emulsión al 8 %	Interna, emulsión al 8 %	Interna, emulsión al 8 %



FORCE M

BROCAS DE METAL DURO DE ALTO RENDIMIENTO

BROCAS PARA PRODUCCIÓN DE ALTO VOLUMEN EN ACERO INOXIDABLE

Las brocas de metal duro FORCE M han sido diseñadas para proporcionar el mayor rendimiento y fiabilidad en operaciones de taladrado de acero inoxidable y super aleaciones termorresistentes. Las brocas FORCE M son ideales para aplicaciones donde es necesario taladrar una gran cantidad de agujeros con alta y constante precisión.

CARACTERÍSTICAS Y BENEFICIOS

- CTW  – Diseño único con alma continuamente adelgazada.
- Punta dividida de 4 facetas con forma S con un filo de corte muy afilado y diseño reforzado de la esquina exterior.
- Metal duro premium con sustrato micrograno y recubrimiento TiAlN.
- Opciones 3xD y 5xD disponibles con y sin refrigeración interna.
- 8xD con refrigeración interna disponible bajo petición.

EN COMPARACIÓN CON BROCAS CONVENCIONALES, LAS BROCAS FORCE M SON:

- **Rendimiento fiable** – con una acción de corte suave para evitar el endurecimiento del material y la aparición de filo de aportación.
- **Productividad optimizada** – con una excelente gestión de la viruta y una mejor distribución de las fuerzas para permitir un altos niveles de penetración.
- **Vida de filo excepcional** – con esquinas y filos de corte mas resistentes para prevenir la deformación plástica.



GAMA

3xD



R467

Refrigeración interna

- 3.00 – 16.00 mm
- 1/8 – 5/8 inch

5xD



R463

Refrigeración interna

- 3.00 – 16.00 mm
- 1/8 – 5/8 inch

8xD



R469

Refrigeración interna

Disponible bajo petición

- 3.00 – 16.00 mm
- 1/8 – 5/8 inch



FORCE M

BROCAS DE METAL DURO DE ALTO RENDIMIENTO



EJEMPLO DE MECANIZADO

			INOX ferrítico M1.2	INOX Austenítico M3.2	INOX de alta resistencia M4.1
Material			1.4104 (AISI 430F)	1.4401 (AISI 316)	1.4501 (Super DUPLEX)
Dureza		HB	220	200	240
Resistencia a la tracción		MPa	700	750	770
Diámetro		mm	8 (R4678.0)	8 (S-R4698.0)	8 (R4638.0)
Profundidad del agujero		mm	3×D (24)	8×D (64)	5×D (40)
Velocidad de corte	V_c	m/min	99	74	57
Avance	f	mm/rev	0.16	0.14	0.12
Refrigeración			Interna, emulsión al 8 %	Interna, emulsión al 8 %	Interna, emulsión al 8 %



FORCE N

BROCAS DE METAL DURO DE ALTO RENDIMIENTO

BROCAS DE ALTA PENETRACIÓN PARA ALUMINIO

Las brocas de metal duro FORCE N están recomendadas para operaciones de taladrado a alta velocidad en aleaciones de aluminio forjado y fundido. La geometría de corte y del canal están diseñadas específicamente para romper la viruta en trozos pequeños y manejables y facilitar así su evacuación. Las brocas FORCE N proporcionan un rendimiento y una vida útil superiores para las empresas de fabricación de volumen medio-alto.

CARACTERÍSTICAS Y BENEFICIOS

- Adelgazamiento especial del alma y un ángulo de hélice superior al estándar
- Geometría única con filos de corte convexos y punta autocentrante de 4 facetas.
- Metal duro premium con sustrato micrograno y acabado brillante.
- 5xD y 8xD con refrigeración interna bajo petición.

EN COMPARACIÓN CON BROCAS CONVENCIONALES, LAS BROCAS FORCE N PROPORCIONAN:

- **Rendimiento Superior** – con mayores velocidades y mayor vida de filo.
- **Solución económica** – que se puede utilizar en todos los tipos de aluminio, desde grados blandos hasta abrasivos.
- **Proceso optimizado** – diseñadas para reducir la fuerza de empuje, mejorando la calidad del agujero y reduciendo las rebabas que se forman a la salida del agujero al taladrar materiales blandos.

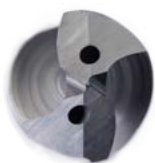

GAMA

5xD



R445

Refrigeración interna

Disponible bajo petición

- 3.00 – 16.00 mm
- 1/8 – 5/8 inch

8xD



R448

Refrigeración interna

Disponible bajo petición

- 3.00 – 16.00 mm
- 1/8 – 5/8 inch

Up to
12xD

Mayores longitudes disponibles bajo petición



FORCE N

BROCAS DE METAL DURO DE ALTO RENDIMIENTO



EJEMPLO DE MECANIZADO

			Aluminio forjado N1.2	Aluminio fundido N2.2
Material			AW 2024-O (3.1355)	A242.0
Dureza		HB	50	75
Resistencia a la tracción		MPa	200	220
Diámetro		mm	8 mm (R4458.0)	8 mm (S-R4488.0)
Profundidad del agujero		mm	5×D (40)	8×D (64)
Velocidad de corte	V_c	m/min	357	374
Avance	f	mm/rev	0.80	0.33
Refrigeración			Interna, emulsion al 8 %	Interna, emulsion al 8 %

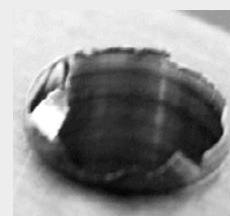

Exit burr with conventional drill

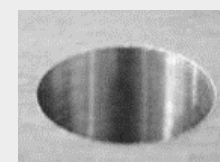

Exit burr with FORCE N drill



DORMER PRAMET

SÍGUENOS



COMPARTIR



ME GUSTA



COMENTAR



ETIQUETA



RE-TWEET







METAL DURO: NAVEGADOR DE MATERIALES DE HERRAMIENTA

Materiales de metal duro

Materiales de metal duro (o materiales duros)		<p>Un sustrato pulvimetalúrgico sinterizado, formado por un compuesto de carburo metálico con metal aglutinante. La materia prima más importante es el carburo de tungsteno (WC). El carburo de tungsteno contribuye al endurecimiento del material. El carburo de tántalo (TaC), el carburo de titanio (TiC) y el carburo de niobio (NbC) complementan al WC y adaptan sus propiedades según se desee. Estos tres materiales se conocen como carburos cúbicos. El cobalto (Co) actúa como aglutinante y mantiene el material unido.</p> <p>Los materiales de carburo suelen caracterizarse por su alta resistencia a la compresión, su elevada dureza y, por tanto, su alta resistencia al desgaste, pero también por su limitada resistencia a la flexión y por su tenacidad. El carburo se utiliza en machos de roscar, escariadores, fresas, brocas y fresas de roscar.</p>
------------------------------------------------------	-----------------------------------------------------------------------------------	---------------------------------------------------------------------------------------------------------------------------------------------------------------------------------------------------------------------------------------------------------------------------------------------------------------------------------------------------------------------------------------------------------------------------------------------------------------------------------------------------------------------------------------------------------------------------------------------------------------------------------------------------------------------------------------------------------------------------------------------------------------------------------------------------------------------------------------------------------------------------------

Recubrimientos superficiales

Brillante (sin recubrimiento)		<p>El acabado brillante (superficie sin recubrimiento) mejora el flujo de virutas en materiales suaves o materiales no féreos, plásticos y materiales compuestos, a la vez que mantiene afilados los filos de corte.</p>
Recubrimiento de nitruro de titanio (TiN)		<p>El nitruro de titanio es un recubrimiento cerámico de color dorado que se aplica por deposición física de vapor (PVD). La alta dureza, combinada con las propiedades de baja fricción, garantizan una vida útil más larga de la herramienta y/o un mejor rendimiento de corte de las herramientas que no están recubiertas.</p>
Recubrimientos de nitruro de Recubrimientos de nitruro (TiAlN)		<p>El nitruro de aluminio y titanio es un recubrimiento cerámico multicapa aplicado mediante la tecnología de recubrimiento PVD, que presenta una gran tenacidad y estabilidad a la oxidación. Estas propiedades lo convierten en ideal para alcanzar velocidades y avances más rápidos, al tiempo que mejora la vida útil de la herramienta. El TiAlN se utiliza en aplicaciones de taladrado, roscado con macho y fresado y es apropiado para el mecanizado sin refrigerante. El recubrimiento TiAlN-Top es el mismo que el TiAlN, pero con un proceso posterior al recubrimiento diseñado para suavizar las imperfecciones, mejorar el flujo de la viruta y reducir la formación de filos de aportación.</p>



Código de Material (BMC)	HM	HM	HM	HM	HM	HM	HM	HM	HM	HM	HM	HM	HM
Grupo básico estándar (BSG)	DIN 333A	DORMER	DORMER	DORMER	DORMER	DORMER	DIN 6539	DIN 338	DIN 6539	DIN 338	DIN 6537K	DIN 6537K	DIN 6537L
Longitud Útil (ULDR)	1xD	1xD	1xD	1xD	1xD	3xD	2.5xD	4xD	2.5xD	4xD	3xD	3xD	5xD
Ángulo de aplicación	60°	120°	90°	150°	90°	90°	120°	120°	130°	130°	140°	140°	140°
Recubrimiento	Bright	Bright	Bright	TIAIN	TIAIN	TIAIN	Bright	Bright	TIN	TIN	TIAIN	TIAIN	TIAIN
Mango					DIN 6535HA	DIN 6535HA					DIN 6535HA	DIN 6535HA	DIN 6535HA
Forma de la Hélice		λ 20-35°	λ 20-35°	λ 20-35°	λ 20-35°	λ 20-35°	λ 20-35°	λ 20-35°	λ 20-35°	λ 20-35°	CTW	CTW	CTW
Mano (dirección de corte)	R	R	R	R	R	R	R	R	R	R	R	R	R
Refrigeración (CSP)													
Código de Familia de Producto	R200	R122	R123	R125	R6011	R7131	R120	R100	R520	R510	R458	R457	R454
	1.00 - 5.00	5.00 - 20.00	5.00 - 20.00	6.00 - 16.00	6.00 - 16.00	3.30 - 10.40	1.00 - 12.00	1.00 - 14.00	3.00 - 16.50	3.00 - 14.25	3.00 - 20.00	3.00 - 20.00	3.00 - 20.00
	26	27	28	29	30	31	32	34	36	38	40	44	48
P	P1	■	■	■	■	■	■	■	■	■	■	■	■
	P2	■	■	■	■	■	■	■	■	■	■	■	■
	P3	■	■	■	■	■	■	■	■	■	■	■	■
	P4	■	■	■	■	■	■	■	■	■	■	■	■
M	M1		■	■	■	■			■	■	■	■	■
	M2		■	■	■	■			■	■	■	■	■
	M3		■	■	■	■			■	■	■	■	■
	M4						■				■	■	■
K	K1	■	■	■	■	■	■	■	■	■	■	■	■
	K2	■	■	■	■	■	■	■	■	■	■	■	■
	K3	■	■	■	■	■	■	■	■	■	■	■	■
	K4	■	■	■	■	■	■	■	■	■	■	■	■
	K5	■	■	■	■	■	■	■	■	■	■	■	■
N	N1	■	■	■	■	■	■	■	■	■	■	■	■
	N2	■	■	■	■	■	■	■	■	■	■	■	■
	N3	■	■	■	■	■	■	■	■	■	■	■	■
	N4		■	■	■	■	■	■	■	■	■	■	■
	N5												
S	S1		■	■	■	■	■	■	■	■	■	■	■
	S2		■	■	■	■	■	■	■	■	■	■	■
	S3		■	■	■	■	■	■	■	■	■	■	■
	S4		■	■	■	■	■	■	■	■	■	■	■
H	H1		■	■	■	■	■	■	■	■	■	■	■
	H2		■	■	■	■	■	■	■	■	■	■	■
	H3		■	■	■	■	■	■	■	■	■	■	■
	H4		■	■	■	■	■	■	■	■	■	■	■

■ Primera Opción ■ Opción Alternativa

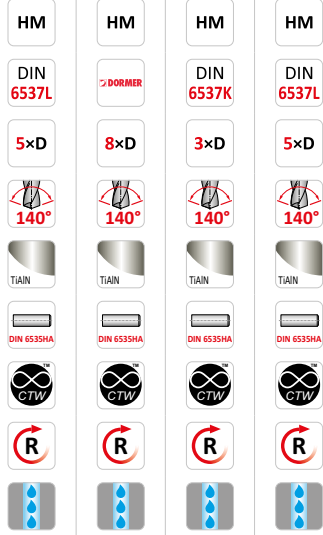

R453 R459 R467 R463

3.00 - 20.00 3.00 - 16.00 3.00 - 16.00 3.00 - 16.00

52 56 59 62

P1	■	■		
P2	■	■		
P3	■	■		
P4	■	■		
M1	☑	☑	■	■
M2	☑	☑	■	■
M3	☑	☑	■	■
M4	☑	☑	■	■
K1	■	■		
K2	■	■		
K3	■	■		
K4	■	■		
K5	■	■		
N1	■	☑		
N2	■	■		
N3	■	☑		
N4				
N5				
S1	■		■	■
S2			☑	☑
S3			☑	☑
S4			☑	☑
H1	■			
H2	☑			
H3	☑			
H4				



R200

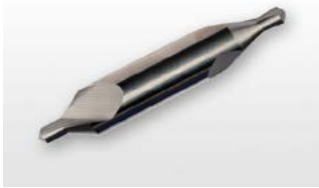

Broca Metal Duro con punta a 118° y Chafilán a 60°, Acabado Brillante

Recomendada para iniciar un agujero preciso en el extremo de un eje para poder sujetarlo de forma segura antes del mecanizado. Adecuada para taladrar la mayoría de materiales. Las puntas a ambos lados aumentan la productividad por herramienta. Punta a 118° y avellanador a 60°. Adecuada para todas las máquinas CNC.

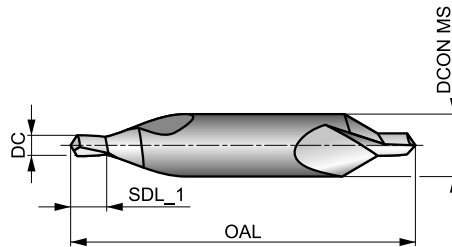

HM	DIN 333A	1xD
60°	Bright	
R		

Grupo de Material de la pieza adecuado y condiciones de velocidad de corte iniciales (m/min) y código de avance alfabético. Tablas con avance por revolución a partir de la pag. 65.

P1.1 ■ 60 H	P1.2 ■ 67 H	P1.3 ■ 69 H	P2.1 ■ 51 H	P2.2 ■ 45 F	P2.3 ■ 40 D	P3.1 ■ 44 E	P3.2 ■ 36 E	P3.3 ■ 30 D	P4.1 ■ 26 E	P4.2 ■ 22 D	P4.3 ■ 18 C	K1.1 ■ 40 H	K1.2 ■ 30 E
K1.3 ■ 22 E	K2.1 ■ 37 D	K2.2 ■ 30 D	K2.3 ■ 24 D	K3.1 ■ 33 D	K3.2 ■ 25 D	K3.3 ■ 20 D	K4.1 ■ 30 D	K4.2 ■ 23 D	K4.3 ■ 17 D	K4.4 ■ 14 D	K4.5 ■ 12 D	K5.1 ■ 34 D	K5.2 ■ 26 D
K5.3 ■ 20 D	N1.1 ■ 120 I	N1.2 ■ 90 I	N1.3 ■ 60 H	N2.1 ■ 154 G	N2.2 ■ 138 G	N2.3 ■ 100 G	N3.1 ■ 169 G	N3.2 ■ 100 H	N3.3 ■ 50 F				

Producto	DC	DC	SDL_1	OAL	DCON MS
	(mm)	(inch)			
R2001.0X3.15	1.00	0.0394	1.7 - 1.3	31.0	3.15
R2001.25X3.15	1.25	0.0492	2.0 - 1.6	31.0	3.15
R2001.6X4.0	1.60	0.0630	2.6 - 2.0	35.0	4.00
R2002.0X5.0	2.00	0.0787	3.1 - 2.5	40.0	5.00
R2002.5X6.3	2.50	0.0984	3.8 - 3.1	45.0	6.30
R2003.15X8.0	3.15	0.1240	4.6 - 3.9	50.0	8.00
R2004.0X10.0	4.00	0.1575	5.9 - 5.0	55.0	10.00
R2005.0X12.5	5.00	0.1969	7.2 - 6.3	63.0	12.50



R122



Broca de Centrar de Metal Duro, Punta a 120°

El ángulo de punta diseñado con precisión proporciona una guía precisa para favorecer el centrado de la siguiente broca. El ángulo de punta de 120° mejora el autocentrado y reduce las fuerzas de corte al taladrar una gran variedad de materiales.

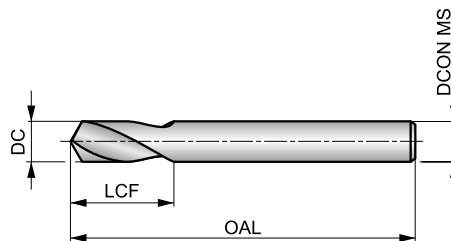

HM	DORMER	1xD
120°	Bright	
20-35°	R	DC h6

Grupo de Material de la pieza adecuado y condiciones de velocidad de corte iniciales (m/min) y código de avance alfabético. Tablas con avance por revolución a partir de la pag. 65.

P1.1 ■ 99 S	P1.2 ■ 111 S	P1.3 ■ 115 S	P2.1 ■ 85 S	P2.2 ■ 75 S	P2.3 ■ 66 S	P3.1 ■ 66 S	P3.2 ■ 53 S	P3.3 ■ 45 S	P4.1 ■ 40 S	P4.2 ■ 34 S	P4.3 ■ 27 S	M1.1 ■ 73 S	M1.2 ■ 61 S
M2.1 ■ 65 S	M2.2 ■ 53 S	M3.1 ■ 52 S	M3.2 ■ 45 S	K1.1 ■ 75 T	K1.2 ■ 56 T	K1.3 ■ 42 T	K2.1 ■ 68 T	K2.2 ■ 55 T	K2.3 ■ 44 T	K3.1 ■ 60 T	K3.2 ■ 46 T	K3.3 ■ 37 T	K4.1 ■ 55 T
K4.2 ■ 42 T	K4.3 ■ 31 T	K4.4 ■ 26 T	K4.5 ■ 22 T	K5.1 ■ 63 T	K5.2 ■ 47 T	K5.3 ■ 37 T	N1.1 ■ 200 V	N1.2 ■ 150 V	N1.3 ■ 100 V	N2.1 ■ 172 V	N2.2 ■ 155 V	N2.3 ■ 112 V	N3.1 ■ 423 V
N3.2 ■ 250 V	N3.3 ■ 125 V	N4.1 ■ 60 X	N4.2 ■ 100 V	S1.1 ■ 45 T	S1.2 ■ 35 T	S1.3 ■ 25 S	S2.1 ■ 40 S	S2.2 ■ 28 S	S3.1 ■ 30 S	S3.2 ■ 20 S	S4.1 ■ 23 S	S4.2 ■ 16 S	H1.1 ■ 56 S
H2.1 ■ 33 S	H2.2 ■ 36 S	H3.1 ■ 37 S	H3.2 ■ 30 S										

Producto	DC	DC	LCF	OAL	DCON MS
	(mm)	(inch)	(mm)	(mm)	(mm)
R1225.0	5.00	0.1969	16.0	62.0	5.00
R1226.0	6.00	0.2362	17.0	66.0	6.00
R1228.0	8.00	0.3150	22.0	79.0	8.00
R12210.0	10.00	0.3937	26.0	89.0	10.00
R12212.0	12.00	0.4724	30.0	102.0	12.00
R12216.0	16.00	0.6299	34.0	115.0	16.00
R12220.0	20.00	0.7874	40.0	131.0	20.00



R123



Broca de Centrar de Metal Duro, Punta a 90°

El ángulo de punta diseñado con precisión proporciona una guía precisa para favorecer el centrado de la siguiente broca. El ángulo de punta de 90° mejora el autocentrado y reduce las fuerzas de corte al taladrar una gran variedad de materiales.

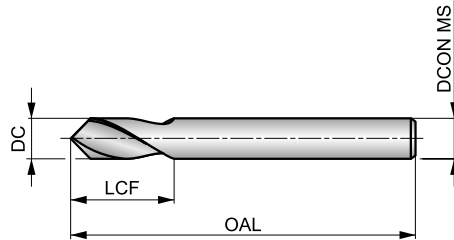

HM	DORMER	1xD
90°	Bright	
λ 20-35°	R	DC h6

Grupo de Material de la pieza adecuado y condiciones de velocidad de corte iniciales (m/min) y código de avance alfabético. Tablas con avance por revolución a partir de la pag. 65.

P1.1 ■ 99 S	P1.2 ■ 111 S	P1.3 ■ 115 S	P2.1 ■ 85 S	P2.2 ■ 75 S	P2.3 ■ 66 S	P3.1 ■ 66 S	P3.2 ■ 53 S	P3.3 ■ 45 S	P4.1 ■ 40 S	P4.2 ■ 34 S	P4.3 ■ 27 S	M1.1 ■ 73 S	M1.2 ■ 61 S
M2.1 ■ 65 S	M2.2 ■ 53 S	M3.1 ■ 52 S	M3.2 ■ 45 S	K1.1 ■ 75 T	K1.2 ■ 56 T	K1.3 ■ 42 T	K2.1 ■ 68 T	K2.2 ■ 55 T	K2.3 ■ 44 T	K3.1 ■ 60 T	K3.2 ■ 46 T	K3.3 ■ 37 T	K4.1 ■ 55 T
K4.2 ■ 42 T	K4.3 ■ 31 T	K4.4 ■ 26 T	K4.5 ■ 22 T	K5.1 ■ 63 T	K5.2 ■ 47 T	K5.3 ■ 37 T	N1.1 ■ 200 V	N1.2 ■ 150 V	N1.3 ■ 100 V	N2.1 ■ 172 V	N2.2 ■ 155 V	N2.3 ■ 112 V	N3.1 ■ 423 V
N3.2 ■ 250 V	N3.3 ■ 125 V	N4.1 ■ 60 X	N4.2 ■ 100 V	S1.1 ■ 45 T	S1.2 ■ 35 T	S1.3 ■ 25 S	S2.1 ■ 40 S	S2.2 ■ 28 S	S3.1 ■ 30 S	S3.2 ■ 20 S	S4.1 ■ 23 S	S4.2 ■ 16 S	H1.1 ■ 56 S
H2.1 ■ 33 S	H2.2 ■ 36 S	H3.1 ■ 37 S	H3.2 ■ 30 S										

Producto	DC	DC	LCF	OAL	DCON MS
	(mm)	(inch)			
R1235.0	5.00	0.1969	16.0	62.0	5.00
R1236.0	6.00	0.2362	17.0	66.0	6.00
R1238.0	8.00	0.3150	22.0	79.0	8.00
R12310.0	10.00	0.3937	26.0	89.0	10.00
R12312.0	12.00	0.4724	30.0	102.0	12.00
R12316.0	16.00	0.6299	34.0	115.0	16.00
R12320.0	20.00	0.7874	40.0	131.0	20.00

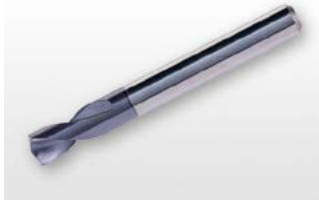
NEW**R125****DORMER**

Broca de Centrar de Metal Duro, Punta a 150°, Recubrimiento TiAlN

El ángulo de punta diseñado con precisión proporciona una guía precisa para favorecer el centrado de la siguiente broca. El ángulo de punta de 150° mejora el auto-centrado y reduce las fuerzas de corte al taladrar. El recubrimiento TiAlN mejora el rendimiento y prolonga la vida útil de la herramienta. Adecuada para taladrar muchos materiales.

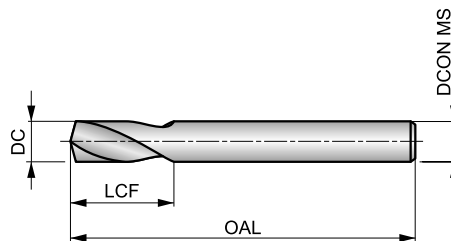

HM	DORMER	1×D
150°	TiAlN	
20-35°	R	DC h6

Grupo de Material de la pieza adecuado y condiciones de velocidad de corte iniciales (m/min) y código de avance alfabético. Tablas con avance por revolución a partir de la pag. 65.

P1.1 ■ 119 S	P1.2 ■ 134 S	P1.3 ■ 138 S	P2.1 ■ 102 S	P2.2 ■ 90 S	P2.3 ■ 80 S	P3.1 ■ 81 S	P3.2 ■ 65 S	P3.3 ■ 55 S	P4.1 ■ 48 S	P4.2 ■ 41 S	P4.3 ■ 34 S	M1.1 ■ 82 S	M1.2 ■ 70 S
M2.1 ■ 73 S	M2.2 ■ 60 S	M3.1 ■ 58 S	M3.2 ■ 50 S	K1.1 ■ 80 T	K1.2 ■ 59 T	K1.3 ■ 44 T	K2.1 ■ 86 T	K2.2 ■ 70 T	K2.3 ■ 56 T	K3.1 ■ 76 T	K3.2 ■ 58 T	K3.3 ■ 47 T	K4.1 ■ 71 T
K4.2 ■ 53 T	K4.3 ■ 39 T	K4.4 ■ 33 T	K4.5 ■ 28 T	K5.1 ■ 80 T	K5.2 ■ 60 T	K5.3 ■ 46 T	N1.1 ■ 200 V	N1.2 ■ 150 V	N1.3 ■ 100 V	N2.1 ■ 172 V	N2.2 ■ 155 V	N2.3 ■ 112 V	N3.1 ■ 423 V
N3.2 ■ 250 V	N3.3 ■ 125 V	N4.1 ■ 60 X	N4.2 ■ 100 V	S1.1 ■ 55 T	S1.2 ■ 45 T	S1.3 ■ 35 S	S2.1 ■ 53 S	S2.2 ■ 42 S	S3.1 ■ 40 S	S3.2 ■ 30 S	S4.1 ■ 31 S	S4.2 ■ 24 S	H1.1 ■ 56 S
H2.1 ■ 33 S	H2.2 ■ 36 S	H3.1 ■ 37 S	H3.2 ■ 30 S										

DCON MS tolerancia h6.

Producto	DC (mm)	LCF (mm)	OAL (mm)	DCON MS (mm)
R1255.0	5.00	16.0	62.0	5.00
R1256.0	6.00	17.0	66.0	6.00
R1258.0	8.00	22.0	79.0	8.00
R12510.0	10.00	26.0	89.0	10.00
R12512.0	12.00	30.0	102.0	12.00
R12516.0	16.00	34.0	115.0	16.00



R6011



Broca de Centrar de Metal Duro, Punta a 90°, Recubrimiento TiAlN

El ángulo de punta diseñado con precisión proporciona una guía precisa para favorecer el centrado de la siguiente broca. El ángulo de punta de 90° mejora el autocentrado y reduce las fuerzas de corte al taladrar. El recubrimiento TiAlN mejora el rendimiento y prolonga la vida útil de la herramienta. Adecuada para taladrar muchos materiales.

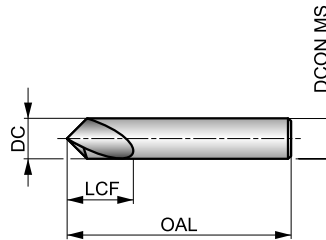

HM	DORMER	1xD
90°	TiAlN	DIN 6535HA
λ 20-35°	R	DC h6

Grupo de Material de la pieza adecuado y condiciones de velocidad de corte iniciales (m/min) y código de avance alfabético. Tablas con avance por revolución a partir de la pag. 65.

P1.1 ■ 119 S	P1.2 ■ 134 S	P1.3 ■ 138 S	P2.1 ■ 102 S	P2.2 ■ 90 S	P2.3 ■ 80 S	P3.1 ■ 81 S	P3.2 ■ 65 S	P3.3 ■ 55 S	P4.1 ■ 48 S	P4.2 ■ 41 S	P4.3 ■ 34 S	M1.1 ■ 82 S	M1.2 ■ 70 S
M2.1 ■ 73 S	M2.2 ■ 60 S	M3.1 ■ 58 S	M3.2 ■ 50 S	K1.1 ■ 80 T	K1.2 ■ 59 T	K1.3 ■ 44 T	K2.1 ■ 86 T	K2.2 ■ 70 T	K2.3 ■ 56 T	K3.1 ■ 76 T	K3.2 ■ 58 T	K3.3 ■ 47 T	K4.1 ■ 71 T
K4.2 ■ 53 T	K4.3 ■ 39 T	K4.4 ■ 33 T	K4.5 ■ 28 T	K5.1 ■ 80 T	K5.2 ■ 60 T	K5.3 ■ 46 T	N1.1 ■ 200 V	N1.2 ■ 150 V	N1.3 ■ 100 V	N2.1 ■ 172 V	N2.2 ■ 155 V	N2.3 ■ 112 V	N3.1 ■ 423 V
N3.2 ■ 250 V	N3.3 ■ 125 V	N4.1 ■ 60 X	N4.2 ■ 100 V	S1.1 ■ 55 T	S1.2 ■ 45 T	S1.3 ■ 35 S	S2.1 ■ 53 S	S2.2 ■ 42 S	S3.1 ■ 40 S	S3.2 ■ 30 S	S4.1 ■ 31 S	S4.2 ■ 24 S	H1.1 ■ 56 S
H2.1 ■ 33 S	H2.2 ■ 36 S	H3.1 ■ 37 S	H3.2 ■ 30 S										

DCON MS tolerancia h6.

Producto	DC (mm)	DC (inch)	LCF (mm)	OAL (mm)	DCON MS (mm)
R60116.0	6.00	0.2362	16.0	50.0	6.00
R601110.0	10.00	0.3937	25.0	70.0	10.00
R601116.0	16.00	0.6299	26.0	90.0	16.00



R7131



Broca Escalonada de Metal Duro, con Refrigeración Interna, Recubrimiento TiAIN

Versátil, con diámetros y longitudes de piloto específicos para lograr el tamaño y la profundidad de agujero para roscas métricas. Taladrar y achaflanar en una sola operación reduce el tiempo de ciclo y el inventario de herramientas. Ángulo de punta de 140° y avellanado de 90°. El recubrimiento TiAIN mejora el rendimiento y prolonga la vida útil de la herramienta. Apta para taladrar muchos materiales.

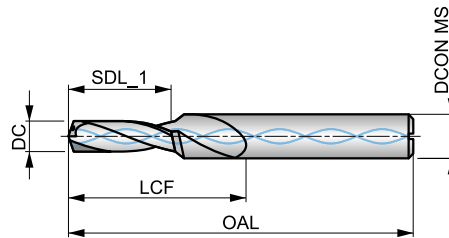

HM	DORMER	3xD
90°	TiAIN	DIN 6535HA
λ 20-35°	R	
DC m7		

Grupo de Material de la pieza adecuado y condiciones de velocidad de corte iniciales (m/min) y código de avance alfabético. Tablas con avance por revolución a partir de la pag. 65.

P1.1 ■ 139 W	P1.2 ■ 156 W	P1.3 ■ 161 W	P2.1 ■ 119 W	P2.2 ■ 105 W	P2.3 ■ 93 V	P3.1 ■ 96 V	P3.2 ■ 77 V	P3.3 ■ 65 V	P4.1 ■ 57 V	P4.2 ■ 48 V	M1.1 ■ 62 V	M1.2 ■ 52 V	M2.1 ■ 55 V
M2.2 ■ 45 V	M3.1 ■ 47 V	M3.2 ■ 40 V	M3.3 ■ 36 U	M4.1 ■ 35 U	K1.1 ■ 90 W	K1.2 ■ 67 W	K1.3 ■ 50 W	K2.1 ■ 92 V	K2.2 ■ 75 V	K2.3 ■ 60 V	K3.1 ■ 82 V	K3.2 ■ 62 V	K3.3 ■ 50 V
K4.1 ■ 76 V	K4.2 ■ 57 V	K4.3 ■ 42 V	K4.4 ■ 36 V	K4.5 ■ 30 V	K5.1 ■ 86 V	K5.2 ■ 64 V	K5.3 ■ 50 V	N1.1 ■ 250 W	N1.2 ■ 188 W	N1.3 ■ 125 W	N2.1 ■ 308 V	N2.2 ■ 277 V	N2.3 ■ 200 V
N3.1 ■ 373 W	N3.2 ■ 220 W	N3.3 ■ 110 W											

DCON MS tolerancia h6.

Producto	DC (mm)	DC (inch)	SDL_1 (mm)	LCF (mm)	OAL (mm)	DCON MS (mm)	TDZ
R71313.3	3.30	0.1299	11.40	20.0	66.0	6.00	M4
R71314.2	4.20	0.1654	13.60	24.0	66.0	6.00	M5
R71315.0	5.00	0.1969	16.50	28.0	79.0	8.00	M6
R71316.8	6.80	0.2677	21.00	34.0	89.0	10.00	M8
R71318.5	8.50	0.3346	25.50	47.0	102.0	12.00	M10
R713110.2	10.20	0.4016	30.00	55.0	107.0	14.00	M12
R713110.4	10.40	0.4094	30.00	55.0	107.0	14.00	M12



R120



Broca Metal Duro, Serie Extra Corta, Acabado Brillante

Resistencia al desgaste mejorada para aumentar la productividad y prolongar la vida útil de la herramienta. La punta a 120° con 4 facetas favorece el autocentrado y reduce las fuerzas de corte. Adecuada para taladrar materiales duros y abrasivos y se puede utilizar en todas las aplicaciones de máquinas CNC.

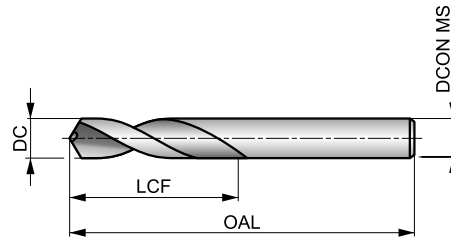

HM	DIN 6539	2.5xD
120°	Bright	
λ 20-35°	R	DC h7

Grupo de Material de la pieza adecuado y condiciones de velocidad de corte iniciales (m/min) y código de avance alfabético. Tablas con avance por revolución a partir de la pag. 65.

P1.1 □99 S	P1.2 □111 S	P1.3 □115 S	P2.1 □85 S	P2.2 □75 S	P2.3 □66 S	P3.1 □66 S	P3.2 □53 S	P3.3 □45 S	P4.1 □40 S	P4.2 □34 S	P4.3 □27 S	K1.1 □75 U	K1.2 □56 U
K1.3 □42 U	K2.1 □68 U	K2.2 □55 U	K2.3 □44 U	K3.1 □60 U	K3.2 □46 U	K3.3 □37 U	K4.1 □55 U	K4.2 □42 U	K4.3 □31 U	K4.4 □26 U	K4.5 □22 U	K5.1 □63 U	K5.2 □47 U
K5.3 □37 U	N1.1 ■200 W	N1.2 ■150 W	N1.3 □100 W	N2.1 □172 W	N2.2 □155 W	N2.3 □112 W	N3.1 □466 W	N3.2 □275 W	N3.3 ■138 W	N4.1 ■60 U	N4.2 ■100 U	S1.1 ■45 T	S1.2 □35 T
S1.3 □25 T	S2.1 □40 T	S2.2 □28 T	S3.1 □30 T	S3.2 □20 T	S4.1 □23 T	S4.2 □16 T	H1.1 □56 S	H2.1 □33 S	H2.2 □36 S	H3.1 □37 S	H3.2 □30 S		

Producto	DC (mm)	DC (inch)	LCF (mm)	OAL (mm)	DCON MS (mm)
R1201.0	1.00	0.0394	6.0	26.0	1.00
R1201.1	1.10	0.0433	7.0	28.0	1.10
R1201.2	1.20	0.0472	8.0	30.0	1.20
R1201.3	1.30	0.0512	8.0	30.0	1.30
R1201.4	1.40	0.0551	9.0	32.0	1.40
R1201.5	1.50	0.0591	9.0	32.0	1.50
R1201.6	1.60	0.0630	10.0	34.0	1.60
R1201.7	1.70	0.0669	10.0	34.0	1.70
R1201.8	1.80	0.0709	11.0	36.0	1.80
R1201.9	1.90	0.0748	11.0	36.0	1.90
R1202.0	2.00	0.0787	12.0	38.0	2.00
R1202.1	2.10	0.0827	12.0	38.0	2.10
R1202.2	2.20	0.0866	13.0	40.0	2.20
R1202.3	2.30	0.0906	13.0	40.0	2.30
R1202.4	2.40	0.0945	14.0	43.0	2.40
R1202.5	2.50	0.0984	14.0	43.0	2.50
R1202.6	2.60	0.1024	14.0	43.0	2.60
R1202.7	2.70	0.1063	16.0	46.0	2.70
R1202.8	2.80	0.1102	16.0	46.0	2.80
R1202.9	2.90	0.1142	16.0	46.0	2.90
R1203.0	3.00	0.1181	16.0	46.0	3.00
R1203.1	3.10	0.1220	18.0	49.0	3.10
R1203.2	3.20	0.1260	18.0	49.0	3.20
R1203.3	3.30	0.1299	18.0	49.0	3.30
R1203.4	3.40	0.1339	20.0	52.0	3.40
R1203.5	3.50	0.1378	20.0	52.0	3.50

Producto	DC (mm)	DC (inch)	LCF (mm)	OAL (mm)	DCON MS (mm)
R1203.6	3.60	0.1417	20.0	52.0	3.60
R1203.7	3.70	0.1457	20.0	52.0	3.70
R1203.8	3.80	0.1496	22.0	55.0	3.80
R1203.9	3.90	0.1535	22.0	55.0	3.90
R1204.0	4.00	0.1575	22.0	55.0	4.00
R1204.1	4.10	0.1614	22.0	55.0	4.10
R1204.2	4.20	0.1654	22.0	55.0	4.20
R1204.3	4.30	0.1693	24.0	58.0	4.30
R1204.4	4.40	0.1732	24.0	58.0	4.40
R1204.5	4.50	0.1772	24.0	58.0	4.50
R1204.6	4.60	0.1811	24.0	58.0	4.60
R1204.7	4.70	0.1850	24.0	58.0	4.70
R1204.8	4.80	0.1890	26.0	62.0	4.80
R1204.9	4.90	0.1929	26.0	62.0	4.90
R1205.0	5.00	0.1969	26.0	62.0	5.00
R1205.1	5.10	0.2008	26.0	62.0	5.10
R1205.2	5.20	0.2047	26.0	62.0	5.20
R1205.3	5.30	0.2087	26.0	62.0	5.30
R1205.4	5.40	0.2126	28.0	66.0	5.40
R1205.5	5.50	0.2165	28.0	66.0	5.50
R1205.6	5.60	0.2205	28.0	66.0	5.60
R1205.7	5.70	0.2244	28.0	66.0	5.70
R1205.8	5.80	0.2283	28.0	66.0	5.80
R1205.9	5.90	0.2323	28.0	66.0	5.90
R1206.0	6.00	0.2362	28.0	66.0	6.00
R1206.1	6.10	0.2402	31.0	70.0	6.10



Producto	DC	DC	LCF	OAL	DCON MS
	(mm)	(inch)	(mm)	(mm)	(mm)
R1206.2	6.20	0.2441	31.0	70.0	6.20
R1206.3	6.30	0.2480	31.0	70.0	6.30
R1206.4	6.40	0.2520	31.0	70.0	6.40
R1206.5	6.50	0.2559	31.0	70.0	6.50
R1206.6	6.60	0.2598	31.0	70.0	6.60
R1206.7	6.70	0.2638	31.0	70.0	6.70
R1206.8	6.80	0.2677	34.0	74.0	6.80
R1206.9	6.90	0.2717	34.0	74.0	6.90
R1207.0	7.00	0.2756	34.0	74.0	7.00
R1207.1	7.10	0.2795	34.0	74.0	7.10
R1207.2	7.20	0.2835	34.0	74.0	7.20
R1207.3	7.30	0.2874	34.0	74.0	7.30
R1207.4	7.40	0.2913	34.0	74.0	7.40
R1207.5	7.50	0.2953	34.0	74.0	7.50
R1207.6	7.60	0.2992	37.0	79.0	7.60
R1207.7	7.70	0.3031	37.0	79.0	7.70
R1207.8	7.80	0.3071	37.0	79.0	7.80
R1207.9	7.90	0.3110	37.0	79.0	7.90
R1208.0	8.00	0.3150	37.0	79.0	8.00
R1208.1	8.10	0.3189	37.0	79.0	8.10
R1208.2	8.20	0.3228	37.0	79.0	8.20
R1208.3	8.30	0.3268	37.0	79.0	8.30

Producto	DC	DC	LCF	OAL	DCON MS
	(mm)	(inch)	(mm)	(mm)	(mm)
R1208.4	8.40	0.3307	37.0	79.0	8.40
R1208.5	8.50	0.3346	37.0	79.0	8.50
R1208.6	8.60	0.3386	40.0	84.0	8.60
R1208.7	8.70	0.3425	40.0	84.0	8.70
R1208.8	8.80	0.3465	40.0	84.0	8.80
R1208.9	8.90	0.3504	40.0	84.0	8.90
R1209.0	9.00	0.3543	40.0	84.0	9.00
R1209.1	9.10	0.3583	40.0	84.0	9.10
R1209.2	9.20	0.3622	40.0	84.0	9.20
R1209.3	9.30	0.3661	40.0	84.0	9.30
R1209.4	9.40	0.3701	40.0	84.0	9.40
R1209.5	9.50	0.3740	40.0	84.0	9.50
R1209.6	9.60	0.3780	43.0	89.0	9.60
R1209.7	9.70	0.3819	43.0	89.0	9.70
R1209.8	9.80	0.3858	43.0	89.0	9.80
R1209.9	9.90	0.3898	43.0	89.0	9.90
R12010.0	10.00	0.3937	43.0	89.0	10.00
R12010.2	10.20	0.4016	43.0	89.0	10.20
R12010.5	10.50	0.4134	43.0	89.0	10.50
R12011.0	11.00	0.4331	47.0	95.0	11.00
R12011.5	11.50	0.4528	47.0	95.0	11.50
R12012.0	12.00	0.4724	51.0	102.0	12.00



R100



Broca Metal Duro, Serie Corta, Acabado Brillante

Resistencia al desgaste mejorada para aumentar la productividad y prolongar la vida útil de la herramienta. La punta a 120° con 4 facetas favorece el autocentrado y reduce las fuerzas de corte. Se puede utilizar en todas las aplicaciones de máquinas CNC.

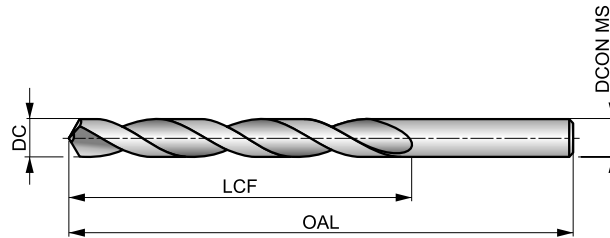

HM	DIN 338	4xD
120°	Bright	
λ 20-35°	R	DC h7

Grupo de Material de la pieza adecuado y condiciones de velocidad de corte iniciales (m/min) y código de avance alfabético. Tablas con avance por revolución a partir de la pag. 65.

P1.1 □99 S	P1.2 □111 S	P1.3 □115 S	P2.1 □85 S	P2.2 □75 S	P2.3 □66 S	P3.1 □66 S	P3.2 □53 S	P3.3 □45 S	P4.1 □40 S	P4.2 □34 S	P4.3 □27 S	K1.1 □75 T	K1.2 □56 T
K1.3 □42 T	K2.1 □68 T	K2.2 □55 T	K2.3 □44 T	K3.1 □60 T	K3.2 □46 T	K3.3 □37 T	K4.1 □55 T	K4.2 □42 T	K4.3 □31 T	K4.4 □26 T	K4.5 □22 T	K5.1 □63 T	K5.2 □47 T
K5.3 □37 T	N1.1 □200 V	N1.2 □150 V	N1.3 □100 V	N2.1 □172 V	N2.2 □155 V	N2.3 □112 V	N3.1 ■423 V	N3.2 ■250 V	N4.1 ■60 X	N4.2 ■100 V	H1.1 □56 S	H2.1 □33 S	H2.2 □36 S
H3.1 □37 S	H3.2 □30 S												

Producto	DC (mm)	DC (inch)	LCF (mm)	OAL (mm)	DCON MS (mm)
R1001.0	1.00	0.0394	12.0	34.0	1.00
R1001.1	1.10	0.0433	14.0	36.0	1.10
R1001.2	1.20	0.0472	16.0	38.0	1.20
R1001.3	1.30	0.0512	16.0	38.0	1.30
R1001.4	1.40	0.0551	18.0	40.0	1.40
R1001.5	1.50	0.0591	18.0	40.0	1.50
R1001.6	1.60	0.0630	20.0	43.0	1.60
R1001.7	1.70	0.0669	20.0	43.0	1.70
R1001.8	1.80	0.0709	22.0	46.0	1.80
R1001.9	1.90	0.0748	22.0	46.0	1.90
R1002.0	2.00	0.0787	24.0	49.0	2.00
R1002.1	2.10	0.0827	24.0	49.0	2.10
R1002.2	2.20	0.0866	27.0	53.0	2.20
R1002.3	2.30	0.0906	27.0	53.0	2.30
R1002.4	2.40	0.0945	30.0	57.0	2.40
R1002.5	2.50	0.0984	30.0	57.0	2.50
R1002.6	2.60	0.1024	30.0	57.0	2.60
R1002.7	2.70	0.1063	33.0	61.0	2.70
R1002.8	2.80	0.1102	33.0	61.0	2.80
R1002.9	2.90	0.1142	33.0	61.0	2.90
R1003.0	3.00	0.1181	33.0	61.0	3.00
R1003.1	3.10	0.1220	36.0	65.0	3.10
R1003.2	3.20	0.1260	36.0	65.0	3.20
R1003.3	3.30	0.1299	36.0	65.0	3.30
R1003.4	3.40	0.1339	39.0	70.0	3.40
R1003.5	3.50	0.1378	39.0	70.0	3.50

Producto	DC (mm)	DC (inch)	LCF (mm)	OAL (mm)	DCON MS (mm)
R1003.6	3.60	0.1417	39.0	70.0	3.60
R1003.7	3.70	0.1457	39.0	70.0	3.70
R1003.8	3.80	0.1496	43.0	75.0	3.80
R1003.9	3.90	0.1535	43.0	75.0	3.90
R1004.0	4.00	0.1575	43.0	75.0	4.00
R1004.1	4.10	0.1614	43.0	75.0	4.10
R1004.2	4.20	0.1654	43.0	75.0	4.20
R1004.3	4.30	0.1693	47.0	80.0	4.30
R1004.4	4.40	0.1732	47.0	80.0	4.40
R1004.5	4.50	0.1772	47.0	80.0	4.50
R1004.6	4.60	0.1811	47.0	80.0	4.60
R1004.7	4.70	0.1850	47.0	80.0	4.70
R1004.8	4.80	0.1890	52.0	86.0	4.80
R1004.9	4.90	0.1929	52.0	86.0	4.90
R1005.0	5.00	0.1969	52.0	86.0	5.00
R1005.1	5.10	0.2008	52.0	86.0	5.10
R1005.2	5.20	0.2047	52.0	86.0	5.20
R1005.3	5.30	0.2087	52.0	86.0	5.30
R1005.4	5.40	0.2126	57.0	93.0	5.40
R1005.5	5.50	0.2165	57.0	93.0	5.50
R1005.6	5.60	0.2205	57.0	93.0	5.60
R1005.7	5.70	0.2244	57.0	93.0	5.70
R1005.8	5.80	0.2283	57.0	93.0	5.80
R1005.9	5.90	0.2323	57.0	93.0	5.90
R1006.0	6.00	0.2362	57.0	93.0	6.00
R1006.1	6.10	0.2402	63.0	101.0	6.10



Producto	DC	DC	LCF	OAL	DCON MS
	(mm)	(inch)	(mm)	(mm)	(mm)
R1006.2	6.20	0.2441	63.0	101.0	6.20
R1006.3	6.30	0.2480	63.0	101.0	6.30
R1006.4	6.40	0.2520	63.0	101.0	6.40
R1006.5	6.50	0.2559	63.0	101.0	6.50
R1006.6	6.60	0.2598	63.0	101.0	6.60
R1006.7	6.70	0.2638	63.0	101.0	6.70
R1006.8	6.80	0.2677	69.0	109.0	6.80
R1006.9	6.90	0.2717	69.0	109.0	6.90
R1007.0	7.00	0.2756	69.0	109.0	7.00
R1007.1	7.10	0.2795	69.0	109.0	7.10
R1007.2	7.20	0.2835	69.0	109.0	7.20
R1007.3	7.30	0.2874	69.0	109.0	7.30
R1007.4	7.40	0.2913	69.0	109.0	7.40
R1007.5	7.50	0.2953	69.0	109.0	7.50
R1007.6	7.60	0.2992	75.0	117.0	7.60
R1007.7	7.70	0.3031	75.0	117.0	7.70
R1007.8	7.80	0.3071	75.0	117.0	7.80
R1007.9	7.90	0.3110	75.0	117.0	7.90
R1008.0	8.00	0.3150	75.0	117.0	8.00
R1008.1	8.10	0.3189	75.0	117.0	8.10
R1008.2	8.20	0.3228	75.0	117.0	8.20
R1008.3	8.30	0.3268	75.0	117.0	8.30
R1008.4	8.40	0.3307	75.0	117.0	8.40

Producto	DC	DC	LCF	OAL	DCON MS
	(mm)	(inch)	(mm)	(mm)	(mm)
R1008.5	8.50	0.3346	75.0	117.0	8.50
R1008.6	8.60	0.3386	81.0	125.0	8.60
R1008.7	8.70	0.3425	81.0	125.0	8.70
R1008.8	8.80	0.3465	81.0	125.0	8.80
R1008.9	8.90	0.3504	81.0	125.0	8.90
R1009.0	9.00	0.3543	81.0	125.0	9.00
R1009.1	9.10	0.3583	81.0	125.0	9.10
R1009.2	9.20	0.3622	81.0	125.0	9.20
R1009.3	9.30	0.3661	81.0	125.0	9.30
R1009.4	9.40	0.3701	81.0	125.0	9.40
R1009.5	9.50	0.3740	81.0	125.0	9.50
R1009.6	9.60	0.3780	87.0	133.0	9.60
R1009.7	9.70	0.3819	87.0	133.0	9.70
R1009.8	9.80	0.3858	87.0	133.0	9.80
R1009.9	9.90	0.3898	87.0	133.0	9.90
R10010.0	10.00	0.3937	87.0	133.0	10.00
R10010.2	10.20	0.4016	87.0	133.0	10.20
R10010.5	10.50	0.4134	87.0	133.0	10.50
R10011.0	11.00	0.4331	94.0	142.0	11.00
R10011.5	11.50	0.4528	94.0	142.0	11.50
R10012.0	12.00	0.4724	101.0	151.0	12.00
R10013.0	13.00	0.5118	101.0	151.0	13.00
R10014.0	14.00	0.5512	108.0	160.0	14.00



R520



Broca CDX Metal Duro, Serie Extra Corta, con Recubrimiento TiN

Broca de alto rendimiento, capaz de producir agujeros precisos y de alta calidad a altas velocidades y avances (tolerancia de agujero H8). El ángulo de punta de 130° favorece el auto-centrado y reduce las fuerzas de corte. El recubrimiento TiN mejora el rendimiento y prolonga la vida útil de la herramienta. Apto para todas las máquinas CNC y muchos materiales.



CDX

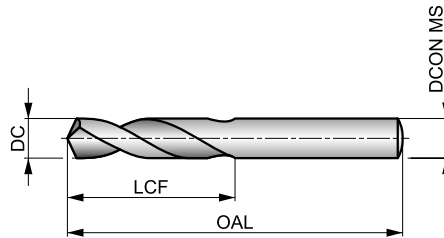

HM	DIN 6539	2.5×D
130°	TiN	
λ 20-35°	R	DC h7

Grupo de Material de la pieza adecuado y condiciones de velocidad de corte iniciales (m/min) y código de avance alfabético. Tablas con avance por revolución a partir de la pag. 65.

P1.1 ■ 119 X	P1.2 ■ 134 X	P1.3 ■ 138 X	P2.1 ■ 102 X	P2.2 ■ 90 X	P2.3 ■ 80 X	P3.1 ■ 81 X	P3.2 ■ 65 X	P3.3 ■ 55 X	P4.1 ■ 48 X	P4.2 ■ 41 X	P4.3 ■ 34 W	M1.1 ■ 69 W	M1.2 ■ 58 W
M2.1 ■ 61 W	M2.2 ■ 50 W	K1.1 ■ 90 Y	K1.2 ■ 67 Y	K1.3 ■ 50 Y	K2.1 ■ 80 X	K2.2 ■ 65 X	K2.3 ■ 52 X	K3.1 ■ 71 X	K3.2 ■ 54 X	K3.3 ■ 44 X	K4.1 ■ 66 X	K4.2 ■ 49 X	K4.3 ■ 36 X
K4.4 ■ 31 X	K4.5 ■ 26 X	K5.1 ■ 74 X	K5.2 ■ 56 X	K5.3 ■ 43 X	N1.1 ■ 225 Z	N1.2 ■ 169 Z	N1.3 ■ 113 Z	N2.1 ■ 231 Y	N2.2 ■ 208 Y	N2.3 ■ 150 Y	N4.1 ■ 75 Z	N4.2 ■ 115 V	S1.1 ■ 60 W
S1.2 ■ 45 V	S1.3 ■ 35 U	H1.1 ■ 65 U	H2.1 ■ 38 U	H2.2 ■ 36 T	H3.1 ■ 43 U	H3.2 ■ 35 U							

DCON MS tolerancia h7.

Producto	DC (inch)	DC (mm)	DC (inch)	LCF (mm)	OAL (mm)	DCON MS (mm)
R5203.0	-	3.00	0.1181	16.0	46.0	3.00
R5203.1	-	3.10	0.1220	18.0	49.0	3.10
R5201/8	1/8	3.18	0.1252	18.0	49.0	3.18
R5203.2	-	3.20	0.1260	18.0	49.0	3.20
R5203.3	-	3.30	0.1299	18.0	49.0	3.30
R5203.4	-	3.40	0.1339	20.0	52.0	3.40
R5203.5	-	3.50	0.1378	20.0	52.0	3.50
R5203.6	-	3.60	0.1417	20.0	52.0	3.60
R5203.7	-	3.70	0.1457	20.0	52.0	3.70
R5203.8	-	3.80	0.1496	22.0	55.0	3.80
R5203.9	-	3.90	0.1535	22.0	55.0	3.90
R5204.0	-	4.00	0.1575	22.0	55.0	4.00
R5204.1	-	4.10	0.1614	22.0	55.0	4.10
R5204.2	-	4.20	0.1654	22.0	55.0	4.20
R5204.3	-	4.30	0.1693	24.0	58.0	4.30
R5204.4	-	4.40	0.1732	24.0	58.0	4.40
R5204.5	-	4.50	0.1772	24.0	58.0	4.50
R5204.6	-	4.60	0.1811	24.0	58.0	4.60
R5204.7	-	4.70	0.1850	24.0	58.0	4.70
R5204.8	-	4.80	0.1890	26.0	62.0	4.80
R5204.9	-	4.90	0.1929	26.0	62.0	4.90
R5205.0	-	5.00	0.1969	26.0	62.0	5.00
R5205.1	-	5.10	0.2008	26.0	62.0	5.10
R5205.2	-	5.20	0.2047	26.0	62.0	5.20
R5205.3	-	5.30	0.2087	26.0	62.0	5.30

Producto	DC (inch)	DC (mm)	DC (inch)	LCF (mm)	OAL (mm)	DCON MS (mm)
R5205.4	-	5.40	0.2126	28.0	66.0	5.40
R5205.5	-	5.50	0.2165	28.0	66.0	5.50
R5205.6	-	5.60	0.2205	28.0	66.0	5.60
R5205.7	-	5.70	0.2244	28.0	66.0	5.70
R5205.8	-	5.80	0.2283	28.0	66.0	5.80
R5205.9	-	5.90	0.2323	28.0	66.0	5.90
R5206.0	-	6.00	0.2362	28.0	66.0	6.00
R5206.1	-	6.10	0.2402	31.0	70.0	6.10
R5206.2	-	6.20	0.2441	31.0	70.0	6.20
R5206.3	-	6.30	0.2480	31.0	70.0	6.30
R5201/4	1/4	6.35	0.2500	31.0	70.0	6.35
R5206.4	-	6.40	0.2520	31.0	70.0	6.40
R5206.5	-	6.50	0.2559	31.0	70.0	6.50
R5206.6	-	6.60	0.2598	31.0	70.0	6.60
R5206.7	-	6.70	0.2638	31.0	70.0	6.70
R5206.8	-	6.80	0.2677	34.0	74.0	6.80
R5206.9	-	6.90	0.2717	34.0	74.0	6.90
R5207.0	-	7.00	0.2756	34.0	74.0	7.00
R5207.1	-	7.10	0.2795	34.0	74.0	7.10
R5207.2	-	7.20	0.2835	34.0	74.0	7.20
R5207.3	-	7.30	0.2874	34.0	74.0	7.30
R5207.4	-	7.40	0.2913	34.0	74.0	7.40
R5207.5	-	7.50	0.2953	34.0	74.0	7.50
R5207.6	-	7.60	0.2992	37.0	79.0	7.60
R5207.7	-	7.70	0.3031	37.0	79.0	7.70



Producto	DC	DC	DC	LCF	OAL	DCON MS
	(inch)	(mm)	(inch)	(mm)	(mm)	(mm)
R5207.8	–	7.80	0.3071	37.0	79.0	7.80
R5207.9	–	7.90	0.3110	37.0	79.0	7.90
R5205/16	5/16	7.94	0.3126	37.0	79.0	7.94
R5208.0	–	8.00	0.3150	37.0	79.0	8.00
R5208.1	–	8.10	0.3189	37.0	79.0	8.10
R5208.2	–	8.20	0.3228	37.0	79.0	8.20
R5208.3	–	8.30	0.3268	37.0	79.0	8.30
R5208.4	–	8.40	0.3307	37.0	79.0	8.40
R5208.5	–	8.50	0.3346	37.0	79.0	8.50
R5208.6	–	8.60	0.3386	40.0	84.0	8.60
R5208.7	–	8.70	0.3425	40.0	84.0	8.70
R5208.8	–	8.80	0.3465	40.0	84.0	8.80
R5208.9	–	8.90	0.3504	40.0	84.0	8.90
R5209.0	–	9.00	0.3543	40.0	84.0	9.00
R5209.1	–	9.10	0.3583	40.0	84.0	9.10
R5209.2	–	9.20	0.3622	40.0	84.0	9.20
R5209.3	–	9.30	0.3661	40.0	84.0	9.30
R5209.4	–	9.40	0.3701	40.0	84.0	9.40
R5209.5	–	9.50	0.3740	40.0	84.0	9.50
R5203/8	3/8	9.52	0.3748	43.0	89.0	9.52
R5209.6	–	9.60	0.3780	43.0	89.0	9.60
R5209.7	–	9.70	0.3819	43.0	89.0	9.70
R5209.8	–	9.80	0.3858	43.0	89.0	9.80
R5209.9	–	9.90	0.3898	43.0	89.0	9.90

Producto	DC	DC	DC	LCF	OAL	DCON MS
	(inch)	(mm)	(inch)	(mm)	(mm)	(mm)
R52010.0	–	10.00	0.3937	43.0	89.0	10.00
R52010.1	–	10.10	0.3976	43.0	89.0	10.10
R52010.2	–	10.20	0.4016	43.0	89.0	10.20
R52010.3	–	10.30	0.4055	43.0	89.0	10.30
R52010.4	–	10.40	0.4094	43.0	89.0	10.40
R52010.5	–	10.50	0.4134	43.0	89.0	10.50
R52011.0	–	11.00	0.4331	47.0	95.0	11.00
R5207/16	7/16	11.11	0.4374	47.0	95.0	11.11
R52011.2	–	11.20	0.4409	47.0	95.0	11.20
R52011.5	–	11.50	0.4528	47.0	95.0	11.50
R52012.0	–	12.00	0.4724	51.0	102.0	12.00
R52012.5	–	12.50	0.4921	51.0	102.0	12.50
R5201/2	1/2	12.70	0.5000	51.0	102.0	12.70
R52013.0	–	13.00	0.5118	51.0	102.0	13.00
R52013.5	–	13.50	0.5315	54.0	107.0	13.50
R52014.0	–	14.00	0.5512	54.0	107.0	14.00
R52014.2	–	14.20	0.5591	56.0	111.0	14.20
R52014.25	–	14.25	0.5610	56.0	111.0	14.25
R52014.5	–	14.50	0.5709	56.0	111.0	14.50
R52015.0	–	15.00	0.5906	56.0	111.0	15.00
R52015.1	–	15.10	0.5945	58.0	115.0	15.10
R5205/8	5/8	15.88	0.6252	58.0	115.0	15.88
R52016.0	–	16.00	0.6299	58.0	115.0	16.00
R52016.5	–	16.50	0.6496	60.0	119.0	16.50



R510



Broca CDX Metal Duro, Serie Corta, con Recubrimiento TiN

Broca de alto rendimiento, capaz de producir agujeros precisos y de alta calidad a altas velocidades y avances (tolerancia de agujero H8). La punta a 130° facilita el autocentrado y reduce las fuerzas de corte. El recubrimiento TiN mejora el rendimiento y prolonga la vida de la herramienta. Adecuada para todas las máquinas CNC y para la mayoría de materiales.

CDX

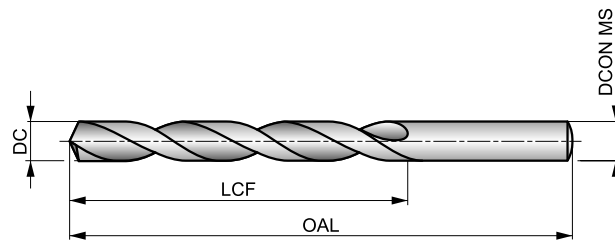

HM	DIN 338	4xD
130°	TiN	
λ 20-35°	R	DC h7

Grupo de Material de la pieza adecuado y condiciones de velocidad de corte iniciales (m/min) y código de avance alfabético. Tablas con avance por revolución a partir de la pag. 65.

P1.1 ■ 119 W	P1.2 ■ 134 W	P1.3 ■ 138 W	P2.1 ■ 102 W	P2.2 ■ 90 W	P2.3 ■ 80 V	P3.1 ■ 81 W	P3.2 ■ 65 W	P3.3 ■ 55 V	P4.1 ■ 48 W	P4.2 ■ 41 V	P4.3 ■ 34 V	M1.1 ■ 69 V	M1.2 ■ 58 V
M2.1 ■ 61 V	M2.2 ■ 50 V	K1.1 ■ 90 X	K1.2 ■ 67 X	K1.3 ■ 50 X	K2.1 ■ 80 W	K2.2 ■ 65 W	K2.3 ■ 52 W	K3.1 ■ 71 W	K3.2 ■ 54 W	K3.3 ■ 44 W	K4.1 ■ 66 W	K4.2 ■ 49 W	K4.3 ■ 36 W
K4.4 ■ 31 W	K4.5 ■ 26 W	K5.1 ■ 74 W	K5.2 ■ 56 W	K5.3 ■ 43 W	N1.1 ■ 225 Y	N1.2 ■ 169 Y	N1.3 ■ 113 Y	N2.1 ■ 231 X	N2.2 ■ 208 X	N2.3 ■ 150 X	N4.1 ■ 75 X	N4.2 ■ 115 V	S1.1 ■ 45 V
H1.1 ■ 65 T	H2.1 ■ 138 T	H2.2 ■ 36 S	H3.1 ■ 43 T	H3.2 ■ 35 T									

DCON MS tolerancia h7.

Producto	DC (inch)	DC (mm)	DC (inch)	LCF (mm)	OAL (mm)	DCON MS (mm)
R5103.0	–	3.00	0.1181	33.0	61.0	3.00
R5101/8	1/8	3.18	0.1252	36.0	65.0	3.18
R5103.2	–	3.20	0.1260	36.0	65.0	3.20
R5103.3	–	3.30	0.1299	36.0	65.0	3.30
R5103.4	–	3.40	0.1339	39.0	70.0	3.40
R5103.5	–	3.50	0.1378	39.0	70.0	3.50
R5103.7	–	3.70	0.1457	39.0	70.0	3.70
R5103.9	–	3.90	0.1535	43.0	75.0	3.90
R5104.0	–	4.00	0.1575	43.0	75.0	4.00
R5104.1	–	4.10	0.1614	43.0	75.0	4.10
R5104.2	–	4.20	0.1654	43.0	75.0	4.20
R5104.3	–	4.30	0.1693	47.0	80.0	4.30
R5104.5	–	4.50	0.1772	47.0	80.0	4.50
R5104.6	–	4.60	0.1811	47.0	80.0	4.60
R5104.7	–	4.70	0.1850	47.0	80.0	4.70
R5103/16	3/16	4.76	0.1874	52.0	86.0	4.76
R5104.9	–	4.90	0.1929	52.0	86.0	4.90
R5105.0	–	5.00	0.1969	52.0	86.0	5.00
R5105.1	–	5.10	0.2008	52.0	86.0	5.10
R5105.5	–	5.50	0.2165	57.0	93.0	5.50
R5105.6	–	5.60	0.2205	57.0	93.0	5.60
R5105.7	–	5.70	0.2244	57.0	93.0	5.70
R5106.0	–	6.00	0.2362	57.0	93.0	6.00
R5101/4	1/4	6.35	0.2500	63.0	101.0	6.35
R5106.5	–	6.50	0.2559	63.0	101.0	6.50

Producto	DC (inch)	DC (mm)	DC (inch)	LCF (mm)	OAL (mm)	DCON MS (mm)
R5106.6	–	6.60	0.2598	63.0	101.0	6.60
R5106.8	–	6.80	0.2677	69.0	109.0	6.80
R5106.9	–	6.90	0.2717	69.0	109.0	6.90
R5107.0	–	7.00	0.2756	69.0	109.0	7.00
R5107.3	–	7.30	0.2874	69.0	109.0	7.30
R5107.4	–	7.40	0.2913	69.0	109.0	7.40
R5107.5	–	7.50	0.2953	69.0	109.0	7.50
R5107.8	–	7.80	0.3071	75.0	117.0	7.80
R5107.9	–	7.90	0.3110	75.0	117.0	7.90
R5105/16	5/16	7.94	0.3126	75.0	117.0	7.94
R5108.0	–	8.00	0.3150	75.0	117.0	8.00
R5108.5	–	8.50	0.3346	75.0	117.0	8.50
R5108.7	–	8.70	0.3425	81.0	125.0	8.70
R5108.8	–	8.80	0.3465	81.0	125.0	8.80
R5109.0	–	9.00	0.3543	81.0	125.0	9.00
R5109.2	–	9.20	0.3622	81.0	125.0	9.20
R5109.3	–	9.30	0.3661	81.0	125.0	9.30
R5109.4	–	9.40	0.3701	81.0	125.0	9.40
R5109.5	–	9.50	0.3740	81.0	125.0	9.50
R5103/8	3/8	9.52	0.3748	87.0	133.0	9.52
R5109.9	–	9.90	0.3898	87.0	133.0	9.90
R51010.0	–	10.00	0.3937	87.0	133.0	10.00
R51010.2	–	10.20	0.4016	87.0	133.0	10.20
R51010.3	–	10.30	0.4055	87.0	133.0	10.30
R51010.4	–	10.40	0.4094	87.0	133.0	10.40



Producto	DC	DC	DC	LCF	OAL	DCON MS
	(inch)	(mm)	(inch)	(mm)	(mm)	(mm)
R51010.5	–	10.50	0.4134	87.0	133.0	10.50
R51010.8	–	10.80	0.4252	94.0	142.0	10.80
R51011.0	–	11.00	0.4331	94.0	142.0	11.00
R5107/16	7/16	11.11	0.4374	94.0	142.0	11.11
R51011.2	–	11.20	0.4409	94.0	142.0	11.20
R51011.5	–	11.50	0.4528	94.0	142.0	11.50

Producto	DC	DC	DC	LCF	OAL	DCON MS
	(inch)	(mm)	(inch)	(mm)	(mm)	(mm)
R51012.0	–	12.00	0.4724	101.0	151.0	12.00
R5101/2	1/2	12.70	0.5000	101.0	151.0	12.70
R51013.0	–	13.00	0.5118	101.0	151.0	13.00
R51014.0	–	14.00	0.5512	108.0	160.0	14.00
R51014.25	–	14.25	0.5610	114.0	169.0	14.25



R458



Broca FORCE X, Metal Duro 3XD, con Recubrimiento TiAlN

Broca de alto rendimiento, capaz de producir agujeros precisos y de alta calidad a altas velocidades y avances (tolerancia de agujero H9). Punta dividida de 4 facetas a 140° y alma continuamente adelgazada (CTW) para mejorar los índices de penetración. El recubrimiento TiAlN aumenta la dureza superficial y prolonga la vida de la herramienta.

FORCE X

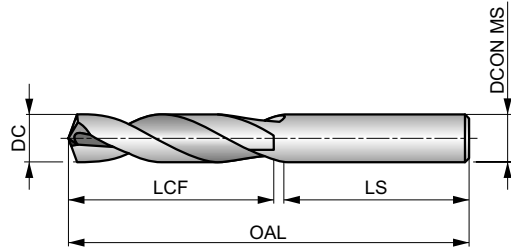

HM	DIN 6537K	3xD
140°	TiAlN	DIN 6535HA
CTW	DC m7	

Grupo de Material de la pieza adecuado y condiciones de velocidad de corte iniciales (m/min) y código de avance alfabético. Tablas con avance por revolución a partir de la pag. 65.

P1.1 ■ 143 W	P1.2 ■ 160 W	P1.3 ■ 166 W	P2.1 ■ 122 W	P2.2 ■ 108 W	P2.3 ■ 95 V	P3.1 ■ 106 V	P3.2 ■ 86 V	P3.3 ■ 72 V	P4.1 ■ 63 V	P4.2 ■ 54 V	P4.3 ■ 44 U	M1.1 ■ 60 U	M1.2 ■ 51 U
M2.1 ■ 54 U	M2.2 ■ 44 U	M2.3 ■ 37 T	M3.1 ■ 33 T	M3.2 ■ 28 T	M3.3 ■ 26 T	M4.1 ■ 24 T	M4.2 ■ 21 T	K1.1 ■ 88 W	K1.2 ■ 65 W	K1.3 ■ 49 W	K2.1 ■ 78 V	K2.2 ■ 64 V	K2.3 ■ 51 V
K3.1 ■ 70 V	K3.2 ■ 54 V	K3.3 ■ 43 V	K4.1 ■ 65 V	K4.2 ■ 49 V	K4.3 ■ 36 V	K4.4 ■ 30 V	K4.5 ■ 26 V	K5.1 ■ 73 V	K5.2 ■ 55 V	K5.3 ■ 42 V	N1.1 ■ 200 W	N1.2 ■ 150 W	N1.3 ■ 100 W
N2.1 ■ 246 V	N2.2 ■ 222 V	N2.3 ■ 160 V	N3.1 ■ 298 V	N3.2 ■ 176 V	N3.3 ■ 88 V	S1.1 ■ 44 U	S1.2 ■ 36 U	S1.3 ■ 32 T	H1.1 ■ 45 U	H2.1 ■ 26 U	H2.2 ■ 24 U	H3.1 ■ 30 U	H3.2 ■ 24 U

DCON MS tolerancia h6.

Producto	DC (inch)	DC (mm)	DC (inch)	LCF (mm)	OAL (mm)	LS (mm)	DCON MS (mm)
R4583.0	–	3.00	0.1181	20.0	62.0	36.0	6.00
R4583.1	–	3.10	0.1220	20.0	62.0	36.0	6.00
R4581/8	1/8	3.18	0.1250	20.0	62.0	36.0	6.00
R4583.2	–	3.20	0.1260	20.0	62.0	36.0	6.00
R458N30	N30	3.26	0.1283	20.0	62.0	36.0	6.00
R4583.3	–	3.30	0.1299	20.0	62.0	36.0	6.00
R4583.4	–	3.40	0.1339	20.0	62.0	36.0	6.00
R458N29	N29	3.45	0.1360	20.0	62.0	36.0	6.00
R4583.5	–	3.50	0.1378	20.0	62.0	36.0	6.00
R458N28	N28	3.57	0.1406	20.0	62.0	36.0	6.00
R4589/64	9/64	3.57	0.1406	20.0	62.0	36.0	6.00
R4583.6	–	3.60	0.1417	20.0	62.0	36.0	6.00
R458N27	N27	3.66	0.1441	20.0	62.0	36.0	6.00
R4583.7	–	3.70	0.1457	20.0	62.0	36.0	6.00
R4583.73	–	3.73	0.1469	24.0	66.0	36.0	6.00
R458N26	N26	3.73	0.1469	24.0	66.0	36.0	6.00
R458N25	N25	3.80	0.1496	24.0	66.0	36.0	6.00
R4583.8	–	3.80	0.1496	24.0	66.0	36.0	6.00
R458N24	N24	3.86	0.1520	24.0	66.0	36.0	6.00
R4583.9	–	3.90	0.1535	24.0	66.0	36.0	6.00
R458N23	N23	3.91	0.1539	24.0	66.0	36.0	6.00
R4585/32	5/32	3.97	0.1563	24.0	66.0	36.0	6.00
R458N22	N22	3.99	0.1571	24.0	66.0	36.0	6.00
R4584.0	–	4.00	0.1575	24.0	66.0	36.0	6.00
R458N21	N21	4.04	0.1591	24.0	66.0	36.0	6.00



Producto	DC	DC	DC	LCF	OAL	LS	DCON MS
	(inch)	(mm)	(inch)	(mm)	(mm)	(mm)	(mm)
R458N20	N20	4.09	0.1610	24.0	66.0	36.0	6.00
R4584.1	–	4.10	0.1614	24.0	66.0	36.0	6.00
R4584.2	–	4.20	0.1654	24.0	66.0	36.0	6.00
R458N19	N19	4.22	0.1661	24.0	66.0	36.0	6.00
R4584.3	–	4.30	0.1693	24.0	66.0	36.0	6.00
R458N18	N18	4.31	0.1697	24.0	66.0	36.0	6.00
R45811/64	11/64	4.37	0.1719	24.0	66.0	36.0	6.00
R458N17	N17	4.39	0.1728	24.0	66.0	36.0	6.00
R4584.4	–	4.40	0.1732	24.0	66.0	36.0	6.00
R4584.5	–	4.50	0.1772	24.0	66.0	36.0	6.00
R458N16	N16	4.50	0.1772	24.0	66.0	36.0	6.00
R458N15	N15	4.57	0.1799	24.0	66.0	36.0	6.00
R4584.6	–	4.60	0.1811	24.0	66.0	36.0	6.00
R458N14	N14	4.62	0.1819	24.0	66.0	36.0	6.00
R458N13	N13	4.70	0.1850	24.0	66.0	36.0	6.00
R4584.7	–	4.70	0.1850	24.0	66.0	36.0	6.00
R4583/16	3/16	4.76	0.1875	28.0	66.0	36.0	6.00
R4584.8	–	4.80	0.1890	28.0	66.0	36.0	6.00
R458N12	N12	4.80	0.1890	28.0	66.0	36.0	6.00
R458N11	N11	4.85	0.1909	28.0	66.0	36.0	6.00
R4584.9	–	4.90	0.1929	28.0	66.0	36.0	6.00
R458N10	N10	4.92	0.1937	28.0	66.0	36.0	6.00
R458N9	N9	4.98	0.1961	28.0	66.0	36.0	6.00
R4585.0	–	5.00	0.1969	28.0	66.0	36.0	6.00
R458N8	N8	5.06	0.1992	28.0	66.0	36.0	6.00
R4585.1	–	5.10	0.2008	28.0	66.0	36.0	6.00
R458N7	N7	5.11	0.2010	28.0	66.0	36.0	6.00
R45813/64	13/64	5.16	0.2031	28.0	66.0	36.0	6.00
R458N6	N6	5.18	0.2039	28.0	66.0	36.0	6.00
R4585.2	–	5.20	0.2047	28.0	66.0	36.0	6.00
R458N5	N5	5.22	0.2055	28.0	66.0	36.0	6.00
R4585.3	–	5.30	0.2087	28.0	66.0	36.0	6.00
R458N4	N4	5.31	0.2091	28.0	66.0	36.0	6.00
R4585.4	–	5.40	0.2126	28.0	66.0	36.0	6.00
R458N3	N3	5.41	0.2130	28.0	66.0	36.0	6.00
R4585.5	–	5.50	0.2165	28.0	66.0	36.0	6.00
R4587/32	7/32	5.56	0.2188	28.0	66.0	36.0	6.00
R4585.6	–	5.60	0.2205	28.0	66.0	36.0	6.00
R458N2	N2	5.61	0.2209	28.0	66.0	36.0	6.00
R4585.7	–	5.70	0.2244	28.0	66.0	36.0	6.00
R458N1	N1	5.79	0.2280	28.0	66.0	36.0	6.00
R4585.8	–	5.80	0.2283	28.0	66.0	36.0	6.00
R4585.9	–	5.90	0.2323	28.0	66.0	36.0	6.00
R458A	A	5.94	0.2339	28.0	66.0	36.0	6.00
R45815/64	15/64	5.95	0.2344	28.0	66.0	36.0	6.00
R4586.0	–	6.00	0.2362	28.0	66.0	36.0	6.00
R458B	B	6.05	0.2380	34.0	79.0	36.0	8.00
R4586.1	–	6.10	0.2402	34.0	79.0	36.0	8.00
R458C	C	6.15	0.2421	34.0	79.0	36.0	8.00
R4586.2	–	6.20	0.2441	34.0	79.0	36.0	8.00
R458D	D	6.25	0.2461	34.0	79.0	36.0	8.00
R4586.3	–	6.30	0.2480	34.0	79.0	36.0	8.00
R4581/4	1/4	6.35	0.2500	34.0	79.0	36.0	8.00
R458E	E	6.35	0.2500	34.0	79.0	36.0	8.00
R4586.4	–	6.40	0.2520	34.0	79.0	36.0	8.00
R4586.5	–	6.50	0.2559	34.0	79.0	36.0	8.00
R458F	F	6.53	0.2571	34.0	79.0	36.0	8.00
R4586.6	–	6.60	0.2598	34.0	79.0	36.0	8.00
R458G	G	6.63	0.2610	34.0	79.0	36.0	8.00
R4586.7	–	6.70	0.2638	34.0	79.0	36.0	8.00
R45817/64	17/64	6.75	0.2656	34.0	79.0	36.0	8.00
R458H	H	6.76	0.2661	34.0	79.0	36.0	8.00
R4586.8	–	6.80	0.2677	34.0	79.0	36.0	8.00
R4586.9	–	6.90	0.2717	34.0	79.0	36.0	8.00
R458I	I	6.91	0.2720	34.0	79.0	36.0	8.00



Producto	DC	DC	DC	LCF	OAL	LS	DCON MS
	(inch)	(mm)	(inch)	(mm)	(mm)	(mm)	(mm)
R4587.0	—	7.00	0.2756	34.0	79.0	36.0	8.00
R458J	J	7.04	0.2772	34.0	79.0	36.0	8.00
R4587.1	—	7.10	0.2795	41.0	79.0	36.0	8.00
R458K	K	7.14	0.2811	41.0	79.0	36.0	8.00
R4589/32	9/32	7.14	0.2813	41.0	79.0	36.0	8.00
R4587.2	—	7.20	0.2835	41.0	79.0	36.0	8.00
R4587.3	—	7.30	0.2874	41.0	79.0	36.0	8.00
R458L	L	7.37	0.2902	41.0	79.0	36.0	8.00
R4587.4	—	7.40	0.2913	41.0	79.0	36.0	8.00
R458M	M	7.49	0.2949	41.0	79.0	36.0	8.00
R4587.5	—	7.50	0.2953	41.0	79.0	36.0	8.00
R45819/64	19/64	7.54	0.2969	41.0	79.0	36.0	8.00
R4587.6	—	7.60	0.2992	41.0	79.0	36.0	8.00
R458N	N	7.67	0.3020	41.0	79.0	36.0	8.00
R4587.7	—	7.70	0.3031	41.0	79.0	36.0	8.00
R4587.8	—	7.80	0.3071	41.0	79.0	36.0	8.00
R4587.9	—	7.90	0.3110	41.0	79.0	36.0	8.00
R4585/16	5/16	7.94	0.3125	41.0	79.0	36.0	8.00
R4588.0	—	8.00	0.3150	41.0	79.0	36.0	8.00
R458O	O	8.03	0.3161	47.0	89.0	40.0	10.00
R4588.1	—	8.10	0.3189	47.0	89.0	40.0	10.00
R4588.2	—	8.20	0.3228	47.0	89.0	40.0	10.00
R458P	P	8.20	0.3228	47.0	89.0	40.0	10.00
R4588.3	—	8.30	0.3268	47.0	89.0	40.0	10.00
R45821/64	21/64	8.33	0.3281	47.0	89.0	40.0	10.00
R4588.4	—	8.40	0.3307	47.0	89.0	40.0	10.00
R458Q	Q	8.43	0.3319	47.0	89.0	40.0	10.00
R4588.5	—	8.50	0.3346	47.0	89.0	40.0	10.00
R4588.6	—	8.60	0.3386	47.0	89.0	40.0	10.00
R458R	R	8.61	0.3390	47.0	89.0	40.0	10.00
R4588.7	—	8.70	0.3425	47.0	89.0	40.0	10.00
R45811/32	11/32	8.73	0.3438	47.0	89.0	40.0	10.00
R4588.8	—	8.80	0.3465	47.0	89.0	40.0	10.00
R458S	S	8.84	0.3480	47.0	89.0	40.0	10.00
R4588.9	—	8.90	0.3504	47.0	89.0	40.0	10.00
R4589.0	—	9.00	0.3543	47.0	89.0	40.0	10.00
R458T	T	9.09	0.3579	47.0	89.0	40.0	10.00
R4589.1	—	9.10	0.3583	47.0	89.0	40.0	10.00
R45823/64	23/64	9.13	0.3594	47.0	89.0	40.0	10.00
R4589.2	—	9.20	0.3622	47.0	89.0	40.0	10.00
R4589.3	—	9.30	0.3661	47.0	89.0	40.0	10.00
R458U	U	9.35	0.3681	47.0	89.0	40.0	10.00
R4589.4	—	9.40	0.3701	47.0	89.0	40.0	10.00
R4589.5	—	9.50	0.3740	47.0	89.0	40.0	10.00
R4583/8	3/8	9.53	0.3750	47.0	89.0	40.0	10.00
R458V	V	9.58	0.3772	47.0	89.0	40.0	10.00
R4589.6	—	9.60	0.3780	47.0	89.0	40.0	10.00
R4589.7	—	9.70	0.3819	47.0	89.0	40.0	10.00
R4589.8	—	9.80	0.3858	47.0	89.0	40.0	10.00
R458W	W	9.80	0.3858	47.0	89.0	40.0	10.00
R4589.9	—	9.90	0.3898	47.0	89.0	40.0	10.00
R45825/64	25/64	9.92	0.3906	47.0	89.0	40.0	10.00
R45810.0	—	10.00	0.3937	47.0	89.0	40.0	10.00
R458X	X	10.08	0.3969	55.0	102.0	45.0	12.00
R45810.1	—	10.10	0.3976	55.0	102.0	45.0	12.00
R45810.2	—	10.20	0.4016	55.0	102.0	45.0	12.00
R458Y	Y	10.26	0.4039	55.0	102.0	45.0	12.00
R45810.3	—	10.30	0.4055	55.0	102.0	45.0	12.00
R45813/32	13/32	10.32	0.4063	55.0	102.0	45.0	12.00
R45810.4	—	10.40	0.4094	55.0	102.0	45.0	12.00
R458Z	Z	10.49	0.4130	55.0	102.0	45.0	12.00
R45810.5	—	10.50	0.4134	55.0	102.0	45.0	12.00
R45810.6	—	10.60	0.4173	55.0	102.0	45.0	12.00
R45810.7	—	10.70	0.4213	55.0	102.0	45.0	12.00
R45827/64	27/64	10.72	0.4219	55.0	102.0	45.0	12.00



Producto	DC	DC	DC	LCF	OAL	LS	DCON MS
	(inch)	(mm)	(inch)	(mm)	(mm)	(mm)	(mm)
R45810.8	–	10.80	0.4252	55.0	102.0	45.0	12.00
R45810.9	–	10.90	0.4291	55.0	102.0	45.0	12.00
R45811.0	–	11.00	0.4331	55.0	102.0	45.0	12.00
R45811.1	–	11.10	0.4370	55.0	102.0	45.0	12.00
R4587/16	7/16	11.11	0.4375	55.0	102.0	45.0	12.00
R45811.2	–	11.20	0.4409	55.0	102.0	45.0	12.00
R45811.3	–	11.30	0.4449	55.0	102.0	45.0	12.00
R45811.4	–	11.40	0.4488	55.0	102.0	45.0	12.00
R45811.5	–	11.50	0.4528	55.0	102.0	45.0	12.00
R45829/64	29/64	11.51	0.4531	55.0	102.0	45.0	12.00
R45811.6	–	11.60	0.4567	55.0	102.0	45.0	12.00
R45811.7	–	11.70	0.4606	55.0	102.0	45.0	12.00
R45811.8	–	11.80	0.4646	55.0	102.0	45.0	12.00
R45811.9	–	11.90	0.4685	55.0	102.0	45.0	12.00
R45815/32	15/32	11.91	0.4688	55.0	102.0	45.0	12.00
R45812.0	–	12.00	0.4724	55.0	102.0	45.0	12.00
R45812.1	–	12.10	0.4764	60.0	107.0	45.0	14.00
R45812.2	–	12.20	0.4803	60.0	107.0	45.0	14.00
R45831/64	31/64	12.30	0.4844	60.0	107.0	45.0	14.00
R45812.5	–	12.50	0.4921	60.0	107.0	45.0	14.00
R45812.7	–	12.70	0.5000	60.0	107.0	45.0	14.00
R4581/2	1/2	12.70	0.5000	60.0	107.0	45.0	14.00
R45812.8	–	12.80	0.5039	60.0	107.0	45.0	14.00
R45813.0	–	13.00	0.5118	60.0	107.0	45.0	14.00
R45833/64	33/64	13.10	0.5156	60.0	107.0	45.0	14.00
R45813.3	–	13.30	0.5236	60.0	107.0	45.0	14.00
R45817/32	17/32	13.49	0.5313	60.0	107.0	45.0	14.00
R45813.5	–	13.50	0.5315	60.0	107.0	45.0	14.00
R45813.8	–	13.80	0.5433	60.0	107.0	45.0	14.00
R45835/64	35/64	13.89	0.5469	60.0	107.0	45.0	14.00
R45814.0	–	14.00	0.5512	60.0	107.0	45.0	14.00
R45814.25	–	14.25	0.5610	65.0	115.0	48.0	16.00
R4589/16	9/16	14.29	0.5625	65.0	115.0	48.0	16.00
R45814.5	–	14.50	0.5709	65.0	115.0	48.0	16.00
R45837/64	37/64	14.68	0.5781	65.0	115.0	48.0	16.00
R45814.8	–	14.80	0.5827	65.0	115.0	48.0	16.00
R45815.0	–	15.00	0.5906	65.0	115.0	48.0	16.00
R45819/32	19/32	15.08	0.5938	65.0	115.0	48.0	16.00
R45815.1	–	15.10	0.5945	65.0	115.0	48.0	16.00
R45815.3	–	15.30	0.6024	65.0	115.0	48.0	16.00
R45839/64	39/64	15.48	0.6094	65.0	115.0	48.0	16.00
R45815.5	–	15.50	0.6102	65.0	115.0	48.0	16.00
R45815.8	–	15.80	0.6220	65.0	115.0	48.0	16.00
R4585/8	5/8	15.88	0.6250	65.0	115.0	48.0	16.00
R45816.0	–	16.00	0.6299	65.0	115.0	48.0	16.00
R45841/64	41/64	16.27	0.6406	73.0	123.0	48.0	18.00
R45816.5	–	16.50	0.6496	73.0	123.0	48.0	18.00
R45821/32	21/32	16.67	0.6563	73.0	123.0	48.0	18.00
R45817.0	–	17.00	0.6693	73.0	123.0	48.0	18.00
R45843/64	43/64	17.07	0.6720	73.0	123.0	48.0	18.00
R45811/16	11/16	17.46	0.6874	73.0	123.0	48.0	18.00
R45817.5	–	17.50	0.6890	73.0	123.0	48.0	18.00
R45817.8	–	17.80	0.7008	73.0	123.0	48.0	18.00
R45845/64	45/64	17.86	0.7031	73.0	123.0	48.0	18.00
R45818.0	–	18.00	0.7087	73.0	123.0	48.0	18.00
R45823/32	23/32	18.26	0.7189	79.0	131.0	50.0	20.00
R45818.5	–	18.50	0.7283	79.0	131.0	50.0	20.00
R45847/64	47/64	18.65	0.7343	79.0	131.0	50.0	20.00
R45819.0	–	19.00	0.7480	79.0	131.0	50.0	20.00
R4583/4	–	19.05	0.7500	79.0	131.0	50.0	20.00
R45819.5	–	19.50	0.7677	79.0	131.0	50.0	20.00
R45819.8	–	19.80	0.7795	79.0	131.0	50.0	20.00
R45820.0	–	20.00	0.7874	79.0	131.0	50.0	20.00



R457



Broca FORCE X, Metal Duro 3XD, con Refrigeración Interna, con Recubrimiento TiAlN

Broca de alto rendimiento, capaz de producir agujeros precisos y de alta calidad a altas velocidades y avances (tolerancia de agujero H9). Punta dividida de 4 facetas a 140° y alma continuamente adelgazada (CTW) para mejorar los índices de penetración. Los agujeros de refrigeración permiten mejorar la evacuación de virutas. El recubrimiento TiAlN aumenta la dureza superficial y prolonga la vida de la herramienta.

FORCE X

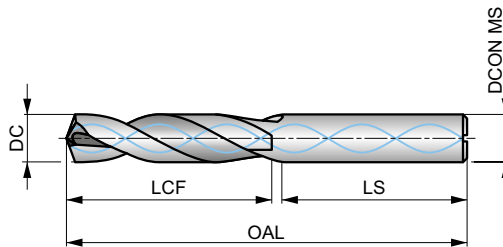

HM	DIN 6537K	3xD
140°	TiAlN	DIN 6535HA
CTW	DC m7	

Grupo de Material de la pieza adecuado y condiciones de velocidad de corte iniciales (m/min) y código de avance alfabético. Tablas con avance por revolución a partir de la pag. 65.

P1.1 ■ 179 W	P1.2 ■ 200 W	P1.3 ■ 207 W	P2.1 ■ 153 W	P2.2 ■ 135 W	P2.3 ■ 119 V	P3.1 ■ 133 V	P3.2 ■ 107 V	P3.3 ■ 90 V	P4.1 ■ 79 V	P4.2 ■ 67 V	P4.3 ■ 55 U	M1.1 ■ 75 V	M1.2 ■ 64 V
M2.1 ■ 67 V	M2.2 ■ 55 V	M2.3 ■ 46 U	M3.1 ■ 41 V	M3.2 ■ 35 V	M3.3 ■ 32 V	M4.1 ■ 30 U	M4.2 ■ 26 U	K1.1 ■ 110 W	K1.2 ■ 81 W	K1.3 ■ 61 W	K2.1 ■ 98 V	K2.2 ■ 80 V	K2.3 ■ 64 V
K3.1 ■ 87 V	K3.2 ■ 67 V	K3.3 ■ 54 V	K4.1 ■ 81 V	K4.2 ■ 61 V	K4.3 ■ 45 V	K4.4 ■ 38 V	K4.5 ■ 32 V	K5.1 ■ 91 V	K5.2 ■ 69 V	K5.3 ■ 53 V	N1.1 ■ 250 W	N1.2 ■ 188 W	N1.3 ■ 125 W
N2.1 ■ 308 V	N2.2 ■ 277 V	N2.3 ■ 200 V	N3.1 ■ 373 W	N3.2 ■ 220 W	N3.3 ■ 110 W	S1.1 ■ 55 V	S1.2 ■ 45 V	S1.3 ■ 40 U	H1.1 ■ 56 U	H2.1 ■ 33 U	H2.2 ■ 30 U	H3.1 ■ 37 U	H3.2 ■ 30 U

DCON MS tolerancia h6.

Producto	DC (inch)	DC (mm)	DC (inch)	LCF (mm)	OAL (mm)	LS (mm)	DCON MS (mm)
R4573.0	—	3.00	0.1181	20.0	62.0	36.0	6.00
R4573.1	—	3.10	0.1220	20.0	62.0	36.0	6.00
R4571/8	1/8	3.18	0.1250	20.0	62.0	36.0	6.00
R4573.2	—	3.20	0.1260	20.0	62.0	36.0	6.00
R457N30	N30	3.26	0.1283	20.0	62.0	36.0	6.00
R4573.3	—	3.30	0.1299	20.0	62.0	36.0	6.00
R4573.4	—	3.40	0.1339	20.0	62.0	36.0	6.00
R457N29	N29	3.45	0.1360	20.0	62.0	36.0	6.00
R4573.5	—	3.50	0.1378	20.0	62.0	36.0	6.00
R457N28	N28	3.57	0.1406	20.0	62.0	36.0	6.00
R4579/64	9/64	3.57	0.1406	20.0	62.0	36.0	6.00
R4573.6	—	3.60	0.1417	20.0	62.0	36.0	6.00
R457N27	N27	3.66	0.1441	20.0	62.0	36.0	6.00
R4573.7	—	3.70	0.1457	20.0	62.0	36.0	6.00
R457N26	N26	3.73	0.1469	24.0	66.0	36.0	6.00
R457N25	N25	3.80	0.1496	24.0	66.0	36.0	6.00
R4573.8	—	3.80	0.1496	24.0	66.0	36.0	6.00
R457N24	N24	3.86	0.1520	24.0	66.0	36.0	6.00
R4573.9	—	3.90	0.1535	24.0	66.0	36.0	6.00
R457N23	N23	3.91	0.1539	24.0	66.0	36.0	6.00
R4575/32	5/32	3.97	0.1563	24.0	66.0	36.0	6.00
R457N22	N22	3.99	0.1571	24.0	66.0	36.0	6.00
R4574.0	—	4.00	0.1575	24.0	66.0	36.0	6.00
R457N21	N21	4.04	0.1591	24.0	66.0	36.0	6.00
R4574.05	—	4.05	0.1594	24.0	66.0	36.0	6.00



Producto	DC	DC	DC	LCF	OAL	LS	DCON MS
	(inch)	(mm)	(inch)	(mm)	(mm)	(mm)	(mm)
R457N20	N20	4.09	0.1610	24.0	66.0	36.0	6.00
R4574.1	–	4.10	0.1614	24.0	66.0	36.0	6.00
R4574.2	–	4.20	0.1654	24.0	66.0	36.0	6.00
R457N19	N19	4.22	0.1661	24.0	66.0	36.0	6.00
R4574.3	–	4.30	0.1693	24.0	66.0	36.0	6.00
R457N18	N18	4.31	0.1697	24.0	66.0	36.0	6.00
R45711/64	11/64	4.37	0.1719	24.0	66.0	36.0	6.00
R457N17	N17	4.39	0.1728	24.0	66.0	36.0	6.00
R4574.4	–	4.40	0.1732	24.0	66.0	36.0	6.00
R4574.5	–	4.50	0.1772	24.0	66.0	36.0	6.00
R457N16	N16	4.50	0.1772	24.0	66.0	36.0	6.00
R457N15	N15	4.57	0.1799	24.0	66.0	36.0	6.00
R4574.6	–	4.60	0.1811	24.0	66.0	36.0	6.00
R457N14	N14	4.62	0.1819	24.0	66.0	36.0	6.00
R457N13	N13	4.70	0.1850	24.0	66.0	36.0	6.00
R4574.7	–	4.70	0.1850	24.0	66.0	36.0	6.00
R4573/16	3/16	4.76	0.1875	28.0	66.0	36.0	6.00
R4574.8	–	4.80	0.1890	28.0	66.0	36.0	6.00
R457N12	N12	4.80	0.1890	28.0	66.0	36.0	6.00
R457N11	N11	4.85	0.1909	28.0	66.0	36.0	6.00
R4574.9	–	4.90	0.1929	28.0	66.0	36.0	6.00
R457N10	N10	4.92	0.1937	28.0	66.0	36.0	6.00
R457N9	N9	4.98	0.1961	28.0	66.0	36.0	6.00
R4575.0	–	5.00	0.1969	28.0	66.0	36.0	6.00
R4575.05	–	5.05	0.1988	28.0	66.0	36.0	6.00
R457N8	N8	5.06	0.1992	28.0	66.0	36.0	6.00
R4575.1	–	5.10	0.2008	28.0	66.0	36.0	6.00
R457N7	N7	5.11	0.2010	28.0	66.0	36.0	6.00
R45713/64	13/64	5.16	0.2031	28.0	66.0	36.0	6.00
R457N6	N6	5.18	0.2039	28.0	66.0	36.0	6.00
R4575.2	–	5.20	0.2047	28.0	66.0	36.0	6.00
R457N5	N5	5.22	0.2055	28.0	66.0	36.0	6.00
R4575.3	–	5.30	0.2087	28.0	66.0	36.0	6.00
R457N4	N4	5.31	0.2091	28.0	66.0	36.0	6.00
R4575.4	–	5.40	0.2126	28.0	66.0	36.0	6.00
R457N3	N3	5.41	0.2130	28.0	66.0	36.0	6.00
R4575.5	–	5.50	0.2165	28.0	66.0	36.0	6.00
R4577/32	7/32	5.56	0.2188	28.0	66.0	36.0	6.00
R4575.6	–	5.60	0.2205	28.0	66.0	36.0	6.00
R457N2	N2	5.61	0.2209	28.0	66.0	36.0	6.00
R4575.7	–	5.70	0.2244	28.0	66.0	36.0	6.00
R457N1	N1	5.79	0.2280	28.0	66.0	36.0	6.00
R4575.8	–	5.80	0.2283	28.0	66.0	36.0	6.00
R4575.9	–	5.90	0.2323	28.0	66.0	36.0	6.00
R457A	A	5.94	0.2339	28.0	66.0	36.0	6.00
R45715/64	15/64	5.95	0.2344	28.0	66.0	36.0	6.00
R4576.0	–	6.00	0.2362	28.0	66.0	36.0	6.00
R457B	B	6.05	0.2380	34.0	79.0	36.0	8.00
R4576.05	–	6.05	0.2382	34.0	79.0	36.0	8.00
R4576.1	–	6.10	0.2402	34.0	79.0	36.0	8.00
R457C	C	6.15	0.2421	34.0	79.0	36.0	8.00
R4576.2	–	6.20	0.2441	34.0	79.0	36.0	8.00
R457D	D	6.25	0.2461	34.0	79.0	36.0	8.00
R4576.3	–	6.30	0.2480	34.0	79.0	36.0	8.00
R4571/4	1/4	6.35	0.2500	34.0	79.0	36.0	8.00
R457E	E	6.35	0.2500	34.0	79.0	36.0	8.00
R4576.4	–	6.40	0.2520	34.0	79.0	36.0	8.00
R4576.5	–	6.50	0.2559	34.0	79.0	36.0	8.00
R457F	F	6.53	0.2571	34.0	79.0	36.0	8.00
R4576.6	–	6.60	0.2598	34.0	79.0	36.0	8.00
R457G	G	6.63	0.2610	34.0	79.0	36.0	8.00
R4576.7	–	6.70	0.2638	34.0	79.0	36.0	8.00
R45717/64	17/64	6.75	0.2656	34.0	79.0	36.0	8.00
R457H	H	6.76	0.2661	34.0	79.0	36.0	8.00
R4576.8	–	6.80	0.2677	34.0	79.0	36.0	8.00



Producto	DC	DC	DC	LCF	OAL	LS	DCON MS
	(inch)	(mm)	(inch)	(mm)	(mm)	(mm)	(mm)
R4576.9	—	6.90	0.2717	34.0	79.0	36.0	8.00
R457I	I	6.91	0.2720	34.0	79.0	36.0	8.00
R4577.0	—	7.00	0.2756	34.0	79.0	36.0	8.00
R457J	J	7.04	0.2772	41.0	79.0	36.0	8.00
R4577.1	—	7.10	0.2795	41.0	79.0	36.0	8.00
R457K	K	7.14	0.2811	41.0	79.0	36.0	8.00
R4579/32	9/32	7.14	0.2813	41.0	79.0	36.0	8.00
R4577.2	—	7.20	0.2835	41.0	79.0	36.0	8.00
R4577.3	—	7.30	0.2874	41.0	79.0	36.0	8.00
R457L	L	7.37	0.2902	41.0	79.0	36.0	8.00
R4577.4	—	7.40	0.2913	41.0	79.0	36.0	8.00
R457M	M	7.49	0.2949	41.0	79.0	36.0	8.00
R4577.5	—	7.50	0.2953	41.0	79.0	36.0	8.00
R45719/64	19/64	7.54	0.2969	41.0	79.0	36.0	8.00
R4577.6	—	7.60	0.2992	41.0	79.0	36.0	8.00
R457N	N	7.67	0.3020	41.0	79.0	36.0	8.00
R4577.7	—	7.70	0.3031	41.0	79.0	36.0	8.00
R4577.8	—	7.80	0.3071	41.0	79.0	36.0	8.00
R4577.9	—	7.90	0.3110	41.0	79.0	36.0	8.00
R4575/16	5/16	7.94	0.3125	41.0	79.0	36.0	8.00
R4578.0	—	8.00	0.3150	41.0	79.0	36.0	8.00
R457O	O	8.03	0.3161	47.0	89.0	40.0	10.00
R4578.05	—	8.05	0.3169	47.0	89.0	40.0	10.00
R4578.1	—	8.10	0.3189	47.0	89.0	40.0	10.00
R4578.2	—	8.20	0.3228	47.0	89.0	40.0	10.00
R457P	P	8.20	0.3228	47.0	89.0	40.0	10.00
R4578.3	—	8.30	0.3268	47.0	89.0	40.0	10.00
R45721/64	21/64	8.33	0.3281	47.0	89.0	40.0	10.00
R4578.4	—	8.40	0.3307	47.0	89.0	40.0	10.00
R457Q	Q	8.43	0.3319	47.0	89.0	40.0	10.00
R4578.5	—	8.50	0.3346	47.0	89.0	40.0	10.00
R4578.6	—	8.60	0.3386	47.0	89.0	40.0	10.00
R457R	R	8.61	0.3390	47.0	89.0	40.0	10.00
R4578.7	—	8.70	0.3425	47.0	89.0	40.0	10.00
R45711/32	11/32	8.73	0.3438	47.0	89.0	40.0	10.00
R4578.8	—	8.80	0.3465	47.0	89.0	40.0	10.00
R457S	S	8.84	0.3480	47.0	89.0	40.0	10.00
R4578.9	—	8.90	0.3504	47.0	89.0	40.0	10.00
R4579.0	—	9.00	0.3543	47.0	89.0	40.0	10.00
R457T	T	9.09	0.3579	47.0	89.0	40.0	10.00
R4579.1	—	9.10	0.3583	47.0	89.0	40.0	10.00
R45723/64	23/64	9.13	0.3594	47.0	89.0	40.0	10.00
R4579.2	—	9.20	0.3622	47.0	89.0	40.0	10.00
R4579.3	—	9.30	0.3661	47.0	89.0	40.0	10.00
R457U	U	9.35	0.3681	47.0	89.0	40.0	10.00
R4579.4	—	9.40	0.3701	47.0	89.0	40.0	10.00
R4579.5	—	9.50	0.3740	47.0	89.0	40.0	10.00
R4573/8	3/8	9.53	0.3750	47.0	89.0	40.0	10.00
R457V	V	9.58	0.3772	47.0	89.0	40.0	10.00
R4579.6	—	9.60	0.3780	47.0	89.0	40.0	10.00
R4579.7	—	9.70	0.3819	47.0	89.0	40.0	10.00
R4579.8	—	9.80	0.3858	47.0	89.0	40.0	10.00
R457W	W	9.80	0.3858	47.0	89.0	40.0	10.00
R4579.9	—	9.90	0.3898	47.0	89.0	40.0	10.00
R45725/64	25/64	9.92	0.3906	47.0	89.0	40.0	10.00
R45710.0	—	10.00	0.3937	47.0	89.0	40.0	10.00
R45710.05	—	10.05	0.3957	55.0	102.0	45.0	12.00
R457X	X	10.08	0.3969	55.0	102.0	45.0	12.00
R45710.1	—	10.10	0.3976	55.0	102.0	45.0	12.00
R45710.2	—	10.20	0.4016	55.0	102.0	45.0	12.00
R457Y	Y	10.26	0.4039	55.0	102.0	45.0	12.00
R45710.3	—	10.30	0.4055	55.0	102.0	45.0	12.00
R45713/32	13/32	10.32	0.4063	55.0	102.0	45.0	12.00
R45710.4	—	10.40	0.4094	55.0	102.0	45.0	12.00
R457Z	Z	10.49	0.4130	55.0	102.0	45.0	12.00



Producto	DC	DC	DC	LCF	OAL	LS	DCON MS
	(inch)	(mm)	(inch)	(mm)	(mm)	(mm)	(mm)
R45710.5	–	10.50	0.4134	55.0	102.0	45.0	12.00
R45710.6	–	10.60	0.4173	55.0	102.0	45.0	12.00
R45727/64	27/64	10.72	0.4219	55.0	102.0	45.0	12.00
R45710.8	–	10.80	0.4252	55.0	102.0	45.0	12.00
R45711.0	–	11.00	0.4331	55.0	102.0	45.0	12.00
R4577/16	7/16	11.11	0.4375	55.0	102.0	45.0	12.00
R45711.2	–	11.20	0.4409	55.0	102.0	45.0	12.00
R45711.3	–	11.30	0.4449	55.0	102.0	45.0	12.00
R45711.4	–	11.40	0.4488	55.0	102.0	45.0	12.00
R45711.5	–	11.50	0.4528	55.0	102.0	45.0	12.00
R45729/64	29/64	11.51	0.4531	55.0	102.0	45.0	12.00
R45711.6	–	11.60	0.4567	55.0	102.0	45.0	12.00
R45711.8	–	11.80	0.4646	55.0	102.0	45.0	12.00
R45715/32	15/32	11.91	0.4688	55.0	102.0	45.0	12.00
R45712.0	–	12.00	0.4724	55.0	102.0	45.0	12.00
R45712.05	–	12.05	0.4744	60.0	107.0	45.0	14.00
R45712.1	–	12.10	0.4764	60.0	107.0	45.0	14.00
R45712.2	–	12.20	0.4803	60.0	107.0	45.0	14.00
R45731/64	31/64	12.30	0.4844	60.0	107.0	45.0	14.00
R45712.5	–	12.50	0.4921	60.0	107.0	45.0	14.00
R45712.7	–	12.70	0.5000	60.0	107.0	45.0	14.00
R4571/2	1/2	12.70	0.5000	60.0	107.0	45.0	14.00
R45712.8	–	12.80	0.5039	60.0	107.0	45.0	14.00
R45713.0	–	13.00	0.5118	60.0	107.0	45.0	14.00
R45733/64	33/64	13.10	0.5156	60.0	107.0	45.0	14.00
R45713.3	–	13.30	0.5236	60.0	107.0	45.0	14.00
R45717/32	17/32	13.49	0.5313	60.0	107.0	45.0	14.00
R45713.5	–	13.50	0.5315	60.0	107.0	45.0	14.00
R45713.8	–	13.80	0.5433	60.0	107.0	45.0	14.00
R45735/64	35/64	13.89	0.5469	60.0	107.0	45.0	14.00
R45714.0	–	14.00	0.5512	60.0	107.0	45.0	14.00
R45714.25	–	14.25	0.5610	65.0	115.0	48.0	16.00
R4579/16	9/16	14.29	0.5625	65.0	115.0	48.0	16.00
R45714.5	–	14.50	0.5709	65.0	115.0	48.0	16.00
R45737/64	37/64	14.68	0.5781	65.0	115.0	48.0	16.00
R45714.8	–	14.80	0.5827	65.0	115.0	48.0	16.00
R45715.0	–	15.00	0.5906	65.0	115.0	48.0	16.00
R45719/32	19/32	15.08	0.5938	65.0	115.0	48.0	16.00
R45715.1	–	15.10	0.5945	65.0	115.0	48.0	16.00
R45715.3	–	15.30	0.6024	65.0	115.0	48.0	16.00
R45739/64	39/64	15.48	0.6094	65.0	115.0	48.0	16.00
R45715.5	–	15.50	0.6102	65.0	115.0	48.0	16.00
R45715.8	–	15.80	0.6220	65.0	115.0	48.0	16.00
R4575/8	5/8	15.88	0.6250	65.0	115.0	48.0	16.00
R45716.0	–	16.00	0.6299	65.0	115.0	48.0	16.00
R45741/64	41/64	16.27	0.6406	73.0	123.0	48.0	18.00
R45716.5	–	16.50	0.6496	73.0	123.0	48.0	18.00
R45721/32	21/32	16.67	0.6563	73.0	123.0	48.0	18.00
R45717.0	–	17.00	0.6693	73.0	123.0	48.0	18.00
R45743/64	43/64	17.07	0.6720	73.0	123.0	48.0	18.00
R45711/16	11/16	17.46	0.6874	73.0	123.0	48.0	18.00
R45717.5	–	17.50	0.6890	73.0	123.0	48.0	18.00
R45745/64	45/64	17.86	0.7031	73.0	123.0	48.0	18.00
R45718.0	–	18.00	0.7087	73.0	123.0	48.0	18.00
R45723/32	23/32	18.26	0.7189	79.0	131.0	50.0	20.00
R45718.5	–	18.50	0.7283	79.0	131.0	50.0	20.00
R45747/64	47/64	18.65	0.7343	79.0	131.0	50.0	20.00
R45718.8	–	18.80	0.7402	79.0	131.0	50.0	20.00
R45719.0	–	19.00	0.7480	79.0	131.0	50.0	20.00
R4573/4	3/4	19.05	0.7500	79.0	131.0	50.0	20.00
R45719.5	–	19.50	0.7677	79.0	131.0	50.0	20.00
R45719.8	–	19.80	0.7795	79.0	131.0	50.0	20.00
R45720.0	–	20.00	0.7874	79.0	131.0	50.0	20.00



R454



Broca FORCE X, Metal Duro 5XD, con Recubrimiento TiAlN

Broca de alto rendimiento, capaz de producir agujeros precisos y de alta calidad a altas velocidades y avances (tolerancia de agujero H9). Punta dividida de 4 facetas a 140° y alma continuamente adelgazada (CTW) para mejorar los índices de penetración. El recubrimiento TiAlN aumenta la dureza superficial y prolonga la vida de la herramienta.

FORCE X

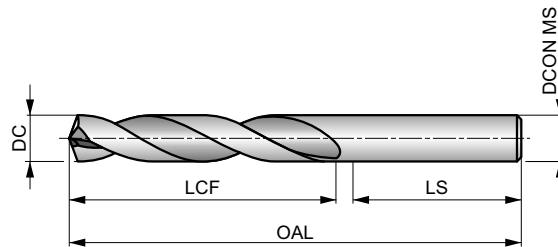

HM	DIN 6537L	5xD
140°	TiAlN	DIN 6535HA
CTW	DC m7	

Grupo de Material de la pieza adecuado y condiciones de velocidad de corte iniciales (m/min) y código de avance alfabético. Tablas con avance por revolución a partir de la pag. 65.

P1.1 ■ 134 V	P1.2 ■ 150 V	P1.3 ■ 155 V	P2.1 ■ 115 V	P2.2 ■ 101 V	P2.3 ■ 89 V	P3.1 ■ 100 V	P3.2 ■ 80 V	P3.3 ■ 68 V	P4.1 ■ 59 V	P4.2 ■ 50 V	P4.3 ■ 41 U	M1.1 ▣ 56 U	M1.2 ▣ 48 U
M2.1 ▣ 50 U	M2.2 ▣ 41 U	M2.3 ▣ 35 T	M3.1 ▣ 31 T	M3.2 ▣ 26 T	M3.3 ▣ 24 T	M4.1 ▣ 23 T	M4.2 ▣ 20 T	K1.1 ■ 83 W	K1.2 ■ 61 W	K1.3 ■ 46 W	K2.1 ■ 74 V	K2.2 ■ 60 V	K2.3 ■ 48 V
K3.1 ■ 65 V	K3.2 ■ 50 V	K3.3 ■ 41 V	K4.1 ■ 61 V	K4.2 ■ 46 V	K4.3 ■ 34 V	K4.4 ■ 29 V	K4.5 ■ 24 V	K5.1 ■ 68 V	K5.2 ■ 52 V	K5.3 ■ 40 V	N1.1 ■ 188 W	N1.2 ■ 141 W	N1.3 ■ 94 W
N2.1 ■ 231 V	N2.2 ■ 208 V	N2.3 ■ 150 V	N3.1 ■ 280 V	N3.2 ■ 165 V	N3.3 ■ 83 V	S1.1 ▣ 41 U	S1.2 ▣ 34 U	S1.3 ▣ 30 T	H1.1 ■ 42 U	H2.1 ▣ 25 U	H2.2 ▣ 23 U	H3.1 ▣ 28 U	H3.2 ▣ 23 U

DCON MS tolerancia h6.

Producto	DC (inch)	DC (mm)	DC (inch)	LCF (mm)	OAL (mm)	LS (mm)	DCON MS (mm)
R4543.0	—	3.00	0.1181	28.0	66.0	36.0	6.00
R4543.1	—	3.10	0.1220	28.0	66.0	36.0	6.00
R4541/8	1/8	3.18	0.1250	28.0	66.0	36.0	6.00
R4543.2	—	3.20	0.1260	28.0	66.0	36.0	6.00
R454N30	N30	3.26	0.1283	28.0	66.0	36.0	6.00
R4543.3	—	3.30	0.1299	28.0	66.0	36.0	6.00
R4543.4	—	3.40	0.1339	28.0	66.0	36.0	6.00
R454N29	N29	3.45	0.1360	28.0	66.0	36.0	6.00
R4543.5	—	3.50	0.1378	28.0	66.0	36.0	6.00
R454N28	N28	3.57	0.1406	28.0	66.0	36.0	6.00
R4549/64	9/64	3.57	0.1406	28.0	66.0	36.0	6.00
R4543.6	—	3.60	0.1417	28.0	66.0	36.0	6.00
R454N27	N27	3.66	0.1441	28.0	66.0	36.0	6.00
R4543.7	—	3.70	0.1457	28.0	66.0	36.0	6.00
R454N26	N26	3.73	0.1469	36.0	74.0	36.0	6.00
R454N25	N25	3.80	0.1496	36.0	74.0	36.0	6.00
R4543.8	—	3.80	0.1496	36.0	74.0	36.0	6.00
R454N24	N24	3.86	0.1520	36.0	74.0	36.0	6.00
R4543.9	—	3.90	0.1535	36.0	74.0	36.0	6.00
R454N23	N23	3.91	0.1539	36.0	74.0	36.0	6.00
R4545/32	5/32	3.97	0.1563	36.0	74.0	36.0	6.00
R454N22	N22	3.99	0.1571	36.0	74.0	36.0	6.00
R4544.0	—	4.00	0.1575	36.0	74.0	36.0	6.00
R454N21	N21	4.04	0.1591	36.0	74.0	36.0	6.00
R454N20	N20	4.09	0.1610	36.0	74.0	36.0	6.00



Producto	DC	DC	DC	LCF	OAL	LS	DCON MS
	(inch)	(mm)	(inch)	(mm)	(mm)	(mm)	(mm)
R4544.1	–	4.10	0.1614	36.0	74.0	36.0	6.00
R4544.2	–	4.20	0.1654	36.0	74.0	36.0	6.00
R454N19	N19	4.22	0.1661	36.0	74.0	36.0	6.00
R4544.3	–	4.30	0.1693	36.0	74.0	36.0	6.00
R454N18	N18	4.31	0.1697	36.0	74.0	36.0	6.00
R45411/64	11/64	4.37	0.1719	36.0	74.0	36.0	6.00
R454N17	N17	4.39	0.1728	36.0	74.0	36.0	6.00
R4544.4	–	4.40	0.1732	36.0	74.0	36.0	6.00
R4544.5	–	4.50	0.1772	36.0	74.0	36.0	6.00
R454N16	N16	4.50	0.1772	36.0	74.0	36.0	6.00
R454N15	N15	4.57	0.1799	36.0	74.0	36.0	6.00
R4544.6	–	4.60	0.1811	36.0	74.0	36.0	6.00
R454N14	N14	4.62	0.1819	36.0	74.0	36.0	6.00
R454N13	N13	4.70	0.1850	36.0	74.0	36.0	6.00
R4544.7	–	4.70	0.1850	36.0	74.0	36.0	6.00
R4543/16	3/16	4.76	0.1875	44.0	82.0	36.0	6.00
R454N12	N12	4.80	0.1890	44.0	82.0	36.0	6.00
R4544.8	–	4.80	0.1890	44.0	82.0	36.0	6.00
R454N11	N11	4.85	0.1909	44.0	82.0	36.0	6.00
R4544.9	–	4.90	0.1929	44.0	82.0	36.0	6.00
R454N10	N10	4.92	0.1937	44.0	82.0	36.0	6.00
R454N9	N9	4.98	0.1961	44.0	82.0	36.0	6.00
R4545.0	–	5.00	0.1969	44.0	82.0	36.0	6.00
R454N8	N8	5.06	0.1992	44.0	82.0	36.0	6.00
R4545.1	–	5.10	0.2008	44.0	82.0	36.0	6.00
R454N7	N7	5.11	0.2010	44.0	82.0	36.0	6.00
R45413/64	13/64	5.16	0.2031	44.0	82.0	36.0	6.00
R454N6	N6	5.18	0.2039	44.0	82.0	36.0	6.00
R4545.2	–	5.20	0.2047	44.0	82.0	36.0	6.00
R454N5	N5	5.22	0.2055	44.0	82.0	36.0	6.00
R454N4	N4	5.31	0.2091	44.0	82.0	36.0	6.00
R454N3	N3	5.41	0.2130	44.0	82.0	36.0	6.00
R4545.5	–	5.50	0.2165	44.0	82.0	36.0	6.00
R4547/32	7/32	5.56	0.2188	44.0	82.0	36.0	6.00
R4545.6	–	5.60	0.2205	44.0	82.0	36.0	6.00
R454N2	N2	5.61	0.2209	44.0	82.0	36.0	6.00
R4545.7	–	5.70	0.2244	44.0	82.0	36.0	6.00
R454N1	N1	5.79	0.2280	44.0	82.0	36.0	6.00
R4545.8	–	5.80	0.2283	44.0	82.0	36.0	6.00
R454A	A	5.94	0.2339	44.0	82.0	36.0	6.00
R45415/64	15/64	5.95	0.2344	44.0	82.0	36.0	6.00
R4546.0	–	6.00	0.2362	44.0	82.0	36.0	6.00
R454B	B	6.05	0.2380	53.0	91.0	36.0	8.00
R4546.1	–	6.10	0.2402	53.0	91.0	36.0	8.00
R454C	C	6.15	0.2421	53.0	91.0	36.0	8.00
R4546.2	–	6.20	0.2441	53.0	91.0	36.0	8.00
R454D	D	6.25	0.2461	53.0	91.0	36.0	8.00
R4546.3	–	6.30	0.2480	53.0	91.0	36.0	8.00
R4541/4	1/4	6.35	0.2500	53.0	91.0	36.0	8.00
R454E	E	6.35	0.2500	53.0	91.0	36.0	8.00
R4546.4	–	6.40	0.2520	53.0	91.0	36.0	8.00
R4546.5	–	6.50	0.2559	53.0	91.0	36.0	8.00
R454F	F	6.53	0.2571	53.0	91.0	36.0	8.00
R4546.6	–	6.60	0.2598	53.0	91.0	36.0	8.00
R454G	G	6.63	0.2610	53.0	91.0	36.0	8.00
R4546.7	–	6.70	0.2638	53.0	91.0	36.0	8.00
R45417/64	17/64	6.75	0.2656	53.0	91.0	36.0	8.00
R454H	H	6.76	0.2661	53.0	91.0	36.0	8.00
R4546.8	–	6.80	0.2677	53.0	91.0	36.0	8.00
R4546.9	–	6.90	0.2717	53.0	91.0	36.0	8.00
R454I	I	6.91	0.2720	53.0	91.0	36.0	8.00
R4547.0	–	7.00	0.2756	53.0	91.0	36.0	8.00



Producto	DC	DC	DC	LCF	OAL	LS	DCON MS
	(inch)	(mm)	(inch)	(mm)	(mm)	(mm)	(mm)
R454J	J	7.04	0.2772	53.0	91.0	36.0	8.00
R4547.1	—	7.10	0.2795	53.0	91.0	36.0	8.00
R454K	K	7.14	0.2811	53.0	91.0	36.0	8.00
R4549/32	9/32	7.14	0.2813	53.0	91.0	36.0	8.00
R4547.3	—	7.30	0.2874	53.0	91.0	36.0	8.00
R454L	L	7.37	0.2902	53.0	91.0	36.0	8.00
R4547.4	—	7.40	0.2913	53.0	91.0	36.0	8.00
R454M	M	7.49	0.2949	53.0	91.0	36.0	8.00
R4547.5	—	7.50	0.2953	53.0	91.0	36.0	8.00
R45419/64	19/64	7.54	0.2969	53.0	91.0	36.0	8.00
R4547.6	—	7.60	0.2992	53.0	91.0	36.0	8.00
R454N	N	7.67	0.3020	53.0	91.0	36.0	8.00
R4547.7	—	7.70	0.3031	53.0	91.0	36.0	8.00
R4547.8	—	7.80	0.3071	53.0	91.0	36.0	8.00
R4547.9	—	7.90	0.3110	53.0	91.0	36.0	8.00
R4545/16	5/16	7.94	0.3125	53.0	91.0	36.0	8.00
R4548.0	—	8.00	0.3150	53.0	91.0	36.0	8.00
R4540	O	8.03	0.3161	61.0	103.0	40.0	10.00
R4548.1	—	8.10	0.3189	61.0	103.0	40.0	10.00
R4548.2	—	8.20	0.3228	61.0	103.0	40.0	10.00
R454P	P	8.20	0.3228	61.0	103.0	40.0	10.00
R45421/64	21/64	8.33	0.3281	61.0	103.0	40.0	10.00
R4548.4	—	8.40	0.3307	61.0	103.0	40.0	10.00
R454Q	Q	8.43	0.3319	61.0	103.0	40.0	10.00
R4548.5	—	8.50	0.3346	61.0	103.0	40.0	10.00
R4548.6	—	8.60	0.3386	61.0	103.0	40.0	10.00
R454R	R	8.61	0.3390	61.0	103.0	40.0	10.00
R4548.7	—	8.70	0.3425	61.0	103.0	40.0	10.00
R45411/32	11/32	8.73	0.3438	61.0	103.0	40.0	10.00
R4548.8	—	8.80	0.3465	61.0	103.0	40.0	10.00
R454S	S	8.84	0.3480	61.0	103.0	40.0	10.00
R4548.9	—	8.90	0.3504	61.0	103.0	40.0	10.00
R4549.0	—	9.00	0.3543	61.0	103.0	40.0	10.00
R454T	T	9.09	0.3579	61.0	103.0	40.0	10.00
R4549.1	—	9.10	0.3583	61.0	103.0	40.0	10.00
R45423/64	23/64	9.13	0.3594	61.0	103.0	40.0	10.00
R4549.3	—	9.30	0.3661	61.0	103.0	40.0	10.00
R454U	U	9.35	0.3681	61.0	103.0	40.0	10.00
R4549.4	—	9.40	0.3701	61.0	103.0	40.0	10.00
R4549.5	—	9.50	0.3740	61.0	103.0	40.0	10.00
R4543/8	3/8	9.53	0.3750	61.0	103.0	40.0	10.00
R454V	V	9.58	0.3772	61.0	103.0	40.0	10.00
R4549.6	—	9.60	0.3780	61.0	103.0	40.0	10.00
R4549.7	—	9.70	0.3819	61.0	103.0	40.0	10.00
R4549.8	—	9.80	0.3858	61.0	103.0	40.0	10.00
R4549.9	—	9.90	0.3898	61.0	103.0	40.0	10.00
R454W	W	9.80	0.3858	61.0	103.0	40.0	10.00
R45425/64	25/64	9.92	0.3906	61.0	103.0	40.0	10.00
R45410.0	—	10.00	0.3937	61.0	103.0	40.0	10.00
R454X	X	10.08	0.3969	70.0	118.0	45.0	12.00
R45410.1	—	10.10	0.3976	70.0	118.0	45.0	12.00
R45410.2	—	10.20	0.4016	70.0	118.0	45.0	12.00
R454Y	Y	10.26	0.4039	70.0	118.0	45.0	12.00
R45410.3	—	10.30	0.4055	70.0	118.0	45.0	12.00
R45413/32	13/32	10.32	0.4063	70.0	118.0	45.0	12.00
R45410.4	—	10.40	0.4094	70.0	118.0	45.0	12.00
R454Z	Z	10.49	0.4130	70.0	118.0	45.0	12.00
R45410.5	—	10.50	0.4134	70.0	118.0	45.0	12.00
R45410.6	—	10.60	0.4173	70.0	118.0	45.0	12.00
R45427/64	27/64	10.72	0.4219	70.0	118.0	45.0	12.00
R45411.0	—	11.00	0.4331	70.0	118.0	45.0	12.00
R4547/16	7/16	11.11	0.4375	70.0	118.0	45.0	12.00



Producto	DC	DC	DC	LCF	OAL	LS	DCON MS
	(inch)	(mm)	(inch)	(mm)	(mm)	(mm)	(mm)
R45411.2	–	11.20	0.4409	70.0	118.0	45.0	12.00
R45411.4	–	11.40	0.4488	70.0	118.0	45.0	12.00
R45411.5	–	11.50	0.4528	70.0	118.0	45.0	12.00
R45429/64	29/64	11.51	0.4531	70.0	118.0	45.0	12.00
R45411.6	–	11.60	0.4567	70.0	118.0	45.0	12.00
R45411.8	–	11.80	0.4646	70.0	118.0	45.0	12.00
R45415/32	15/32	11.91	0.4688	70.0	118.0	45.0	12.00
R45412.0	–	12.00	0.4724	70.0	118.0	45.0	12.00
R45412.1	–	12.10	0.4764	76.0	124.0	45.0	14.00
R45412.2	–	12.20	0.4803	76.0	124.0	45.0	14.00
R45431/64	31/64	12.30	0.4844	76.0	124.0	45.0	14.00
R45412.5	–	12.50	0.4921	76.0	124.0	45.0	14.00
R45412.7	–	12.70	0.5000	76.0	124.0	45.0	14.00
R4541/2	1/2	12.70	0.5000	76.0	124.0	45.0	14.00
R45412.8	–	12.80	0.5039	76.0	124.0	45.0	14.00
R45413.0	–	13.00	0.5118	76.0	124.0	45.0	14.00
R45433/64	33/64	13.10	0.5156	76.0	124.0	45.0	14.00
R45417/32	17/32	13.49	0.5313	76.0	124.0	45.0	14.00
R45413.5	–	13.50	0.5315	76.0	124.0	45.0	14.00
R45413.8	–	13.80	0.5433	76.0	124.0	45.0	14.00
R45435/64	35/64	13.89	0.5469	76.0	124.0	45.0	14.00
R45414.0	–	14.00	0.5512	76.0	124.0	45.0	14.00
R45414.25	–	14.25	0.5610	82.0	133.0	48.0	16.00
R4549/16	9/16	14.29	0.5625	82.0	133.0	48.0	16.00
R45414.5	–	14.50	0.5709	82.0	133.0	48.0	16.00
R45437/64	37/64	14.68	0.5781	82.0	133.0	48.0	16.00
R45414.8	–	14.80	0.5827	82.0	133.0	48.0	16.00
R45415.0	–	15.00	0.5906	82.0	133.0	48.0	16.00
R45419/32	19/32	15.08	0.5938	82.0	133.0	48.0	16.00
R45415.1	–	15.10	0.5945	82.0	133.0	48.0	16.00
R45439/64	39/64	15.48	0.6094	82.0	133.0	48.0	16.00
R45415.5	–	15.50	0.6102	82.0	133.0	48.0	16.00
R45415.8	–	15.80	0.6220	82.0	133.0	48.0	16.00
R4545/8	5/8	15.88	0.6250	82.0	133.0	48.0	16.00
R45416.0	–	16.00	0.6299	82.0	133.0	48.0	16.00
R45441/64	41/64	16.27	0.6406	91.0	143.0	48.0	18.00
R45416.5	–	16.50	0.6496	91.0	143.0	48.0	18.00
R45421/32	21/32	16.67	0.6563	91.0	143.0	48.0	18.00
R45417.0	–	17.00	0.6693	91.0	143.0	48.0	18.00
R45443/64	43/64	17.07	0.6720	91.0	143.0	48.0	18.00
R45411/16	11/16	17.46	0.6874	91.0	143.0	48.0	18.00
R45417.5	–	17.50	0.6890	91.0	143.0	48.0	18.00
R45417.8	–	17.80	0.7008	91.0	143.0	48.0	18.00
R45445/64	45/64	17.86	0.7031	91.0	143.0	48.0	18.00
R45418.0	–	18.00	0.7087	91.0	143.0	48.0	18.00
R45423/32	23/32	18.26	0.7189	99.0	153.0	50.0	20.00
R45418.5	–	18.50	0.7283	99.0	153.0	50.0	20.00
R45447/64	47/64	18.65	0.7343	99.0	153.0	50.0	20.00
R45419.0	–	19.00	0.7480	99.0	153.0	50.0	20.00
R4543/4	3/4	19.05	0.7500	99.0	153.0	50.0	20.00
R45419.5	–	19.50	0.7677	99.0	153.0	50.0	20.00
R45419.8	–	19.80	0.7795	99.0	153.0	50.0	20.00
R45420.0	–	20.00	0.7874	99.0	153.0	50.0	20.00



R453



Broca FORCE X, Metal Duro 5XD, con Refrigeración Interna, con Recubrimiento TiAlN

Broca de alto rendimiento, capaz de producir agujeros precisos y de alta calidad a altas velocidades y avances (tolerancia de agujero H9). Punta dividida de 4 facetas a 140° y alma continuamente adelgazada (CTW) para mejorar los índices de penetración. Los agujeros de refrigeración permiten mejorar la evacuación de virutas. El recubrimiento TiAlN aumenta la dureza superficial y prolonga la vida de la herramienta.

FORCE X

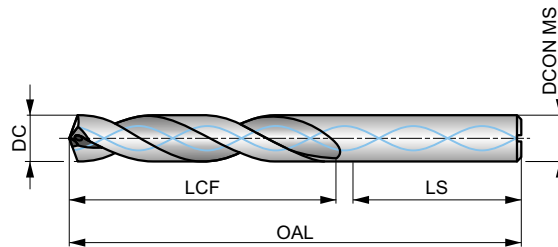

HM	DIN 6537L	5xD
140°	TiAlN	DIN 6535HA
CTW	DC m7	

Grupo de Material de la pieza adecuado y condiciones de velocidad de corte iniciales (m/min) y código de avance alfabético. Tablas con avance por revolución a partir de la pag. 65.

P1.1 ■ 170 V	P1.2 ■ 190 V	P1.3 ■ 197 V	P2.1 ■ 145 V	P2.2 ■ 128 V	P2.3 ■ 113 V	P3.1 ■ 126 V	P3.2 ■ 102 V	P3.3 ■ 86 V	P4.1 ■ 75 V	P4.2 ■ 64 V	P4.3 ■ 52 U	M1.1 ■ 71 V	M1.2 ■ 61 V
M2.1 ■ 64 V	M2.2 ■ 52 V	M2.3 ■ 44 U	M3.1 ■ 39 V	M3.2 ■ 33 V	M3.3 ■ 30 V	M4.1 ■ 29 U	M4.2 ■ 25 U	K1.1 ■ 105 W	K1.2 ■ 77 W	K1.3 ■ 58 W	K2.1 ■ 93 V	K2.2 ■ 76 V	K2.3 ■ 61 V
K3.1 ■ 83 V	K3.2 ■ 64 V	K3.3 ■ 51 V	K4.1 ■ 77 V	K4.2 ■ 58 V	K4.3 ■ 43 V	K4.4 ■ 36 V	K4.5 ■ 30 V	K5.1 ■ 86 V	K5.2 ■ 66 V	K5.3 ■ 50 V	N1.1 ■ 238 W	N1.2 ■ 179 W	N1.3 ■ 119 W
N2.1 ■ 293 V	N2.2 ■ 263 V	N2.3 ■ 190 V	N3.1 ■ 354 W	N3.2 ■ 209 W	N3.3 ■ 105 W	S1.1 ■ 52 V	S1.2 ■ 43 V	S1.3 ■ 38 U	H1.1 ■ 53 U	H2.1 ■ 31 U	H2.2 ■ 29 U	H3.1 ■ 35 U	H3.2 ■ 29 U

DCON MS tolerancia h6.

Producto	DC (inch)	DC (mm)	DC (inch)	LCF (mm)	OAL (mm)	LS (mm)	DCON MS (mm)
R4533.0	—	3.00	0.1181	28.0	66.0	36.0	6.00
R4533.1	—	3.10	0.1220	28.0	66.0	36.0	6.00
R4531/8	1/8	3.18	0.1250	28.0	66.0	36.0	6.00
R4533.2	—	3.20	0.1260	28.0	66.0	36.0	6.00
R453N30	N30	3.26	0.1283	28.0	66.0	36.0	6.00
R4533.3	—	3.30	0.1299	28.0	66.0	36.0	6.00
R4533.4	—	3.40	0.1339	28.0	66.0	36.0	6.00
R453N29	N29	3.45	0.1360	28.0	66.0	36.0	6.00
R4533.5	—	3.50	0.1378	28.0	66.0	36.0	6.00
R453N28	N28	3.57	0.1406	28.0	66.0	36.0	6.00
R4539/64	9/64	3.57	0.1406	28.0	66.0	36.0	6.00
R4533.6	—	3.60	0.1417	28.0	66.0	36.0	6.00
R453N27	N27	3.66	0.1441	28.0	66.0	36.0	6.00
R4533.7	—	3.70	0.1457	28.0	66.0	36.0	6.00
R453N26	N26	3.73	0.1469	36.0	74.0	36.0	6.00
R453N25	N25	3.80	0.1496	36.0	74.0	36.0	6.00
R4533.8	—	3.80	0.1496	36.0	74.0	36.0	6.00
R453N24	N24	3.86	0.1520	36.0	74.0	36.0	6.00
R4533.9	—	3.90	0.1535	36.0	74.0	36.0	6.00
R453N23	N23	3.91	0.1539	36.0	74.0	36.0	6.00
R4535/32	5/32	3.97	0.1563	36.0	74.0	36.0	6.00
R453N22	N22	3.99	0.1571	36.0	74.0	36.0	6.00
R4534.0	—	4.00	0.1575	36.0	74.0	36.0	6.00
R453N21	N21	4.04	0.1591	36.0	74.0	36.0	6.00
R4534.05	—	4.05	0.1594	36.0	74.0	36.0	6.00



Producto	DC	DC	DC	LCF	OAL	LS	DCON MS
	(inch)	(mm)	(inch)	(mm)	(mm)	(mm)	(mm)
R453N20	N20	4.09	0.1610	36.0	74.0	36.0	6.00
R4534.1	–	4.10	0.1614	36.0	74.0	36.0	6.00
R4534.2	–	4.20	0.1654	36.0	74.0	36.0	6.00
R453N19	N19	4.22	0.1661	36.0	74.0	36.0	6.00
R4534.3	–	4.30	0.1693	36.0	74.0	36.0	6.00
R453N18	N18	4.31	0.1697	36.0	74.0	36.0	6.00
R45311/64	11/64	4.37	0.1719	36.0	74.0	36.0	6.00
R453N17	N17	4.39	0.1728	36.0	74.0	36.0	6.00
R4534.4	–	4.40	0.1732	36.0	74.0	36.0	6.00
R4534.5	–	4.50	0.1772	36.0	74.0	36.0	6.00
R453N16	N16	4.50	0.1772	36.0	74.0	36.0	6.00
R453N15	N15	4.57	0.1799	36.0	74.0	36.0	6.00
R4534.6	–	4.60	0.1811	36.0	74.0	36.0	6.00
R453N14	N14	4.62	0.1819	36.0	74.0	36.0	6.00
R453N13	N13	4.70	0.1850	36.0	74.0	36.0	6.00
R4534.7	–	4.70	0.1850	36.0	74.0	36.0	6.00
R4533/16	3/16	4.76	0.1875	44.0	82.0	36.0	6.00
R4534.8	–	4.80	0.1890	44.0	82.0	36.0	6.00
R453N12	N12	4.80	0.1890	44.0	82.0	36.0	6.00
R453N11	N11	4.85	0.1909	44.0	82.0	36.0	6.00
R4534.9	–	4.90	0.1929	44.0	82.0	36.0	6.00
R453N10	N10	4.92	0.1937	44.0	82.0	36.0	6.00
R453N9	N9	4.98	0.1961	44.0	82.0	36.0	6.00
R4535.0	–	5.00	0.1969	44.0	82.0	36.0	6.00
R4535.05	–	5.05	0.1988	44.0	82.0	36.0	6.00
R453N8	N8	5.06	0.1992	44.0	82.0	36.0	6.00
R4535.1	–	5.10	0.2008	44.0	82.0	36.0	6.00
R453N7	N7	5.11	0.2010	44.0	82.0	36.0	6.00
R45313/64	13/64	5.16	0.2031	44.0	82.0	36.0	6.00
R453N6	N6	5.18	0.2039	44.0	82.0	36.0	6.00
R4535.2	–	5.20	0.2047	44.0	82.0	36.0	6.00
R453N5	N5	5.22	0.2055	44.0	82.0	36.0	6.00
R4535.3	–	5.30	0.2087	44.0	82.0	36.0	6.00
R453N4	N4	5.31	0.2091	44.0	82.0	36.0	6.00
R4535.4	–	5.40	0.2126	44.0	82.0	36.0	6.00
R453N3	N3	5.41	0.2130	44.0	82.0	36.0	6.00
R4535.5	–	5.50	0.2165	44.0	82.0	36.0	6.00
R4537/32	7/32	5.56	0.2188	44.0	82.0	36.0	6.00
R4535.6	–	5.60	0.2205	44.0	82.0	36.0	6.00
R453N2	N2	5.61	0.2209	44.0	82.0	36.0	6.00
R4535.7	–	5.70	0.2244	44.0	82.0	36.0	6.00
R453N1	N1	5.79	0.2280	44.0	82.0	36.0	6.00
R4535.8	–	5.80	0.2283	44.0	82.0	36.0	6.00
R4535.9	–	5.90	0.2323	44.0	82.0	36.0	6.00
R453A	A	5.94	0.2339	44.0	82.0	36.0	6.00
R45315/64	15/64	5.95	0.2344	44.0	82.0	36.0	6.00
R4536.0	–	6.00	0.2362	44.0	82.0	36.0	6.00
R453B	B	6.05	0.2380	53.0	91.0	36.0	8.00
R4536.05	–	6.05	0.2382	53.0	91.0	36.0	8.00
R4536.1	–	6.10	0.2402	53.0	91.0	36.0	8.00
R453C	C	6.15	0.2421	53.0	91.0	36.0	8.00
R4536.2	–	6.20	0.2441	53.0	91.0	36.0	8.00
R453D	D	6.25	0.2461	53.0	91.0	36.0	8.00
R4536.3	–	6.30	0.2480	53.0	91.0	36.0	8.00
R4531/4	1/4	6.35	0.2500	53.0	91.0	36.0	8.00
R453E	E	6.35	0.2500	53.0	91.0	36.0	8.00
R4536.4	–	6.40	0.2520	53.0	91.0	36.0	8.00
R4536.5	–	6.50	0.2559	53.0	91.0	36.0	8.00
R453F	F	6.53	0.2571	53.0	91.0	36.0	8.00
R4536.6	–	6.60	0.2598	53.0	91.0	36.0	8.00
R453G	G	6.63	0.2610	53.0	91.0	36.0	8.00
R4536.7	–	6.70	0.2638	53.0	91.0	36.0	8.00
R45317/64	17/64	6.75	0.2656	53.0	91.0	36.0	8.00
R453H	H	6.76	0.2661	53.0	91.0	36.0	8.00
R4536.8	–	6.80	0.2677	53.0	91.0	36.0	8.00



Producto	DC	DC	DC	LCF	OAL	LS	DCON MS
	(inch)	(mm)	(inch)	(mm)	(mm)	(mm)	(mm)
R4536.9	—	6.90	0.2717	53.0	91.0	36.0	8.00
R453I	I	6.91	0.2720	53.0	91.0	36.0	8.00
R4537.0	—	7.00	0.2756	53.0	91.0	36.0	8.00
R453J	J	7.04	0.2772	53.0	91.0	36.0	8.00
R4537.1	—	7.10	0.2795	53.0	91.0	36.0	8.00
R453K	K	7.14	0.2811	53.0	91.0	36.0	8.00
R4539/32	9/32	7.14	0.2813	53.0	91.0	36.0	8.00
R4537.2	—	7.20	0.2835	53.0	91.0	36.0	8.00
R4537.3	—	7.30	0.2874	53.0	91.0	36.0	8.00
R453L	L	7.37	0.2902	53.0	91.0	36.0	8.00
R4537.4	—	7.40	0.2913	53.0	91.0	36.0	8.00
R453M	M	7.49	0.2949	53.0	91.0	36.0	8.00
R4537.5	—	7.50	0.2953	53.0	91.0	36.0	8.00
R45319/64	19/64	7.54	0.2969	53.0	91.0	36.0	8.00
R4537.6	—	7.60	0.2992	53.0	91.0	36.0	8.00
R453N	N	7.67	0.3020	53.0	91.0	36.0	8.00
R4537.7	—	7.70	0.3031	53.0	91.0	36.0	8.00
R4537.8	—	7.80	0.3071	53.0	91.0	36.0	8.00
R4537.9	—	7.90	0.3110	53.0	91.0	36.0	8.00
R4535/16	5/16	7.94	0.3125	53.0	91.0	36.0	8.00
R4538.0	—	8.00	0.3150	53.0	91.0	36.0	8.00
R453O	O	8.03	0.3161	61.0	103.0	40.0	10.00
R4538.05	—	8.05	0.3169	61.0	103.0	40.0	10.00
R4538.1	—	8.10	0.3189	61.0	103.0	40.0	10.00
R4538.2	—	8.20	0.3228	61.0	103.0	40.0	10.00
R453P	P	8.20	0.3228	61.0	103.0	40.0	10.00
R4538.3	—	8.30	0.3268	61.0	103.0	40.0	10.00
R45321/64	21/64	8.33	0.3281	61.0	103.0	40.0	10.00
R4538.4	—	8.40	0.3307	61.0	103.0	40.0	10.00
R453Q	Q	8.43	0.3319	61.0	103.0	40.0	10.00
R4538.5	—	8.50	0.3346	61.0	103.0	40.0	10.00
R4538.6	—	8.60	0.3386	61.0	103.0	40.0	10.00
R453R	R	8.61	0.3390	61.0	103.0	40.0	10.00
R4538.7	—	8.70	0.3425	61.0	103.0	40.0	10.00
R45311/32	11/32	8.73	0.3438	61.0	103.0	40.0	10.00
R4538.8	—	8.80	0.3465	61.0	103.0	40.0	10.00
R453S	S	8.84	0.3480	61.0	103.0	40.0	10.00
R4538.9	—	8.90	0.3504	61.0	103.0	40.0	10.00
R4539.0	—	9.00	0.3543	61.0	103.0	40.0	10.00
R453T	T	9.09	0.3579	61.0	103.0	40.0	10.00
R4539.1	—	9.10	0.3583	61.0	103.0	40.0	10.00
R45323/64	23/64	9.13	0.3594	61.0	103.0	40.0	10.00
R4539.2	—	9.20	0.3622	61.0	103.0	40.0	10.00
R4539.3	—	9.30	0.3661	61.0	103.0	40.0	10.00
R453U	U	9.35	0.3681	61.0	103.0	40.0	10.00
R4539.4	—	9.40	0.3701	61.0	103.0	40.0	10.00
R4539.5	—	9.50	0.3740	61.0	103.0	40.0	10.00
R4533/8	3/8	9.53	0.3750	61.0	103.0	40.0	10.00
R453V	V	9.58	0.3772	61.0	103.0	40.0	10.00
R4539.6	—	9.60	0.3780	61.0	103.0	40.0	10.00
R4539.7	—	9.70	0.3819	61.0	103.0	40.0	10.00
R4539.8	—	9.80	0.3858	61.0	103.0	40.0	10.00
R453W	W	9.80	0.3858	61.0	103.0	40.0	10.00
R4539.9	—	9.90	0.3898	61.0	103.0	40.0	10.00
R45325/64	25/64	9.92	0.3906	61.0	103.0	40.0	10.00
R45310.0	—	10.00	0.3937	61.0	103.0	40.0	10.00
R45310.05	—	10.05	0.3957	70.0	118.0	45.0	12.00
R453X	X	10.08	0.3969	70.0	118.0	45.0	12.00
R45310.1	—	10.10	0.3976	70.0	118.0	45.0	12.00
R45310.2	—	10.20	0.4016	70.0	118.0	45.0	12.00
R453Y	Y	10.26	0.4039	70.0	118.0	45.0	12.00
R45310.3	—	10.30	0.4055	70.0	118.0	45.0	12.00
R45313/32	13/32	10.32	0.4063	70.0	118.0	45.0	12.00
R45310.4	—	10.40	0.4094	70.0	118.0	45.0	12.00
R453Z	Z	10.49	0.4130	70.0	118.0	45.0	12.00



Producto	DC	DC	DC	LCF	OAL	LS	DCON MS
	(inch)	(mm)	(inch)	(mm)	(mm)	(mm)	(mm)
R45310.5	–	10.50	0.4134	70.0	118.0	45.0	12.00
R45310.6	–	10.60	0.4173	70.0	118.0	45.0	12.00
R45327/64	27/64	10.72	0.4219	70.0	118.0	45.0	12.00
R45310.8	–	10.80	0.4252	70.0	118.0	45.0	12.00
R45311.0	–	11.00	0.4331	70.0	118.0	45.0	12.00
R4537/16	7/16	11.11	0.4375	70.0	118.0	45.0	12.00
R45311.2	–	11.20	0.4409	70.0	118.0	45.0	12.00
R45311.3	–	11.30	0.4449	70.0	118.0	45.0	12.00
R45311.4	–	11.40	0.4488	70.0	118.0	45.0	12.00
R45311.5	–	11.50	0.4528	70.0	118.0	45.0	12.00
R45329/64	29/64	11.51	0.4531	70.0	118.0	45.0	12.00
R45311.6	–	11.60	0.4567	70.0	118.0	45.0	12.00
R45311.8	–	11.80	0.4646	70.0	118.0	45.0	12.00
R45315/32	15/32	11.91	0.4688	70.0	118.0	45.0	12.00
R45312.0	–	12.00	0.4724	70.0	118.0	45.0	12.00
R45312.05	–	12.05	0.4744	76.0	124.0	45.0	14.00
R45312.2	–	12.20	0.4803	76.0	124.0	45.0	14.00
R45331/64	31/64	12.30	0.4844	76.0	124.0	45.0	14.00
R45312.5	–	12.50	0.4921	76.0	124.0	45.0	14.00
R45312.7	–	12.70	0.5000	76.0	124.0	45.0	14.00
R4531/2	1/2	12.70	0.5000	76.0	124.0	45.0	14.00
R45312.8	–	12.80	0.5039	76.0	124.0	45.0	14.00
R45313.0	–	13.00	0.5118	76.0	124.0	45.0	14.00
R45333/64	33/64	13.10	0.5156	76.0	124.0	45.0	14.00
R45313.3	–	13.30	0.5236	76.0	124.0	45.0	14.00
R45317/32	17/32	13.49	0.5313	76.0	124.0	45.0	14.00
R45313.5	–	13.50	0.5315	76.0	124.0	45.0	14.00
R45313.8	–	13.80	0.5433	76.0	124.0	45.0	14.00
R45335/64	35/64	13.89	0.5469	76.0	124.0	45.0	14.00
R45314.0	–	14.00	0.5512	76.0	124.0	45.0	14.00
R45314.25	–	14.25	0.5610	82.0	133.0	48.0	16.00
R4539/16	9/16	14.29	0.5625	82.0	133.0	48.0	16.00
R45314.5	–	14.50	0.5709	82.0	133.0	48.0	16.00
R45337/64	37/64	14.68	0.5781	82.0	133.0	48.0	16.00
R45314.8	–	14.80	0.5827	82.0	133.0	48.0	16.00
R45315.0	–	15.00	0.5906	82.0	133.0	48.0	16.00
R45319/32	19/32	15.08	0.5938	82.0	133.0	48.0	16.00
R45315.1	–	15.10	0.5945	82.0	133.0	48.0	16.00
R45315.3	–	15.30	0.6024	82.0	133.0	48.0	16.00
R45339/64	39/64	15.48	0.6094	82.0	133.0	48.0	16.00
R45315.5	–	15.50	0.6102	82.0	133.0	48.0	16.00
R45315.8	–	15.80	0.6220	82.0	133.0	48.0	16.00
R4535/8	5/8	15.88	0.6250	82.0	133.0	48.0	16.00
R45316.0	–	16.00	0.6299	82.0	133.0	48.0	16.00
R45341/64	41/64	16.27	0.6406	91.0	143.0	48.0	18.00
R45316.5	–	16.50	0.6496	91.0	143.0	48.0	18.00
R45321/32	21/32	16.67	0.6563	91.0	143.0	48.0	18.00
R45317.0	–	17.00	0.6693	91.0	143.0	48.0	18.00
R45343/64	43/64	17.07	0.6720	91.0	143.0	48.0	18.00
R45311/16	11/16	17.46	0.6874	91.0	143.0	48.0	18.00
R45317.5	–	17.50	0.6890	91.0	143.0	48.0	18.00
R45317.8	–	17.80	0.7008	91.0	143.0	48.0	18.00
R45345/64	45/64	17.86	0.7031	91.0	143.0	48.0	18.00
R45318.0	–	18.00	0.7087	91.0	143.0	48.0	18.00
R45323/32	23/32	18.26	0.7189	99.0	143.0	48.0	20.00
R45318.5	–	18.50	0.7283	99.0	153.0	50.0	20.00
R45347/64	47/64	18.65	0.7343	99.0	153.0	50.0	20.00
R45319.0	–	19.00	0.7480	99.0	153.0	50.0	20.00
R4533/4	3/4	19.05	0.7500	99.0	153.0	50.0	20.00
R45319.5	–	19.50	0.7677	99.0	153.0	50.0	20.00
R45319.8	–	19.80	0.7795	99.0	153.0	50.0	20.00
R45320.0	–	20.00	0.7874	99.0	153.0	50.0	20.00



R459



Broca FORCE X, Metal Duro 8XD, con Refrigeración Interna, con Recubrimiento TiAlN

Broca de alto rendimiento, capaz de producir agujeros precisos y de alta calidad a altas velocidades y avances (tolerancia de agujero H9). Punta dividida de 4 facetas a 140° y alma continuamente adelgazada (CTW) para mejorar los índices de penetración. Los agujeros de refrigeración permiten mejorar la evacuación de virutas. El recubrimiento TiAlN aumenta la dureza superficial y prolonga la vida de la herramienta.

FORCE X

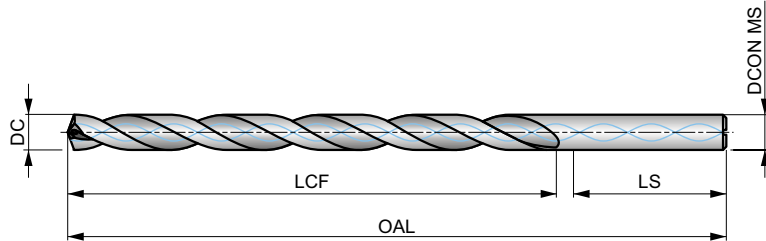

HM	DORMER	8xD
140°	TiAlN	DIN 6535HA
CTW	DC m7	

Grupo de Material de la pieza adecuado y condiciones de velocidad de corte iniciales (m/min) y código de avance alfabético. Tablas con avance por revolución a partir de la pag. 65.

P1.1 ■ 143 V	P1.2 ■ 160 V	P1.3 ■ 166 V	P2.1 ■ 122 V	P2.2 ■ 108 U	P2.3 ■ 95 U	P3.1 ■ 106 U	P3.2 ■ 86 U	P3.3 ■ 72 U	P4.1 ■ 63 U	P4.2 ■ 54 U	P4.3 ■ 44 T	M1.1 ■ 60 V	M1.2 ■ 51 V
M2.1 ■ 154 V	M2.2 ■ 44 V	M2.3 ■ 37 U	M3.1 ■ 33 V	M3.2 ■ 28 V	M3.3 ■ 26 V	M4.1 ■ 24 U	M4.2 ■ 21 U	K1.1 ■ 88 W	K1.2 ■ 65 W	K1.3 ■ 49 W	K2.1 ■ 78 V	K2.2 ■ 64 V	K2.3 ■ 51 V
K3.1 ■ 70 V	K3.2 ■ 54 V	K3.3 ■ 43 V	K4.1 ■ 65 V	K4.2 ■ 49 V	K4.3 ■ 36 V	K4.4 ■ 30 V	K4.5 ■ 26 V	K5.1 ■ 73 V	K5.2 ■ 55 V	K5.3 ■ 42 V	N1.1 ■ 200 W	N1.2 ■ 150 W	N1.3 ■ 100 W
N2.1 ■ 246 V	N2.2 ■ 222 V	N2.3 ■ 160 V	N3.1 ■ 298 V	N3.2 ■ 176 V	N3.3 ■ 188 V								

DCON MS tolerancia h6.

Producto	DC (inch)	DC (mm)	DC (inch)	LCF (mm)	OAL (mm)	LS (mm)	DCON MS (mm)
R4593.0	—	3.00	0.1181	37.0	79.0	36.0	6.00
R4593.1	—	3.10	0.1220	37.0	79.0	36.0	6.00
R4591/8	1/8	3.18	0.1250	37.0	79.0	36.0	6.00
R4593.2	—	3.20	0.1260	37.0	79.0	36.0	6.00
R4593.3	—	3.30	0.1299	37.0	79.0	36.0	6.00
R4593.4	—	3.40	0.1339	37.0	79.0	36.0	6.00
R4593.5	—	3.50	0.1378	37.0	79.0	36.0	6.00
R4599/64	9/64	3.57	0.1406	37.0	79.0	36.0	6.00
R4593.6	—	3.60	0.1417	37.0	79.0	36.0	6.00
R4593.7	—	3.70	0.1457	37.0	79.0	36.0	6.00
R4593.8	—	3.80	0.1496	48.0	90.0	36.0	6.00
R4593.9	—	3.90	0.1535	48.0	90.0	36.0	6.00
R4595/32	5/32	3.97	0.1563	48.0	90.0	36.0	6.00
R4594.0	—	4.00	0.1575	48.0	90.0	36.0	6.00
R4594.1	—	4.10	0.1614	48.0	90.0	36.0	6.00
R4594.2	—	4.20	0.1654	48.0	90.0	36.0	6.00
R4594.3	—	4.30	0.1693	48.0	90.0	36.0	6.00
R45911/64	11/64	4.37	0.1719	48.0	90.0	36.0	6.00
R4594.4	—	4.40	0.1732	48.0	90.0	36.0	6.00
R4594.5	—	4.50	0.1772	48.0	90.0	36.0	6.00
R4594.6	—	4.60	0.1811	48.0	90.0	36.0	6.00
R4594.7	—	4.70	0.1850	62.0	104.0	36.0	6.00
R4593/16	3/16	4.76	0.1875	62.0	104.0	36.0	6.00
R4594.8	—	4.80	0.1890	62.0	104.0	36.0	6.00
R4594.9	—	4.90	0.1929	62.0	104.0	36.0	6.00



Producto	DC	DC	DC	LCF	OAL	LS	DCON MS
	(inch)	(mm)	(inch)	(mm)	(mm)	(mm)	(mm)
R4595.0	–	5.00	0.1969	62.0	104.0	36.0	6.00
R4595.1	–	5.10	0.2008	62.0	104.0	36.0	6.00
R45913/64	13/64	5.16	0.2031	62.0	104.0	36.0	6.00
R4595.2	–	5.20	0.2047	62.0	104.0	36.0	6.00
R4595.3	–	5.30	0.2087	62.0	104.0	36.0	6.00
R4595.4	–	5.40	0.2126	62.0	104.0	36.0	6.00
R4595.5	–	5.50	0.2165	62.0	104.0	36.0	6.00
R4597/32	7/32	5.56	0.2188	62.0	104.0	36.0	6.00
R4595.6	–	5.60	0.2205	62.0	104.0	36.0	6.00
R4595.7	–	5.70	0.2244	62.0	104.0	36.0	6.00
R4595.8	–	5.80	0.2283	62.0	104.0	36.0	6.00
R4595.9	–	5.90	0.2323	62.0	104.0	36.0	6.00
R45915/64	15/64	5.95	0.2344	62.0	104.0	36.0	6.00
R4596.0	–	6.00	0.2362	62.0	104.0	36.0	6.00
R4596.1	–	6.10	0.2402	84.0	126.0	36.0	8.00
R4596.2	–	6.20	0.2441	84.0	126.0	36.0	8.00
R4596.3	–	6.30	0.2480	84.0	126.0	36.0	8.00
R4591/4	1/4	6.35	0.2500	84.0	126.0	36.0	8.00
R4596.4	–	6.40	0.2520	84.0	126.0	36.0	8.00
R4596.5	–	6.50	0.2559	84.0	126.0	36.0	8.00
R4596.6	–	6.60	0.2598	84.0	126.0	36.0	8.00
R4596.7	–	6.70	0.2638	84.0	126.0	36.0	8.00
R45917/64	17/64	6.75	0.2656	84.0	126.0	36.0	8.00
R4596.8	–	6.80	0.2677	84.0	126.0	36.0	8.00
R4596.9	–	6.90	0.2717	84.0	126.0	36.0	8.00
R4597.0	–	7.00	0.2756	84.0	126.0	36.0	8.00
R4597.1	–	7.10	0.2795	84.0	126.0	36.0	8.00
R4599/32	9/32	7.14	0.2813	84.0	126.0	36.0	8.00
R4597.2	–	7.20	0.2835	84.0	126.0	36.0	8.00
R4597.3	–	7.30	0.2874	84.0	126.0	36.0	8.00
R4597.4	–	7.40	0.2913	84.0	126.0	36.0	8.00
R4597.5	–	7.50	0.2953	84.0	126.0	36.0	8.00
R45919/64	19/64	7.54	0.2969	84.0	126.0	36.0	8.00
R4597.6	–	7.60	0.2992	84.0	126.0	36.0	8.00
R4597.7	–	7.70	0.3031	84.0	126.0	36.0	8.00
R4597.8	–	7.80	0.3071	84.0	126.0	36.0	8.00
R4597.9	–	7.90	0.3110	84.0	126.0	36.0	8.00
R4595/16	5/16	7.94	0.3125	84.0	126.0	36.0	8.00
R4598.0	–	8.00	0.3150	84.0	126.0	36.0	8.00
R4598.1	–	8.10	0.3189	106.0	152.0	40.0	10.00
R4598.2	–	8.20	0.3228	106.0	152.0	40.0	10.00
R4598.3	–	8.30	0.3268	106.0	152.0	40.0	10.00
R45921/64	21/64	8.33	0.3281	106.0	152.0	40.0	10.00
R4598.4	–	8.40	0.3307	106.0	152.0	40.0	10.00
R4598.5	–	8.50	0.3346	106.0	152.0	40.0	10.00
R4598.6	–	8.60	0.3386	106.0	152.0	40.0	10.00
R4598.7	–	8.70	0.3425	106.0	152.0	40.0	10.00
R45911/32	11/32	8.73	0.3438	106.0	152.0	40.0	10.00
R4598.8	–	8.80	0.3465	106.0	152.0	40.0	10.00
R4598.9	–	8.90	0.3504	106.0	152.0	40.0	10.00
R4599.0	–	9.00	0.3543	106.0	152.0	40.0	10.00
R4599.1	–	9.10	0.3583	106.0	152.0	40.0	10.00
R45923/64	23/64	9.13	0.3594	106.0	152.0	40.0	10.00
R4599.2	–	9.20	0.3622	106.0	152.0	40.0	10.00
R4599.3	–	9.30	0.3661	106.0	152.0	40.0	10.00
R4599.4	–	9.40	0.3701	106.0	152.0	40.0	10.00
R4599.5	–	9.50	0.3740	106.0	152.0	40.0	10.00
R4593/8	3/8	9.53	0.3750	106.0	152.0	40.0	10.00
R4599.6	–	9.60	0.3780	106.0	152.0	40.0	10.00
R4599.7	–	9.70	0.3819	106.0	152.0	40.0	10.00
R4599.8	–	9.80	0.3858	106.0	152.0	40.0	10.00
R4599.9	–	9.90	0.3898	106.0	152.0	40.0	10.00



Producto	DC	DC	DC	LCF	OAL	LS	DCON MS
	(inch)	(mm)	(inch)	(mm)	(mm)	(mm)	(mm)
R45925/64	25/64	9.92	0.3906	106.0	152.0	40.0	10.00
R45910.0	–	10.00	0.3937	106.0	152.0	40.0	10.00
R45910.2	–	10.20	0.4016	128.0	180.0	45.0	12.00
R45910.3	–	10.30	0.4055	128.0	180.0	45.0	12.00
R45913/32	13/32	10.32	0.4063	128.0	180.0	45.0	12.00
R45910.4	–	10.40	0.4094	128.0	180.0	45.0	12.00
R45910.5	–	10.50	0.4134	128.0	180.0	45.0	12.00
R45927/64	27/64	10.72	0.4219	128.0	180.0	45.0	12.00
R45910.8	–	10.80	0.4252	128.0	180.0	45.0	12.00
R45911.0	–	11.00	0.4331	128.0	180.0	45.0	12.00
R4597/16	7/16	11.11	0.4375	128.0	180.0	45.0	12.00
R45911.2	–	11.20	0.4409	128.0	180.0	45.0	12.00
R45911.3	–	11.30	0.4449	128.0	180.0	45.0	12.00
R45911.5	–	11.50	0.4528	128.0	180.0	45.0	12.00
R45929/64	29/64	11.51	0.4531	128.0	180.0	45.0	12.00
R45911.8	–	11.80	0.4646	128.0	180.0	45.0	12.00
R45915/32	15/32	11.91	0.4688	128.0	180.0	45.0	12.00
R45912.0	–	12.00	0.4724	128.0	180.0	45.0	12.00
R45912.2	–	12.20	0.4803	151.0	202.0	48.0	14.00
R45931/64	31/64	12.30	0.4844	151.0	202.0	48.0	14.00
R45912.5	–	12.50	0.4921	151.0	202.0	48.0	14.00
R4591/2	1/2	12.70	0.5000	151.0	202.0	48.0	14.00
R45912.8	–	12.80	0.5039	151.0	202.0	48.0	14.00
R45913.0	–	13.00	0.5118	151.0	202.0	48.0	14.00
R45933/64	33/64	13.10	0.5156	151.0	202.0	48.0	14.00
R45917/32	17/32	13.49	0.5313	151.0	202.0	48.0	14.00
R45913.5	–	13.50	0.5315	151.0	202.0	48.0	14.00
R45935/64	35/64	13.89	0.5469	151.0	202.0	48.0	14.00
R45914.0	–	14.00	0.5512	151.0	202.0	48.0	14.00
R45914.25	–	14.25	0.5610	172.0	227.0	48.0	16.00
R4599/16	9/16	14.29	0.5625	172.0	227.0	48.0	16.00
R45914.5	–	14.50	0.5709	172.0	227.0	48.0	16.00
R45937/64	37/64	14.68	0.5781	172.0	227.0	48.0	16.00
R45915.0	–	15.00	0.5906	172.0	227.0	48.0	16.00
R45919/32	19/32	15.08	0.5938	172.0	227.0	48.0	16.00
R45915.1	–	15.10	0.5945	172.0	227.0	48.0	16.00
R45939/64	39/64	15.48	0.6094	172.0	227.0	48.0	16.00
R45915.5	–	15.50	0.6102	172.0	227.0	48.0	16.00
R4595/8	5/8	15.88	0.6250	172.0	227.0	48.0	16.00
R45916.0	–	16.00	0.6299	172.0	227.0	48.0	16.00



R467

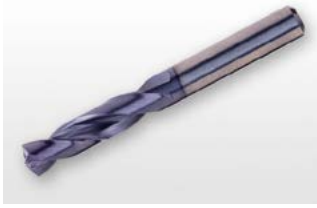

Broca FORCE M, Metal Duro 3XD, con Refrigeración Interna, con Recubrimiento TiAlN

Broca de alto rendimiento, capaz de producir agujeros precisos y de alta calidad a altas velocidades y avances (tolerancia de agujero H9 en acero inoxidable y materiales termoresistentes). Punta dividida de 4 facetas a 140° y alma continuamente adelgazada (CTW). Los agujeros de refrigeración permiten mejorar la evacuación de virutas. El recubrimiento TiN aumenta la dureza superficial y prolonga la vida de la herramienta.

FORCE M

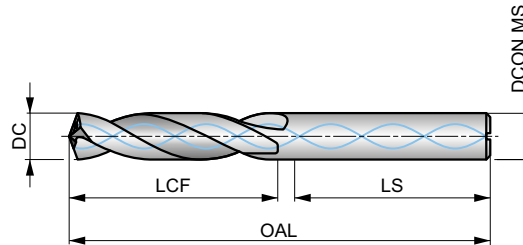

HM	DIN 6537K	3xD
140°	TiAlN	DIN 6535HA
GTW	DC m7	

Grupo de Material de la pieza adecuado y condiciones de velocidad de corte iniciales (m/min) y código de avance alfabético. Tablas con avance por revolución a partir de la pag. 65.

M1.1 ■ 117 G	M1.2 ■ 99 G	M2.1 ■ 104 G	M2.2 ■ 85 G	M2.3 ■ 71 E	M3.1 ■ 87 G	M3.2 ■ 75 G	M3.3 ■ 68 F	M4.1 ■ 60 F	M4.2 ■ 52 E	S1.1 ■ 55 V	S1.2 ■ 45 V	S1.3 ■ 40 U	S2.1 ■ 60 U
S2.2 ■ 56 U	S3.1 ■ 45 U	S3.2 ■ 40 U	S4.1 ■ 35 U	S4.2 ■ 32 U									

DCON MS tolerancia h6.

Producto	DC (inch)	DC (mm)	DC (inch)	LCF (mm)	OAL (mm)	LS (mm)	DCON MS (mm)
R4673.0	–	3.00	0.1181	20.0	62.0	36.0	6.00
R4673.1	–	3.10	0.1220	20.0	62.0	36.0	6.00
R4671/8	1/8	3.18	0.1250	20.0	62.0	36.0	6.00
R4673.2	–	3.20	0.1260	20.0	62.0	36.0	6.00
R4673.3	–	3.30	0.1299	20.0	62.0	36.0	6.00
R4673.4	–	3.40	0.1339	20.0	62.0	36.0	6.00
R467N29	N29	3.45	0.1360	20.0	62.0	36.0	6.00
R4673.5	–	3.50	0.1378	20.0	62.0	36.0	6.00
R4679/64	9/64	3.57	0.1406	20.0	62.0	36.0	6.00
R4673.6	–	3.60	0.1417	20.0	62.0	36.0	6.00
R4673.7	–	3.70	0.1457	20.0	62.0	36.0	6.00
R4673.8	–	3.80	0.1496	24.0	66.0	36.0	6.00
R4673.9	–	3.90	0.1535	24.0	66.0	36.0	6.00
R4675/32	5/32	3.97	0.1563	24.0	66.0	36.0	6.00
R4674.0	–	4.00	0.1575	24.0	66.0	36.0	6.00
R4674.05	–	4.05	0.1594	24.0	66.0	36.0	6.00
R4674.1	–	4.10	0.1614	24.0	66.0	36.0	6.00
R4674.2	–	4.20	0.1654	24.0	66.0	36.0	6.00
R4674.3	–	4.30	0.1693	24.0	66.0	36.0	6.00
R46711/64	11/64	4.37	0.1719	24.0	66.0	36.0	6.00
R4674.4	–	4.40	0.1732	24.0	66.0	36.0	6.00
R4674.5	–	4.50	0.1772	24.0	66.0	36.0	6.00
R4674.6	–	4.60	0.1811	24.0	66.0	36.0	6.00
R4674.7	–	4.70	0.1850	24.0	66.0	36.0	6.00
R4673/16	3/16	4.76	0.1875	28.0	66.0	36.0	6.00
R4674.8	–	4.80	0.1890	28.0	66.0	36.0	6.00
R4674.9	–	4.90	0.1929	28.0	66.0	36.0	6.00
R4675.0	–	5.00	0.1969	28.0	66.0	36.0	6.00
R4675.05	–	5.05	0.1988	28.0	66.0	36.0	6.00



Producto	DC	DC	DC	LCF	OAL	LS	DCON MS
	(inch)	(mm)	(inch)	(mm)	(mm)	(mm)	(mm)
R4675.1	—	5.10	0.2008	28.0	66.0	36.0	6.00
R467N7	N7	5.11	0.2010	28.0	66.0	36.0	6.00
R46713/64	13/64	5.16	0.2031	28.0	66.0	36.0	6.00
R4675.2	—	5.20	0.2047	28.0	66.0	36.0	6.00
R467N5	N5	5.22	0.2055	28.0	66.0	36.0	6.00
R4675.3	—	5.30	0.2087	28.0	66.0	36.0	6.00
R4675.4	—	5.40	0.2126	28.0	66.0	36.0	6.00
R4675.5	—	5.50	0.2165	28.0	66.0	36.0	6.00
R4677/32	7/32	5.56	0.2188	28.0	66.0	36.0	6.00
R4675.6	—	5.60	0.2205	28.0	66.0	36.0	6.00
R4675.7	—	5.70	0.2244	28.0	66.0	36.0	6.00
R4675.8	—	5.80	0.2283	28.0	66.0	36.0	6.00
R4675.9	—	5.90	0.2323	28.0	66.0	36.0	6.00
R46715/64	15/64	5.95	0.2344	28.0	66.0	36.0	6.00
R4676.0	—	6.00	0.2362	28.0	66.0	36.0	6.00
R4676.05	—	6.05	0.2382	34.0	79.0	36.0	8.00
R4676.1	—	6.10	0.2402	34.0	79.0	36.0	8.00
R4676.2	—	6.20	0.2441	34.0	79.0	36.0	8.00
R4676.3	—	6.30	0.2480	34.0	79.0	36.0	8.00
R4671/4	1/4	6.35	0.2500	34.0	79.0	36.0	8.00
R4676.4	—	6.40	0.2520	34.0	79.0	36.0	8.00
R4676.5	—	6.50	0.2559	34.0	79.0	36.0	8.00
R4676.6	—	6.60	0.2598	34.0	79.0	36.0	8.00
R4676.7	—	6.70	0.2638	34.0	79.0	36.0	8.00
R46717/64	17/64	6.75	0.2656	34.0	79.0	36.0	8.00
R4676.8	—	6.80	0.2677	34.0	79.0	36.0	8.00
R4676.9	—	6.90	0.2717	34.0	79.0	36.0	8.00
R4677.0	—	7.00	0.2756	34.0	79.0	36.0	8.00
R4677.1	—	7.10	0.2795	41.0	79.0	36.0	8.00
R4679/32	9/32	7.14	0.2813	41.0	79.0	36.0	8.00
R4677.2	—	7.20	0.2835	41.0	79.0	36.0	8.00
R4677.3	—	7.30	0.2874	41.0	79.0	36.0	8.00
R4677.4	—	7.40	0.2913	41.0	79.0	36.0	8.00
R4677.5	—	7.50	0.2953	41.0	79.0	36.0	8.00
R46719/64	19/64	7.54	0.2969	41.0	79.0	36.0	8.00
R4677.6	—	7.60	0.2992	41.0	79.0	36.0	8.00
R4677.7	—	7.70	0.3031	41.0	79.0	36.0	8.00
R4677.8	—	7.80	0.3071	41.0	79.0	36.0	8.00
R4677.9	—	7.90	0.3110	41.0	79.0	36.0	8.00
R4675/16	5/16	7.94	0.3125	41.0	79.0	36.0	8.00
R4678.0	—	8.00	0.3150	41.0	79.0	36.0	8.00
R4678.05	—	8.05	0.3169	47.0	89.0	40.0	10.00
R4678.1	—	8.10	0.3189	47.0	89.0	40.0	10.00
R4678.2	—	8.20	0.3228	47.0	89.0	40.0	10.00
R4678.3	—	8.30	0.3268	47.0	89.0	40.0	10.00
R46721/64	21/64	8.33	0.3281	47.0	89.0	40.0	10.00
R4678.4	—	8.40	0.3307	47.0	89.0	40.0	10.00
R4678.5	—	8.50	0.3346	47.0	89.0	40.0	10.00
R4678.6	—	8.60	0.3386	47.0	89.0	40.0	10.00
R4678.7	—	8.70	0.3425	47.0	89.0	40.0	10.00
R46711/32	11/32	8.73	0.3438	47.0	89.0	40.0	10.00
R4678.8	—	8.80	0.3465	47.0	89.0	40.0	10.00
R4678.9	—	8.90	0.3504	47.0	89.0	40.0	10.00
R4679.0	—	9.00	0.3543	47.0	89.0	40.0	10.00
R4679.1	—	9.10	0.3583	47.0	89.0	40.0	10.00
R46723/64	23/64	9.13	0.3594	47.0	89.0	40.0	10.00
R4679.2	—	9.20	0.3622	47.0	89.0	40.0	10.00
R4679.3	—	9.30	0.3661	47.0	89.0	40.0	10.00
R4679.4	—	9.40	0.3701	47.0	89.0	40.0	10.00
R4679.5	—	9.50	0.3740	47.0	89.0	40.0	10.00
R4673/8	3/8	9.53	0.3750	47.0	89.0	40.0	10.00
R4679.6	—	9.60	0.3780	47.0	89.0	40.0	10.00



Producto	DC	DC	DC	LCF	OAL	LS	DCON MS
	(inch)	(mm)	(inch)	(mm)	(mm)	(mm)	(mm)
R4679.7	–	9.70	0.3819	47.0	89.0	40.0	10.00
R4679.8	–	9.80	0.3858	47.0	89.0	40.0	10.00
R4679.9	–	9.90	0.3898	47.0	89.0	40.0	10.00
R46725/64	25/64	9.92	0.3906	47.0	89.0	40.0	10.00
R46710.0	–	10.00	0.3937	47.0	89.0	40.0	10.00
R46710.05	–	10.05	0.3957	55.0	102.0	45.0	12.00
R46710.1	–	10.10	0.3976	55.0	102.0	45.0	12.00
R46710.2	–	10.20	0.4016	55.0	102.0	45.0	12.00
R46710.3	–	10.30	0.4055	55.0	102.0	45.0	12.00
R46713/32	13/32	10.32	0.4063	55.0	102.0	45.0	12.00
R46710.4	–	10.40	0.4094	55.0	102.0	45.0	12.00
R46710.5	–	10.50	0.4134	55.0	102.0	45.0	12.00
R46710.6	–	10.60	0.4173	55.0	102.0	45.0	12.00
R46727/64	27/64	10.72	0.4219	55.0	102.0	45.0	12.00
R46710.8	–	10.80	0.4252	55.0	102.0	45.0	12.00
R46710.9	–	10.90	0.4291	55.0	102.0	45.0	12.00
R46711.0	–	11.00	0.4331	55.0	102.0	45.0	12.00
R4677/16	7/16	11.11	0.4375	55.0	102.0	45.0	12.00
R46711.2	–	11.20	0.4409	55.0	102.0	45.0	12.00
R46711.3	–	11.30	0.4449	55.0	102.0	45.0	12.00
R46711.4	–	11.40	0.4488	55.0	102.0	45.0	12.00
R46711.5	–	11.50	0.4528	55.0	102.0	45.0	12.00
R46729/64	29/64	11.51	0.4531	55.0	102.0	45.0	12.00
R46711.6	–	11.60	0.4567	55.0	102.0	45.0	12.00
R46711.8	–	11.80	0.4646	55.0	102.0	45.0	12.00
R46715/32	15/32	11.91	0.4688	55.0	102.0	45.0	12.00
R46712.0	–	12.00	0.4724	55.0	102.0	45.0	12.00
R46712.05	–	12.05	0.4744	60.0	107.0	45.0	14.00
R46712.1	–	12.10	0.4764	60.0	107.0	45.0	14.00
R46712.2	–	12.20	0.4803	60.0	107.0	45.0	14.00
R46731/64	31/64	12.30	0.4844	60.0	107.0	45.0	14.00
R46712.5	–	12.50	0.4921	60.0	107.0	45.0	14.00
R46712.7	–	12.70	0.5000	60.0	107.0	45.0	14.00
R4671/2	1/2	12.70	0.5000	60.0	107.0	45.0	14.00
R46712.8	–	12.80	0.5039	60.0	107.0	45.0	14.00
R46713.0	–	13.00	0.5118	60.0	107.0	45.0	14.00
R46733/64	33/64	13.10	0.5156	60.0	107.0	45.0	14.00
R46713.3	–	13.30	0.5236	60.0	107.0	45.0	14.00
R46717/32	17/32	13.49	0.5313	60.0	107.0	45.0	14.00
R46713.5	–	13.50	0.5315	60.0	107.0	45.0	14.00
R46713.8	–	13.80	0.5433	60.0	107.0	45.0	14.00
R46735/64	35/64	13.89	0.5469	60.0	107.0	45.0	14.00
R46714.0	–	14.00	0.5512	60.0	107.0	45.0	14.00
R46714.25	–	14.25	0.5610	65.0	115.0	48.0	16.00
R4679/16	9/16	14.29	0.5625	65.0	115.0	48.0	16.00
R46714.5	–	14.50	0.5709	65.0	115.0	48.0	16.00
R46737/64	37/64	14.68	0.5781	65.0	115.0	48.0	16.00
R46714.8	–	14.80	0.5827	65.0	115.0	48.0	16.00
R46715.0	–	15.00	0.5906	65.0	115.0	48.0	16.00
R46719/32	19/32	15.08	0.5938	65.0	115.0	48.0	16.00
R46715.1	–	15.10	0.5945	65.0	115.0	48.0	16.00
R46715.3	–	15.30	0.6024	65.0	115.0	48.0	16.00
R46739/64	39/64	15.48	0.6094	65.0	115.0	48.0	16.00
R46715.5	–	15.50	0.6102	65.0	115.0	48.0	16.00
R46715.8	–	15.80	0.6220	65.0	115.0	48.0	16.00
R4675/8	5/8	15.88	0.6250	65.0	115.0	48.0	16.00
R46716.0	–	16.00	0.6299	65.0	115.0	48.0	16.00



R463



Broca FORCE M, Metal Duro 5XD, con Refrigeración Interna, con Recubrimiento TiAlN

Broca de alto rendimiento, capaz de producir agujeros precisos y de alta calidad a altas velocidades y avances (tolerancia de agujero H9 en acero inoxidable y materiales termoresistentes). Punta dividida de 4 facetas a 140° y alma continuamente adelgazada (CTW). Los agujeros de refrigeración permiten mejorar la evacuación de virutas. El recubrimiento TiN aumenta la dureza superficial y prolonga la vida de la herramienta.

FORCE M

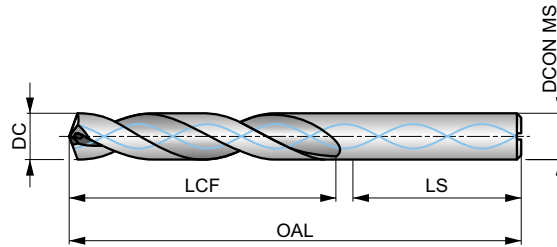

HM	DIN 6537L	5xD
140°	TiAlN	DIN 6535HA
CTW	DC m7	

Grupo de Material de la pieza adecuado y condiciones de velocidad de corte iniciales (m/min) y código de avance alfabético. Tablas con avance por revolución a partir de la pag. 65.

M1.1 ■ 111 G	M1.2 ■ 94 G	M2.1 ■ 99 G	M2.2 ■ 81 G	M2.3 ■ 67 E	M3.1 ■ 83 G	M3.2 ■ 71 G	M3.3 ■ 65 F	M4.1 ■ 57 F	M4.2 ■ 49 E	S1.1 ■ 52 V	S1.2 ■ 43 V	S1.3 ■ 38 U	S2.1 ■ 57 U
S2.2 ■ 53 U	S3.1 ■ 43 U	S3.2 ■ 38 U	S4.1 ■ 33 U	S4.2 ■ 30 U									

DCON MS tolerancia h6.

Producto	DC (inch)	DC (mm)	DC (inch)	LCF (mm)	OAL (mm)	LS (mm)	DCON MS (mm)
R4633.0	—	3.00	0.1181	28.0	66.0	36.0	6.00
R4633.1	—	3.10	0.1220	28.0	66.0	36.0	6.00
R4631/8	1/8	3.18	0.1250	28.0	66.0	36.0	6.00
R4633.2	—	3.20	0.1260	28.0	66.0	36.0	6.00
R4633.3	—	3.30	0.1299	28.0	66.0	36.0	6.00
R4633.4	—	3.40	0.1339	28.0	66.0	36.0	6.00
R463N29	N29	3.45	0.1360	28.0	66.0	36.0	6.00
R4633.5	—	3.50	0.1378	28.0	66.0	36.0	6.00
R4639/64	9/64	3.57	0.1406	28.0	66.0	36.0	6.00
R4633.6	—	3.60	0.1417	28.0	66.0	36.0	6.00
R4633.7	—	3.70	0.1457	28.0	66.0	36.0	6.00
R4633.8	—	3.80	0.1496	36.0	74.0	36.0	6.00
R4633.9	—	3.90	0.1535	36.0	74.0	36.0	6.00
R4635/32	5/32	3.97	0.1563	36.0	74.0	36.0	6.00
R4634.0	—	4.00	0.1575	36.0	74.0	36.0	6.00
R4634.05	—	4.05	0.1594	36.0	74.0	36.0	6.00
R4634.1	—	4.10	0.1614	36.0	74.0	36.0	6.00
R4634.2	—	4.20	0.1654	36.0	74.0	36.0	6.00
R4634.3	—	4.30	0.1693	36.0	74.0	36.0	6.00
R46311/64	11/64	4.37	0.1719	36.0	74.0	36.0	6.00
R4634.4	—	4.40	0.1732	36.0	74.0	36.0	6.00
R4634.5	—	4.50	0.1772	36.0	74.0	36.0	6.00
R4634.6	—	4.60	0.1811	36.0	74.0	36.0	6.00
R4634.7	—	4.70	0.1850	36.0	74.0	36.0	6.00
R4633/16	3/16	4.76	0.1875	44.0	82.0	36.0	6.00
R4634.8	—	4.80	0.1890	44.0	82.0	36.0	6.00
R4634.9	—	4.90	0.1929	44.0	82.0	36.0	6.00
R4635.0	—	5.00	0.1969	44.0	82.0	36.0	6.00
R4635.05	—	5.05	0.1988	44.0	82.0	36.0	6.00



Producto	DC	DC	DC	LCF	OAL	LS	DCON MS
	(inch)	(mm)	(inch)	(mm)	(mm)	(mm)	(mm)
R4635.1	–	5.10	0.2008	44.0	82.0	36.0	6.00
R463N7	N7	5.11	0.2010	44.0	82.0	36.0	6.00
R46313/64	13/64	5.16	0.2031	44.0	82.0	36.0	6.00
R4635.2	–	5.20	0.2047	44.0	82.0	36.0	6.00
R463N5	N5	5.22	0.2055	44.0	82.0	36.0	6.00
R4635.3	–	5.30	0.2087	44.0	82.0	36.0	6.00
R4635.4	–	5.40	0.2126	44.0	82.0	36.0	6.00
R4635.5	–	5.50	0.2165	44.0	82.0	36.0	6.00
R4637/32	7/32	5.56	0.2188	44.0	82.0	36.0	6.00
R4635.6	–	5.60	0.2205	44.0	82.0	36.0	6.00
R4635.7	–	5.70	0.2244	44.0	82.0	36.0	6.00
R4635.8	–	5.80	0.2283	44.0	82.0	36.0	6.00
R4635.9	–	5.90	0.2323	44.0	82.0	36.0	6.00
R46315/64	15/64	5.95	0.2344	44.0	82.0	36.0	6.00
R4636.0	–	6.00	0.2362	44.0	82.0	36.0	6.00
R4636.05	–	6.05	0.2382	53.0	91.0	36.0	8.00
R4636.1	–	6.10	0.2402	53.0	91.0	36.0	8.00
R4636.2	–	6.20	0.2441	53.0	91.0	36.0	8.00
R4636.3	–	6.30	0.2480	53.0	91.0	36.0	8.00
R4631/4	1/4	6.35	0.2500	53.0	91.0	36.0	8.00
R4636.4	–	6.40	0.2520	53.0	91.0	36.0	8.00
R4636.5	–	6.50	0.2559	53.0	91.0	36.0	8.00
R4636.6	–	6.60	0.2598	53.0	91.0	36.0	8.00
R4636.7	–	6.70	0.2638	53.0	91.0	36.0	8.00
R46317/64	17/64	6.75	0.2656	53.0	91.0	36.0	8.00
R4636.8	–	6.80	0.2677	53.0	91.0	36.0	8.00
R4636.9	–	6.90	0.2717	53.0	91.0	36.0	8.00
R4637.0	–	7.00	0.2756	53.0	91.0	36.0	8.00
R4637.1	–	7.10	0.2795	53.0	91.0	36.0	8.00
R4639/32	9/32	7.14	0.2813	53.0	91.0	36.0	8.00
R4637.2	–	7.20	0.2835	53.0	91.0	36.0	8.00
R4637.3	–	7.30	0.2874	53.0	91.0	36.0	8.00
R4637.4	–	7.40	0.2913	53.0	91.0	36.0	8.00
R4637.5	–	7.50	0.2953	53.0	91.0	36.0	8.00
R46319/64	19/64	7.54	0.2969	53.0	91.0	36.0	8.00
R4637.6	–	7.60	0.2992	53.0	91.0	36.0	8.00
R4637.7	–	7.70	0.3031	53.0	91.0	36.0	8.00
R4637.8	–	7.80	0.3071	53.0	91.0	36.0	8.00
R4637.9	–	7.90	0.3110	53.0	91.0	36.0	8.00
R4635/16	5/16	7.94	0.3125	53.0	91.0	36.0	8.00
R4638.0	–	8.00	0.3150	53.0	91.0	36.0	8.00
R4638.05	–	8.05	0.3169	61.0	103.0	40.0	10.00
R4638.1	–	8.10	0.3189	61.0	103.0	40.0	10.00
R4638.2	–	8.20	0.3228	61.0	103.0	40.0	10.00
R4638.3	–	8.30	0.3268	61.0	103.0	40.0	10.00
R46321/64	21/64	8.33	0.3281	61.0	103.0	40.0	10.00
R4638.4	–	8.40	0.3307	61.0	103.0	40.0	10.00
R4638.5	–	8.50	0.3346	61.0	103.0	40.0	10.00
R4638.6	–	8.60	0.3386	61.0	103.0	40.0	10.00
R4638.7	–	8.70	0.3425	61.0	103.0	40.0	10.00
R46311/32	11/32	8.73	0.3438	61.0	103.0	40.0	10.00
R4638.8	–	8.80	0.3465	61.0	103.0	40.0	10.00
R4638.9	–	8.90	0.3504	61.0	103.0	40.0	10.00
R4639.0	–	9.00	0.3543	61.0	103.0	40.0	10.00
R4639.1	–	9.10	0.3583	61.0	103.0	40.0	10.00
R46323/64	23/64	9.13	0.3594	61.0	103.0	40.0	10.00
R4639.2	–	9.20	0.3622	61.0	103.0	40.0	10.00
R4639.3	–	9.30	0.3661	61.0	103.0	40.0	10.00
R4639.4	–	9.40	0.3701	61.0	103.0	40.0	10.00
R4639.5	–	9.50	0.3740	61.0	103.0	40.0	10.00
R4633/8	3/8	9.53	0.3750	61.0	103.0	40.0	10.00
R4639.6	–	9.60	0.3780	61.0	103.0	40.0	10.00



Producto	DC	DC	DC	LCF	OAL	LS	DCON MS
	(inch)	(mm)	(inch)	(mm)	(mm)	(mm)	(mm)
R4639.7	–	9.70	0.3819	61.0	103.0	40.0	10.00
R4639.8	–	9.80	0.3858	61.0	103.0	40.0	10.00
R4639.9	–	9.90	0.3898	61.0	103.0	40.0	10.00
R46325/64	25/64	9.92	0.3906	61.0	103.0	40.0	10.00
R46310.0	–	10.00	0.3937	61.0	103.0	40.0	10.00
R46310.05	–	10.05	0.3957	70.0	118.0	45.0	12.00
R46310.1	–	10.10	0.3976	70.0	118.0	45.0	12.00
R46310.2	–	10.20	0.4016	70.0	118.0	45.0	12.00
R46310.3	–	10.30	0.4055	70.0	118.0	45.0	12.00
R46313/32	13/32	10.32	0.4063	70.0	118.0	45.0	12.00
R46310.4	–	10.40	0.4094	70.0	118.0	45.0	12.00
R46310.5	–	10.50	0.4134	70.0	118.0	45.0	12.00
R46310.6	–	10.60	0.4173	70.0	118.0	45.0	12.00
R46327/64	27/64	10.72	0.4219	70.0	118.0	45.0	12.00
R46310.8	–	10.80	0.4252	70.0	118.0	45.0	12.00
R46310.9	–	10.90	0.4291	70.0	118.0	45.0	12.00
R46311.0	–	11.00	0.4331	70.0	118.0	45.0	12.00
R4637/16	7/16	11.11	0.4375	70.0	118.0	45.0	12.00
R46311.2	–	11.20	0.4409	70.0	118.0	45.0	12.00
R46311.3	–	11.30	0.4449	70.0	118.0	45.0	12.00
R46311.4	–	11.40	0.4488	70.0	118.0	45.0	12.00
R46311.5	–	11.50	0.4528	70.0	118.0	45.0	12.00
R46329/64	29/64	11.51	0.4531	70.0	118.0	45.0	12.00
R46311.6	–	11.60	0.4567	70.0	118.0	45.0	12.00
R46311.8	–	11.80	0.4646	70.0	118.0	45.0	12.00
R46315/32	15/32	11.91	0.4688	70.0	118.0	45.0	12.00
R46312.0	–	12.00	0.4724	70.0	118.0	45.0	12.00
R46312.05	–	12.05	0.4744	76.0	124.0	45.0	14.00
R46312.2	–	12.20	0.4803	76.0	124.0	45.0	14.00
R46331/64	31/64	12.30	0.4844	76.0	124.0	45.0	14.00
R46312.5	–	12.50	0.4921	76.0	124.0	45.0	14.00
R46312.7	–	12.70	0.5000	76.0	124.0	45.0	14.00
R4631/2	1/2	12.70	0.5000	76.0	124.0	45.0	14.00
R46312.8	–	12.80	0.5039	76.0	124.0	45.0	14.00
R46313.0	–	13.00	0.5118	76.0	124.0	45.0	14.00
R46333/64	33/64	13.10	0.5156	76.0	124.0	45.0	14.00
R46313.3	–	13.30	0.5236	76.0	124.0	45.0	14.00
R46317/32	17/32	13.49	0.5313	76.0	124.0	45.0	14.00
R46313.5	–	13.50	0.5315	76.0	124.0	45.0	14.00
R46313.8	–	13.80	0.5433	76.0	124.0	45.0	14.00
R46335/64	35/64	13.89	0.5469	76.0	124.0	45.0	14.00
R46314.0	–	14.00	0.5512	76.0	124.0	45.0	14.00
R46314.25	–	14.25	0.5610	82.0	133.0	48.0	16.00
R4639/16	9/16	14.29	0.5625	82.0	133.0	48.0	16.00
R46314.5	–	14.50	0.5709	82.0	133.0	48.0	16.00
R46337/64	37/64	14.68	0.5781	82.0	133.0	48.0	16.00
R46314.8	–	14.80	0.5827	82.0	133.0	48.0	16.00
R46315.0	–	15.00	0.5906	82.0	133.0	48.0	16.00
R46319/32	19/32	15.08	0.5938	82.0	133.0	48.0	16.00
R46315.1	–	15.10	0.5945	82.0	133.0	48.0	16.00
R46315.3	–	15.30	0.6024	82.0	133.0	48.0	16.00
R46339/64	39/64	15.48	0.6094	82.0	133.0	48.0	16.00
R46315.5	–	15.50	0.6102	82.0	133.0	48.0	16.00
R46315.8	–	15.80	0.6220	82.0	133.0	48.0	16.00
R4635/8	5/8	15.88	0.6250	82.0	133.0	48.0	16.00
R46316.0	–	16.00	0.6299	82.0	133.0	48.0	16.00



TABLA DE VELOCIDADES DE AVANCE DE TALADRADO

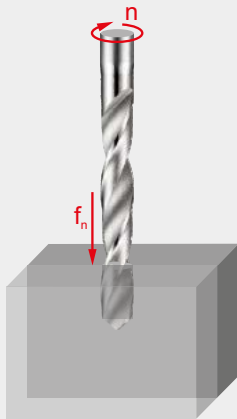

Avance por revolución (f_n en mm/rev)
Dependiendo de las condiciones de trabajo puede ser necesario ajustar estos valores $\pm 25\%$

Cómo utilizar esta tabla para encontrar el valor de avance por revolución (f_n):

1. Localice su código alfa en la página del producto (ejemplo: 46J, «J» es el código alfa).
2. Localice en la fila superior de la tabla el diámetro más adecuado para su aplicación de corte.
3. Localice su código alfa en la columna de la izquierda de la tabla.
4. La intersección (celda) del diámetro y el código alfa es el avance por revolución (f_n).

		ø DC (mm)																		
		0.15	0.50	1.00	2.00	3.00	4.00	5.00	6.00	8.00	10.00	12.00	15.00	16.00	20.00	25.00	30.00	40.00	50.00	100.00
Avances	A	0.003	0.006	0.012	0.023	0.029	0.032	0.036	0.042	0.054	0.062	0.069	0.082	0.086	0.110	0.125	0.135	0.155	0.175	0.263
	B	0.004	0.007	0.014	0.028	0.037	0.041	0.046	0.053	0.067	0.080	0.090	0.103	0.108	0.135	0.153	0.165	0.188	0.208	0.312
	C	0.004	0.008	0.015	0.032	0.044	0.050	0.056	0.064	0.080	0.098	0.110	0.125	0.130	0.160	0.180	0.195	0.220	0.240	0.360
	D	0.004	0.008	0.016	0.038	0.053	0.060	0.068	0.078	0.098	0.119	0.130	0.149	0.155	0.188	0.210	0.228	0.253	0.275	0.413
	E	0.004	0.009	0.017	0.043	0.062	0.071	0.080	0.092	0.115	0.140	0.150	0.173	0.180	0.215	0.240	0.260	0.285	0.310	0.465
	F	0.005	0.009	0.018	0.050	0.073	0.084	0.095	0.109	0.138	0.165	0.178	0.202	0.210	0.248	0.275	0.295	0.320	0.343	0.515
	G	0.005	0.010	0.019	0.056	0.084	0.096	0.109	0.126	0.160	0.190	0.205	0.231	0.240	0.280	0.310	0.330	0.355	0.375	0.563
	H	0.005	0.010	0.020	0.066	0.102	0.116	0.130	0.150	0.190	0.228	0.243	0.271	0.280	0.320	0.355	0.375	0.398	0.418	0.627
	I	0.005	0.011	0.021	0.076	0.119	0.134	0.150	0.173	0.220	0.265	0.280	0.310	0.320	0.360	0.400	0.420	0.440	0.460	0.690
	J	0.006	0.012	0.024	0.084	0.135	0.152	0.170	0.197	0.250	0.298	0.315	0.349	0.360	0.405	0.445	0.465	0.485	0.503	0.755
	K	0.007	0.013	0.026	0.092	0.150	0.170	0.190	0.220	0.280	0.330	0.350	0.388	0.400	0.450	0.490	0.510	0.530	0.545	0.818
	L	0.007	0.014	0.028	0.101	0.165	0.186	0.208	0.240	0.305	0.360	0.385	0.419	0.430	0.485	0.525	0.545	0.568	0.588	0.882
	M	0.008	0.015	0.030	0.110	0.180	0.202	0.225	0.260	0.330	0.390	0.420	0.450	0.460	0.520	0.560	0.580	0.605	0.630	0.945
	N	0.008	0.016	0.032	0.119	0.195	0.218	0.242	0.280	0.355	0.420	0.455	0.481	0.490	0.555	0.595	0.615	0.642	0.672	1.008
	S	0.002	0.004	0.008	0.014	0.020	0.025	0.030	0.037	0.050	0.080	0.100	0.123	0.130	0.150	0.170	0.190	0.220	0.240	–
	T	0.004	0.008	0.015	0.028	0.040	0.050	0.060	0.070	0.090	0.110	0.130	0.160	0.170	0.190	0.210	0.230	0.260	0.275	–
	U	0.007	0.013	0.026	0.048	0.070	0.080	0.090	0.107	0.140	0.170	0.200	0.223	0.230	0.240	0.270	0.300	0.360	0.375	–
	V	0.010	0.019	0.038	0.069	0.100	0.115	0.130	0.153	0.200	0.250	0.280	0.310	0.320	0.340	0.400	0.440	0.510	0.530	–
	W	0.012	0.025	0.049	0.089	0.130	0.150	0.170	0.200	0.260	0.330	0.380	0.418	0.430	0.450	0.470	0.490	0.520	0.540	–
	X	0.014	0.028	0.056	0.103	0.150	0.180	0.210	0.250	0.330	0.420	0.480	0.533	0.550	0.580	–	–	–	–	–
Y	0.017	0.034	0.068	0.124	0.180	0.220	0.260	0.317	0.430	0.550	0.700	0.700	0.700	0.740	–	–	–	–	–	
Z	0.024	0.047	0.094	0.172	0.250	0.325	0.400	0.533	0.800	1.000	1.100	1.175	1.200	1.200	–	–	–	–	–	





BROCAS DE HSS



BROCAS DE HSS: NAVEGADOR DE MATERIALES DE HERRAMIENTA





Materiales de herramientas

Acero rápido		Se trata de un acero rápido de aleación media que presenta una buena maquinabilidad y un excelente rendimiento. El HSS presenta características de dureza, tenacidad y resistencia al desgaste que lo hacen atractivo en una amplia variedad de aplicaciones, por ejemplo en brocas y machos de roscar.
Acero rápido al cobalto		Este acero rápido contiene cobalto para aumentar la dureza en caliente. La composición del HSCo proporciona una buena combinación de tenacidad y dureza. Posee una buena maquinabilidad y una elevada resistencia al desgaste, lo que lo hace apropiado para brocas, machos de roscar, fresas y escariadores.





Materiales de metal duro

Metal duro y High Speed Steel		Los materiales mixtos de metal duro y acero rápido suelen unirse con una aleación de soldadura fuerte a alta temperatura que actúa a modo de interfaz. Esta combinación soldada de materiales de herramientas ofrece una sección de corte de metal duro que proporciona una alta resistencia a la compresión, dureza y resistencia al desgaste, unida a un cuerpo de acero rápido que confiere resistencia a la flexión y tenacidad en el cuerpo de la herramienta.
--------------------------------------	-----------------------------------------------------------------------------------	---------------------------------------------------------------------------------------------------------------------------------------------------------------------------------------------------------------------------------------------------------------------------------------------------------------------------------------------------------------------------------------------------------------------------------------------------------------------

Tratamientos superficiales

Brillante (sin recubrimiento)		El acabado brillante (superficie sin recubrimiento) mejora el flujo de virutas en materiales suaves o materiales no féreos, plásticos y materiales compuestos, a la vez que mantiene afilados los filos de corte.
Combinación de brillante y templado al vapor		La combinación del recubrimiento brillante y el tratamiento de templado al vapor puede ser eficaz, ya que la superficie de óxido azul — más porosa— actúa para retener y guiar el fluido de corte hacia el interior del agujero, mientras que la superficie brillante ayuda a la evacuación de la viruta. Esta combinación se consigue rectificando la superficie brillante después del proceso de templado.
Tratamiento de templado al vapor		El templado al vapor proporciona una superficie de óxido azul fuertemente adherida que permite retener el fluido de corte y evitar que la viruta se sude con la herramienta, lo cual contrarresta la formación de un filo de aportación. El templado al vapor puede aplicarse a cualquier herramienta brillante, pero es más eficaz en brocas y machos de roscar.
Templado de bronce		El templado de bronce crea una fina y suave capa de óxido de bronce en la superficie de la herramienta. Al igual que el templado al vapor, ayuda a evitar la soldadura de la viruta con la herramienta y favorece la evacuación de la viruta. El templado de bronce puede aplicarse a cualquier herramienta brillante y también puede combinarse con el templado al vapor en algunas herramientas.

Recubrimientos superficiales

Brillante y TiN (recubrimiento de la punta)		El nitruro de titanio es un recubrimiento cerámico de color dorado que se aplica por deposición física de vapor (PVD). La alta dureza, combinada con las propiedades de baja fricción, garantizan una vida útil más larga de la herramienta y/o un mejor rendimiento de corte de las herramientas que no están recubiertas.
Nitruro de titanio (TiN)		El nitruro de titanio es un recubrimiento cerámico de color dorado que se aplica por deposición física de vapor (PVD). La alta dureza, combinada con las propiedades de baja fricción, garantizan una vida útil más larga de la herramienta y/o un mejor rendimiento de corte de las herramientas que no están recubiertas.
Recubrimientos de nitruro de aluminio y titanio (TiAlN, TiAlN-Top y X-CEED)	 	El nitruro de aluminio y titanio es un recubrimiento cerámico multicapa aplicado mediante la tecnología de recubrimiento PVD, que presenta una gran tenacidad y estabilidad a la oxidación. Estas propiedades lo convierten en ideal para alcanzar velocidades y avances más rápidos, al tiempo que mejora la vida útil de la herramienta. El TiAlN se utiliza en aplicaciones de taladrado, roscado con macho y fresado y es apropiado para el mecanizado sin refrigerante. El recubrimiento TiAlN-Top es el mismo que el TiAlN, pero con un proceso posterior al recubrimiento diseñado para suavizar las imperfecciones, mejorar el flujo de la viruta y reducir la formación de filos de aportación.
Recubrimientos Alcrona (Alcrona-Top)		La familia Alcrona (AlCrN) engloba recubrimientos de nitruro de aluminio y cromo que se utilizan principalmente para fresas. Las dos propiedades únicas de estos recubrimientos son la alta dureza en caliente y la alta resistencia a la oxidación. Cuando se utilizan en herramientas para aplicaciones de mecanizado que implican fuertes tensiones mecánicas y térmicas, estas propiedades se traducen en una mayor resistencia al desgaste. Existen varios niveles o versiones especiales de estos recubrimientos, que son específicos para diversas herramientas y aplicaciones.



Código de Material (BMC)	HSS-E	HSS	HSS	HSS	HSS	HSS	HSS-E	HSS-E	HSS	HSS HM	HSS-E	HSS-E	HSS-E
Grupo básico estándar (BSG)		DIN 1897	DIN 1897	DIN 1897	DIN 1897	DIN ANSI	DIN 1897	DIN 1897	DIN 1897	DIN 8037	DIN 1899	DIN ANSI	DIN ANSI
Longitud Útil (ULDR)	1xD	1.25xD	1xD	1.5xD	2.5xD	2.5xD	2.5xD	2.5xD	2.5xD	2.5xD	2.5xD	3xD	3xD
Ángulo de aplicación	180°	120°	90°/120°	120°	135°	135°	130°	135°	130°	118°	118°	130°	130°
Recubrimiento	Bronze	ST	Bright	ST	ST	TiN-Tip	Bronze	Bronze	TiN	Bright ST	Bright	Bright	Alcrona Top
Mango													
Forma de la Hélice	λ20-35°	λ20-35°	λ20-35°	λ20-35°	λ20-35°	λ20-35°	λ20-35°	λ20-35°	λ32-40°	λ10-20°	λ20-35°	λ>35°	λ>35°
Mano (dirección de corte)													
Refrigeración (CSP)													
									ADX			PFX	PFX
Código de Familia de Producto	A723	A119	A122	A123	A120	A022	A620	A117	A520	A124	A720	A920	A921
	6.00 - 8.00	3.30 - 5.10	6.00 - 20.00	3/32 - 1/4	0.50 - 25.00	0.50 - 16.00	2.50 - 13.00	1.00 - 13.00	3.00 - 13.00	3.00 - 16.00	0.15 - 1.40	1.00 - 20.00	2.50 - 16.00
P	P1	■	■	■	■	■	■	■	■	■	■	■	■
	P2	■	■	■	■	■	■	■	■	■	■	■	■
	P3	■	■	■	■	■	■	■	■	■	■	■	■
	P4	■	■	■	■	■	■	■	■	■	■	■	■
M	M1		■	■	■	■	■	■	■	■	■	■	■
	M2		■	■	■	■	■	■	■	■	■	■	■
	M3		■	■	■	■	■	■	■	■	■	■	■
	M4		■	■	■	■	■	■	■	■	■	■	■
K	K1			■	■	■	■	■	■	■	■	■	■
	K2			■	■	■	■	■	■	■	■	■	■
	K3			■	■	■	■	■	■	■	■	■	■
	K4			■	■	■	■	■	■	■	■	■	■
	K5			■	■	■	■	■	■	■	■	■	■
N	N1		■	■	■	■	■	■	■	■	■	■	■
	N2		■	■	■	■	■	■	■	■	■	■	■
	N3		■	■	■	■	■	■	■	■	■	■	■
	N4		■	■	■	■	■	■	■	■	■	■	■
	N5												
S	S1		■	■	■	■	■	■	■	■	■	■	■
	S2		■	■	■	■	■	■	■	■	■	■	■
	S3		■	■	■	■	■	■	■	■	■	■	■
	S4		■	■	■	■	■	■	■	■	■	■	■
H	H1												
	H2												
	H3												
	H4												

■ Primera Opción ■ Opción Alternativa



HSS	HSS	HSS	HSS	HSS	HSS-E	HSS-E	HSS HM	HSS	HSS-E	HSS-E	HSS-E	HSS	HSS	HSS
DIN 338	DIN 338	DIN 338	DIN 338	DIN 338	DIN 338	DIN 338	DIN 338	DIN 338	DIN 338	DIN 338	DIN ANSI	DIN ANSI	DIN ANSI	DIN ANSI
4xD	4xD	4xD	4xD	4xD	4xD	4xD	4xD	4xD	4xD	5xD	6xD	6xD	4xD	4xD
118°	118°	118°	118°	135°	130°	135°	118°	130°	130°	130°	130°	130°	118°	135°
TiN-Tip	TiN-Tip	ST	ST	ST	Bright	Bronze	Bright ST	TiN	TiAlN Top	Bright	Alcrona Top	ST	Bright	Bright
λ>20-35°	λ>20-35°	λ>20-35°	λ>20-35°	λ>35°	VA	λ>20-35°	λ>20-35°	λ>32-40°	λ>35°	λ>35°	λ>35°	λ>20-35°	λ>20-35°	λ>20-35°
R	R	R	L	R	R	R	R	R	R	R	R	R	R	R

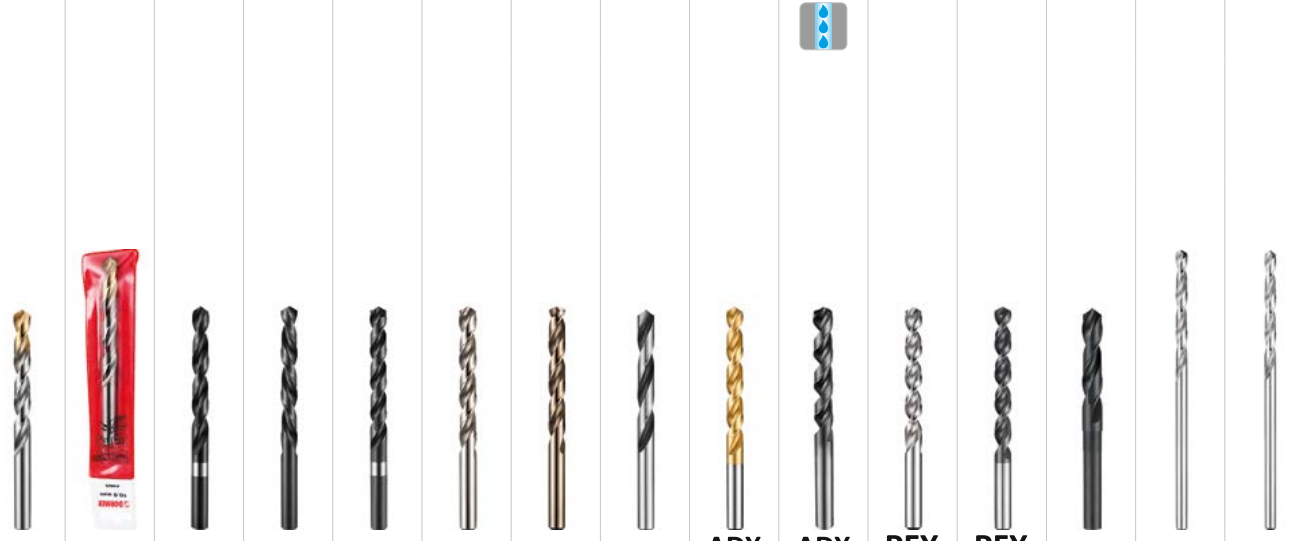

ADX ADX PFX PFX

A002	A002S	A100	A101	A108	A147	A777	A160	A510	A553	A900	A901	A170	A243	A244
1.00 - 16.00	2.00 - 13.00	0.20 - 20.00	1.00 - 12.00	1.00 - 16.00	0.30 - 15.0	0.30 - 16.00	4.00 - 16.00	3.00 - 14.00	5.00 - 20.00	1.00 - 20.00	1.50 - 16.00	13.00 - 1.1/2	3/32 - 1/4	1/8 - 1/4
96	98	99	103	104	106	108	110	111	113	114	116	118	120	121

P1	■	■	■	■	■	■	■	■	■	■	■	■	■	■
P2	■	■	■	■	■	■	■	■	■	■	■	■	■	■
P3	■	■	■	■	■	■	■	■	■	■	■	■	■	■
P4	■	■	■	■	■	■	■	■	■	■	■	■	■	■
M1	■	■	■	■	■	■	■	■	■	■	■	■	■	■
M2	■	■	■	■	■	■	■	■	■	■	■	■	■	■
M3	■	■	■	■	■	■	■	■	■	■	■	■	■	■
M4	■	■	■	■	■	■	■	■	■	■	■	■	■	■
K1	■	■	■	■	■	■	■	■	■	■	■	■	■	■
K2	■	■	■	■	■	■	■	■	■	■	■	■	■	■
K3	■	■	■	■	■	■	■	■	■	■	■	■	■	■
K4	■	■	■	■	■	■	■	■	■	■	■	■	■	■
K5	■	■	■	■	■	■	■	■	■	■	■	■	■	■
N1	■	■	■	■	■	■	■	■	■	■	■	■	■	■
N2	■	■	■	■	■	■	■	■	■	■	■	■	■	■
N3	■	■	■	■	■	■	■	■	■	■	■	■	■	■
N4	■	■	■	■	■	■	■	■	■	■	■	■	■	■
N5	■	■	■	■	■	■	■	■	■	■	■	■	■	■
S1	■	■	■	■	■	■	■	■	■	■	■	■	■	■
S2	■	■	■	■	■	■	■	■	■	■	■	■	■	■
S3	■	■	■	■	■	■	■	■	■	■	■	■	■	■
S4	■	■	■	■	■	■	■	■	■	■	■	■	■	■
H1														
H2														
H3														
H4														

■ Primera Opción □ Opción Alternativa



Código de Material (BMC)	HSS	HSS-E	HSS-E	HSS	HSS-E	HSS-E	HSS-E	HSS	HSS	HSS-E	HSS HM	HSS	HSS
Grupo básico estándar (BSG)	DIN 340	DIN ANSI	DIN ANSI	BS 328	DIN 1869-1	DIN 1869-2	DIN 1869-3	DIN 345	DIN 345	DIN 345	DIN 345	DIN 341	DIN 1870(1)
Longitud Útil (ULDR)	6×D	10×D	10×D	10×D	15×D	20×D	25×D	4×D	4×D	4×D	4×D	6×D	10×D
Ángulo de aplicación	118°	130°	130°	118°	130°	130°	130°	118°	118°	118°	118°	118°	118°
Recubrimiento	ST	Bright	Alcrona Top	ST	Bright	Bright	Bright	ST	TiN	Bronze	Bright ST	ST	ST
Mango													
Forma de la Hélice	λ>20-35°	λ>35°	λ>35°	λ>20-35°	λ>35°	λ>35°	λ>35°	λ>20-35°	λ>20-35°	λ>20-35°	λ>20-35°	λ>20-35°	λ>20-35°
Mano (dirección de corte)	R	R	R	R	R	R	R	R	R	R	R	R	R
Refrigeración (CSP)													
Código de Familia de Producto	A110	A940	A941	A125	A976	A977	A978	A130	A530	A730	A166	A350	A345
	0.50 - 1"	1.00 - 20.00	1.00 - 16.00	1.40 - 1"	1.50 - 14.00	1.50 - 14.00	3.00 - 10.00	3.00 - 50.80	8.50 - 40.00	10.00 - 32.00	10.00 - 33.00	5.00 - 50.00	8.00 - 50.00
	122	124	126	128	130	132	133	134	140	141	143	144	146
P	P1	■	■	■	■	■	■	■	■	■	■	■	■
	P2	■	■	■	■	■	■	■	■	■	■	■	■
	P3	■	■	■	■	■	■	■	■	■	■	■	■
	P4	■	■	■	■	■	■	■	■	■	■	■	■
M	M1	■	■	■	■	■	■	■	■	■	■	■	■
	M2	■	■	■	■	■	■	■	■	■	■	■	■
	M3	■	■	■	■	■	■	■	■	■	■	■	■
	M4	■	■	■	■	■	■	■	■	■	■	■	■
K	K1	■	■	■	■	■	■	■	■	■	■	■	■
	K2	■	■	■	■	■	■	■	■	■	■	■	■
	K3	■	■	■	■	■	■	■	■	■	■	■	■
	K4	■	■	■	■	■	■	■	■	■	■	■	■
	K5	■	■	■	■	■	■	■	■	■	■	■	■
N	N1	■	■	■	■	■	■	■	■	■	■	■	■
	N2	■	■	■	■	■	■	■	■	■	■	■	■
	N3	■	■	■	■	■	■	■	■	■	■	■	■
	N4	■	■	■	■	■	■	■	■	■	■	■	■
	N5	■	■	■	■	■	■	■	■	■	■	■	■
S	S1	■	■	■	■	■	■	■	■	■	■	■	■
	S2	■	■	■	■	■	■	■	■	■	■	■	■
	S3	■	■	■	■	■	■	■	■	■	■	■	■
	S4	■	■	■	■	■	■	■	■	■	■	■	■
H	H1												
	H2												
	H3												
	H4												

■ Primera Opción ■ Opción Alternativa



	HSS	HSS	HSS	HSS	HSS	HSS	HSS	HSS	HSS	HSS-E	HSS-E	HSS	HSS	HSS	HSS-E
	DIN 1870(1)	DIN 1870(2)	DIN 8374	DIN 8376	DIN 8377	DORNER	DORNER	DIN 333A	DIN 333A	DIN 333A	DIN 333A	DIN 333R	DORNER	BS 328	DIN 333A
	15xD	20xD	4xD	4xD	4xD	2.5xD	2.5xD	1xD	1xD	1xD	1xD	1xD	1xD	1xD	1xD
	130°	130°	90°	180°	180°	90°	180°	60°	60°	60°	60°	R	60°	60°	60°
	Bright ST	Bright ST	ST	ST	ST	ST	ST	Bright	TN	Bright	TAIN	Bright	Bright	Bright	Bright
	$\lambda > 35^\circ$	$\lambda > 35^\circ$	$\lambda > 20-35^\circ$	$\lambda > 20-35^\circ$	$\lambda > 20-35^\circ$										
	R	R	R	R	R	R	R	R	R	R	R	R	R	R	R
	A951	A952	A400	A402	A405	A412	A413	A200	A205	A206	A266	A210	A201	A225	A237
	10.00 - 30.00	8.00 - 40.00	M3 - M10	M3 - M10	M6 - M18	M3 - M10	M3 - M10	0.50 - 12.50	1.00 - 5.00	1.00 - 5.00	1.00 - 5.00	0.50 - 10.00	0.63 - 6.00	3/64 - 5/16	1.60 - 10.00
	148	149	150	151	152	153	154	155	156	157	158	159	160	161	162
P1	■	■	■	■	■	■	■	■	■	■	■	■	■	■	■
P2	■	■	■	■	■	■	■	■	■	■	■	■	■	■	■
P3	■	■	■	■	■	■	■	■	■	■	■	■	■	■	■
P4	■	■	■	■	■	■	■	■	■	■	■	■	■	■	■
M1	■	■	■	■	■	■	■	■	■	■	■	■	■	■	■
M2	■	■	■	■	■	■	■	■	■	■	■	■	■	■	■
M3	■	■	■	■	■	■	■	■	■	■	■	■	■	■	■
M4	■	■	■	■	■	■	■	■	■	■	■	■	■	■	■
K1	■	■	■	■	■	■	■	■	■	■	■	■	■	■	■
K2	■	■	■	■	■	■	■	■	■	■	■	■	■	■	■
K3	■	■	■	■	■	■	■	■	■	■	■	■	■	■	■
K4	■	■	■	■	■	■	■	■	■	■	■	■	■	■	■
K5	■	■	■	■	■	■	■	■	■	■	■	■	■	■	■
N1	■	■	■	■	■	■	■	■	■	■	■	■	■	■	■
N2	■	■	■	■	■	■	■	■	■	■	■	■	■	■	■
N3	■	■	■	■	■	■	■	■	■	■	■	■	■	■	■
N4	■	■	■	■	■	■	■	■	■	■	■	■	■	■	■
N5															
S1	■	■	■	■	■	■	■	■	■	■	■	■	■	■	■
S2	■	■	■	■	■	■	■	■	■	■	■	■	■	■	■
S3	■	■	■	■	■	■	■	■	■	■	■	■	■	■	■
S4	■	■	■	■	■	■	■	■	■	■	■	■	■	■	■
H1															
H2															
H3															
H4															



Código de Material (BMC)		HSS-E	HSS-E	HSS	HSS	HSS	HSS	HSS
Grupo básico estándar (BSG)		DIN 333R	DORNER	DIN ANSI	DIN 338	DIN 338	DIN 338	DIN 338
Longitud Útil (ULDR)		1xD	1xD	2.5xD	4xD	4xD	4xD	4xD
Ángulo de aplicación		R	60°	135°	118°	118°	118°	118°
Recubrimiento		Bright	Bright	TiN-Tip	TiN-Tip	TiN-Tip	TiN-Tip	TiN-Tip
Mango		H						
Forma de la Hélice				λ 20-35°	λ 20-35°	λ 20-35°	λ 20-35°	λ 20-35°
Mano (dirección de corte)		R	R	R	R	R	R	R
Refrigeración (CSP)								
Código de Familia de Producto		A238	A242	A088	A095	A087	A094	A089
		1.60 - 8.00	1.00 - 5.00	Set	Set	Set	Set	Set
		163	164	165	165	166	166	167
P	P1	■	■					
	P2	■	■					
	P3	■	■					
	P4	☑	☑					
M	M1	☑	☑					
	M2	☑	☑					
	M3	☑	☑					
	M4	☑	☑					
K	K1	■	■					
	K2	☑	☑					
	K3	☑	☑					
	K4	☑	☑					
	K5	☑	☑					
N	N1	☑	☑					
	N2	☑	☑					
	N3	☑	☑					
	N4	☑	☑					
	N5							
S	S1	☑	☑					
	S2	☑	☑					
	S3	☑	☑					
	S4	☑	☑					
H	H1							
	H2							
	H3							
	H4							

■ Primera Opción ☑ Opción Alternativa



A099	A099	A199	A080	A190
-------------	-------------	-------------	-------------	-------------

Set	Drillboy	Set	Set	Set
-----	----------	-----	-----	-----

168	168	169	169	170
-----	-----	-----	-----	-----

P1				
P2				
P3				
P4				
M1				
M2				
M3				
M4				
K1				
K2				
K3				
K4				
K5				
N1				
N2				
N3				
N4				
N5				
S1				
S2				
S3				
S4				
H1				
H2				
H3				
H4				



		HSS	HSS	HSS	HSS-E		
Código de Material (BMC)		HSS	HSS	HSS	HSS-E		
Grupo básico estándar (BSG)		DIN 338	DIN 338	DIN 338	DIN 338		
Longitud Útil (ULDR)		4xD	4xD	4xD	4xD		
Ángulo de aplicación		118°	118°	135°	135°	60°	
Recubrimiento		ST	ST	ST	Bronze		
Mango							
Forma de la Hélice		λ 20-35°	λ 20-35°	λ >35°	λ 20-35°		
Mano (dirección de corte)		R	R	R	R		
Refrigeración (CSP)							
Código de Familia de Producto		A191	A191	A188	A295	A296	M150
		Set	Set	Set	Set	Set	
		171	171	172	172	173	173
P	P1						
	P2						
	P3						
	P4						
M	M1						
	M2						
	M3						
	M4						
K	K1						
	K2						
	K3						
	K4						
	K5						
N	N1						
	N2						
	N3						
	N4						
	N5						
S	S1						
	S2						
	S3						
	S4						
H	H1						
	H2						
	H3						
	H4						



M152

174

P1
P2
P3
P4
M1
M2
M3
M4
K1
K2
K3
K4
K5
N1
N2
N3
N4
N5
S1
S2
S3
S4
H1
H2
H3
H4



A723



Broca HSS-E (5% Cobalto), para Puntos de Soldadura, Acabado Bronce

Broca con punto central y filos especialmente diseñados para eliminar o "soltar" áreas soldadas por puntos, normalmente para quitar soldaduras en un taller de reparación de vehículos. La corta longitud de los canales la hace más resistente y menos propensa a romperse cuando se usa en un dispositivo manual. El acabado bronce consiste en una fina capa de óxido y es un indicativo de cobalto.

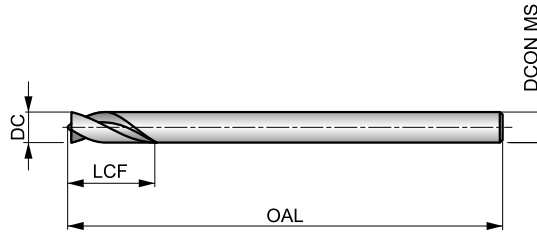

HSS-E	DORMER	1xD
Bronze		20-35°
R	DC h8	

Grupo de Material de la pieza adecuado y condiciones de velocidad de corte iniciales (m/min) y código de avance alfabético. Tablas con avance por revolución a partir de la pag.175.

Producto	DC (mm)	DC (inch)	LCF (mm)	OAL (mm)	DCON MS (mm)
P1.1 ■ 33 D					
P1.2 ■ 37 D					
P1.3 ■ 38 D					
P2.1 ■ 28 D					
P2.2 ■ 25 C					
P3.1 ■ 20 C					
P3.2 ■ 20 C					
P4.1 ■ 20 C					
A7236.0X66	6.00	0.2362	18.0	66.0	6.00
A7236.0X93	6.00	0.2362	18.0	93.0	6.00
A7238.0X79	8.00	0.3150	24.0	79.0	8.00
A7238.0X117	8.00	0.3150	24.0	117.0	8.00



A119



Broca HSS Extra Corta, Doble Punta, Acabado Templado al Vapor. Broca para Chapas.

Una broca corta de doble punta diseñada para taladrar agujeros en chapa. Posibilidad de utilizar ambos extremos, ofreciendo el doble de vida útil. Punta convencional a 120° para mejorar al autocentrado. Adecuadas para taladrar en la mayoría de materiales. El acabado templado al vapor retiene el fluido de corte y evita que la viruta se suelde a la herramienta.

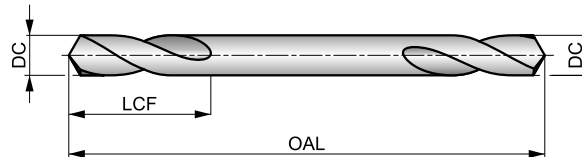

HSS	DIN 1897	1.25xD
120°	ST	
20-35°	R	DC h8

Grupo de Material de la pieza adecuado y condiciones de velocidad de corte iniciales (m/min) y código de avance alfabético. Tablas con avance por revolución a partir de la pag.175.

P1.1 ■ 31 C	P1.2 ■ 34 C	P1.3 ■ 35 C	P2.1 ■ 26 C	P2.2 ■ 23 C	P2.3 ■ 20 C	P3.1 ■ 12 C	P3.2 ■ 9 C	P3.3 ■ 8 C	P4.1 ■ 7 C	P4.2 ■ 6 C	P4.3 ■ 5 A	M1.1 ■ 21 A	M1.2 ■ 17 A
M2.1 ■ 18 A	M2.2 ■ 15 A	M3.1 ■ 8 C	M3.2 ■ 7 C	M3.3 ■ 6 C	M4.1 ■ 10 A	N1.1 ■ 33 C	N1.2 ■ 25 C	N1.3 ■ 17 C	N2.1 ■ 46 C	N2.2 ■ 42 C	N2.3 ■ 30 C	N3.1 ■ 56 C	N3.2 ■ 33 C
N3.3 ■ 17 A	N4.1 ■ 30 I	N4.2 ■ 35 C	S1.1 ■ 27 A	S1.2 ■ 12 A	S1.3 ■ 7 A	S2.1 ■ 5 C	S2.2 ■ 4 C	S3.1 ■ 4 C	S3.2 ■ 3 C	S4.1 ■ 3 C	S4.2 ■ 2 C		

Broca para chapas

Producto	DC	DC	LCF	OAL	DCON MS
	(mm)	(inch)	(mm)	(mm)	(mm)
A1193.3	3.30	0.1299	11.0	49.0	3.30
A1193.6	3.60	0.1417	12.0	52.0	3.60
A1194.1	4.10	0.1614	14.0	55.0	4.10
A1194.2	4.20	0.1654	14.0	55.0	4.20
A1194.9	4.90	0.1929	17.0	62.0	4.90
A1195.1	5.10	0.2008	17.0	62.0	5.10



A122



Broca de Centrar HSS, Acabado Brillante

Esta broca se utiliza para crear un agujero en el material que se va a taladrar para garantizar que el punto de inicio sea preciso. Esta disponible con un ángulo de punta de 90° o 120°, lo que le ofrece dos opciones de punteado. Acabado brillante. Adecuada para taladrar en la mayoría de materiales.

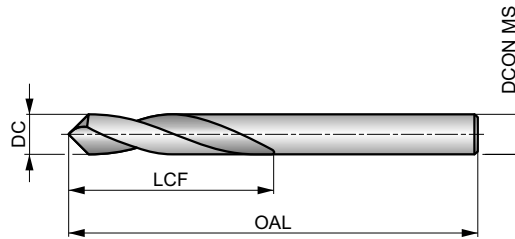

HSS	DIN 1897	1xD
90°/120°	Bright	
λ 20-35°	R	DC h8

Grupo de Material de la pieza adecuado y condiciones de velocidad de corte iniciales (m/min) y código de avance alfabético. Tablas con avance por revolución a partir de la pag.175.

P1.1 ■ 36 E	P1.2 ■ 40 E	P1.3 ■ 41 E	P2.1 ■ 31 E	P2.2 ■ 27 C	P2.3 ■ 24 C	P3.1 ■ 21 C	P3.2 ■ 17 C	P3.3 ■ 14 C	P4.1 ■ 12 C	P4.2 ■ 10 C	P4.3 ■ 9 B	M1.1 ■ 22 C	M1.2 ■ 19 C
M2.1 ■ 20 C	M2.2 ■ 16 C	M3.1 ■ 10 D	M3.2 ■ 9 D	M3.3 ■ 8 D	M4.1 ■ 10 B	K1.1 ■ 32 E	K1.2 ■ 24 C	K1.3 ■ 18 C	K2.1 ■ 25 C	K2.2 ■ 20 C	K2.3 ■ 16 B	K3.1 ■ 22 C	K3.2 ■ 17 C
K3.3 ■ 13 B	K4.1 ■ 20 C	K4.2 ■ 15 C	K4.3 ■ 11 B	K4.4 ■ 10 B	K4.5 ■ 8 B	K5.1 ■ 23 C	K5.2 ■ 17 C	K5.3 ■ 13 B	N1.1 ■ 33 E	N1.2 ■ 25 E	N1.3 ■ 17 E	N2.1 ■ 46 D	N2.2 ■ 42 D
N2.3 ■ 30 D	N3.1 ■ 56 D	N3.2 ■ 33 E	N3.3 ■ 17 D	N4.1 ■ 30 F	N4.2 ■ 35 E	N4.3 ■ 17 D	S1.1 ■ 27 C	S1.2 ■ 12 B	S1.3 ■ 7 A	S2.1 ■ 11 C	S2.2 ■ 6 A	S3.1 ■ 8 C	S3.2 ■ 4 A
S4.1 ■ 6 C	S4.2 ■ 3 A												

Producto	DC	DC	LCF	OAL	DCON MS
	(mm)	(inch)			
A1226.0X90	6.00	0.2362	30.0	66.0	6.00
A1226.0X120	6.00	0.2362	30.0	66.0	6.00
A1228.0X90	8.00	0.3150	33.0	79.0	8.00
A1228.0X120	8.00	0.3150	33.0	79.0	8.00
A12210.0X90	10.00	0.3937	35.0	89.0	10.00
A12210.0X120	10.00	0.3937	35.0	89.0	10.00
A12212.0X90	12.00	0.4724	40.0	102.0	12.00
A12212.0X120	12.00	0.4724	40.0	102.0	12.00
A12216.0X90	16.00	0.6299	40.0	115.0	16.00
A12216.0X120	16.00	0.6299	40.0	115.0	16.00
A12220.0X90	20.00	0.7874	55.0	131.0	20.00
A12220.0X120	20.00	0.7874	55.0	131.0	20.00



A123



Broca HSS Serie Extra Corta para Chapas Metálicas, Acabado Templado al Vapor

Especialmente diseñada para taladrar piezas delgadas y chapas. Punta de 120° y acabado templado al vapor que evita que el material de la pieza se adhiera al filo, lo que proporciona un mejor acabado del agujero y un diámetro más preciso. Adecuada para taladrar en muchos materiales.

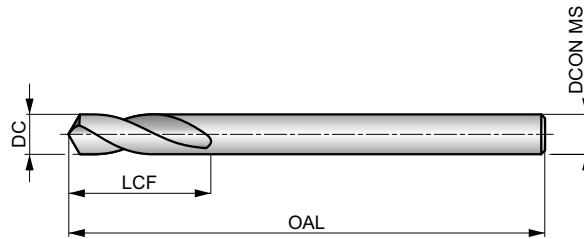

HSS	DIN 1897	1.5×D
120°	ST	
20-35°	R	DC h8

Grupo de Material de la pieza adecuado y condiciones de velocidad de corte iniciales (m/min) y código de avance alfabético. Tablas con avance por revolución a partir de la pag.175.

P1.1 ■ 36 E	P1.2 ■ 40 E	P1.3 ■ 41 E	P2.1 ■ 31 E	P2.2 ■ 27 C	P2.3 ■ 24 C	P3.1 ■ 21 C	P3.2 ■ 17 C	P3.3 ■ 14 C	P4.1 ■ 12 C	P4.2 ■ 10 C	P4.3 ■ 9 B	M1.1 ■ 22 C	M1.2 ■ 19 C
M2.1 ■ 20 C	M2.2 ■ 16 C	M3.1 ■ 10 D	M3.2 ■ 9 D	M3.3 ■ 8 D	M4.1 ■ 10 B	N1.1 ■ 33 E	N1.2 ■ 25 E	N1.3 ■ 17 E	N2.1 ■ 46 D	N2.2 ■ 42 D	N2.3 ■ 30 D	N3.1 ■ 56 D	N3.2 ■ 33 E
N3.3 ■ 17 D	N4.1 ■ 30 F	N4.2 ■ 35 E	N4.3 ■ 17 D	S1.1 ■ 27 C	S1.2 ■ 12 B	S1.3 ■ 7 A	S2.1 ■ 11 C	S2.2 ■ 6 A	S3.1 ■ 8 C	S3.2 ■ 4 A	S4.1 ■ 6 C	S4.2 ■ 3 A	

Broca para chapas

Producto	DC	DC	DC	LCF	OAL	DCON MS
	(inch)	(mm)	(inch)			
A1233/32S	3/32	2.38	0.0937	14.0	43.0	2.38
A1232.5S	—	2.50	0.0984	14.0	43.0	2.50
A1233.0S	—	3.00	0.1181	16.0	46.0	3.00
A1231/8S	1/8	3.18	0.1252	18.0	49.0	3.18
A1233.2S	—	3.20	0.1260	18.0	49.0	3.20
A1233.3S	—	3.30	0.1299	18.0	49.0	3.30
A1233.5S	—	3.50	0.1378	18.0	52.0	3.50
A1233.7S	—	3.70	0.1457	18.0	52.0	3.70
A1235/32S	5/32	3.97	0.1563	18.0	55.0	3.97
A1234.0S	—	4.00	0.1575	18.0	55.0	4.00
A1234.1S	—	4.10	0.1614	18.0	55.0	4.10
A1234.2S	—	4.20	0.1654	18.0	55.0	4.20
A1234.5S	—	4.50	0.1772	18.0	58.0	4.50
A1233/16S	3/16	4.76	0.1875	18.0	62.0	4.76
A1234.8S	—	4.80	0.1890	18.0	62.0	4.80
A1234.9S	—	4.90	0.1929	18.0	62.0	4.90
A1235.0S	—	5.00	0.1969	18.0	62.0	5.00
A1235.5S	—	5.50	0.2165	18.0	66.0	5.50
A1237/32S	7/32	5.56	0.2188	18.0	66.0	5.56
A1236.0S	—	6.00	0.2362	18.0	66.0	6.00
A1231/4S	1/4	6.35	0.2500	19.0	70.0	6.35



A120



Broca HSS Serie Extra Corta, Acabado Templado al Vapor

Broca versátil con acabado templado al vapor. La punta dividida a 135° reduce las fuerzas al taladrar y evita que la broca se desplace sobre la superficie del material. El acabado templado al vapor retiene el fluido de corte y evita la soldadura de la viruta a la herramienta. Apta para taladrar muchos materiales tanto en taladros manuales como en máquinas.

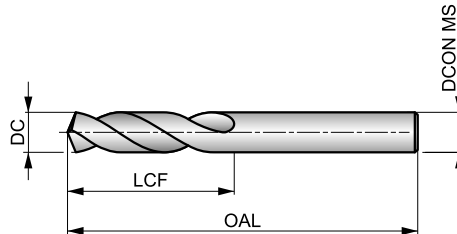

HSS	DIN 1897	2.5×D
135°	ST	
λ 20-35°	R	DC h8

Grupo de Material de la pieza adecuado y condiciones de velocidad de corte iniciales (m/min) y código de avance alfabético. Tablas con avance por revolución a partir de la pag.175.

P1.1 ■ 36 J	P1.2 ■ 40 J	P1.3 ■ 41 J	P2.1 ■ 31 J	P2.2 ■ 27 G	P2.3 ■ 24 F	P3.1 ■ 21 G	P3.2 ■ 17 G	P3.3 ■ 14 F	P4.1 ■ 12 G	P4.2 ■ 10 F	P4.3 ■ 9 E	M1.1 ■ 22 F	M1.2 ■ 19 F
M2.1 ■ 20 F	M2.2 ■ 16 F	M3.1 ■ 10 H	M3.2 ■ 9 H	M3.3 ■ 8 H	M4.1 ■ 10 D	K1.1 ■ 32 J	K1.2 ■ 24 G	K1.3 ■ 18 G	K2.1 ■ 25 F	K2.2 ■ 20 F	K2.3 ■ 16 F	K3.1 ■ 22 F	K3.2 ■ 17 F
K3.3 ■ 13 F	K4.1 ■ 20 F	K4.2 ■ 15 F	K4.3 ■ 11 F	K4.4 ■ 10 F	K4.5 ■ 8 F	K5.1 ■ 23 F	K5.2 ■ 17 F	K5.3 ■ 13 F	N1.1 ■ 33 K	N1.2 ■ 25 K	N1.3 ■ 17 J	N2.1 ■ 46 I	N2.2 ■ 42 I
N2.3 ■ 30 I	N3.1 ■ 64 I	N3.2 ■ 38 J	N3.3 ■ 19 H	N4.1 ■ 30 K	N4.2 ■ 35 I	N4.3 ■ 17 G	S1.1 ■ 27 G	S1.2 ■ 16 E	S1.3 ■ 8 C	S2.1 ■ 11 F	S2.2 ■ 6 B	S3.1 ■ 8 F	S3.2 ■ 4 B
S4.1 ■ 6 F	S4.2 ■ 3 B												

DC <= 1mm Brillante; 2.9mm => DC >= 13.0mm Punta de 118°

Producto	DC (inch)	DC (mm)	DC (inch)	LCF (mm)	OAL (mm)	DCON MS (mm)
A120.5	-	0.50	0.0197	3.0	20.0	0.50
A120.6	-	0.60	0.0236	3.5	21.0	0.60
A120.7	-	0.70	0.0276	4.5	23.0	0.70
A1201/32	1/32	0.79	0.0313	5.0	24.0	0.79
A120.8	-	0.80	0.0315	5.0	24.0	0.80
A120.9	-	0.90	0.0354	5.5	25.0	0.90
A1201.0	-	1.00	0.0394	6.0	26.0	1.00
A1201.1	-	1.10	0.0433	7.0	28.0	1.10
A1203/64	3/64	1.19	0.0469	8.0	30.0	1.19
A1201.2	-	1.20	0.0472	8.0	30.0	1.20
A1201.3	-	1.30	0.0512	8.0	30.0	1.30
A1201.4	-	1.40	0.0551	9.0	32.0	1.40
A1201.5	-	1.50	0.0591	9.0	32.0	1.50
A1201/16	1/16	1.59	0.0625	10.0	34.0	1.59
A1201.6	-	1.60	0.0630	10.0	34.0	1.60
A1201.7	-	1.70	0.0669	10.0	34.0	1.70
A1201.8	-	1.80	0.0709	11.0	36.0	1.80
A1201.9	-	1.90	0.0748	11.0	36.0	1.90
A1205/64	5/64	1.98	0.0781	12.0	38.0	1.98
A1202.0	-	2.00	0.0787	12.0	38.0	2.00
A1202.1	-	2.10	0.0827	12.0	38.0	2.10
A1202.2	-	2.20	0.0866	13.0	40.0	2.20
A1202.25	-	2.25	0.0886	13.0	40.0	2.25

Producto	DC (inch)	DC (mm)	DC (inch)	LCF (mm)	OAL (mm)	DCON MS (mm)
A1202.3	-	2.30	0.0906	13.0	40.0	2.30
A1203/32	3/32	2.38	0.0938	14.0	43.0	2.38
A1202.4	-	2.40	0.0945	14.0	43.0	2.40
A1202.5	-	2.50	0.0984	14.0	43.0	2.50
A1202.6	-	2.60	0.1024	14.0	43.0	2.60
A1202.65	-	2.65	0.1043	14.0	43.0	2.65
A1202.7	-	2.70	0.1063	16.0	46.0	2.70
A1207/64	7/64	2.78	0.1094	16.0	46.0	2.78
A1202.8	-	2.80	0.1102	16.0	46.0	2.80
A1202.9	-	2.90	0.1142	16.0	46.0	2.90
A1203.0	-	3.00	0.1181	16.0	46.0	3.00
A1203.1	-	3.10	0.1220	18.0	49.0	3.10
A1201/8	1/8	3.18	0.1252	18.0	49.0	3.18
A1203.2	-	3.20	0.1260	18.0	49.0	3.20
A1203.25	-	3.25	0.1280	18.0	49.0	3.25
A1203.3	-	3.30	0.1299	18.0	49.0	3.30
A1203.4	-	3.40	0.1339	20.0	52.0	3.40
A1203.5	-	3.50	0.1378	20.0	52.0	3.50
A1209/64	9/64	3.57	0.1406	20.0	52.0	3.57
A1203.6	-	3.60	0.1417	20.0	52.0	3.60
A1203.7	-	3.70	0.1457	20.0	52.0	3.70
A1203.8	-	3.80	0.1496	22.0	55.0	3.80
A1203.9	-	3.90	0.1535	22.0	55.0	3.90



Producto	DC	DC	DC	LCF	OAL	D CON MS
	(inch)	(mm)	(inch)	(mm)	(mm)	(mm)
A1205/32	5/32	3.97	0.1563	22.0	55.0	3.97
A1204.0	–	4.00	0.1575	22.0	55.0	4.00
A1204.1	–	4.10	0.1614	22.0	55.0	4.10
A1204.2	–	4.20	0.1654	22.0	55.0	4.20
A1204.3	–	4.30	0.1693	24.0	58.0	4.30
A12011/64	11/64	4.37	0.1719	24.0	58.0	4.37
A1204.4	–	4.40	0.1732	24.0	58.0	4.40
A1204.5	–	4.50	0.1772	24.0	58.0	4.50
A1204.6	–	4.60	0.1811	24.0	58.0	4.60
A1204.7	–	4.70	0.1850	24.0	58.0	4.70
A1203/16	3/16	4.76	0.1875	26.0	62.0	4.76
A1204.8	–	4.80	0.1890	26.0	62.0	4.80
A1204.9	–	4.90	0.1929	26.0	62.0	4.90
A1205.0	–	5.00	0.1969	26.0	62.0	5.00
A1205.1	–	5.10	0.2008	26.0	62.0	5.10
A12013/64	13/64	5.16	0.2031	26.0	62.0	5.16
A1205.2	–	5.20	0.2047	26.0	62.0	5.20
A1205.3	–	5.30	0.2087	26.0	62.0	5.30
A1205.4	–	5.40	0.2126	28.0	66.0	5.40
A1205.5	–	5.50	0.2165	28.0	66.0	5.50
A1207/32	7/32	5.56	0.2188	28.0	66.0	5.56
A1205.6	–	5.60	0.2205	28.0	66.0	5.60
A1205.7	–	5.70	0.2244	28.0	66.0	5.70
A1205.8	–	5.80	0.2283	28.0	66.0	5.80
A1205.9	–	5.90	0.2323	28.0	66.0	5.90
A12015/64	15/64	5.95	0.2344	28.0	66.0	5.95
A1206.0	–	6.00	0.2362	28.0	66.0	6.00
A1206.1	–	6.10	0.2402	31.0	70.0	6.10
A1206.2	–	6.20	0.2441	31.0	70.0	6.20
A1206.3	–	6.30	0.2480	31.0	70.0	6.30
A1201/4	1/4	6.35	0.2500	31.0	70.0	6.35
A1206.4	–	6.40	0.2520	31.0	70.0	6.40
A1206.5	–	6.50	0.2559	31.0	70.0	6.50
A1206.6	–	6.60	0.2598	31.0	70.0	6.60
A1206.7	–	6.70	0.2638	31.0	70.0	6.70
A1206.8	–	6.80	0.2677	34.0	74.0	6.80
A1206.9	–	6.90	0.2717	34.0	74.0	6.90
A1207.0	–	7.00	0.2756	34.0	74.0	7.00
A1207.1	–	7.10	0.2795	34.0	74.0	7.10
A1209/32	9/32	7.14	0.2813	34.0	74.0	7.14
A1207.2	–	7.20	0.2835	34.0	74.0	7.20
A1207.3	–	7.30	0.2874	34.0	74.0	7.30
A1207.4	–	7.40	0.2913	34.0	74.0	7.40
A1207.5	–	7.50	0.2953	34.0	74.0	7.50
A1207.6	–	7.60	0.2992	37.0	79.0	7.60
A1207.7	–	7.70	0.3031	37.0	79.0	7.70
A1207.8	–	7.80	0.3071	37.0	79.0	7.80
A1207.9	–	7.90	0.3110	37.0	79.0	7.90
A1205/16	5/16	7.94	0.3125	37.0	79.0	7.94
A1208.0	–	8.00	0.3150	37.0	79.0	8.00
A1208.1	–	8.10	0.3189	37.0	79.0	8.10
A1208.2	–	8.20	0.3228	37.0	79.0	8.20
A1208.3	–	8.30	0.3268	37.0	79.0	8.30
A1208.4	–	8.40	0.3307	37.0	79.0	8.40
A1208.5	–	8.50	0.3346	37.0	79.0	8.50
A1208.6	–	8.60	0.3386	40.0	84.0	8.60
A1208.7	–	8.70	0.3425	40.0	84.0	8.70
A12011/32	11/32	8.73	0.3438	40.0	84.0	8.73
A1208.8	–	8.80	0.3465	40.0	84.0	8.80
A1208.9	–	8.90	0.3504	40.0	84.0	8.90
A1209.0	–	9.00	0.3543	40.0	84.0	9.00
A1209.1	–	9.10	0.3583	40.0	84.0	9.10
A1209.2	–	9.20	0.3622	40.0	84.0	9.20
A1209.3	–	9.30	0.3661	40.0	84.0	9.30
A1209.4	–	9.40	0.3701	40.0	84.0	9.40

Producto	DC	DC	DC	LCF	OAL	D CON MS
	(inch)	(mm)	(inch)	(mm)	(mm)	(mm)
A1209.5	–	9.50	0.3740	40.0	84.0	9.50
A1203/8	3/8	9.52	0.3750	43.0	89.0	9.52
A1209.6	–	9.60	0.3780	43.0	89.0	9.60
A1209.7	–	9.70	0.3819	43.0	89.0	9.70
A1209.8	–	9.80	0.3858	43.0	89.0	9.80
A1209.9	–	9.90	0.3898	43.0	89.0	9.90
A12010.0	–	10.00	0.3937	43.0	89.0	10.00
A12010.1	–	10.10	0.3976	43.0	89.0	10.10
A12010.2	–	10.20	0.4016	43.0	89.0	10.20
A12010.3	–	10.30	0.4055	43.0	89.0	10.30
A12013/32	13/32	10.32	0.4063	43.0	89.0	10.32
A12010.4	–	10.40	0.4094	43.0	89.0	10.40
A12010.5	–	10.50	0.4134	43.0	89.0	10.50
A12010.6	–	10.60	0.4173	43.0	89.0	10.60
A12010.7	–	10.70	0.4213	47.0	95.0	10.70
A12010.8	–	10.80	0.4252	47.0	95.0	10.80
A12010.9	–	10.90	0.4291	47.0	95.0	10.90
A12011.0	–	11.00	0.4331	47.0	95.0	11.00
A12011.1	–	11.10	0.4370	47.0	95.0	11.10
A1207/16	7/16	11.11	0.4375	47.0	95.0	11.11
A12011.2	–	11.20	0.4409	47.0	95.0	11.20
A12011.3	–	11.30	0.4449	47.0	95.0	11.30
A12011.5	–	11.50	0.4528	47.0	95.0	11.50
A12011.6	–	11.60	0.4567	47.0	95.0	11.60
A12011.7	–	11.70	0.4606	47.0	95.0	11.70
A12011.8	–	11.80	0.4646	47.0	95.0	11.80
A12011.9	–	11.90	0.4685	51.0	102.0	11.90
A12012.0	–	12.00	0.4724	51.0	102.0	12.00
A12012.1	–	12.10	0.4764	51.0	102.0	12.10
A12012.2	–	12.20	0.4803	51.0	102.0	12.20
A12012.5	–	12.50	0.4921	51.0	102.0	12.50
A1201/2	1/2	12.70	0.5000	51.0	102.0	12.70
A12013.0	–	13.00	0.5118	51.0	102.0	13.00
A12013.5	–	13.50	0.5315	54.0	107.0	13.50
A12014.0	–	14.00	0.5512	54.0	107.0	14.00
A1209/16	9/16	14.29	0.5625	56.0	111.0	14.29
A12014.5	–	14.50	0.5709	56.0	111.0	14.50
A12015.0	–	15.00	0.5906	56.0	111.0	15.00
A12015.5	–	15.50	0.6102	58.0	115.0	15.50
A1205/8	5/8	15.88	0.6250	58.0	115.0	15.88
A12016.0	–	16.00	0.6299	58.0	115.0	16.00
A12016.5	–	16.50	0.6496	60.0	119.0	16.50
A12017.0	–	17.00	0.6693	60.0	119.0	17.00
A12011/16	11/16	17.46	0.6875	62.0	123.0	17.46
A12017.5	–	17.50	0.6890	62.0	123.0	17.50
A12018.0	–	18.00	0.7087	62.0	123.0	18.00
A12018.5	–	18.50	0.7283	64.0	127.0	18.50
A12019.0	–	19.00	0.7480	64.0	127.0	19.00
A1203/4	3/4	19.05	0.7500	66.0	131.0	19.05
A12019.5	–	19.50	0.7677	66.0	131.0	19.50
A12020.0	–	20.00	0.7874	66.0	131.0	20.00
A12020.5	–	20.50	0.8071	68.0	136.0	20.50
A12013/16	13/16	20.64	0.8125	68.0	136.0	20.64
A12021.0	–	21.00	0.8268	68.0	136.0	21.00
A12022.0	–	22.00	0.8661	70.0	141.0	22.00
A1207/8	7/8	22.22	0.8750	70.0	141.0	22.22
A12023.0	–	23.00	0.9055	72.0	146.0	23.00
A12015/16	15/16	23.81	0.9375	75.0	151.0	23.81
A12024.0	–	24.00	0.9449	75.0	151.0	24.00
A12025.0	–	25.00	0.9843	75.0	151.0	25.00



A022



Broca HSS Serie Extra Corta, con la Punta Recubierta TiN

Broca versátil con punta dividida a 135° especialmente diseñada para ayudar a autocentrar la broca cuando se taladra a mano y en máquina proporciona un agujero de tamaño más preciso y con mejor acabado superficial. Apta para muchos materiales. El recubrimiento TiN-Tip mejora el rendimiento y prolonga la vida útil de la herramienta.

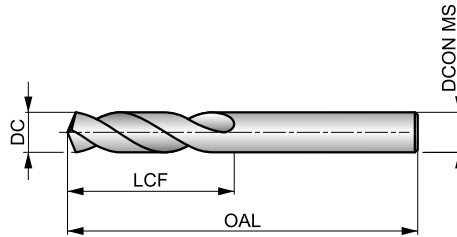

HSS	DIN ANSI	2.5×D
135°	TiN-Tip	
λ 20-35°	R	DC h8

Grupo de Material de la pieza adecuado y condiciones de velocidad de corte iniciales (m/min) y código de avance alfabético. Tablas con avance por revolución a partir de la pag.175.

P1.1 ■ 33 K	P1.2 ■ 37 K	P1.3 ■ 38 K	P2.1 ■ 28 K	P2.2 ■ 25 I	P2.3 ■ 22 G	P3.1 ■ 24 H	P3.2 ■ 19 H	P3.3 ■ 16 G	P4.1 ■ 14 H	P4.2 ■ 12 G	P4.3 ▣ 10 E	M1.1 ■ 21 G	M1.2 ■ 17 G
M2.1 ■ 18 G	M2.2 ■ 15 G	M3.1 ▣ 9 I	M3.2 ▣ 8 I	M3.3 ▣ 7 I	M4.1 ▣ 9 E	K1.1 ■ 32 K	K1.2 ■ 24 I	K1.3 ■ 18 I	K2.1 ■ 25 G	K2.2 ■ 20 G	K2.3 ▣ 16 G	K3.1 ■ 22 G	K3.2 ■ 17 G
K3.3 ▣ 13 G	K4.1 ■ 20 G	K4.2 ■ 15 G	K4.3 ▣ 11 G	K4.4 ▣ 10 G	K4.5 ▣ 8 G	K5.1 ■ 23 G	K5.2 ■ 17 G	K5.3 ▣ 13 G	N1.1 ■ 40 F	N1.2 ■ 30 F	N1.3 ■ 20 K	N2.1 ■ 49 J	N2.2 ■ 44 J
N2.3 ■ 32 J	N3.1 ▣ 64 I	N3.2 ▣ 38 K	N3.3 ▣ 19 H	N4.1 ▣ 30 K	N4.2 ▣ 35 I	N4.3 ▣ 17 G	S1.1 ■ 25 I	S1.2 ▣ 14 F	S1.3 ▣ 8 C	S2.1 ▣ 11 F	S2.2 ▣ 6 B	S3.1 ▣ 8 F	S3.2 ▣ 4 B
S4.1 ▣ 6 F	S4.2 ▣ 3 B												

DC < 2mm Brillante; DC >= 2mm Punta rectificada en cruz y recubierta TiN
Los productos de esta serie también están disponibles en forma de Set. Por favor, vea A088.

Producto	DC (inch)	DC (mm)	DC (inch)	LCF (mm)	OAL (mm)	DCON MS (mm)
A022.5	-	0.50	0.0197	3.0	20.0	0.50
A022.6	-	0.60	0.0236	3.5	21.0	0.60
A022.7	-	0.70	0.0276	4.5	23.0	0.70
A0221/32	1/32	0.79	0.0313	13.0	35.0	0.79
A022.8	-	0.80	0.0315	5.0	24.0	0.80
A022.9	-	0.90	0.0354	5.5	25.0	0.90
A0221.0	-	1.00	0.0394	6.0	26.0	1.00
A0221.1	-	1.10	0.0433	7.0	28.0	1.10
A0223/64	3/64	1.19	0.0469	13.0	35.0	1.19
A0221.2	-	1.20	0.0472	8.0	30.0	1.20
A0221.3	-	1.30	0.0512	8.0	30.0	1.30
A0221.4	-	1.40	0.0551	9.0	32.0	1.40
A0221.5	-	1.50	0.0591	9.0	32.0	1.50
A0221/16	1/16	1.59	0.0625	16.0	41.0	1.59
A0221.6	-	1.60	0.0630	10.0	34.0	1.60
A0221.7	-	1.70	0.0669	10.0	34.0	1.70
A0221.8	-	1.80	0.0709	11.0	36.0	1.80
A0221.9	-	1.90	0.0748	11.0	36.0	1.90
A0225/64	5/64	1.98	0.0781	17.0	43.0	1.98
A0222.0	-	2.00	0.0787	12.0	38.0	2.00
A0222.1	-	2.10	0.0827	12.0	38.0	2.10
A0222.2	-	2.20	0.0866	13.0	40.0	2.20

Producto	DC (inch)	DC (mm)	DC (inch)	LCF (mm)	OAL (mm)	DCON MS (mm)
A0222.25	-	2.25	0.0886	13.0	40.0	2.25
A0222.3	-	2.30	0.0906	13.0	40.0	2.30
A0223/32	3/32	2.38	0.0938	20.0	45.0	2.38
A0222.4	-	2.40	0.0945	14.0	43.0	2.40
A0222.5	-	2.50	0.0984	14.0	43.0	2.50
A0222.6	-	2.60	0.1024	14.0	43.0	2.60
A0222.65	-	2.65	0.1043	14.0	43.0	2.65
A0222.7	-	2.70	0.1063	16.0	46.0	2.70
A0227/64	7/64	2.78	0.1094	22.0	47.0	2.78
A0222.8	-	2.80	0.1102	16.0	46.0	2.80
A0222.9	-	2.90	0.1142	16.0	46.0	2.90
A0223.0	-	3.00	0.1181	16.0	46.0	3.00
A0223.1	-	3.10	0.1220	18.0	49.0	3.10
A0221/8	1/8	3.18	0.1250	23.0	49.0	3.18
A0223.2	-	3.20	0.1260	18.0	49.0	3.20
A0223.25	-	3.25	0.1280	18.0	49.0	3.25
A0223.3	-	3.30	0.1299	18.0	49.0	3.30
A0223.4	-	3.40	0.1339	20.0	52.0	3.40
A0223.5	-	3.50	0.1378	20.0	52.0	3.50
A0229/64	9/64	3.57	0.1406	25.0	50.0	3.57
A0223.6	-	3.60	0.1417	20.0	52.0	3.60
A0223.7	-	3.70	0.1457	20.0	52.0	3.70



Producto	DC	DC	DC	LCF	OAL	D CON MS
	(inch)	(mm)	(inch)	(mm)	(mm)	(mm)
A0223.8	–	3.80	0.1496	22.0	55.0	3.80
A0223.9	–	3.90	0.1535	22.0	55.0	3.90
A0225/32	5/32	3.97	0.1563	26.0	53.0	3.97
A0224.0	–	4.00	0.1575	22.0	55.0	4.00
A0224.1	–	4.10	0.1614	22.0	55.0	4.10
A0224.2	–	4.20	0.1654	22.0	55.0	4.20
A0224.3	–	4.30	0.1693	24.0	58.0	4.30
A02211/64	11/64	4.37	0.1719	28.0	55.0	4.37
A0224.4	–	4.40	0.1732	24.0	58.0	4.40
A0224.5	–	4.50	0.1772	24.0	58.0	4.50
A0224.6	–	4.60	0.1811	24.0	58.0	4.60
A0224.7	–	4.70	0.1850	24.0	58.0	4.70
A0223/16	3/16	4.76	0.1875	30.0	57.0	4.76
A0224.8	–	4.80	0.1890	26.0	62.0	4.80
A0224.9	–	4.90	0.1929	26.0	62.0	4.90
A0225.0	–	5.00	0.1969	26.0	62.0	5.00
A0225.1	–	5.10	0.2008	26.0	62.0	5.10
A02213/64	13/64	5.16	0.2031	31.0	58.0	5.16
A0225.2	–	5.20	0.2047	26.0	62.0	5.20
A0225.3	–	5.30	0.2087	26.0	62.0	5.30
A0225.4	–	5.40	0.2126	28.0	66.0	5.40
A0225.5	–	5.50	0.2165	28.0	66.0	5.50
A0227/32	7/32	5.56	0.2188	33.0	61.0	5.56
A0225.6	–	5.60	0.2205	28.0	66.0	5.60
A0225.7	–	5.70	0.2244	28.0	66.0	5.70
A0225.8	–	5.80	0.2283	28.0	66.0	5.80
A0225.9	–	5.90	0.2323	28.0	66.0	5.90
A02215/64	15/64	5.95	0.2344	34.0	63.0	5.95
A0226.0	–	6.00	0.2362	28.0	66.0	6.00
A0226.1	–	6.10	0.2402	31.0	70.0	6.10
A0226.2	–	6.20	0.2441	31.0	70.0	6.20
A0226.3	–	6.30	0.2480	31.0	70.0	6.30
A0221/4	1/4	6.35	0.2500	36.0	65.0	6.35
A0226.4	–	6.40	0.2520	31.0	70.0	6.40
A0226.5	–	6.50	0.2559	31.0	70.0	6.50
A0226.6	–	6.60	0.2598	31.0	70.0	6.60
A0226.7	–	6.70	0.2638	31.0	70.0	6.70
A0226.8	–	6.80	0.2677	34.0	74.0	6.80
A0226.9	–	6.90	0.2717	34.0	74.0	6.90
A0227.0	–	7.00	0.2756	34.0	74.0	7.00
A0227.1	–	7.10	0.2795	34.0	74.0	7.10
A0229/32	9/32	7.14	0.2813	40.0	70.0	7.14
A0227.2	–	7.20	0.2835	34.0	74.0	7.20
A0227.3	–	7.30	0.2874	34.0	74.0	7.30
A0227.4	–	7.40	0.2913	34.0	74.0	7.40
A0227.5	–	7.50	0.2953	34.0	74.0	7.50
A0227.6	–	7.60	0.2992	37.0	79.0	7.60
A0227.7	–	7.70	0.3031	37.0	79.0	7.70
A0227.8	–	7.80	0.3071	37.0	79.0	7.80
A0227.9	–	7.90	0.3110	37.0	79.0	7.90
A0225/16	5/16	7.94	0.3125	43.0	73.0	7.94
A0228.0	–	8.00	0.3150	37.0	79.0	8.00
A0228.1	–	8.10	0.3189	37.0	79.0	8.10
A0228.2	–	8.20	0.3228	37.0	79.0	8.20

Producto	DC	DC	DC	LCF	OAL	D CON MS
	(inch)	(mm)	(inch)	(mm)	(mm)	(mm)
A0228.3	–	8.30	0.3268	37.0	79.0	8.30
A0228.4	–	8.40	0.3307	37.0	79.0	8.40
A0228.5	–	8.50	0.3346	37.0	79.0	8.50
A0228.6	–	8.60	0.3386	40.0	84.0	8.60
A0228.7	–	8.70	0.3425	40.0	84.0	8.70
A02211/32	11/32	8.73	0.3438	45.0	78.0	8.73
A0228.8	–	8.80	0.3465	40.0	84.0	8.80
A0228.9	–	8.90	0.3504	40.0	84.0	8.90
A0229.0	–	9.00	0.3543	40.0	84.0	9.00
A0229.1	–	9.10	0.3583	40.0	84.0	9.10
A0229.2	–	9.20	0.3622	40.0	84.0	9.20
A0229.3	–	9.30	0.3661	40.0	84.0	9.30
A0229.4	–	9.40	0.3701	40.0	84.0	9.40
A0229.5	–	9.50	0.3740	40.0	84.0	9.50
A0223/8	3/8	9.52	0.3750	48.0	81.0	9.52
A0229.6	–	9.60	0.3780	43.0	89.0	9.60
A0229.7	–	9.70	0.3819	43.0	89.0	9.70
A0229.8	–	9.80	0.3858	43.0	89.0	9.80
A0229.9	–	9.90	0.3898	43.0	89.0	9.90
A02210.0	–	10.00	0.3937	43.0	89.0	10.00
A02210.1	–	10.10	0.3976	43.0	89.0	10.10
A02210.2	–	10.20	0.4016	43.0	89.0	10.20
A02210.3	–	10.30	0.4055	43.0	89.0	10.30
A02213/32	13/32	10.32	0.4063	51.0	86.0	10.32
A02210.4	–	10.40	0.4094	43.0	89.0	10.40
A02210.5	–	10.50	0.4134	43.0	89.0	10.50
A02210.6	–	10.60	0.4173	43.0	89.0	10.60
A02210.7	–	10.70	0.4213	47.0	95.0	10.70
A02210.8	–	10.80	0.4252	47.0	95.0	10.80
A02210.9	–	10.90	0.4291	47.0	95.0	10.90
A02211.0	–	11.00	0.4331	47.0	95.0	11.00
A02211.1	–	11.10	0.4370	47.0	95.0	11.10
A0227/16	7/16	11.11	0.4375	54.0	89.0	11.11
A02211.2	–	11.20	0.4409	47.0	95.0	11.20
A02211.3	–	11.30	0.4449	47.0	95.0	11.30
A02211.5	–	11.50	0.4528	47.0	95.0	11.50
A02211.6	–	11.60	0.4567	47.0	95.0	11.60
A02211.7	–	11.70	0.4606	47.0	95.0	11.70
A02211.8	–	11.80	0.4646	47.0	95.0	11.80
A02211.9	–	11.90	0.4685	51.0	102.0	11.90
A02212.0	–	12.00	0.4724	51.0	102.0	12.00
A02212.1	–	12.10	0.4764	51.0	102.0	12.10
A02212.2	–	12.20	0.4803	51.0	102.0	12.20
A02212.5	–	12.50	0.4921	51.0	102.0	12.50
A0221/2	1/2	12.70	0.5000	60.0	98.0	12.70
A02213.0	–	13.00	0.5118	51.0	102.0	13.00
A02213.5	–	13.50	0.5315	54.0	107.0	13.50
A02214.0	–	14.00	0.5512	54.0	107.0	14.00
A0229/16	9/16	14.29	0.5625	67.0	105.0	14.29
A02214.5	–	14.50	0.5709	56.0	111.0	14.50
A02215.0	–	15.00	0.5906	56.0	111.0	15.00
A02215.5	–	15.50	0.6102	58.0	115.0	15.50
A0225/8	5/8	15.88	0.6250	73.0	111.0	15.88
A02216.0	–	16.00	0.6299	58.0	115.0	16.00



A620



Broca HSS-E (5% Cobalto), Serie Extra Corta, Acabado Bronce

Broca con un ángulo de 130° que mejora el auto-centrado y reduce las fuerzas de corte. El acabado bronce consiste en una fina capa de óxido y es un indicativo de cobalto. Adecuada para taladrar en muchos materiales. No debe usarse en máquinas portátiles.

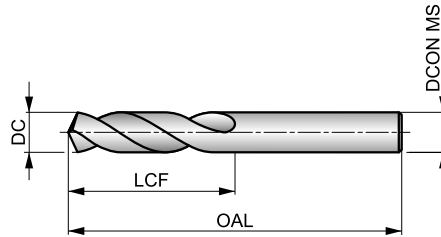

HSS-E	DIN 1897	2.5×D
130°	Bronze	
λ 20-35°	R	DC h8

Grupo de Material de la pieza adecuado y condiciones de velocidad de corte iniciales (m/min) y código de avance alfabético. Tablas con avance por revolución a partir de la pag.175.

P1.1 □40 H	P1.2 □45 H	P1.3 □46 H	P2.1 □34 H	P2.2 □30 G	P2.3 □27 F	P3.1 □27 G	P3.2 □21 G	P3.3 □18 F	P4.1 □16 G	P4.2 □13 F	P4.3 □11 E	M1.1 ■30 F	M1.2 ■26 F
M2.1 ■27 F	M2.2 ■22 F	M3.1 ■13 H	M3.2 ■11 H	M3.3 ■10 H	M4.1 ■15 D	K1.1 □34 K	K1.2 □25 F	K1.3 □19 F	K2.1 □27 F	K2.2 □22 F	K2.3 □18 F	K3.1 □24 F	K3.2 □18 F
K3.3 □15 F	K4.1 □22 F	K4.2 □17 F	K4.3 □12 F	K4.4 □11 F	K4.5 □9 F	K5.1 □25 F	K5.2 □19 F	K5.3 □15 F	N1.1 □40 K	N1.2 □30 K	N1.3 □20 J	N2.1 □49 I	N2.2 □44 I
N2.3 □32 I	N3.1 □68 J	N3.2 □40 K	N3.3 □20 I	N4.1 □40 L	N4.2 □32 K	N4.3 □18 I	S1.1 □30 G	S1.2 □18 F	S1.3 □10 C	S2.1 □12 F	S2.2 □8 C	S3.1 □9 F	S3.2 □6 C
S4.1 □7 F	S4.2 □5 C												

Producto	DC (mm)	DC (inch)	LCF (mm)	OAL (mm)	DCON MS (mm)
A6202.5	2.50	0.0984	14.0	43.0	2.50
A6202.6	2.60	0.1024	14.0	43.0	2.60
A6202.7	2.70	0.1063	16.0	46.0	2.70
A6202.8	2.80	0.1102	16.0	46.0	2.80
A6202.9	2.90	0.1142	16.0	46.0	2.90
A6203.0	3.00	0.1181	16.0	46.0	3.00
A6203.1	3.10	0.1220	18.0	49.0	3.10
A6203.2	3.20	0.1260	18.0	49.0	3.20
A6203.3	3.30	0.1299	18.0	49.0	3.30
A6203.4	3.40	0.1339	20.0	52.0	3.40
A6203.5	3.50	0.1378	20.0	52.0	3.50
A6203.6	3.60	0.1417	20.0	52.0	3.60
A6203.7	3.70	0.1457	20.0	52.0	3.70
A6203.8	3.80	0.1496	22.0	55.0	3.80
A6203.9	3.90	0.1535	22.0	55.0	3.90
A6204.0	4.00	0.1575	22.0	55.0	4.00
A6204.1	4.10	0.1614	22.0	55.0	4.10
A6204.2	4.20	0.1654	22.0	55.0	4.20
A6204.3	4.30	0.1693	24.0	58.0	4.30
A6204.4	4.40	0.1732	24.0	58.0	4.40
A6204.5	4.50	0.1772	24.0	58.0	4.50
A6204.6	4.60	0.1811	24.0	58.0	4.60
A6204.7	4.70	0.1850	24.0	58.0	4.70
A6204.8	4.80	0.1890	26.0	62.0	4.80

Producto	DC (mm)	DC (inch)	LCF (mm)	OAL (mm)	DCON MS (mm)
A6204.9	4.90	0.1929	26.0	62.0	4.90
A6205.0	5.00	0.1969	26.0	62.0	5.00
A6205.1	5.10	0.2008	26.0	62.0	5.10
A6205.2	5.20	0.2047	26.0	62.0	5.20
A6205.3	5.30	0.2087	26.0	62.0	5.30
A6205.4	5.40	0.2126	28.0	66.0	5.40
A6205.5	5.50	0.2165	28.0	66.0	5.50
A6205.6	5.60	0.2205	28.0	66.0	5.60
A6205.7	5.70	0.2244	28.0	66.0	5.70
A6205.8	5.80	0.2283	28.0	66.0	5.80
A6205.9	5.90	0.2323	28.0	66.0	5.90
A6206.0	6.00	0.2362	28.0	66.0	6.00
A6206.1	6.10	0.2402	31.0	70.0	6.10
A6206.2	6.20	0.2441	31.0	70.0	6.20
A6206.3	6.30	0.2480	31.0	70.0	6.30
A6206.4	6.40	0.2520	31.0	70.0	6.40
A6206.5	6.50	0.2559	31.0	70.0	6.50
A6206.6	6.60	0.2598	31.0	70.0	6.60
A6206.7	6.70	0.2638	31.0	70.0	6.70
A6206.8	6.80	0.2677	34.0	74.0	6.80
A6206.9	6.90	0.2717	34.0	74.0	6.90
A6207.0	7.00	0.2756	34.0	74.0	7.00
A6207.1	7.10	0.2795	34.0	74.0	7.10
A6207.2	7.20	0.2835	34.0	74.0	7.20



Producto	DC	DC	LCF	OAL	DCON MS
	(mm)	(inch)	(mm)	(mm)	(mm)
A6207.3	7.30	0.2874	34.0	74.0	7.30
A6207.4	7.40	0.2913	34.0	74.0	7.40
A6207.5	7.50	0.2953	34.0	74.0	7.50
A6207.6	7.60	0.2992	37.0	79.0	7.60
A6207.7	7.70	0.3031	37.0	79.0	7.70
A6207.8	7.80	0.3071	37.0	79.0	7.80
A6207.9	7.90	0.3110	37.0	79.0	7.90
A6208.0	8.00	0.3150	37.0	79.0	8.00
A6208.1	8.10	0.3189	37.0	79.0	8.10
A6208.2	8.20	0.3228	37.0	79.0	8.20
A6208.3	8.30	0.3268	37.0	79.0	8.30
A6208.4	8.40	0.3307	37.0	79.0	8.40
A6208.5	8.50	0.3346	37.0	79.0	8.50
A6208.6	8.60	0.3386	40.0	84.0	8.60
A6208.7	8.70	0.3425	40.0	84.0	8.70
A6208.8	8.80	0.3465	40.0	84.0	8.80
A6208.9	8.90	0.3504	40.0	84.0	8.90
A6209.0	9.00	0.3543	40.0	84.0	9.00
A6209.1	9.10	0.3583	40.0	84.0	9.10
A6209.2	9.20	0.3622	40.0	84.0	9.20

Producto	DC	DC	LCF	OAL	DCON MS
	(mm)	(inch)	(mm)	(mm)	(mm)
A6209.3	9.30	0.3661	40.0	84.0	9.30
A6209.4	9.40	0.3701	40.0	84.0	9.40
A6209.5	9.50	0.3740	40.0	84.0	9.50
A6209.6	9.60	0.3780	43.0	89.0	9.60
A6209.7	9.70	0.3819	43.0	89.0	9.70
A6209.8	9.80	0.3858	43.0	89.0	9.80
A6209.9	9.90	0.3898	43.0	89.0	9.90
A62010.0	10.00	0.3937	43.0	89.0	10.00
A62010.2	10.20	0.4016	43.0	89.0	10.20
A62010.3	10.30	0.4055	43.0	89.0	10.30
A62010.4	10.40	0.4094	43.0	89.0	10.40
A62010.5	10.50	0.4134	43.0	89.0	10.50
A62010.8	10.80	0.4252	47.0	95.0	10.80
A62011.0	11.00	0.4331	47.0	95.0	11.00
A62011.5	11.50	0.4528	47.0	95.0	11.50
A62012.0	12.00	0.4724	51.0	102.0	12.00
A62012.2	12.20	0.4803	51.0	102.0	12.20
A62012.5	12.50	0.4921	51.0	102.0	12.50
A62012.8	12.80	0.5039	51.0	102.0	12.80
A62013.0	13.00	0.5118	51.0	102.0	13.00



A117



Broca HSS-E (8% Co), Extra Corta, Bronce Templado (DC ≤ 1,5mm Punta a 118°; DC < 3mm 5% Co)

Broca recomendada para uso en materiales y aplicaciones difíciles. La punta dividida y a 135° facilita el autocentrado y reduce las fuerzas de corte. Fiable para producir un agujero preciso y un acabado de calidad. El acabado bronce consiste en una fina capa de óxido y es indicativo de cobalto.

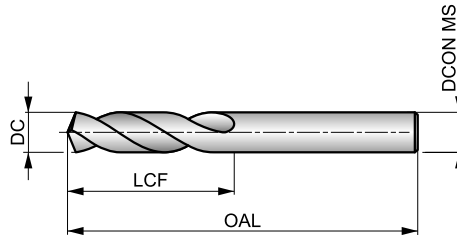

HSS-E	DIN 1897	2.5×D
135°	Bronze	
λ 20-35°	R	DC h8

Grupo de Material de la pieza adecuado y condiciones de velocidad de corte iniciales (m/min) y código de avance alfabético. Tablas con avance por revolución a partir de la pag.175.

P1.1 □40 H	P1.2 □45 H	P1.3 □46 H	P2.1 □34 H	P2.2 □30 G	P2.3 ■27 F	P3.1 □27 G	P3.2 □21 G	P3.3 ■18 F	P4.1 □16 G	P4.2 ■13 F	P4.3 ■11 E	M1.1 ■30 F	M1.2 ■26 F
M2.1 ■27 F	M2.2 ■22 F	M3.1 ■13 H	M3.2 ■11 H	M3.3 ■10 H	M4.1 ■15 D	K1.1 □34 K	K1.2 □25 F	K1.3 □19 F	K2.1 □27 F	K2.2 □22 F	K2.3 ■18 F	K3.1 □24 F	K3.2 □18 F
K3.3 ■15 F	K4.1 □22 F	K4.2 □17 F	K4.3 ■12 F	K4.4 ■11 F	K4.5 ■9 F	K5.1 □25 F	K5.2 □19 F	K5.3 ■15 F	N1.1 □35 K	N1.2 □26 K	N1.3 □18 J	N2.1 □48 I	N2.2 □43 I
N2.3 □31 I	N3.1 □68 J	N3.2 □40 K	N3.3 □20 I	N4.1 □35 M	N4.2 □28 K	N4.3 □17 I	S1.1 ■30 G	S1.2 ■18 F	S1.3 ■10 C	S2.1 ■12 F	S2.2 ■8 C	S3.1 ■9 F	S3.2 ■6 C
S4.1 ■7 F	S4.2 ■5 C												

DC ≤ 1.5mm punta de 118°; DC < 3.00 mm 5% cobalto.

Producto	DC (inch)	DC (mm)	DC (inch)	LCF (mm)	OAL (mm)	DCON MS (mm)
A1171.0	-	1.00	0.0394	6.0	26.0	1.00
A1171.1	-	1.10	0.0433	7.0	28.0	1.10
A1171.2	-	1.20	0.0472	8.0	30.0	1.20
A1171.3	-	1.30	0.0512	8.0	30.0	1.30
A1171.4	-	1.40	0.0551	9.0	32.0	1.40
A1171.5	-	1.50	0.0591	9.0	32.0	1.50
A1171.6	-	1.60	0.0630	10.0	34.0	1.60
A1171.7	-	1.70	0.0669	10.0	34.0	1.70
A1171.8	-	1.80	0.0709	11.0	36.0	1.80
A1171.9	-	1.90	0.0748	11.0	36.0	1.90
A1172.0	-	2.00	0.0787	12.0	38.0	2.00
A1172.1	-	2.10	0.0827	12.0	38.0	2.10
A1172.2	-	2.20	0.0866	13.0	40.0	2.20
A1172.3	-	2.30	0.0906	13.0	40.0	2.30
A1172.4	-	2.40	0.0945	14.0	43.0	2.40
A1172.5	-	2.50	0.0984	14.0	43.0	2.50
A1172.6	-	2.60	0.1024	14.0	43.0	2.60
A1172.7	-	2.70	0.1063	16.0	46.0	2.70
A1172.8	-	2.80	0.1102	16.0	46.0	2.80
A1172.9	-	2.90	0.1142	16.0	46.0	2.90
A1173.0	-	3.00	0.1181	16.0	46.0	3.00
A1173.1	-	3.10	0.1220	18.0	49.0	3.10
A1171/8	1/8	3.18	0.1250	18.0	49.0	3.18

Producto	DC (inch)	DC (mm)	DC (inch)	LCF (mm)	OAL (mm)	DCON MS (mm)
A1173.2	-	3.20	0.1260	18.0	49.0	3.20
A1173.3	-	3.30	0.1299	18.0	49.0	3.30
A1173.4	-	3.40	0.1339	20.0	52.0	3.40
A1173.5	-	3.50	0.1378	20.0	52.0	3.50
A1173.6	-	3.60	0.1417	20.0	52.0	3.60
A1173.7	-	3.70	0.1457	20.0	52.0	3.70
A1173.8	-	3.80	0.1496	22.0	55.0	3.80
A1173.9	-	3.90	0.1535	22.0	55.0	3.90
A1175/32	5/32	3.97	0.1563	22.0	55.0	3.97
A1174.0	-	4.00	0.1575	22.0	55.0	4.00
A1174.1	-	4.10	0.1614	22.0	55.0	4.10
A1174.2	-	4.20	0.1654	22.0	55.0	4.20
A1174.3	-	4.30	0.1693	24.0	58.0	4.30
A1174.4	-	4.40	0.1732	24.0	58.0	4.40
A1174.5	-	4.50	0.1772	24.0	58.0	4.50
A1174.6	-	4.60	0.1811	24.0	58.0	4.60
A1174.7	-	4.70	0.1850	24.0	58.0	4.70
A1173/16	3/16	4.76	0.1875	26.0	62.0	4.76
A1174.8	-	4.80	0.1890	26.0	62.0	4.80
A1174.9	-	4.90	0.1929	26.0	62.0	4.90
A1175.0	-	5.00	0.1969	26.0	62.0	5.00
A1175.1	-	5.10	0.2008	26.0	62.0	5.10
A1175.2	-	5.20	0.2047	26.0	62.0	5.20



Producto	DC	DC	DC	LCF	OAL	DCON MS
	(inch)	(mm)	(inch)	(mm)	(mm)	(mm)
A1175.3	–	5.30	0.2087	26.0	62.0	5.30
A1175.4	–	5.40	0.2126	28.0	66.0	5.40
A1175.5	–	5.50	0.2165	28.0	66.0	5.50
A1175.6	–	5.60	0.2205	28.0	66.0	5.60
A1175.7	–	5.70	0.2244	28.0	66.0	5.70
A1175.8	–	5.80	0.2283	28.0	66.0	5.80
A1175.9	–	5.90	0.2323	28.0	66.0	5.90
A1176.0	–	6.00	0.2362	28.0	66.0	6.00
A1176.1	–	6.10	0.2402	31.0	70.0	6.10
A1176.2	–	6.20	0.2441	31.0	70.0	6.20
A1176.3	–	6.30	0.2480	31.0	70.0	6.30
A1171/4	1/4	6.35	0.2500	31.0	70.0	6.35
A1176.4	–	6.40	0.2520	31.0	70.0	6.40
A1176.5	–	6.50	0.2559	31.0	70.0	6.50
A1176.6	–	6.60	0.2598	31.0	70.0	6.60
A1176.7	–	6.70	0.2638	31.0	70.0	6.70
A1176.8	–	6.80	0.2677	34.0	74.0	6.80
A1176.9	–	6.90	0.2717	34.0	74.0	6.90
A1177.0	–	7.00	0.2756	34.0	74.0	7.00
A1177.1	–	7.10	0.2795	34.0	74.0	7.10
A1177.2	–	7.20	0.2835	34.0	74.0	7.20
A1177.3	–	7.30	0.2874	34.0	74.0	7.30
A1177.4	–	7.40	0.2913	34.0	74.0	7.40
A1177.5	–	7.50	0.2953	34.0	74.0	7.50
A1177.6	–	7.60	0.2992	37.0	79.0	7.60
A1177.7	–	7.70	0.3031	37.0	79.0	7.70
A1177.8	–	7.80	0.3071	37.0	79.0	7.80
A1177.9	–	7.90	0.3110	37.0	79.0	7.90
A1175/16	5/16	7.94	0.3125	37.0	79.0	7.94

Producto	DC	DC	DC	LCF	OAL	DCON MS
	(inch)	(mm)	(inch)	(mm)	(mm)	(mm)
A1178.0	–	8.00	0.3150	37.0	79.0	8.00
A1178.1	–	8.10	0.3189	37.0	79.0	8.10
A1178.2	–	8.20	0.3228	37.0	79.0	8.20
A1178.3	–	8.30	0.3268	37.0	79.0	8.30
A1178.4	–	8.40	0.3307	37.0	79.0	8.40
A1178.5	–	8.50	0.3346	37.0	79.0	8.50
A1178.6	–	8.60	0.3386	40.0	84.0	8.60
A1178.7	–	8.70	0.3425	40.0	84.0	8.70
A1178.8	–	8.80	0.3465	40.0	84.0	8.80
A1178.9	–	8.90	0.3504	40.0	84.0	8.90
A1179.0	–	9.00	0.3543	40.0	84.0	9.00
A1179.1	–	9.10	0.3583	40.0	84.0	9.10
A1179.2	–	9.20	0.3622	40.0	84.0	9.20
A1179.3	–	9.30	0.3661	40.0	84.0	9.30
A1179.4	–	9.40	0.3701	40.0	84.0	9.40
A1179.5	–	9.50	0.3740	40.0	84.0	9.50
A1173/8	3/8	9.52	0.3750	43.0	89.0	9.52
A1179.6	–	9.60	0.3780	43.0	89.0	9.60
A1179.7	–	9.70	0.3819	43.0	89.0	9.70
A1179.8	–	9.80	0.3858	43.0	89.0	9.80
A1179.9	–	9.90	0.3898	43.0	89.0	9.90
A11710.0	–	10.00	0.3937	43.0	89.0	10.00
A11710.2	–	10.20	0.4016	43.0	89.0	10.20
A11710.5	–	10.50	0.4134	43.0	89.0	10.50
A11711.0	–	11.00	0.4331	47.0	95.0	11.00
A11711.5	–	11.50	0.4528	47.0	95.0	11.50
A11712.0	–	12.00	0.4724	51.0	102.0	12.00
A1171/2	1/2	12.70	0.5000	51.0	102.0	12.70
A11713.0	–	13.00	0.5118	51.0	102.0	13.00



A520



Broca ADX HSS, Serie Extra Corta, con Recubrimiento TiN

Broca de alto rendimiento, capaz de producir agujeros precisos y de alta calidad a altas velocidades y avances (tolerancia de agujero H9). La punta adelgazada a 130° mejora el auto-centrado y reduce las fuerzas de corte. Esta broca se debe utilizar únicamente en máquinas con avance constante. El recubrimiento TiN mejora el rendimiento y prolonga la vida de la herramienta.



ADX

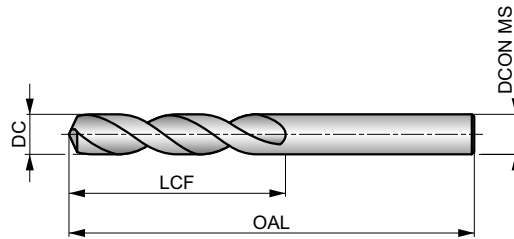

HSS	DIN 1897	2.5×D
130°	TiN	
λ 32-40°	R	DC h8

Grupo de Material de la pieza adecuado y condiciones de velocidad de corte iniciales (m/min) y código de avance alfabético. Tablas con avance por revolución a partir de la pag.175.

P1.1 ■ 53 M	P1.2 ■ 59 M	P1.3 ■ 61 M	P2.1 ■ 45 M	P2.2 ■ 40 K	P2.3 ■ 35 G	P3.1 ■ 31 I	P3.2 ■ 25 I	P3.3 ■ 21 G	P4.1 ■ 19 I	P4.2 ■ 16 G	P4.3 ■ 13 E	M1.1 ■ 41 I	M1.2 ■ 35 I
M2.1 ■ 37 I	M2.2 ■ 30 I	M3.1 ■ 19 I	M3.2 ■ 16 I	M3.3 ■ 14 I	M4.1 ■ 20 G	K1.1 ■ 48 M	K1.2 ■ 36 K	K1.3 ■ 27 K	K2.1 ■ 37 J	K2.2 ■ 30 J	K2.3 ■ 24 F	K3.1 ■ 33 J	K3.2 ■ 25 J
K3.3 ■ 20 F	K4.1 ■ 30 J	K4.2 ■ 23 J	K4.3 ■ 17 F	K4.4 ■ 14 F	K4.5 ■ 12 F	K5.1 ■ 34 J	K5.2 ■ 26 J	K5.3 ■ 20 F	N1.1 ■ 55 I	N1.2 ■ 41 I	N1.3 ■ 28 M	N2.1 ■ 57 K	N2.2 ■ 51 K
N2.3 ■ 37 K	N3.1 ■ 85 K	N3.2 ■ 50 I	N3.3 ■ 25 E	N4.1 ■ 65 G	N4.2 ■ 50 G	N4.3 ■ 35 F	S1.1 ■ 34 I	S1.2 ■ 20 G	S1.3 ■ 4 B	S2.1 ■ 15 G	S2.2 ■ 10 E	S3.1 ■ 11 G	S3.2 ■ 7 E
S4.1 ■ 9 G	S4.2 ■ 6 E												

Producto	DC (inch)	DC (mm)	DC (inch)	LCF (mm)	OAL (mm)	DCON MS (mm)
A5203.0	-	3.00	0.1181	16.0	46.0	3.00
A5203.1	-	3.10	0.1220	18.0	49.0	3.10
A5201/8	1/8	3.18	0.1250	18.0	49.0	3.18
A5203.2	-	3.20	0.1260	18.0	49.0	3.20
A5203.3	-	3.30	0.1299	18.0	49.0	3.30
A5203.4	-	3.40	0.1339	20.0	52.0	3.40
A5203.5	-	3.50	0.1378	20.0	52.0	3.50
A5209/64	9/64	3.57	0.1406	20.0	52.0	3.57
A5203.6	-	3.60	0.1417	20.0	52.0	3.60
A5203.7	-	3.70	0.1457	20.0	52.0	3.70
A5203.8	-	3.80	0.1496	22.0	55.0	3.80
A5203.9	-	3.90	0.1535	22.0	55.0	3.90
A5205/32	5/32	3.97	0.1563	22.0	55.0	3.97
A5204.0	-	4.00	0.1575	22.0	55.0	4.00
A5204.1	-	4.10	0.1614	22.0	55.0	4.10
A5204.2	-	4.20	0.1654	22.0	55.0	4.20
A5204.3	-	4.30	0.1693	24.0	58.0	4.30
A52011/64	11/64	4.37	0.1719	24.0	58.0	4.37
A5204.4	-	4.40	0.1732	24.0	58.0	4.40
A5204.5	-	4.50	0.1772	24.0	58.0	4.50
A5204.6	-	4.60	0.1811	24.0	58.0	4.60
A5204.7	-	4.70	0.1850	24.0	58.0	4.70
A5203/16	3/16	4.76	0.1875	26.0	62.0	4.76
A5204.8	-	4.80	0.1890	26.0	62.0	4.80

Producto	DC (inch)	DC (mm)	DC (inch)	LCF (mm)	OAL (mm)	DCON MS (mm)
A5204.9	-	4.90	0.1929	26.0	62.0	4.90
A5205.0	-	5.00	0.1969	26.0	62.0	5.00
A5205.1	-	5.10	0.2008	26.0	62.0	5.10
A52013/64	13/64	5.16	0.2031	26.0	62.0	5.16
A5205.2	-	5.20	0.2047	26.0	62.0	5.20
A5205.3	-	5.30	0.2087	26.0	62.0	5.30
A5205.4	-	5.40	0.2126	28.0	66.0	5.40
A5205.5	-	5.50	0.2165	28.0	66.0	5.50
A5207/32	7/32	5.56	0.2188	28.0	66.0	5.56
A5205.6	-	5.60	0.2205	28.0	66.0	5.60
A5205.7	-	5.70	0.2244	28.0	66.0	5.70
A5205.8	-	5.80	0.2283	28.0	66.0	5.80
A5205.9	-	5.90	0.2323	28.0	66.0	5.90
A52015/64	15/64	5.95	0.2344	28.0	66.0	5.95
A5206.0	-	6.00	0.2362	28.0	66.0	6.00
A5206.1	-	6.10	0.2402	31.0	70.0	6.10
A5206.2	-	6.20	0.2441	31.0	70.0	6.20
A5206.3	-	6.30	0.2480	31.0	70.0	6.30
A5201/4	1/4	6.35	0.2500	31.0	70.0	6.35
A5206.4	-	6.40	0.2520	31.0	70.0	6.40
A5206.5	-	6.50	0.2559	31.0	70.0	6.50
A5206.6	-	6.60	0.2598	31.0	70.0	6.60
A5206.7	-	6.70	0.2638	31.0	70.0	6.70
A52017/64	17/64	6.75	0.2656	34.0	74.0	6.75



Producto	DC	DC	DC	LCF	OAL	DCON MS
	(inch)	(mm)	(inch)	(mm)	(mm)	(mm)
A5206.8	–	6.80	0.2677	34.0	74.0	6.80
A5206.9	–	6.90	0.2717	34.0	74.0	6.90
A5207.0	–	7.00	0.2756	34.0	74.0	7.00
A5207.1	–	7.10	0.2795	34.0	74.0	7.10
A5209/32	9/32	7.14	0.2813	34.0	74.0	7.14
A5207.2	–	7.20	0.2835	34.0	74.0	7.20
A5207.3	–	7.30	0.2874	34.0	74.0	7.30
A5207.4	–	7.40	0.2913	34.0	74.0	7.40
A5207.5	–	7.50	0.2953	34.0	74.0	7.50
A52019/64	19/64	7.54	0.2969	37.0	79.0	7.54
A5207.6	–	7.60	0.2992	37.0	79.0	7.60
A5207.7	–	7.70	0.3031	37.0	79.0	7.70
A5207.8	–	7.80	0.3071	37.0	79.0	7.80
A5207.9	–	7.90	0.3110	37.0	79.0	7.90
A5205/16	5/16	7.94	0.3125	37.0	79.0	7.94
A5208.0	–	8.00	0.3150	37.0	79.0	8.00
A5208.1	–	8.10	0.3189	37.0	79.0	8.10
A5208.2	–	8.20	0.3228	37.0	79.0	8.20
A5208.3	–	8.30	0.3268	37.0	79.0	8.30
A52021/64	21/64	8.33	0.3281	37.0	79.0	8.33
A5208.4	–	8.40	0.3307	37.0	79.0	8.40
A5208.5	–	8.50	0.3346	37.0	79.0	8.50
A5208.6	–	8.60	0.3386	40.0	84.0	8.60
A5208.7	–	8.70	0.3425	40.0	84.0	8.70
A52011/32	11/32	8.73	0.3438	40.0	84.0	8.73
A5208.8	–	8.80	0.3465	40.0	84.0	8.80
A5208.9	–	8.90	0.3504	40.0	84.0	8.90
A5209.0	–	9.00	0.3543	40.0	84.0	9.00
A5209.1	–	9.10	0.3583	40.0	84.0	9.10
A52023/64	23/64	9.13	0.3594	40.0	84.0	9.13
A5209.2	–	9.20	0.3622	40.0	84.0	9.20
A5209.3	–	9.30	0.3661	40.0	84.0	9.30
A5209.4	–	9.40	0.3701	40.0	84.0	9.40
A5209.5	–	9.50	0.3740	40.0	84.0	9.50
A5203/8	3/8	9.52	0.3750	43.0	89.0	9.52
A5209.6	–	9.60	0.3780	43.0	89.0	9.60
A5209.7	–	9.70	0.3819	43.0	89.0	9.70
A5209.8	–	9.80	0.3858	43.0	89.0	9.80
A5209.9	–	9.90	0.3898	43.0	89.0	9.90

Producto	DC	DC	DC	LCF	OAL	DCON MS
	(inch)	(mm)	(inch)	(mm)	(mm)	(mm)
A52025/64	25/64	9.92	0.3906	43.0	89.0	9.92
A52010.0	–	10.00	0.3937	43.0	89.0	10.00
A52010.1	–	10.10	0.3976	43.0	89.0	10.10
A52010.2	–	10.20	0.4016	43.0	89.0	10.20
A52010.3	–	10.30	0.4055	43.0	89.0	10.30
A52013/32	13/32	10.32	0.4063	43.0	89.0	10.32
A52010.4	–	10.40	0.4094	43.0	89.0	10.40
A52010.5	–	10.50	0.4134	43.0	89.0	10.50
A52010.6	–	10.60	0.4173	43.0	89.0	10.60
A52010.7	–	10.70	0.4213	47.0	95.0	10.70
A52027/64	27/64	10.72	0.4219	47.0	95.0	10.72
A52010.8	–	10.80	0.4252	47.0	95.0	10.80
A52010.9	–	10.90	0.4291	47.0	95.0	10.90
A52011.0	–	11.00	0.4331	47.0	95.0	11.00
A52011.1	–	11.10	0.4370	47.0	95.0	11.10
A5207/16	7/16	11.11	0.4375	47.0	95.0	11.11
A52011.2	–	11.20	0.4409	47.0	95.0	11.20
A52011.3	–	11.30	0.4449	47.0	95.0	11.30
A52011.4	–	11.40	0.4488	47.0	95.0	11.40
A52011.5	–	11.50	0.4528	47.0	95.0	11.50
A52029/64	29/64	11.51	0.4531	47.0	95.0	11.51
A52011.6	–	11.60	0.4567	47.0	95.0	11.60
A52011.7	–	11.70	0.4606	47.0	95.0	11.70
A52011.8	–	11.80	0.4646	47.0	95.0	11.80
A52011.9	–	11.90	0.4685	51.0	102.0	11.90
A52015/32	15/32	11.91	0.4688	51.0	102.0	11.91
A52012.0	–	12.00	0.4724	51.0	102.0	12.00
A52012.1	–	12.10	0.4764	51.0	102.0	12.10
A52012.2	–	12.20	0.4803	51.0	102.0	12.20
A52012.3	–	12.30	0.4843	51.0	102.0	12.30
A52031/64	31/64	12.30	0.4844	51.0	102.0	12.30
A52012.4	–	12.40	0.4882	51.0	102.0	12.40
A52012.5	–	12.50	0.4921	51.0	102.0	12.50
A52012.6	–	12.60	0.4961	51.0	102.0	12.60
A52012.7	–	12.70	0.5000	51.0	102.0	12.70
A5201/2	1/2	12.70	0.5000	51.0	102.0	12.70
A52012.8	–	12.80	0.5039	51.0	102.0	12.80
A52012.9	–	12.90	0.5079	51.0	102.0	12.90
A52013.0	–	13.00	0.5118	51.0	102.0	13.00



A124



Broca HSS serie Extra Corta, con Punta Soldada de Metal Duro, Acabado Templado al Vapor

Punta de metal duro soldada que proporciona el alto rendimiento de una broca de metal duro a una broca con cuerpo de HSS resistente y menos quebradizo. La punta de 118° y 4 facetas mejora el autocentrado, lo que la convierte en una opción económica. Se puede utilizar tanto en máquinas convencionales como CNC. El acabado templado al vapor retiene el fluido de corte.

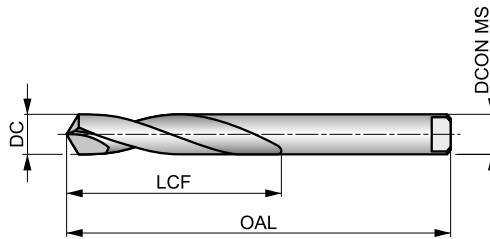

HSS HM	DIN 8037	2.5×D
118°	Bright ST	
λ 10-20°	R	

Grupo de Material de la pieza adecuado y condiciones de velocidad de corte iniciales (m/min) y código de avance alfabético. Tablas con avance por revolución a partir de la pag.175.

P2.3 ■ 40 C	P3.3 ■ 40 C	P4.2 ■ 30 C	P4.3 ■ 24 A	M3.1 ■ 41 C	M3.2 ■ 35 C	M3.3 ■ 32 C	M4.1 ■ 35 C	K1.1 ■ 55 C	K1.2 ■ 41 C	K1.3 ■ 31 C	K2.1 ■ 49 C	K2.2 ■ 40 C	K2.3 ■ 32 A
K3.1 ■ 44 C	K3.2 ■ 33 C	K3.3 ■ 27 A	K4.1 ■ 40 C	K4.2 ■ 30 C	K4.3 ■ 22 A	K4.4 ■ 19 A	K4.5 ■ 16 A	K5.1 ■ 46 C	K5.2 ■ 34 C	K5.3 ■ 27 A	N3.1 ■ 119 E	N3.2 ■ 170 G	N4.2 ■ 60 E
S1.1 ■ 40 A	S1.2 ■ 35 A	S1.3 ■ 25 A	S2.1 ■ 33 A	S2.2 ■ 28 A	S3.1 ■ 25 A	S3.2 ■ 20 A	S4.1 ■ 20 A	S4.2 ■ 16 A					

Lengüeta según DIN 1809.

Producto	DC (mm)	DC (inch)	LCF (mm)	OAL (mm)	DCON MS (mm)
A1243.0	3.00	0.1181	20.0	50.0	3.00
A1243.2	3.20	0.1260	25.0	56.0	3.20
A1243.5	3.50	0.1378	25.0	56.0	3.50
A1244.0	4.00	0.1575	25.0	56.0	4.00
A1244.2	4.20	0.1654	28.0	63.0	4.20
A1244.5	4.50	0.1772	28.0	63.0	4.50
A1244.8	4.80	0.1890	28.0	63.0	4.80
A1245.0	5.00	0.1969	28.0	63.0	5.00
A1245.2	5.20	0.2047	32.0	71.0	5.20
A1245.5	5.50	0.2165	32.0	71.0	5.50
A1245.8	5.80	0.2283	32.0	71.0	5.80
A1246.0	6.00	0.2362	32.0	71.0	6.00
A1246.5	6.50	0.2559	32.0	71.0	6.50
A1246.8	6.80	0.2677	40.0	80.0	6.80
A1247.0	7.00	0.2756	40.0	80.0	7.00

Producto	DC (mm)	DC (inch)	LCF (mm)	OAL (mm)	DCON MS (mm)
A1247.5	7.50	0.2953	40.0	80.0	7.50
A1248.0	8.00	0.3150	40.0	80.0	8.00
A1248.5	8.50	0.3346	50.0	90.0	8.50
A1249.0	9.00	0.3543	50.0	90.0	9.00
A1249.5	9.50	0.3740	50.0	90.0	9.50
A12410.0	10.00	0.3937	56.0	100.0	10.00
A12410.5	10.50	0.4134	56.0	100.0	10.50
A12411.0	11.00	0.4331	56.0	100.0	11.00
A12411.5	11.50	0.4528	63.0	112.0	11.50
A12412.0	12.00	0.4724	63.0	112.0	12.00
A12413.0	13.00	0.5118	63.0	112.0	13.00
A12414.0	14.00	0.5512	71.0	125.0	14.00
A12415.0	15.00	0.5906	71.0	125.0	15.00
A12416.0	16.00	0.6299	80.0	140.0	16.00



A720



Micro Broca HSS-E (5% Cobalto), Acabado Brillante

Micro broca en diámetros muy pequeños que van desde 0,15 mm hasta 1,40 mm. Para facilitar la sujeción de la herramienta, todas las brocas tienen un diámetro de mango de 1,00 mm o 1,50 mm. Todas las brocas tienen punta a 118° y 4 facetas, que favorece el autocentrado y reduce las fuerzas de corte.

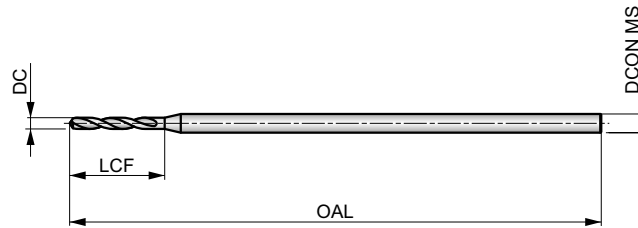

HSS-E	DIN 1899	2.5×D
118°	Bright	
20-35°	R	

Grupo de Material de la pieza adecuado y condiciones de velocidad de corte iniciales (m/min) y código de avance alfabético. Tablas con avance por revolución a partir de la pag.175.

P1.1 ■ 36 A	P1.2 ■ 40 A	P1.3 ■ 41 A	P2.1 ■ 31 A	P2.2 ■ 27 A	P2.3 ■ 24 A	P3.1 ■ 25 A	P3.2 ■ 20 A	P3.3 ■ 17 A	P4.1 ■ 15 A	P4.2 ■ 13 A	P4.3 ■ 10 A	M1.1 ■ 30 A	M1.2 ■ 26 A
M2.1 ■ 27 A	M2.2 ■ 22 A	M3.1 ■ 12 A	M3.2 ■ 10 A	M3.3 ■ 9 A	M4.1 ■ 15 A	K1.1 ■ 30 A	K1.2 ■ 22 A	K1.3 ■ 17 A	K2.1 ■ 25 A	K2.2 ■ 20 A	K2.3 ■ 16 A	K3.1 ■ 22 A	K3.2 ■ 17 A
K3.3 ■ 13 A	K4.1 ■ 20 A	K4.2 ■ 15 A	K4.3 ■ 11 A	K4.4 ■ 10 A	K4.5 ■ 8 A	K5.1 ■ 23 A	K5.2 ■ 17 A	K5.3 ■ 13 A	N1.1 ■ 35 A	N1.2 ■ 26 A	N1.3 ■ 18 A	N2.1 ■ 42 A	N2.2 ■ 37 A
N2.3 ■ 27 A	N3.1 ■ 68 A	N3.2 ■ 40 A	N3.3 ■ 20 A	N4.1 ■ 48 A	N4.2 ■ 25 A	S1.1 ■ 23 A	S1.2 ■ 17 A	S1.3 ■ 8 A	S2.1 ■ 9 A	S2.2 ■ 6 A	S3.1 ■ 7 A	S3.2 ■ 4 A	S4.1 ■ 5 A
S4.2 ■ 3 A													

Producto	DC (mm)	DC (inch)	LCF (mm)	OAL (mm)	DCON MS (mm)
A720.15	0.15	0.0059	1.0	25.0	1.00
A720.16	0.16	0.0063	1.4	25.0	1.00
A720.17	0.17	0.0067	1.4	25.0	1.00
A720.18	0.18	0.0070	1.4	25.0	1.00
A720.2	0.20	0.0079	1.8	25.0	1.00
A720.22	0.22	0.0087	1.8	25.0	1.00
A720.25	0.25	0.0098	2.2	25.0	1.00
A720.27	0.27	0.0106	2.2	25.0	1.00
A720.28	0.28	0.0110	2.2	25.0	1.00
A720.3	0.30	0.0118	2.2	25.0	1.00
A720.35	0.35	0.0138	2.8	25.0	1.00
A720.38	0.38	0.0150	2.8	25.0	1.00
A720.39	0.39	0.0154	3.6	25.0	1.00
A720.4	0.40	0.0157	3.6	25.0	1.00
A720.45	0.45	0.0177	3.6	25.0	1.00
A720.5	0.50	0.0197	4.0	25.0	1.00

Producto	DC (mm)	DC (inch)	LCF (mm)	OAL (mm)	DCON MS (mm)
A720.55	0.55	0.0217	4.5	25.0	1.00
A720.6	0.60	0.0236	4.5	25.0	1.00
A720.62	0.62	0.0244	5.0	25.0	1.00
A720.65	0.65	0.0256	5.0	25.0	1.00
A720.7	0.70	0.0276	5.6	25.0	1.00
A720.75	0.75	0.0295	5.6	25.0	1.00
A720.8	0.80	0.0315	6.3	25.0	1.50
A720.85	0.85	0.0335	6.3	25.0	1.50
A720.9	0.90	0.0354	7.1	25.0	1.50
A720.95	0.95	0.0374	7.1	25.0	1.50
A7201.0	1.00	0.0394	8.0	25.0	1.50
A7201.05	1.05	0.0413	8.0	25.0	1.50
A7201.1	1.10	0.0433	9.0	25.0	1.50
A7201.2	1.20	0.0472	10.0	25.0	1.50
A7201.3	1.30	0.0512	10.0	25.0	1.50
A7201.4	1.40	0.0551	11.2	25.0	1.50



A920



Broca PFX HSS-E (5% Cobalto), Serie Extra Corta, Acabado Brillante

Broca de alto rendimiento, capaz de producir agujeros precisos y de alta calidad a altas velocidades y avances (tolerancia de agujero H10). La punta autocentrante a 130° y el diseño especial parabólico de los canales ayudan a taladrar agujeros profundos en una sola pasada. Apta para la mayoría de materiales.



PFX

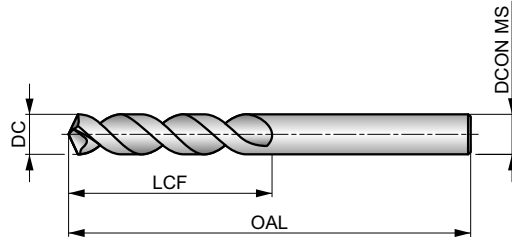

HSS-E	DIN ANSI	3xD
130°	Bright	
λ > 35°	R	DC h8

Grupo de Material de la pieza adecuado y condiciones de velocidad de corte iniciales (m/min) y código de avance alfabético. Tablas con avance por revolución a partir de la pag.175.

P1.1 ■ 42 J	P1.2 ■ 47 J	P1.3 ■ 49 J	P2.1 ■ 36 J	P2.2 ■ 32 I	P2.3 ■ 28 E	P3.1 ■ 34 I	P3.2 ■ 27 I	P3.3 ■ 23 E	P4.1 ■ 20 I	P4.2 ■ 17 E	P4.3 ■ 14 E	M1.1 ■ 21 F	M1.2 ■ 17 F
M2.1 ■ 18 F	M2.2 ■ 15 F	M3.1 ■ 8 F	M3.2 ■ 7 F	M3.3 ■ 6 F	M4.1 ■ 9 D	K1.1 ■ 34 L	K1.2 ■ 25 L	K1.3 ■ 19 L	K2.1 ■ 32 L	K2.2 ■ 26 L	K2.3 ■ 21 J	K3.1 ■ 28 L	K3.2 ■ 22 L
K3.3 ■ 17 J	K4.1 ■ 26 L	K4.2 ■ 20 L	K4.3 ■ 14 J	K4.4 ■ 12 J	K4.5 ■ 10 J	K5.1 ■ 30 L	K5.2 ■ 22 L	K5.3 ■ 17 J	N1.1 ■ 75 L	N1.2 ■ 56 L	N1.3 ■ 38 N	N2.1 ■ 62 N	N2.2 ■ 55 N
N2.3 ■ 40 N	N3.1 ■ 112 J	N3.2 ■ 66 J	N3.3 ■ 33 H	N4.1 ■ 55 J	N4.2 ■ 40 H	S1.1 ■ 30 G	S1.2 ■ 18 G	S1.3 ■ 10 C	S2.1 ■ 12 G	S2.2 ■ 8 E	S3.1 ■ 9 G	S3.2 ■ 6 E	S4.1 ■ 7 G
S4.2 ■ 5 E													

Producto	DC (inch)	DC (mm)	DC (inch)	LCF (mm)	OAL (mm)	DCON MS (mm)
A9201.0	-	1.00	0.0394	6.0	26.0	1.00
A9201.1	-	1.10	0.0433	7.0	28.0	1.10
A9203/64	3/64	1.19	0.0469	13.0	35.0	1.19
A9201.2	-	1.20	0.0472	8.0	30.0	1.20
A9201.25	-	1.25	0.0492	8.0	30.0	1.25
A9201.3	-	1.30	0.0512	8.0	30.0	1.30
A9201.35	-	1.35	0.0531	9.0	32.0	1.35
A9201.4	-	1.40	0.0551	9.0	32.0	1.40
A9201.5	-	1.50	0.0591	9.0	32.0	1.50
A9201.55	-	1.55	0.0610	10.0	34.0	1.55
A9201/16	1/16	1.59	0.0625	16.0	41.0	1.59
A9201.6	-	1.60	0.0630	10.0	34.0	1.60
A9201.7	-	1.70	0.0669	10.0	34.0	1.70
A9201.75	-	1.75	0.0689	11.0	36.0	1.75
A9201.8	-	1.80	0.0709	11.0	36.0	1.80
A9201.9	-	1.90	0.0748	11.0	36.0	1.90
A9205/64	5/64	1.98	0.0781	17.0	43.0	1.98
A9202.0	-	2.00	0.0787	12.0	38.0	2.00
A9202.1	-	2.10	0.0827	12.0	38.0	2.10
A9202.15	-	2.15	0.0846	13.0	40.0	2.15
A9202.2	-	2.20	0.0866	13.0	40.0	2.20
A9202.3	-	2.30	0.0906	13.0	40.0	2.30
A9202.35	-	2.35	0.0925	14.0	43.0	2.35
A9203/32	3/32	2.38	0.0938	19.0	41.0	2.38

Producto	DC (inch)	DC (mm)	DC (inch)	LCF (mm)	OAL (mm)	DCON MS (mm)
A9202.4	-	2.40	0.0945	14.0	43.0	2.40
A9202.5	-	2.50	0.0984	14.0	43.0	2.50
A9202.6	-	2.60	0.1024	14.0	43.0	2.60
A9202.7	-	2.70	0.1063	16.0	46.0	2.70
A9207/64	7/64	2.78	0.1094	21.0	46.0	2.78
A9202.8	-	2.80	0.1102	16.0	46.0	2.80
A9202.9	-	2.90	0.1142	16.0	46.0	2.90
A9203.0	-	3.00	0.1181	16.0	46.0	3.00
A9203.1	-	3.10	0.1220	18.0	49.0	3.10
A9201/8	1/8	3.18	0.1250	22.0	48.0	3.18
A9203.2	-	3.20	0.1260	18.0	49.0	3.20
A9203.3	-	3.30	0.1299	18.0	49.0	3.30
A9203.4	-	3.40	0.1339	20.0	52.0	3.40
A9203.5	-	3.50	0.1378	20.0	52.0	3.50
A9209/64	9/64	3.57	0.1406	24.0	49.0	3.57
A9203.6	-	3.60	0.1417	20.0	52.0	3.60
A9203.7	-	3.70	0.1457	20.0	52.0	3.70
A9203.8	-	3.80	0.1496	22.0	55.0	3.80
A9203.9	-	3.90	0.1535	22.0	55.0	3.90
A9205/32	5/32	3.97	0.1563	25.0	52.0	3.97
A9204.0	-	4.00	0.1575	22.0	55.0	4.00
A9204.1	-	4.10	0.1614	22.0	55.0	4.10
A9204.2	-	4.20	0.1654	22.0	55.0	4.20
A9204.3	-	4.30	0.1693	24.0	58.0	4.30



Producto	DC	DC	DC	LCF	OAL	D CON MS
	(inch)	(mm)	(inch)	(mm)	(mm)	(mm)
A92011/64	11/64	4.37	0.1719	27.0	54.0	4.37
A9204.4	–	4.40	0.1732	24.0	58.0	4.40
A9204.5	–	4.50	0.1772	24.0	58.0	4.50
A9204.6	–	4.60	0.1811	24.0	58.0	4.60
A9204.7	–	4.70	0.1850	24.0	58.0	4.70
A9203/16	3/16	4.76	0.1875	29.0	56.0	4.76
A9204.8	–	4.80	0.1890	26.0	62.0	4.80
A9204.9	–	4.90	0.1929	26.0	62.0	4.90
A9205.0	–	5.00	0.1969	26.0	62.0	5.00
A9205.1	–	5.10	0.2008	26.0	62.0	5.10
A92013/64	13/64	5.16	0.2031	30.0	57.0	5.16
A9205.2	–	5.20	0.2047	26.0	62.0	5.20
A9205.3	–	5.30	0.2087	26.0	62.0	5.30
A9205.4	–	5.40	0.2126	28.0	66.0	5.40
A9205.5	–	5.50	0.2165	28.0	66.0	5.50
A9207/32	7/32	5.56	0.2188	32.0	60.0	5.56
A9205.6	–	5.60	0.2205	28.0	66.0	5.60
A9205.7	–	5.70	0.2244	28.0	66.0	5.70
A9205.8	–	5.80	0.2283	28.0	66.0	5.80
A9205.9	–	5.90	0.2323	28.0	66.0	5.90
A92015/64	15/64	5.95	0.2344	33.0	62.0	5.95
A9206.0	–	6.00	0.2362	28.0	66.0	6.00
A9206.1	–	6.10	0.2402	31.0	70.0	6.10
A9206.2	–	6.20	0.2441	31.0	70.0	6.20
A9206.3	–	6.30	0.2480	31.0	70.0	6.30
A9201/4	1/4	6.35	0.2500	35.0	64.0	6.35
A9206.4	–	6.40	0.2520	31.0	70.0	6.40
A9206.5	–	6.50	0.2559	31.0	70.0	6.50
A9206.6	–	6.60	0.2598	31.0	70.0	6.60
A9206.7	–	6.70	0.2638	31.0	70.0	6.70
A92017/64	17/64	6.75	0.2656	37.0	67.0	6.75
A9206.8	–	6.80	0.2677	34.0	74.0	6.80
A9206.9	–	6.90	0.2717	34.0	74.0	6.90
A9207.0	–	7.00	0.2756	34.0	74.0	7.00
A9207.1	–	7.10	0.2795	34.0	74.0	7.10
A9209/32	9/32	7.14	0.2813	38.0	68.0	7.14
A9207.2	–	7.20	0.2835	34.0	74.0	7.20
A9207.3	–	7.30	0.2874	34.0	74.0	7.30
A9207.4	–	7.40	0.2913	34.0	74.0	7.40
A9207.5	–	7.50	0.2953	34.0	74.0	7.50
A92019/64	19/64	7.54	0.2969	40.0	70.0	7.54
A9207.6	–	7.60	0.2992	37.0	79.0	7.60
A9207.7	–	7.70	0.3031	37.0	79.0	7.70
A9207.8	–	7.80	0.3071	37.0	79.0	7.80
A9207.9	–	7.90	0.3110	37.0	79.0	7.90
A9205/16	5/16	7.94	0.3125	41.0	71.0	7.94
A9208.0	–	8.00	0.3150	37.0	79.0	8.00
A9208.1	–	8.10	0.3189	37.0	79.0	8.10
A9208.2	–	8.20	0.3228	37.0	79.0	8.20
A9208.3	–	8.30	0.3268	37.0	79.0	8.30
A92021/64	21/64	8.33	0.3281	43.0	75.0	8.33
A9208.4	–	8.40	0.3307	37.0	79.0	8.40
A9208.5	–	8.50	0.3346	37.0	79.0	8.50
A9208.6	–	8.60	0.3386	40.0	84.0	8.60
A9208.7	–	8.70	0.3425	40.0	84.0	8.70
A92011/32	11/32	8.73	0.3438	43.0	76.0	8.73
A9208.8	–	8.80	0.3465	40.0	84.0	8.80
A9208.9	–	8.90	0.3504	40.0	84.0	8.90
A9209.0	–	9.00	0.3543	40.0	84.0	9.00
A9209.1	–	9.10	0.3583	40.0	84.0	9.10
A92023/64	23/64	9.13	0.3594	44.0	78.0	9.13
A9209.2	–	9.20	0.3622	40.0	84.0	9.20

Producto	DC	DC	DC	LCF	OAL	D CON MS
	(inch)	(mm)	(inch)	(mm)	(mm)	(mm)
A9209.3	–	9.30	0.3661	40.0	84.0	9.30
A9209.4	–	9.40	0.3701	40.0	84.0	9.40
A9209.5	–	9.50	0.3740	40.0	84.0	9.50
A9203/8	3/8	9.52	0.3750	46.0	79.0	9.52
A9209.6	–	9.60	0.3780	43.0	89.0	9.60
A9209.7	–	9.70	0.3819	43.0	89.0	9.70
A9209.8	–	9.80	0.3858	43.0	89.0	9.80
A9209.9	–	9.90	0.3898	43.0	89.0	9.90
A92025/64	25/64	9.92	0.3906	48.0	83.0	9.92
A92010.0	–	10.00	0.3937	43.0	89.0	10.00
A92010.2	–	10.20	0.4016	43.0	89.0	10.20
A92010.3	–	10.30	0.4055	43.0	89.0	10.30
A92013/32	13/32	10.32	0.4063	49.0	84.0	10.32
A92010.5	–	10.50	0.4134	43.0	89.0	10.50
A92027/64	27/64	10.72	0.4219	51.0	86.0	10.72
A92010.8	–	10.80	0.4252	47.0	95.0	10.80
A92011.0	–	11.00	0.4331	47.0	95.0	11.00
A9207/16	7/16	11.11	0.4375	52.0	87.0	11.11
A92011.5	–	11.50	0.4528	47.0	95.0	11.50
A92029/64	29/64	11.51	0.4531	54.0	90.0	11.51
A92011.8	–	11.80	0.4646	47.0	95.0	11.80
A92015/32	15/32	11.91	0.4688	54.0	92.0	11.91
A92012.0	–	12.00	0.4724	51.0	102.0	12.00
A92012.2	–	12.20	0.4803	51.0	102.0	12.20
A92031/64	31/64	12.30	0.4844	56.0	94.0	12.30
A92012.5	–	12.50	0.4921	51.0	102.0	12.50
A9201/2	1/2	12.70	0.5000	57.0	95.0	12.70
A92013.0	–	13.00	0.5118	51.0	102.0	13.00
A92033/64	33/64	13.10	0.5156	60.0	98.0	13.10
A92013.5	–	13.50	0.5315	54.0	107.0	13.50
A92035/64	35/64	13.89	0.5469	64.0	102.0	13.89
A92014.0	–	14.00	0.5512	54.0	107.0	14.00
A9209/16	9/16	14.29	0.5625	64.0	102.0	14.29
A92014.5	–	14.50	0.5709	56.0	111.0	14.50
A92037/64	37/64	14.68	0.5781	67.0	105.0	14.68
A92014.75	–	14.75	0.5807	56.0	111.0	14.75
A92015.0	–	15.00	0.5906	56.0	111.0	15.00
A92019/32	19/32	15.08	0.5938	67.0	105.0	15.08
A92039/64	39/64	15.48	0.6094	70.0	108.0	15.48
A92015.5	–	15.50	0.6102	58.0	115.0	15.50
A9205/8	5/8	15.88	0.6250	70.0	108.0	15.88
A92016.0	–	16.00	0.6299	58.0	115.0	16.00
A92041/64	41/64	16.27	0.6406	73.0	114.0	16.27
A92016.5	–	16.50	0.6496	60.0	119.0	16.50
A92021/32	21/32	16.67	0.6563	73.0	114.0	16.67
A92016.75	–	16.75	0.6594	60.0	119.0	16.75
A92017.0	–	17.00	0.6693	60.0	119.0	17.00
A92043/64	43/64	17.07	0.6719	73.0	117.0	17.07
A92011/16	11/16	17.46	0.6875	73.0	117.0	17.46
A92017.5	–	17.50	0.6890	62.0	123.0	17.50
A92045/64	45/64	17.86	0.7031	76.0	121.0	17.86
A92018.0	–	18.00	0.7087	62.0	123.0	18.00
A92023/32	23/32	18.26	0.7188	76.0	121.0	18.26
A92018.5	–	18.50	0.7283	64.0	127.0	18.50
A92047/64	47/64	18.65	0.7344	79.0	127.0	18.65
A92019.0	–	19.00	0.7480	64.0	127.0	19.00
A9203/4	3/4	19.05	0.7500	79.0	127.0	19.05
A92049/64	49/64	19.45	0.7656	83.0	130.0	19.45
A92019.5	–	19.50	0.7677	66.0	131.0	19.50
A92025/32	25/32	19.84	0.7813	83.0	130.0	19.84
A92020.0	–	20.00	0.7874	66.0	131.0	20.00



A921



Broca PFX HSS-E (5% Cobalto), Serie Extra Corta, con Recubrimiento Alcrona Top

Broca de alto rendimiento, capaz de producir agujeros precisos y de alta calidad a altas velocidades y avances (tolerancia de agujero H10). Punta autocentrante a 130° y diseño especial parabólico de los canales. Apta para la mayoría de materiales. El recubrimiento Alcrona-TOP mejora el rendimiento y prolonga la vida de la herramienta.



PFX

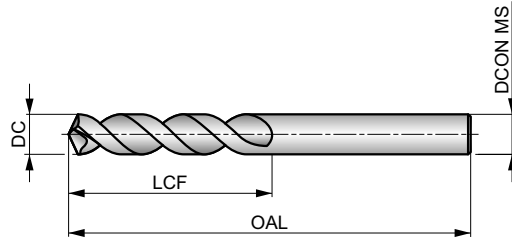

HSS-E	DIN ANSI	3xD
130°	Alcrona Top	
λ > 35°	R	DC h8

Grupo de Material de la pieza adecuado y condiciones de velocidad de corte iniciales (m/min) y código de avance alfabético. Tablas con avance por revolución a partir de la pag.175.

P1.1 ■ 70 M	P1.2 ■ 79 M	P1.3 ■ 81 M	P2.1 ■ 60 M	P2.2 ■ 53 J	P2.3 ■ 47 G	P3.1 ■ 56 J	P3.2 ■ 45 J	P3.3 ■ 38 G	P4.1 ■ 33 J	P4.2 ■ 28 G	P4.3 ■ 23 G	M1.1 ■ 23 F	M1.2 ■ 20 F
M2.1 ■ 21 F	M2.2 ■ 17 F	M3.1 ■ 10 F	M3.2 ■ 9 F	M3.3 ■ 8 F	M4.1 ■ 11 D	K1.1 ■ 53 L	K1.2 ■ 39 L	K1.3 ■ 29 L	K2.1 ■ 52 L	K2.2 ■ 42 L	K2.3 ■ 33 J	K3.1 ■ 46 L	K3.2 ■ 35 L
K3.3 ■ 28 J	K4.1 ■ 42 L	K4.2 ■ 32 L	K4.3 ■ 23 J	K4.4 ■ 20 J	K4.5 ■ 17 J	K5.1 ■ 48 L	K5.2 ■ 36 L	K5.3 ■ 28 J	S1.1 ■ 48 I	S1.2 ■ 29 I	S1.3 ■ 16 E	S2.1 ■ 19 I	S2.2 ■ 14 G
S3.1 ■ 14 I	S3.2 ■ 10 G	S4.1 ■ 11 I	S4.2 ■ 8 G										

Producto	DC (inch)	DC (mm)	DC (inch)	LCF (mm)	OAL (mm)	DCON MS (mm)
A9212.5	-	2.50	0.0984	14.0	43.0	2.50
A9212.6	-	2.60	0.1024	14.0	43.0	2.60
A9212.7	-	2.70	0.1063	16.0	46.0	2.70
A9217/64	7/64	2.78	0.1094	21.0	46.0	2.78
A9212.9	-	2.90	0.1142	16.0	46.0	2.90
A9213.0	-	3.00	0.1181	16.0	46.0	3.00
A9213.1	-	3.10	0.1220	18.0	49.0	3.10
A9211/8	1/8	3.18	0.1250	22.0	48.0	3.18
A9213.2	-	3.20	0.1260	18.0	49.0	3.20
A9213.3	-	3.30	0.1299	18.0	49.0	3.30
A9213.4	-	3.40	0.1339	20.0	52.0	3.40
A9213.5	-	3.50	0.1378	20.0	52.0	3.50
A9219/64	9/64	3.57	0.1406	24.0	49.0	3.57
A9213.6	-	3.60	0.1417	20.0	52.0	3.60
A9213.7	-	3.70	0.1457	20.0	52.0	3.70
A9213.8	-	3.80	0.1496	22.0	55.0	3.80
A9213.9	-	3.90	0.1535	22.0	55.0	3.90
A9215/32	5/32	3.97	0.1563	25.0	52.0	3.97
A9214.0	-	4.00	0.1575	22.0	55.0	4.00
A9214.1	-	4.10	0.1614	22.0	55.0	4.10
A9214.2	-	4.20	0.1654	22.0	55.0	4.20
A9214.3	-	4.30	0.1693	24.0	58.0	4.30
A92111/64	11/64	4.37	0.1719	27.0	54.0	4.37
A9214.4	-	4.40	0.1732	24.0	58.0	4.40
A9214.5	-	4.50	0.1772	24.0	58.0	4.50
A9214.6	-	4.60	0.1811	24.0	58.0	4.60

Producto	DC (inch)	DC (mm)	DC (inch)	LCF (mm)	OAL (mm)	DCON MS (mm)
A9214.7	-	4.70	0.1850	24.0	58.0	4.70
A9213/16	3/16	4.76	0.1875	29.0	56.0	4.76
A9214.8	-	4.80	0.1890	26.0	62.0	4.80
A9214.9	-	4.90	0.1929	26.0	62.0	4.90
A9215.0	-	5.00	0.1969	26.0	62.0	5.00
A9215.1	-	5.10	0.2008	26.0	62.0	5.10
A92113/64	13/64	5.16	0.2031	30.0	57.0	5.16
A9215.2	-	5.20	0.2047	26.0	62.0	5.20
A9215.3	-	5.30	0.2087	26.0	62.0	5.30
A9215.4	-	5.40	0.2126	28.0	66.0	5.40
A9215.5	-	5.50	0.2165	28.0	66.0	5.50
A9217/32	7/32	5.56	0.2188	32.0	60.0	5.56
A9215.6	-	5.60	0.2205	28.0	66.0	5.60
A9215.7	-	5.70	0.2244	28.0	66.0	5.70
A9215.8	-	5.80	0.2283	28.0	66.0	5.80
A9215.9	-	5.90	0.2323	28.0	66.0	5.90
A92115/64	15/64	5.95	0.2344	33.0	62.0	5.95
A9216.0	-	6.00	0.2362	28.0	66.0	6.00
A9216.1	-	6.10	0.2402	31.0	70.0	6.10
A9216.2	-	6.20	0.2441	31.0	70.0	6.20
A9216.3	-	6.30	0.2480	31.0	70.0	6.30
A9211/4	1/4	6.35	0.2500	35.0	64.0	6.35
A9216.4	-	6.40	0.2520	31.0	70.0	6.40
A9216.5	-	6.50	0.2559	31.0	70.0	6.50
A9216.6	-	6.60	0.2598	31.0	70.0	6.60
A9216.7	-	6.70	0.2638	31.0	70.0	6.70



Producto	DC	DC	DC	LCF	OAL	DCON MS
	(inch)	(mm)	(inch)	(mm)	(mm)	(mm)
A92117/64	17/64	6.75	0.2656	37.0	67.0	6.75
A9216.8	–	6.80	0.2677	34.0	74.0	6.80
A9216.9	–	6.90	0.2717	34.0	74.0	6.90
A9217.0	–	7.00	0.2756	34.0	74.0	7.00
A9217.1	–	7.10	0.2795	34.0	74.0	7.10
A9219/32	9/32	7.14	0.2813	38.0	68.0	7.14
A9217.2	–	7.20	0.2835	34.0	74.0	7.20
A9217.3	–	7.30	0.2874	34.0	74.0	7.30
A9217.4	–	7.40	0.2913	34.0	74.0	7.40
A9217.5	–	7.50	0.2953	34.0	74.0	7.50
A92119/64	19/64	7.54	0.2969	40.0	70.0	7.54
A9217.6	–	7.60	0.2992	37.0	79.0	7.60
A9217.7	–	7.70	0.3031	37.0	79.0	7.70
A9217.8	–	7.80	0.3071	37.0	79.0	7.80
A9217.9	–	7.90	0.3110	37.0	79.0	7.90
A9215/16	5/16	7.94	0.3125	41.0	71.0	7.94
A9218.0	–	8.00	0.3150	37.0	79.0	8.00
A9218.1	–	8.10	0.3189	37.0	79.0	8.10
A9218.2	–	8.20	0.3228	37.0	79.0	8.20
A9218.3	–	8.30	0.3268	37.0	79.0	8.30
A92121/64	21/64	8.33	0.3281	43.0	75.0	8.33
A9218.4	–	8.40	0.3307	37.0	79.0	8.40
A9218.5	–	8.50	0.3346	37.0	79.0	8.50
A9218.6	–	8.60	0.3386	40.0	84.0	8.60
A9218.7	–	8.70	0.3425	40.0	84.0	8.70
A92111/32	11/32	8.73	0.3438	43.0	76.0	8.73
A9218.8	–	8.80	0.3465	40.0	84.0	8.80
A9218.9	–	8.90	0.3504	40.0	84.0	8.90
A9219.0	–	9.00	0.3543	40.0	84.0	9.00
A9219.1	–	9.10	0.3583	40.0	84.0	9.10
A92123/64	23/64	9.13	0.3594	44.0	78.0	9.13
A9219.2	–	9.20	0.3622	40.0	84.0	9.20
A9219.3	–	9.30	0.3661	40.0	84.0	9.30
A9219.4	–	9.40	0.3701	40.0	84.0	9.40
A9219.5	–	9.50	0.3740	40.0	84.0	9.50
A9213/8	3/8	9.52	0.3750	46.0	79.0	9.52
A9219.6	–	9.60	0.3780	43.0	89.0	9.60

Producto	DC	DC	DC	LCF	OAL	DCON MS
	(inch)	(mm)	(inch)	(mm)	(mm)	(mm)
A9219.7	–	9.70	0.3819	43.0	89.0	9.70
A9219.8	–	9.80	0.3858	43.0	89.0	9.80
A9219.9	–	9.90	0.3898	43.0	89.0	9.90
A92125/64	25/64	9.92	0.3906	48.0	83.0	9.92
A92110.0	–	10.00	0.3937	43.0	89.0	10.00
A92110.2	–	10.20	0.4016	43.0	89.0	10.20
A92110.3	–	10.30	0.4055	43.0	89.0	10.30
A92113/32	13/32	10.32	0.4063	49.0	84.0	10.32
A92110.5	–	10.50	0.4134	43.0	89.0	10.50
A92127/64	27/64	10.72	0.4219	51.0	86.0	10.72
A92110.8	–	10.80	0.4252	47.0	95.0	10.80
A92111.0	–	11.00	0.4331	47.0	95.0	11.00
A9217/16	7/16	11.11	0.4375	52.0	87.0	11.11
A92111.5	–	11.50	0.4528	47.0	95.0	11.50
A92129/64	29/64	11.51	0.4531	54.0	90.0	11.51
A92111.8	–	11.80	0.4646	47.0	95.0	11.80
A92115/32	15/32	11.91	0.4688	54.0	92.0	11.91
A92112.0	–	12.00	0.4724	51.0	102.0	12.00
A92131/64	31/64	12.30	0.4844	56.0	94.0	12.30
A92112.5	–	12.50	0.4921	51.0	102.0	12.50
A9211/2	1/2	12.70	0.5000	57.0	95.0	12.70
A92113.0	–	13.00	0.5118	51.0	102.0	13.00
A92133/64	33/64	13.10	0.5156	60.0	98.0	13.10
A92113.5	–	13.50	0.5315	54.0	107.0	13.50
A92135/64	35/64	13.89	0.5469	64.0	102.0	13.89
A92114.0	–	14.00	0.5512	54.0	107.0	14.00
A9219/16	9/16	14.29	0.5625	64.0	102.0	14.29
A92114.5	–	14.50	0.5709	56.0	111.0	14.50
A92137/64	37/64	14.68	0.5781	67.0	105.0	14.68
A92114.75	–	14.75	0.5807	56.0	111.0	14.75
A92115.0	–	15.00	0.5906	56.0	111.0	15.00
A92119/32	19/32	15.08	0.5938	67.0	105.0	15.08
A92139/64	39/64	15.48	0.6094	70.0	108.0	15.48
A92115.5	–	15.50	0.6102	58.0	115.0	15.50
A9215/8	5/8	15.88	0.6250	70.0	108.0	15.88
A92116.0	–	16.00	0.6299	58.0	115.0	16.00



A002



Broca HSS Serie Corta, con la Punta Recubierta TiN

Broca versátil para taladrado manual y en máquina. Punta dividida a 118° especialmente diseñada para ayudar a autocentrar la broca cuando se taladra a mano y proporciona un agujero de tamaño más preciso. Apta para muchos materiales. El recubrimiento TiN-Tip mejora el rendimiento y prolonga la vida útil de la herramienta.

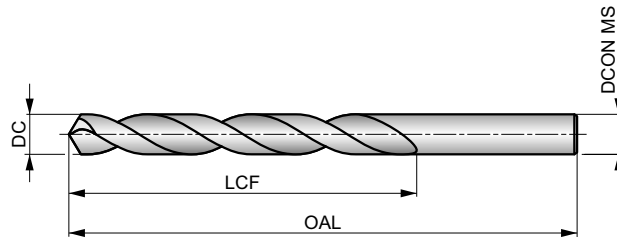

HSS	DIN 338	4xD
118°	TiN-Tip	
λ 20-35°	R	DC h8

Grupo de Material de la pieza adecuado y condiciones de velocidad de corte iniciales (m/min) y código de avance alfabético. Tablas con avance por revolución a partir de la pag.175.

P1.1 ■ 46 J	P1.2 ■ 52 J	P1.3 ■ 54 J	P2.1 ■ 40 J	P2.2 ■ 35 F	P2.3 ■ 31 F	P3.1 ■ 27 F	P3.2 ■ 21 F	P3.3 ■ 18 F	P4.1 ■ 16 F	P4.2 ■ 13 F	P4.3 ■ 11 E	M1.1 ■ 27 F	M1.2 ■ 23 F
M2.1 ■ 24 F	M2.2 ■ 20 F	M3.1 ■ 14 G	M3.2 ■ 12 G	M3.3 ■ 11 G	M4.1 ■ 16 C	K1.1 ■ 40 J	K1.2 ■ 30 E	K1.3 ■ 22 E	K2.1 ■ 34 E	K2.2 ■ 28 E	K2.3 ■ 22 E	K3.1 ■ 30 E	K3.2 ■ 23 E
K3.3 ■ 19 E	K4.1 ■ 28 E	K4.2 ■ 21 E	K4.3 ■ 16 E	K4.4 ■ 13 E	K4.5 ■ 11 E	K5.1 ■ 32 E	K5.2 ■ 24 E	K5.3 ■ 19 E	N1.1 ■ 41 K	N1.2 ■ 31 K	N1.3 ■ 21 J	N2.1 ■ 51 I	N2.2 ■ 46 I
N2.3 ■ 33 I	N3.1 ■ 56 H	N3.2 ■ 33 I	N3.3 ■ 17 G	N4.1 ■ 30 I	N4.2 ■ 50 H	N4.3 ■ 35 F	S1.1 ■ 23 F	S1.2 ■ 13 D	S1.3 ■ 7 B	S2.1 ■ 9 E	S2.2 ■ 4 A	S3.1 ■ 7 E	S3.2 ■ 3 A
S4.1 ■ 5 E	S4.2 ■ 2 A												

DC < 2mm Brillante; DC >= 2mm Punta rectificada en cruz y recubierta TiN
Los productos de esta serie también están disponibles en forma de Set. Por favor, vea A087, A089 A094, A095 o A099.

Producto	DC (inch)	DC (mm)	DC (inch)	LCF (mm)	OAL (mm)	DCON MS (mm)
A0021.0	-	1.00	0.0394	12.0	34.0	1.00
A0021.1	-	1.10	0.0433	14.0	36.0	1.10
A0023/64	3/64	1.19	0.0469	16.0	38.0	1.19
A0021.2	-	1.20	0.0472	16.0	38.0	1.20
A0021.3	-	1.30	0.0512	16.0	38.0	1.30
A0021.4	-	1.40	0.0551	18.0	40.0	1.40
A0021.5	-	1.50	0.0591	18.0	40.0	1.50
A0021/16	1/16	1.59	0.0625	20.0	43.0	1.59
A0021.6	-	1.60	0.0630	20.0	43.0	1.60
A0021.7	-	1.70	0.0669	20.0	43.0	1.70
A0021.8	-	1.80	0.0709	22.0	46.0	1.80
A0021.9	-	1.90	0.0748	22.0	46.0	1.90
A0025/64	5/64	1.98	0.0781	24.0	49.0	1.98
A0022.0	-	2.00	0.0787	24.0	49.0	2.00
A0022.1	-	2.10	0.0827	24.0	49.0	2.10
A0022.2	-	2.20	0.0866	27.0	53.0	2.20
A0022.3	-	2.30	0.0906	27.0	53.0	2.30
A0023/32	3/32	2.38	0.0938	30.0	57.0	2.38
A0022.4	-	2.40	0.0945	30.0	57.0	2.40
A0022.5	-	2.50	0.0984	30.0	57.0	2.50
A0022.6	-	2.60	0.1024	30.0	57.0	2.60
A0022.7	-	2.70	0.1063	33.0	61.0	2.70
A0027/64	7/64	2.78	0.1094	33.0	61.0	2.78
A0022.8	-	2.80	0.1102	33.0	61.0	2.80

Producto	DC (inch)	DC (mm)	DC (inch)	LCF (mm)	OAL (mm)	DCON MS (mm)
A0022.9	-	2.90	0.1142	33.0	61.0	2.90
A0023.0	-	3.00	0.1181	33.0	61.0	3.00
A0023.1	-	3.10	0.1220	36.0	65.0	3.10
A0021/8	1/8	3.18	0.1250	36.0	65.0	3.18
A0023.2	-	3.20	0.1260	36.0	65.0	3.20
A0023.25	-	3.25	0.1280	36.0	65.0	3.25
A0023.3	-	3.30	0.1299	36.0	65.0	3.30
A0023.4	-	3.40	0.1339	39.0	70.0	3.40
A0023.5	-	3.50	0.1378	39.0	70.0	3.50
A0029/64	9/64	3.57	0.1406	39.0	70.0	3.57
A0023.6	-	3.60	0.1417	39.0	70.0	3.60
A0023.7	-	3.70	0.1457	39.0	70.0	3.70
A0023.8	-	3.80	0.1496	43.0	75.0	3.80
A0023.9	-	3.90	0.1535	43.0	75.0	3.90
A0025/32	5/32	3.97	0.1563	43.0	75.0	3.97
A0024.0	-	4.00	0.1575	43.0	75.0	4.00
A0024.1	-	4.10	0.1614	43.0	75.0	4.10
A0024.2	-	4.20	0.1654	43.0	75.0	4.20
A0024.3	-	4.30	0.1693	47.0	80.0	4.30
A00211/64	11/64	4.37	0.1719	47.0	80.0	4.37
A0024.4	-	4.40	0.1732	47.0	80.0	4.40
A0024.5	-	4.50	0.1772	47.0	80.0	4.50
A0024.6	-	4.60	0.1811	47.0	80.0	4.60
A0024.7	-	4.70	0.1850	47.0	80.0	4.70



Producto	DC	DC	DC	LCF	OAL	D CON MS
	(inch)	(mm)	(inch)	(mm)	(mm)	(mm)
A0023/16	3/16	4.76	0.1875	52.0	86.0	4.76
A0024.8	–	4.80	0.1890	52.0	86.0	4.80
A0024.9	–	4.90	0.1929	52.0	86.0	4.90
A0025.0	–	5.00	0.1969	52.0	86.0	5.00
A0025.1	–	5.10	0.2008	52.0	86.0	5.10
A00213/64	13/64	5.16	0.2031	52.0	86.0	5.16
A0025.2	–	5.20	0.2047	52.0	86.0	5.20
A0025.3	–	5.30	0.2087	52.0	86.0	5.30
A0025.4	–	5.40	0.2126	57.0	93.0	5.40
A0025.5	–	5.50	0.2165	57.0	93.0	5.50
A0027/32	7/32	5.56	0.2188	57.0	93.0	5.56
A0025.6	–	5.60	0.2205	57.0	93.0	5.60
A0025.7	–	5.70	0.2244	57.0	93.0	5.70
A0025.8	–	5.80	0.2283	57.0	93.0	5.80
A0025.9	–	5.90	0.2323	57.0	93.0	5.90
A00215/64	15/64	5.95	0.2344	57.0	93.0	5.95
A0026.0	–	6.00	0.2362	57.0	93.0	6.00
A0026.1	–	6.10	0.2402	63.0	101.0	6.10
A0026.2	–	6.20	0.2441	63.0	101.0	6.20
A0026.3	–	6.30	0.2480	63.0	101.0	6.30
A0021/4	1/4	6.35	0.2500	63.0	101.0	6.35
A0026.4	–	6.40	0.2520	63.0	101.0	6.40
A0026.5	–	6.50	0.2559	63.0	101.0	6.50
A0026.6	–	6.60	0.2598	63.0	101.0	6.60
A0026.7	–	6.70	0.2638	63.0	101.0	6.70
A00217/64	17/64	6.75	0.2656	69.0	109.0	6.75
A0026.8	–	6.80	0.2677	69.0	109.0	6.80
A0026.9	–	6.90	0.2717	69.0	109.0	6.90
A0027.0	–	7.00	0.2756	69.0	109.0	7.00
A0027.1	–	7.10	0.2795	69.0	109.0	7.10
A0029/32	9/32	7.14	0.2813	69.0	109.0	7.14
A0027.2	–	7.20	0.2835	69.0	109.0	7.20
A0027.3	–	7.30	0.2874	69.0	109.0	7.30
A0027.4	–	7.40	0.2913	69.0	109.0	7.40
A0027.5	–	7.50	0.2953	69.0	109.0	7.50
A00219/64	19/64	7.54	0.2969	75.0	117.0	7.54
A0027.6	–	7.60	0.2992	75.0	117.0	7.60
A0027.7	–	7.70	0.3031	75.0	117.0	7.70
A0027.8	–	7.80	0.3071	75.0	117.0	7.80
A0027.9	–	7.90	0.3110	75.0	117.0	7.90
A0025/16	5/16	7.94	0.3125	75.0	117.0	7.94
A0028.0	–	8.00	0.3150	75.0	117.0	8.00
A0028.1	–	8.10	0.3189	75.0	117.0	8.10
A0028.2	–	8.20	0.3228	75.0	117.0	8.20
A0028.3	–	8.30	0.3268	75.0	117.0	8.30
A00221/64	21/64	8.33	0.3281	75.0	117.0	8.33
A0028.4	–	8.40	0.3307	75.0	117.0	8.40
A0028.5	–	8.50	0.3346	75.0	117.0	8.50
A0028.6	–	8.60	0.3386	81.0	125.0	8.60
A0028.7	–	8.70	0.3425	81.0	125.0	8.70
A00211/32	11/32	8.73	0.3438	81.0	125.0	8.73
A0028.8	–	8.80	0.3465	81.0	125.0	8.80
A0028.9	–	8.90	0.3504	81.0	125.0	8.90
A0029.0	–	9.00	0.3543	81.0	125.0	9.00
A0029.1	–	9.10	0.3583	81.0	125.0	9.10
A00223/64	23/64	9.13	0.3594	81.0	125.0	9.13
A0029.2	–	9.20	0.3622	81.0	125.0	9.20
A0029.3	–	9.30	0.3661	81.0	125.0	9.30
A0029.4	–	9.40	0.3701	81.0	125.0	9.40
A0029.5	–	9.50	0.3740	81.0	125.0	9.50
A0023/8	3/8	9.52	0.3750	87.0	133.0	9.52
A0029.6	–	9.60	0.3780	87.0	133.0	9.60
A0029.7	–	9.70	0.3819	87.0	133.0	9.70
A0029.8	–	9.80	0.3858	87.0	133.0	9.80
A0029.9	–	9.90	0.3898	87.0	133.0	9.90
A00225/64	25/64	9.92	0.3906	87.0	133.0	9.92
A00210.0	–	10.00	0.3937	87.0	133.0	10.00

Producto	DC	DC	DC	LCF	OAL	D CON MS
	(inch)	(mm)	(inch)	(mm)	(mm)	(mm)
A00210.1	–	10.10	0.3976	87.0	133.0	10.10
A00210.2	–	10.20	0.4016	87.0	133.0	10.20
A00210.3	–	10.30	0.4055	87.0	133.0	10.30
A00213/32	13/32	10.32	0.4063	87.0	133.0	10.32
A00210.4	–	10.40	0.4094	87.0	133.0	10.40
A00210.5	–	10.50	0.4134	87.0	133.0	10.50
A00210.6	–	10.60	0.4173	87.0	133.0	10.60
A00210.7	–	10.70	0.4213	94.0	142.0	10.70
A00227/64	27/64	10.72	0.4219	94.0	142.0	10.72
A00210.8	–	10.80	0.4252	94.0	142.0	10.80
A00210.9	–	10.90	0.4291	94.0	142.0	10.90
A00211.0	–	11.00	0.4331	94.0	142.0	11.00
A00211.1	–	11.10	0.4370	94.0	142.0	11.10
A0027/16	7/16	11.11	0.4375	94.0	142.0	11.11
A00211.2	–	11.20	0.4409	94.0	142.0	11.20
A00211.3	–	11.30	0.4449	94.0	142.0	11.30
A00211.4	–	11.40	0.4488	94.0	142.0	11.40
A00211.5	–	11.50	0.4528	94.0	142.0	11.50
A00229/64	29/64	11.51	0.4531	94.0	142.0	11.51
A00211.6	–	11.60	0.4567	94.0	142.0	11.60
A00211.7	–	11.70	0.4606	94.0	142.0	11.70
A00211.8	–	11.80	0.4646	94.0	142.0	11.80
A00211.9	–	11.90	0.4685	101.0	151.0	11.90
A00215/32	15/32	11.91	0.4688	101.0	151.0	11.91
A00212.0	–	12.00	0.4724	101.0	151.0	12.00
A00212.1	–	12.10	0.4764	101.0	151.0	12.10
A00212.2	–	12.20	0.4803	101.0	151.0	12.20
A00212.3	–	12.30	0.4843	101.0	151.0	12.30
A00231/64	31/64	12.30	0.4844	101.0	151.0	12.30
A00212.4	–	12.40	0.4882	101.0	151.0	12.40
A00212.5	–	12.50	0.4921	101.0	151.0	12.50
A00212.6	–	12.60	0.4961	101.0	151.0	12.60
A00212.7	–	12.70	0.5000	101.0	151.0	12.70
A0021/2	1/2	12.70	0.5000	101.0	151.0	12.70
A00212.8	–	12.80	0.5039	101.0	151.0	12.80
A00212.9	–	12.90	0.5079	101.0	151.0	12.90
A00213.0	–	13.00	0.5118	101.0	151.0	13.00
A00233/64	33/64	13.10	0.5156	101.0	151.0	13.10
A00213.1	–	13.10	0.5157	101.0	151.0	13.10
A00213.2	–	13.20	0.5197	101.0	151.0	13.20
A00213.25	–	13.25	0.5217	108.0	160.0	13.25
A00213.3	–	13.30	0.5236	108.0	160.0	13.30
A00213.4	–	13.40	0.5276	108.0	160.0	13.40
A00217/32	17/32	13.49	0.5313	108.0	160.0	13.49
A00213.5	–	13.50	0.5315	108.0	160.0	13.50
A00213.6	–	13.60	0.5354	108.0	160.0	13.60
A00213.7	–	13.70	0.5394	108.0	160.0	13.70
A00213.75	–	13.75	0.5413	108.0	160.0	13.75
A00213.8	–	13.80	0.5433	108.0	160.0	13.80
A00235/64	35/64	13.89	0.5469	108.0	160.0	13.89
A00213.9	–	13.90	0.5472	108.0	160.0	13.90
A00214.0	–	14.00	0.5512	108.0	160.0	14.00
A00214.25	–	14.25	0.5610	114.0	169.0	14.25
A0029/16	9/16	14.29	0.5625	114.0	169.0	14.29
A00214.5	–	14.50	0.5709	114.0	169.0	14.50
A00237/64	37/64	14.68	0.5781	114.0	169.0	14.68
A00214.75	–	14.75	0.5807	114.0	169.0	14.75
A00215.0	–	15.00	0.5906	114.0	169.0	15.00
A00219/32	19/32	15.08	0.5938	120.0	178.0	15.08
A00215.25	–	15.25	0.6004	120.0	178.0	15.25
A00239/64	39/64	15.48	0.6094	120.0	178.0	15.48
A00215.5	–	15.50	0.6102	120.0	178.0	15.50
A00215.75	–	15.75	0.6201	120.0	178.0	15.75
A0025/8	5/8	15.88	0.6250	120.0	178.0	15.88
A00216.0	–	16.00	0.6299	120.0	178.0	16.00



A002S



Broca HSS Serie Corta, con la Punta Recubierta TiN, en Blister

Broca versátil para taladrado manual y en máquina. Punta dividida a 118° especialmente diseñada para ayudar a autocentrar la broca cuando se taladra a mano y proporciona un agujero de tamaño más preciso. Apta para muchos materiales. El recubrimiento TiN-Tip mejora el rendimiento y prolonga la vida útil de la herramienta.

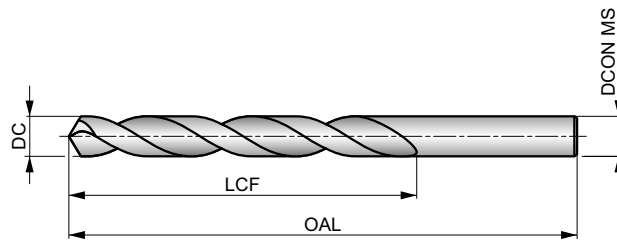

HSS	DIN 338	4xD
118°	TiN-Tip	
λ 20-35°	R	DC h8

Grupo de Material de la pieza adecuado y condiciones de velocidad de corte iniciales (m/min) y código de avance alfabético. Tablas con avance por revolución a partir de la pag.175.

P1.1 ■ 46 J	P1.2 ■ 52 J	P1.3 ■ 54 J	P2.1 ■ 40 J	P2.2 ■ 35 F	P2.3 ■ 31 F	P3.1 ■ 27 F	P3.2 ■ 21 F	P3.3 ■ 18 F	P4.1 ■ 16 F	P4.2 ■ 13 F	P4.3 ■ 11 E	M1.1 ■ 27 F	M1.2 ■ 23 F
M2.1 ■ 24 F	M2.2 ■ 20 F	M3.1 ■ 14 G	M3.2 ■ 12 G	M3.3 ■ 11 G	M4.1 ■ 16 C	K1.1 ■ 40 J	K1.2 ■ 30 E	K1.3 ■ 22 E	K2.1 ■ 34 E	K2.2 ■ 28 E	K2.3 ■ 22 E	K3.1 ■ 30 E	K3.2 ■ 23 E
K3.3 ■ 19 E	K4.1 ■ 28 E	K4.2 ■ 21 E	K4.3 ■ 16 E	K4.4 ■ 13 E	K4.5 ■ 11 E	K5.1 ■ 32 E	K5.2 ■ 24 E	K5.3 ■ 19 E	N1.1 ■ 41 K	N1.2 ■ 31 K	N1.3 ■ 21 J	N2.1 ■ 51 I	N2.2 ■ 46 I
N2.3 ■ 33 I	N3.1 ■ 56 H	N3.2 ■ 33 I	N3.3 ■ 17 G	N4.1 ■ 30 I	N4.2 ■ 50 H	N4.3 ■ 35 F	S1.1 ■ 23 F	S1.2 ■ 13 D	S1.3 ■ 7 B	S2.1 ■ 9 E	S2.2 ■ 4 A	S3.1 ■ 7 E	S3.2 ■ 3 A
S4.1 ■ 5 E	S4.2 ■ 2 A												

DC <= 5mm Se vende en paquetes de 2.

Producto	DC (inch)	DC (mm)	DC (inch)	LCF (mm)	OAL (mm)	DCON MS (mm)
A002S2.0	-	2.00	0.0787	24.0	49.0	2.00
A002S2.5	-	2.50	0.0984	30.0	57.0	2.50
A002S3.0	-	3.00	0.1181	33.0	61.0	3.00
A002S1/8	1/8	3.18	0.1250	36.0	65.0	3.18
A002S3.2	-	3.20	0.1260	36.0	65.0	3.20
A002S3.3	-	3.30	0.1299	36.0	65.0	3.30
A002S3.5	-	3.50	0.1378	39.0	70.0	3.50
A002S5/32	5/32	3.97	0.1563	43.0	75.0	3.97
A002S4.0	-	4.00	0.1575	43.0	75.0	4.00
A002S4.1	-	4.10	0.1614	43.0	75.0	4.10
A002S4.2	-	4.20	0.1654	43.0	75.0	4.20
A002S4.5	-	4.50	0.1772	47.0	80.0	4.50
A002S3/16	3/16	4.76	0.1875	52.0	86.0	4.76
A002S5.0	-	5.00	0.1969	52.0	86.0	5.00
A002S13/64	13/64	5.16	0.2031	52.0	86.0	5.16
A002S5.5	-	5.50	0.2165	57.0	93.0	5.50
A002S7/32	7/32	5.56	0.2188	57.0	93.0	5.56
A002S6.0	-	6.00	0.2362	57.0	93.0	6.00
A002S1/4	1/4	6.35	0.2500	63.0	101.0	6.35
A002S6.5	-	6.50	0.2559	63.0	101.0	6.50

Producto	DC (inch)	DC (mm)	DC (inch)	LCF (mm)	OAL (mm)	DCON MS (mm)
A002S17/64	17/64	6.75	0.2656	69.0	109.0	6.75
A002S6.8	-	6.80	0.2677	69.0	109.0	6.80
A002S7.0	-	7.00	0.2756	69.0	109.0	7.00
A002S7.5	-	7.50	0.2953	69.0	109.0	7.50
A002S5/16	5/16	7.94	0.3125	75.0	117.0	7.94
A002S8.0	-	8.00	0.3150	75.0	117.0	8.00
A002S8.2	-	8.20	0.3228	75.0	117.0	8.20
A002S8.5	-	8.50	0.3346	75.0	117.0	8.50
A002S9.0	-	9.00	0.3543	81.0	125.0	9.00
A002S9.5	-	9.50	0.3740	81.0	125.0	9.50
A002S3/8	3/8	9.52	0.3750	87.0	133.0	9.52
A002S10.0	-	10.00	0.3937	87.0	133.0	10.00
A002S10.2	-	10.20	0.4016	87.0	133.0	10.20
A002S10.5	-	10.50	0.4134	87.0	133.0	10.50
A002S11.0	-	11.00	0.4331	94.0	142.0	11.00
A002S11.5	-	11.50	0.4528	94.0	142.0	11.50
A002S12.0	-	12.00	0.4724	101.0	151.0	12.00
A002S12.5	-	12.50	0.4921	101.0	151.0	12.50
A002S1/2	1/2	12.70	0.5000	101.0	151.0	12.70
A002S13.0	-	13.00	0.5118	101.0	151.0	13.00



A100



Broca HSS Serie Corta, con Acabado Templado al Vapor

Un gran broca versátil todoterreno con punta convencional a 118°, que proporciona gran resistencia y es fácil de reafilar, lo que lo hace muy rentable. Utilizable en aplicaciones manuales y en máquinas. El acabado templado al vapor retiene el fluido de corte y evita la soldadura de la viruta a la herramienta. Adecuada para la mayoría de materiales.

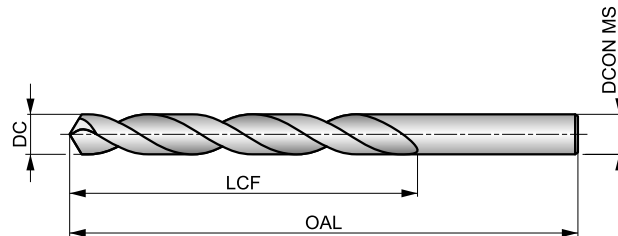

HSS	DIN 338	4xD
118°	ST	
λ 20-35°	R	DC h8

Grupo de Material de la pieza adecuado y condiciones de velocidad de corte iniciales (m/min) y código de avance alfabético. Tablas con avance por revolución a partir de la pag.175.

P1.1 ■ 33 H	P1.2 ■ 37 H	P1.3 ■ 38 H	P2.1 ■ 28 H	P2.2 ■ 25 F	P2.3 ■ 22 E	P3.1 ■ 19 F	P3.2 ■ 15 F	P3.3 ■ 13 E	P4.1 ■ 11 F	P4.2 ■ 10 E	P4.3 ■ 8 D	M1.1 ■ 21 E	M1.2 ■ 17 E
M2.1 ■ 18 E	M2.2 ■ 15 E	M3.1 ■ 9 G	M3.2 ■ 8 G	M3.3 ■ 7 G	M4.1 ■ 9 C	K1.1 ■ 30 H	K1.2 ■ 22 F	K1.3 ■ 17 F	K2.1 ■ 25 E	K2.2 ■ 20 E	K2.3 ■ 16 E	K3.1 ■ 22 E	K3.2 ■ 17 E
K3.3 ■ 13 E	K4.1 ■ 20 E	K4.2 ■ 15 E	K4.3 ■ 11 E	K4.4 ■ 10 E	K4.5 ■ 8 E	K5.1 ■ 23 E	K5.2 ■ 17 E	K5.3 ■ 13 E	N1.1 ■ 33 J	N1.2 ■ 25 J	N1.3 ■ 17 I	N2.1 ■ 42 H	N2.2 ■ 37 H
N2.3 ■ 27 H	N3.1 ■ 59 H	N3.2 ■ 35 I	N3.3 ■ 18 G	N4.1 ■ 30 J	N4.2 ■ 28 H	N4.3 ■ 14 F	S1.1 ■ 23 E	S1.2 ■ 12 D	S1.3 ■ 6 B	S2.1 ■ 8 E	S2.2 ■ 4 A	S3.1 ■ 6 E	S3.2 ■ 3 A
S4.1 ■ 5 E	S4.2 ■ 2 A												

DC <= 1mm; 3/64"; N60. Brillante

Los productos de esta serie también están disponibles en forma de Set. Por favor, vea A190, A191 o A199.

Producto	DC	DC	DC	LCF	OAL	DCON MS	Producto	DC	DC	DC	LCF	OAL	DCON MS
	(inch)	(mm)	(inch)	(mm)	(mm)	(mm)		(inch)	(mm)	(inch)	(mm)	(mm)	(mm)
A100.2	-	0.20	0.0079	2.5	19.0	0.20	A100.6	-	0.60	0.0236	7.0	24.0	0.60
A100.25	-	0.25	0.0098	3.0	19.0	0.25	A100N73	N73	0.61	0.0240	8.0	26.0	0.61
A100.3	-	0.30	0.0118	3.0	19.0	0.30	A100.62	-	0.62	0.0244	8.0	26.0	0.62
A100.32	-	0.32	0.0126	4.0	19.0	0.32	A100N72	N72	0.64	0.0250	8.0	26.0	0.64
A100N80	N80	0.34	0.0135	4.0	19.0	0.34	A100.65	-	0.65	0.0256	8.0	26.0	0.65
A100.35	-	0.35	0.0138	4.0	19.0	0.35	A100N71	N71	0.66	0.0260	8.0	26.0	0.66
A100N79	N79	0.37	0.0145	4.0	19.0	0.37	A100.68	-	0.68	0.0268	9.0	28.0	0.68
A100.38	-	0.38	0.0150	4.0	19.0	0.38	A100.7	-	0.70	0.0276	9.0	28.0	0.70
A1001/64	1/64	0.40	0.0156	5.0	20.0	0.40	A100N70	N70	0.71	0.0280	9.0	28.0	0.71
A100.4	-	0.40	0.0157	5.0	20.0	0.40	A100.72	-	0.72	0.0283	9.0	28.0	0.72
A100N78	N78	0.41	0.0160	5.0	20.0	0.41	A100N69	N69	0.74	0.0292	9.0	28.0	0.74
A100.42	-	0.42	0.0165	5.0	20.0	0.42	A100.75	-	0.75	0.0295	9.0	28.0	0.75
A100.45	-	0.45	0.0177	5.0	20.0	0.45	A100.78	-	0.78	0.0307	10.0	30.0	0.78
A100N77	N77	0.46	0.0180	5.0	20.0	0.46	A1001/32	1/32	0.79	0.0313	10.0	30.0	0.79
A100.48	-	0.48	0.0189	5.0	20.0	0.48	A100N68	N68	0.79	0.0310	10.0	30.0	0.79
A100.5	-	0.50	0.0197	6.0	22.0	0.50	A100.8	-	0.80	0.0315	10.0	30.0	0.80
A100N76	N76	0.51	0.0200	6.0	22.0	0.51	A100N67	N67	0.81	0.0320	10.0	30.0	0.81
A100.52	-	0.52	0.0205	6.0	22.0	0.52	A100.82	-	0.82	0.0323	10.0	30.0	0.82
A100N75	N75	0.53	0.0210	6.0	22.0	0.53	A100N66	N66	0.84	0.0330	10.0	30.0	0.84
A100.55	-	0.55	0.0217	7.0	24.0	0.55	A100.85	-	0.85	0.0335	10.0	30.0	0.85
A100N74	N74	0.57	0.0225	7.0	24.0	0.57	A100.88	-	0.88	0.0346	11.0	32.0	0.88
A100.58	-	0.58	0.0228	7.0	24.0	0.58	A100N65	N65	0.89	0.0350	11.0	32.0	0.89



Producto	DC	DC	DC	LCF	OAL	D CON MS
	(inch)	(mm)	(inch)	(mm)	(mm)	(mm)
A100.9	—	0.90	0.0354	11.0	32.0	0.90
A100N64	N64	0.91	0.0360	11.0	32.0	0.91
A100.92	—	0.92	0.0362	11.0	32.0	0.92
A100N63	N63	0.94	0.0370	11.0	32.0	0.94
A100.95	—	0.95	0.0374	11.0	32.0	0.95
A100N62	N62	0.97	0.0380	12.0	34.0	0.97
A100.98	—	0.98	0.0386	12.0	34.0	0.98
A100N61	N61	0.99	0.0390	12.0	34.0	0.99
A1001.0	—	1.00	0.0394	12.0	34.0	1.00
A100N60	N60	1.02	0.0400	12.0	34.0	1.02
A100N59	N59	1.04	0.0410	12.0	34.0	1.04
A1001.05	—	1.05	0.0413	12.0	34.0	1.05
A100N58	N58	1.07	0.0420	14.0	36.0	1.07
A100N57	N57	1.09	0.0430	14.0	36.0	1.09
A1001.1	—	1.10	0.0433	14.0	36.0	1.10
A1001.15	—	1.15	0.0453	14.0	36.0	1.15
A100N56	N56	1.18	0.0465	14.0	36.0	1.18
A1003/64	3/64	1.19	0.0469	16.0	38.0	1.19
A1001.2	—	1.20	0.0472	16.0	38.0	1.20
A1001.25	—	1.25	0.0492	16.0	38.0	1.25
A1001.3	—	1.30	0.0512	16.0	38.0	1.30
A100N55	N55	1.32	0.0520	16.0	38.0	1.32
A1001.35	—	1.35	0.0531	18.0	40.0	1.35
A1001.4	—	1.40	0.0551	18.0	40.0	1.40
A100N54	N54	1.40	0.0550	18.0	40.0	1.40
A1001.45	—	1.45	0.0571	18.0	40.0	1.45
A1001.5	—	1.50	0.0591	18.0	40.0	1.50
A100N53	N53	1.51	0.0595	20.0	43.0	1.51
A1001.55	—	1.55	0.0610	20.0	43.0	1.55
A1001/16	1/16	1.59	0.0625	20.0	43.0	1.59
A1001.6	—	1.60	0.0630	20.0	43.0	1.60
A100N52	N52	1.61	0.0635	20.0	43.0	1.61
A1001.65	—	1.65	0.0650	20.0	43.0	1.65
A1001.7	—	1.70	0.0669	20.0	43.0	1.70
A100N51	N51	1.70	0.0670	22.0	46.0	1.70
A1001.75	—	1.75	0.0689	22.0	46.0	1.75
A100N50	N50	1.78	0.0700	22.0	46.0	1.78
A1001.8	—	1.80	0.0709	22.0	46.0	1.80
A1001.85	—	1.85	0.0728	22.0	46.0	1.85
A100N49	N49	1.85	0.0730	22.0	46.0	1.85
A1001.9	—	1.90	0.0748	22.0	46.0	1.90
A100N48	N48	1.93	0.0760	24.0	49.0	1.93
A1001.95	—	1.95	0.0768	24.0	49.0	1.95
A1005/64	5/64	1.98	0.0781	24.0	49.0	1.98
A100N47	N47	1.99	0.0785	24.0	49.0	1.99
A1002.0	—	2.00	0.0787	24.0	49.0	2.00
A1002.05	—	2.05	0.0807	24.0	49.0	2.05
A100N46	N46	2.06	0.0810	24.0	49.0	2.06
A100N45	N45	2.08	0.0820	24.0	49.0	2.08
A1002.1	—	2.10	0.0827	24.0	49.0	2.10
A1002.15	—	2.15	0.0846	27.0	53.0	2.15
A100N44	N44	2.18	0.0860	27.0	53.0	2.18
A1002.2	—	2.20	0.0866	27.0	53.0	2.20
A1002.25	—	2.25	0.0886	27.0	53.0	2.25
A100N43	N43	2.26	0.0890	27.0	53.0	2.26
A1002.3	—	2.30	0.0906	27.0	53.0	2.30
A1002.35	—	2.35	0.0925	27.0	53.0	2.35
A1003/32	3/32	2.38	0.0938	30.0	57.0	2.38
A100N42	N42	2.38	0.0935	30.0	57.0	2.38
A1002.4	—	2.40	0.0945	30.0	57.0	2.40
A100N41	N41	2.44	0.0960	30.0	57.0	2.44
A1002.45	—	2.45	0.0965	30.0	57.0	2.45

Producto	DC	DC	DC	LCF	OAL	D CON MS
	(inch)	(mm)	(inch)	(mm)	(mm)	(mm)
A100N40	N40	2.49	0.0980	30.0	57.0	2.49
A1002.5	—	2.50	0.0984	30.0	57.0	2.50
A100N39	N39	2.53	0.0995	30.0	57.0	2.53
A1002.55	—	2.55	0.1004	30.0	57.0	2.55
A100N38	N38	2.58	0.1015	30.0	57.0	2.58
A1002.6	—	2.60	0.1024	30.0	57.0	2.60
A100N37	N37	2.64	0.1040	30.0	57.0	2.64
A1002.65	—	2.65	0.1043	30.0	57.0	2.65
A1002.7	—	2.70	0.1063	33.0	61.0	2.70
A100N36	N36	2.71	0.1065	33.0	61.0	2.71
A1002.75	—	2.75	0.1083	33.0	61.0	2.75
A1007/64	7/64	2.78	0.1094	33.0	61.0	2.78
A100N35	N35	2.79	0.1100	33.0	61.0	2.79
A1002.8	—	2.80	0.1102	33.0	61.0	2.80
A100N34	N34	2.82	0.1110	33.0	61.0	2.82
A1002.85	—	2.85	0.1122	33.0	61.0	2.85
A100N33	N33	2.87	0.1130	33.0	61.0	2.87
A1002.9	—	2.90	0.1142	33.0	61.0	2.90
A1002.95	—	2.95	0.1161	33.0	61.0	2.95
A100N32	N32	2.95	0.1160	33.0	61.0	2.95
A1003.0	—	3.00	0.1181	33.0	61.0	3.00
A100N31	N31	3.05	0.1200	36.0	65.0	3.05
A1003.1	—	3.10	0.1220	36.0	65.0	3.10
A1003.15	—	3.15	0.1240	36.0	65.0	3.15
A1001/8	1/8	3.18	0.1250	36.0	65.0	3.18
A1003.2	—	3.20	0.1260	36.0	65.0	3.20
A1003.25	—	3.25	0.1280	36.0	65.0	3.25
A100N30	N30	3.26	0.1285	36.0	65.0	3.26
A1003.3	—	3.30	0.1299	36.0	65.0	3.30
A1003.4	—	3.40	0.1339	39.0	70.0	3.40
A100N29	N29	3.45	0.1360	39.0	70.0	3.45
A1003.5	—	3.50	0.1378	39.0	70.0	3.50
A1009/64	9/64	3.57	0.1406	39.0	70.0	3.57
A100N28	N28	3.57	0.1405	39.0	70.0	3.57
A1003.6	—	3.60	0.1417	39.0	70.0	3.60
A100N27	N27	3.66	0.1440	39.0	70.0	3.66
A1003.7	—	3.70	0.1457	39.0	70.0	3.70
A100N26	N26	3.73	0.1470	39.0	70.0	3.73
A1003.75	—	3.75	0.1476	39.0	70.0	3.75
A1003.8	—	3.80	0.1496	43.0	75.0	3.80
A100N25	N25	3.80	0.1495	43.0	75.0	3.80
A100N24	N24	3.86	0.1520	43.0	75.0	3.86
A1003.9	—	3.90	0.1535	43.0	75.0	3.90
A100N23	N23	3.91	0.1540	43.0	75.0	3.91
A1005/32	5/32	3.97	0.1563	43.0	75.0	3.97
A100N22	N22	3.99	0.1570	43.0	75.0	3.99
A1004.0	—	4.00	0.1575	43.0	75.0	4.00
A100N21	N21	4.04	0.1590	43.0	75.0	4.04
A100N20	N20	4.09	0.1610	43.0	75.0	4.09
A1004.1	—	4.10	0.1614	43.0	75.0	4.10
A1004.2	—	4.20	0.1654	43.0	75.0	4.20
A100N19	N19	4.22	0.1660	43.0	75.0	4.22
A1004.25	—	4.25	0.1673	43.0	75.0	4.25
A1004.3	—	4.30	0.1693	47.0	80.0	4.30
A100N18	N18	4.31	0.1695	47.0	80.0	4.31
A10011/64	11/64	4.37	0.1719	47.0	80.0	4.37
A100N17	N17	4.39	0.1730	47.0	80.0	4.39
A1004.4	—	4.40	0.1732	47.0	80.0	4.40
A1004.5	—	4.50	0.1772	47.0	80.0	4.50
A100N16	N16	4.50	0.1770	47.0	80.0	4.50
A100N15	N15	4.57	0.1800	47.0	80.0	4.57
A1004.6	—	4.60	0.1811	47.0	80.0	4.60



Producto	DC	DC	DC	LCF	OAL	DCON MS
	(inch)	(mm)	(inch)	(mm)	(mm)	(mm)
A100N14	N14	4.62	0.1820	47.0	80.0	4.62
A1004.7	–	4.70	0.1850	47.0	80.0	4.70
A100N13	N13	4.70	0.1850	47.0	80.0	4.70
A1004.75	–	4.75	0.1870	47.0	80.0	4.75
A1003/16	3/16	4.76	0.1875	52.0	86.0	4.76
A1004.8	–	4.80	0.1890	52.0	86.0	4.80
A100N12	N12	4.80	0.1890	52.0	86.0	4.80
A100N11	N11	4.85	0.1910	52.0	86.0	4.85
A1004.9	–	4.90	0.1929	52.0	86.0	4.90
A100N10	N10	4.92	0.1935	52.0	86.0	4.92
A100N9	N9	4.98	0.1960	52.0	86.0	4.98
A1005.0	–	5.00	0.1969	52.0	86.0	5.00
A100N8	N8	5.06	0.1990	52.0	86.0	5.06
A1005.1	–	5.10	0.2008	52.0	86.0	5.10
A100N7	N7	5.11	0.2010	52.0	86.0	5.11
A10013/64	13/64	5.16	0.2031	52.0	86.0	5.16
A100N6	N6	5.18	0.2040	52.0	86.0	5.18
A1005.2	–	5.20	0.2047	52.0	86.0	5.20
A100N5	N5	5.22	0.2055	52.0	86.0	5.22
A1005.25	–	5.25	0.2067	52.0	86.0	5.25
A1005.3	–	5.30	0.2087	52.0	86.0	5.30
A100N4	N4	5.31	0.2090	57.0	93.0	5.31
A1005.4	–	5.40	0.2126	57.0	93.0	5.40
A100N3	N3	5.41	0.2130	57.0	93.0	5.41
A1005.5	–	5.50	0.2165	57.0	93.0	5.50
A1007/32	7/32	5.56	0.2188	57.0	93.0	5.56
A1005.6	–	5.60	0.2205	57.0	93.0	5.60
A100N2	N2	5.61	0.2210	57.0	93.0	5.61
A1005.7	–	5.70	0.2244	57.0	93.0	5.70
A1005.75	–	5.75	0.2264	57.0	93.0	5.75
A100N1	1	5.79	0.2280	57.0	93.0	5.79
A1005.8	–	5.80	0.2283	57.0	93.0	5.80
A1005.9	–	5.90	0.2323	57.0	93.0	5.90
A100A	A	5.94	0.2340	57.0	93.0	5.94
A10015/64	15/64	5.95	0.2344	57.0	93.0	5.95
A1006.0	–	6.00	0.2362	57.0	93.0	6.00
A100B	B	6.03	0.2380	63.0	101.0	6.03
A1006.1	–	6.10	0.2402	63.0	101.0	6.10
A100C	C	6.15	0.2420	63.0	101.0	6.15
A1006.2	–	6.20	0.2441	63.0	101.0	6.20
A1006.25	–	6.25	0.2461	63.0	101.0	6.25
A100D	D	6.25	0.2460	63.0	101.0	6.25
A1006.3	–	6.30	0.2480	63.0	101.0	6.30
A1001/4	1/4	6.35	0.2500	63.0	101.0	6.35
A100E	E	6.35	0.2500	63.0	101.0	6.35
A1006.4	–	6.40	0.2520	63.0	101.0	6.40
A1006.5	–	6.50	0.2559	63.0	101.0	6.50
A100F	F	6.53	0.2570	63.0	101.0	6.53
A1006.6	–	6.60	0.2598	63.0	101.0	6.60
A100G	G	6.63	0.2610	63.0	101.0	6.63
A1006.7	–	6.70	0.2638	63.0	101.0	6.70
A10017/64	17/64	6.75	0.2656	69.0	109.0	6.75
A1006.75	–	6.75	0.2657	69.0	109.0	6.75
A100H	H	6.76	0.2660	69.0	109.0	6.76
A1006.8	–	6.80	0.2677	69.0	109.0	6.80
A1006.9	–	6.90	0.2717	69.0	109.0	6.90
A100I	I	6.91	0.2720	69.0	109.0	6.91
A1007.0	–	7.00	0.2756	69.0	109.0	7.00
A100J	J	7.04	0.2770	69.0	109.0	7.04
A1007.1	–	7.10	0.2795	69.0	109.0	7.10
A1009/32	9/32	7.14	0.2813	69.0	109.0	7.14
A100K	K	7.14	0.2810	69.0	109.0	7.14

Producto	DC	DC	DC	LCF	OAL	DCON MS
	(inch)	(mm)	(inch)	(mm)	(mm)	(mm)
A1007.2	–	7.20	0.2835	69.0	109.0	7.20
A1007.25	–	7.25	0.2854	69.0	109.0	7.25
A1007.3	–	7.30	0.2874	69.0	109.0	7.30
A100L	L	7.37	0.2900	69.0	109.0	7.37
A1007.4	–	7.40	0.2913	69.0	109.0	7.40
A100M	M	7.49	0.2949	69.0	109.0	7.49
A1007.5	–	7.50	0.2953	69.0	109.0	7.50
A10019/64	19/64	7.54	0.2969	75.0	117.0	7.54
A1007.6	–	7.60	0.2992	75.0	117.0	7.60
A100N	N	7.67	0.3020	75.0	117.0	7.67
A1007.7	–	7.70	0.3031	75.0	117.0	7.70
A1007.75	–	7.75	0.3051	75.0	117.0	7.75
A1007.8	–	7.80	0.3071	75.0	117.0	7.80
A1007.9	–	7.90	0.3110	75.0	117.0	7.90
A1005/16	5/16	7.94	0.3125	75.0	117.0	7.94
A1008.0	–	8.00	0.3150	75.0	117.0	8.00
A100O	O	8.03	0.3160	75.0	117.0	8.03
A1008.1	–	8.10	0.3189	75.0	117.0	8.10
A1008.2	–	8.20	0.3228	75.0	117.0	8.20
A100P	P	8.20	0.3230	75.0	117.0	8.20
A1008.25	–	8.25	0.3248	75.0	117.0	8.25
A1008.3	–	8.30	0.3268	75.0	117.0	8.30
A10021/64	21/64	8.33	0.3281	75.0	117.0	8.33
A1008.4	–	8.40	0.3307	75.0	117.0	8.40
A100Q	Q	8.43	0.3320	75.0	117.0	8.43
A1008.5	–	8.50	0.3346	75.0	117.0	8.50
A1008.6	–	8.60	0.3386	81.0	125.0	8.60
A100R	R	8.61	0.3390	81.0	125.0	8.61
A1008.7	–	8.70	0.3425	81.0	125.0	8.70
A10011/32	11/32	8.73	0.3438	81.0	125.0	8.73
A1008.75	–	8.75	0.3445	81.0	125.0	8.75
A1008.8	–	8.80	0.3465	81.0	125.0	8.80
A100S	S	8.84	0.3480	81.0	125.0	8.84
A1008.9	–	8.90	0.3504	81.0	125.0	8.90
A1009.0	–	9.00	0.3543	81.0	125.0	9.00
A100T	T	9.09	0.3580	81.0	125.0	9.09
A1009.1	–	9.10	0.3583	81.0	125.0	9.10
A10023/64	23/64	9.13	0.3594	81.0	125.0	9.13
A1009.2	–	9.20	0.3622	81.0	125.0	9.20
A1009.25	–	9.25	0.3642	81.0	125.0	9.25
A1009.3	–	9.30	0.3661	81.0	125.0	9.30
A100U	U	9.35	0.3680	81.0	125.0	9.35
A1009.4	–	9.40	0.3701	81.0	125.0	9.40
A1009.5	–	9.50	0.3740	81.0	125.0	9.50
A1003/8	3/8	9.52	0.3750	87.0	133.0	9.52
A100V	V	9.58	0.3770	87.0	133.0	9.58
A1009.6	–	9.60	0.3780	87.0	133.0	9.60
A1009.7	–	9.70	0.3819	87.0	133.0	9.70
A1009.75	–	9.75	0.3839	87.0	133.0	9.75
A1009.8	–	9.80	0.3858	87.0	133.0	9.80
A100W	W	9.80	0.3860	87.0	133.0	9.80
A1009.9	–	9.90	0.3898	87.0	133.0	9.90
A10025/64	25/64	9.92	0.3906	87.0	133.0	9.92
A10010.0	–	10.00	0.3937	87.0	133.0	10.00
A100X	X	10.08	0.3970	87.0	133.0	10.08
A10010.1	–	10.10	0.3976	87.0	133.0	10.10
A10010.2	–	10.20	0.4016	87.0	133.0	10.20
A10010.25	–	10.25	0.4035	87.0	133.0	10.25
A100Y	Y	10.26	0.4040	87.0	133.0	10.26
A10010.3	–	10.30	0.4055	87.0	133.0	10.30
A10013/32	13/32	10.32	0.4063	87.0	133.0	10.32
A10010.4	–	10.40	0.4094	87.0	133.0	10.40



Producto	DC	DC	DC	LCF	OAL	DCON MS
	(inch)	(mm)	(inch)	(mm)	(mm)	(mm)
A100Z	Z	10.49	0.4130	87.0	133.0	10.49
A10010.5	–	10.50	0.4134	87.0	133.0	10.50
A10010.6	–	10.60	0.4173	87.0	133.0	10.60
A10010.7	–	10.70	0.4213	94.0	142.0	10.70
A10027/64	27/64	10.72	0.4219	94.0	142.0	10.72
A10010.75	–	10.75	0.4232	94.0	142.0	10.75
A10010.8	–	10.80	0.4252	94.0	142.0	10.80
A10010.9	–	10.90	0.4291	94.0	142.0	10.90
A10011.0	–	11.00	0.4331	94.0	142.0	11.00
A10011.1	–	11.10	0.4370	94.0	142.0	11.10
A1007/16	7/16	11.11	0.4375	94.0	142.0	11.11
A10011.2	–	11.20	0.4409	94.0	142.0	11.20
A10011.25	–	11.25	0.4429	94.0	142.0	11.25
A10011.3	–	11.30	0.4449	94.0	142.0	11.30
A10011.4	–	11.40	0.4488	94.0	142.0	11.40
A10011.5	–	11.50	0.4528	94.0	142.0	11.50
A10029/64	29/64	11.51	0.4531	94.0	142.0	11.51
A10011.6	–	11.60	0.4567	94.0	142.0	11.60
A10011.7	–	11.70	0.4606	94.0	142.0	11.70
A10011.75	–	11.75	0.4626	94.0	142.0	11.75
A10011.8	–	11.80	0.4646	94.0	142.0	11.80
A10011.9	–	11.90	0.4685	101.0	151.0	11.90
A10015/32	15/32	11.91	0.4688	101.0	151.0	11.91
A10012.0	–	12.00	0.4724	101.0	151.0	12.00
A10012.1	–	12.10	0.4764	101.0	151.0	12.10
A10012.2	–	12.20	0.4803	101.0	151.0	12.20
A10012.25	–	12.25	0.4823	101.0	151.0	12.25
A10012.3	–	12.30	0.4843	101.0	151.0	12.30
A10031/64	31/64	12.30	0.4844	101.0	151.0	12.30
A10012.4	–	12.40	0.4882	101.0	151.0	12.40
A10012.5	–	12.50	0.4921	101.0	151.0	12.50
A10012.6	–	12.60	0.4961	101.0	151.0	12.60
A10012.7	–	12.70	0.5000	101.0	151.0	12.70
A1001/2	1/2	12.70	0.5000	101.0	151.0	12.70
A10012.75	–	12.75	0.5020	101.0	151.0	12.75
A10012.8	–	12.80	0.5039	101.0	151.0	12.80
A10012.9	–	12.90	0.5079	101.0	151.0	12.90
A10013.0	–	13.00	0.5118	101.0	151.0	13.00
A10033/64	33/64	13.10	0.5156	101.0	151.0	13.10

Producto	DC	DC	DC	LCF	OAL	DCON MS
	(inch)	(mm)	(inch)	(mm)	(mm)	(mm)
A10013.1	–	13.10	0.5157	101.0	151.0	13.10
A10013.2	–	13.20	0.5197	101.0	151.0	13.20
A10013.25	–	13.25	0.5217	108.0	160.0	13.25
A10013.3	–	13.30	0.5236	108.0	160.0	13.30
A10013.4	–	13.40	0.5276	108.0	160.0	13.40
A10017/32	17/32	13.49	0.5313	108.0	160.0	13.49
A10013.5	–	13.50	0.5315	108.0	160.0	13.50
A10013.6	–	13.60	0.5354	108.0	160.0	13.60
A10013.7	–	13.70	0.5394	108.0	160.0	13.70
A10013.75	–	13.75	0.5413	108.0	160.0	13.75
A10013.8	–	13.80	0.5433	108.0	160.0	13.80
A10035/64	35/64	13.89	0.5469	108.0	160.0	13.89
A10013.9	–	13.90	0.5472	108.0	160.0	13.90
A10014.0	–	14.00	0.5512	108.0	160.0	14.00
A10014.25	–	14.25	0.5610	114.0	169.0	14.25
A1009/16	9/16	14.29	0.5625	114.0	169.0	14.29
A10014.5	–	14.50	0.5709	114.0	169.0	14.50
A10037/64	37/64	14.68	0.5781	114.0	169.0	14.68
A10014.75	–	14.75	0.5807	114.0	169.0	14.75
A10015.0	–	15.00	0.5906	114.0	169.0	15.00
A10019/32	19/32	15.08	0.5938	120.0	178.0	15.08
A10015.25	–	15.25	0.6004	120.0	178.0	15.25
A10039/64	39/64	15.48	0.6094	120.0	178.0	15.48
A10015.5	–	15.50	0.6102	120.0	178.0	15.50
A10015.75	–	15.75	0.6201	120.0	178.0	15.75
A1005/8	5/8	15.88	0.6250	120.0	178.0	15.88
A10016.0	–	16.00	0.6299	120.0	178.0	16.00
A10041/64	41/64	16.27	0.6406	125.0	184.0	16.27
A10016.5	–	16.50	0.6496	125.0	184.0	16.50
A10021/32	21/32	16.67	0.6563	125.0	184.0	16.67
A10017.0	–	17.00	0.6693	125.0	184.0	17.00
A10043/64	43/64	17.07	0.6719	130.0	191.0	17.07
A10011/16	11/16	17.46	0.6875	130.0	191.0	17.46
A10017.5	–	17.50	0.6890	130.0	191.0	17.50
A10018.0	–	18.00	0.7087	130.0	191.0	18.00
A10018.5	–	18.50	0.7283	135.0	198.0	18.50
A10019.0	–	19.00	0.7480	135.0	198.0	19.00
A10019.5	–	19.50	0.7677	140.0	205.0	19.50
A10020.0	–	20.00	0.7874	140.0	205.0	20.00



A101



Broca HSS Serie Corta, a Izquierda, Acabado Templado al Vapor

Broca versátil a izquierda con acabado templado al vapor para taladrado manual y en máquina. La punta convencional a 118° proporciona resistencia y facilita el reafilado, haciéndola más rentable. El acabado templado al vapor retiene el fluido de corte y evita la soldadura de la viruta a la herramienta. Apta para taladrar muchos materiales.

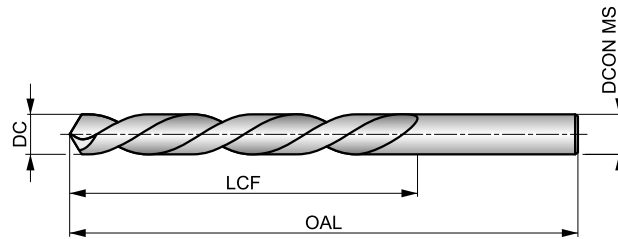

HSS	DIN 338	4xD
118°	ST	
20-35°	L	DC h8

Grupo de Material de la pieza adecuado y condiciones de velocidad de corte iniciales (m/min) y código de avance alfabético. Tablas con avance por revolución a partir de la pag.175.

P1.1 ■ 33 H	P1.2 ■ 37 H	P1.3 ■ 38 H	P2.1 ■ 28 H	P2.2 ■ 25 F	P2.3 ■ 22 E	P3.1 ■ 19 F	P3.2 ■ 15 F	P3.3 ■ 13 E	P4.1 ■ 11 F	P4.2 ■ 10 E	P4.3 ■ 8 D	M1.1 ■ 21 E	M1.2 ■ 17 E
M2.1 ■ 18 E	M2.2 ■ 15 E	M3.1 ■ 9 G	M3.2 ■ 8 G	M3.3 ■ 7 G	M4.1 ■ 9 C	K1.1 ■ 30 H	K1.2 ■ 22 F	K1.3 ■ 17 F	K2.1 ■ 25 E	K2.2 ■ 20 E	K2.3 ■ 16 E	K3.1 ■ 22 E	K3.2 ■ 17 E
K3.3 ■ 13 E	K4.1 ■ 20 E	K4.2 ■ 15 E	K4.3 ■ 11 E	K4.4 ■ 10 E	K4.5 ■ 8 E	K5.1 ■ 23 E	K5.2 ■ 17 E	K5.3 ■ 13 E	N1.1 ■ 33 J	N1.2 ■ 25 J	N1.3 ■ 17 I	N2.1 ■ 42 H	N2.2 ■ 37 H
N2.3 ■ 27 H	N3.1 ■ 59 H	N3.2 ■ 35 I	N3.3 ■ 18 G	N4.1 ■ 30 J	N4.2 ■ 28 H	N4.3 ■ 14 F	S1.1 ■ 23 E	S1.2 ■ 12 D	S1.3 ■ 6 B	S2.1 ■ 8 E	S2.2 ■ 4 A	S3.1 ■ 6 E	S3.2 ■ 3 A
S4.1 ■ 5 E	S4.2 ■ 2 A												

DC <= 3mm Brillante

Producto	DC (mm)	DC (inch)	LCF (mm)	OAL (mm)	DCON MS (mm)	Producto	DC (mm)	DC (inch)	LCF (mm)	OAL (mm)	DCON MS (mm)
A1011.0	1.00	0.0394	12.0	34.0	1.00	A1013.2	3.20	0.1260	36.0	65.0	3.20
A1011.1	1.10	0.0433	14.0	36.0	1.10	A1013.3	3.30	0.1299	36.0	65.0	3.30
A1011.2	1.20	0.0472	16.0	38.0	1.20	A1013.5	3.50	0.1378	39.0	70.0	3.50
A1011.25	1.25	0.0492	16.0	38.0	1.25	A1013.8	3.80	0.1496	43.0	75.0	3.80
A1011.3	1.30	0.0512	16.0	38.0	1.30	A1014.0	4.00	0.1575	43.0	75.0	4.00
A1011.4	1.40	0.0551	18.0	40.0	1.40	A1014.2	4.20	0.1654	43.0	75.0	4.20
A1011.5	1.50	0.0591	18.0	40.0	1.50	A1014.5	4.50	0.1772	47.0	80.0	4.50
A1011.6	1.60	0.0630	20.0	43.0	1.60	A1014.8	4.80	0.1890	52.0	86.0	4.80
A1011.7	1.70	0.0669	20.0	43.0	1.70	A1015.0	5.00	0.1969	52.0	86.0	5.00
A1011.8	1.80	0.0709	22.0	46.0	1.80	A1015.1	5.10	0.2008	52.0	86.0	5.10
A1011.9	1.90	0.0748	22.0	46.0	1.90	A1015.2	5.20	0.2047	52.0	86.0	5.20
A1012.0	2.00	0.0787	24.0	49.0	2.00	A1015.5	5.50	0.2165	57.0	93.0	5.50
A1012.1	2.10	0.0827	24.0	49.0	2.10	A1016.0	6.00	0.2362	57.0	93.0	6.00
A1012.2	2.20	0.0866	27.0	53.0	2.20	A1016.5	6.50	0.2559	63.0	101.0	6.50
A1012.3	2.30	0.0906	27.0	53.0	2.30	A1017.0	7.00	0.2756	69.0	109.0	7.00
A1012.4	2.40	0.0945	30.0	57.0	2.40	A1017.5	7.50	0.2953	69.0	109.0	7.50
A1012.5	2.50	0.0984	30.0	57.0	2.50	A1018.0	8.00	0.3150	75.0	117.0	8.00
A1012.6	2.60	0.1024	30.0	57.0	2.60	A1018.5	8.50	0.3346	75.0	117.0	8.50
A1012.7	2.70	0.1063	33.0	61.0	2.70	A1019.0	9.00	0.3543	81.0	125.0	9.00
A1012.8	2.80	0.1102	33.0	61.0	2.80	A10110.0	10.00	0.3937	87.0	133.0	10.00
A1012.9	2.90	0.1142	33.0	61.0	2.90	A10111.0	11.00	0.4331	94.0	142.0	11.00
A1013.0	3.00	0.1181	33.0	61.0	3.00	A10112.0	12.00	0.4724	101.0	151.0	12.00



A108



Broca HSS, Serie Corta, Acabado Templado al Vapor (Diseñada para Acero Inoxidable)

Primera elección para taladrar acero inoxidable en aplicaciones manuales, aunque también se puede utilizar eficazmente en máquinas. La punta dividida a 135° mejora el autocentrado y reduce las fuerzas de corte. El acabado templado al vapor ayuda a evitar que el material de la pieza se adhiera al filo.

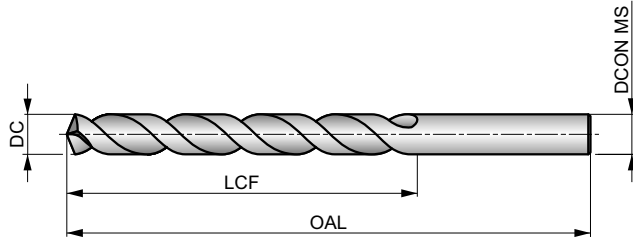

HSS	DIN 338	4xD
135°	ST	
λ > 35°	R	DC h8

Grupo de Material de la pieza adecuado y condiciones de velocidad de corte iniciales (m/min) y código de avance alfabético. Tablas con avance por revolución a partir de la pag.175.

P1.1 33 I	P1.2 37 I	P1.3 38 I	P2.1 28 I	P2.2 25 G	P2.3 22 E	P3.1 19 F	P3.2 15 F	P3.3 13 E	P4.1 11 F	P4.2 10 E	P4.3 8 D	M1.1 21 E	M1.2 17 E
M2.1 18 E	M2.2 15 E	M3.1 10 G	M3.2 9 G	M3.3 8 G	M4.1 10 D	K1.1 30 H	K1.2 22 F	K1.3 17 F	K2.1 25 E	K2.2 20 E	K2.3 16 E	K3.1 22 E	K3.2 17 E
K3.3 13 E	K4.1 20 E	K4.2 15 E	K4.3 11 E	K4.4 10 E	K4.5 8 E	K5.1 23 E	K5.2 17 E	K5.3 13 E	N1.1 33 J	N1.2 25 J	N1.3 17 I	N2.1 42 H	N2.2 37 H
N2.3 27 H	N3.1 59 H	N3.2 35 I	N3.3 18 G	N4.1 30 J	N4.2 28 H	N4.3 14 F	S1.1 25 G	S1.2 16 E	S1.3 7 B	S2.1 9 G	S2.2 8 E	S3.1 7 G	S3.2 6 E
S4.1 5 G	S4.2 5 E												

DC > 1.5mm (1/16") Afilado en Cruz

Los productos de esta serie también están disponibles en forma de Set. Por favor, vea A188.

Producto	DC (inch)	DC (mm)	DC (inch)	LCF (mm)	OAL (mm)	DC ON MS (mm)
A1081.0	-	1.00	0.0394	12.0	34.0	1.00
A1081.1	-	1.10	0.0433	14.0	36.0	1.10
A1081.2	-	1.20	0.0472	16.0	38.0	1.20
A1081.3	-	1.30	0.0512	16.0	38.0	1.30
A1081.4	-	1.40	0.0551	18.0	40.0	1.40
A1081.5	-	1.50	0.0591	18.0	40.0	1.50
A1081/16	1/16	1.59	0.0625	20.0	43.0	1.59
A1081.6	-	1.60	0.0630	20.0	43.0	1.60
A1081.7	-	1.70	0.0669	20.0	43.0	1.70
A1081.8	-	1.80	0.0709	22.0	46.0	1.80
A1081.9	-	1.90	0.0748	22.0	46.0	1.90
A1085/64	5/64	1.98	0.0781	24.0	49.0	1.98
A1082.0	-	2.00	0.0787	24.0	49.0	2.00
A1082.1	-	2.10	0.0827	24.0	49.0	2.10
A1082.2	-	2.20	0.0866	27.0	53.0	2.20
A1082.3	-	2.30	0.0906	27.0	53.0	2.30
A1083/32	3/32	2.38	0.0938	30.0	57.0	2.38
A1082.4	-	2.40	0.0945	30.0	57.0	2.40
A1082.5	-	2.50	0.0984	30.0	57.0	2.50
A1082.6	-	2.60	0.1024	30.0	57.0	2.60
A1082.7	-	2.70	0.1063	33.0	61.0	2.70
A1087/64	7/64	2.78	0.1094	33.0	61.0	2.78

Producto	DC (inch)	DC (mm)	DC (inch)	LCF (mm)	OAL (mm)	DC ON MS (mm)
A1082.8	-	2.80	0.1102	33.0	61.0	2.80
A1082.9	-	2.90	0.1142	33.0	61.0	2.90
A1083.0	-	3.00	0.1181	33.0	61.0	3.00
A1083.1	-	3.10	0.1220	36.0	65.0	3.10
A1081/8	1/8	3.18	0.1250	36.0	65.0	3.18
A1083.2	-	3.20	0.1260	36.0	65.0	3.20
A1083.3	-	3.30	0.1299	36.0	65.0	3.30
A1083.4	-	3.40	0.1339	39.0	70.0	3.40
A1083.5	-	3.50	0.1378	39.0	70.0	3.50
A1089/64	9/64	3.57	0.1406	39.0	70.0	3.57
A1083.6	-	3.60	0.1417	39.0	70.0	3.60
A1083.7	-	3.70	0.1457	39.0	70.0	3.70
A1083.8	-	3.80	0.1496	43.0	75.0	3.80
A1083.9	-	3.90	0.1535	43.0	75.0	3.90
A1085/32	5/32	3.97	0.1563	43.0	75.0	3.97
A1084.0	-	4.00	0.1575	43.0	75.0	4.00
A1084.1	-	4.10	0.1614	43.0	75.0	4.10
A1084.2	-	4.20	0.1654	43.0	75.0	4.20
A1084.3	-	4.30	0.1693	47.0	80.0	4.30
A10811/64	11/64	4.37	0.1719	47.0	80.0	4.37
A1084.4	-	4.40	0.1732	47.0	80.0	4.40
A1084.5	-	4.50	0.1772	47.0	80.0	4.50



Producto	DC	DC	DC	LCF	OAL	DCON MS
	(inch)	(mm)	(inch)	(mm)	(mm)	(mm)
A1084.6	–	4.60	0.1811	47.0	80.0	4.60
A1084.7	–	4.70	0.1850	47.0	80.0	4.70
A1083/16	3/16	4.76	0.1875	52.0	86.0	4.76
A1084.8	–	4.80	0.1890	52.0	86.0	4.80
A1084.9	–	4.90	0.1929	52.0	86.0	4.90
A108N10	N10	4.92	0.1935	52.0	86.0	4.92
A1085.0	–	5.00	0.1969	52.0	86.0	5.00
A1085.1	–	5.10	0.2008	52.0	86.0	5.10
A10813/64	13/64	5.16	0.2031	52.0	86.0	5.16
A1085.2	–	5.20	0.2047	52.0	86.0	5.20
A1085.3	–	5.30	0.2087	52.0	86.0	5.30
A1085.4	–	5.40	0.2126	57.0	93.0	5.40
A1085.5	–	5.50	0.2165	57.0	93.0	5.50
A1087/32	7/32	5.56	0.2188	57.0	93.0	5.56
A1085.6	–	5.60	0.2205	57.0	93.0	5.60
A1085.7	–	5.70	0.2244	57.0	93.0	5.70
A1085.8	–	5.80	0.2283	57.0	93.0	5.80
A1085.9	–	5.90	0.2323	57.0	93.0	5.90
A10815/64	15/64	5.95	0.2344	57.0	93.0	5.95
A1086.0	–	6.00	0.2362	57.0	93.0	6.00
A1086.1	–	6.10	0.2402	63.0	101.0	6.10
A1086.2	–	6.20	0.2441	63.0	101.0	6.20
A1086.3	–	6.30	0.2480	63.0	101.0	6.30
A1081/4	1/4	6.35	0.2500	63.0	101.0	6.35
A1086.4	–	6.40	0.2520	63.0	101.0	6.40
A1086.5	–	6.50	0.2559	63.0	101.0	6.50
A1086.6	–	6.60	0.2598	63.0	101.0	6.60
A1086.7	–	6.70	0.2638	63.0	101.0	6.70
A10817/64	17/64	6.75	0.2656	69.0	109.0	6.75
A1086.8	–	6.80	0.2677	69.0	109.0	6.80
A1086.9	–	6.90	0.2717	69.0	109.0	6.90
A1087.0	–	7.00	0.2756	69.0	109.0	7.00
A1087.1	–	7.10	0.2795	69.0	109.0	7.10
A1089/32	9/32	7.14	0.2813	69.0	109.0	7.14
A1087.2	–	7.20	0.2835	69.0	109.0	7.20
A1087.3	–	7.30	0.2874	69.0	109.0	7.30
A1087.4	–	7.40	0.2913	69.0	109.0	7.40
A1087.5	–	7.50	0.2953	69.0	109.0	7.50
A10819/64	19/64	7.54	0.2969	75.0	117.0	7.54
A1087.6	–	7.60	0.2992	75.0	117.0	7.60
A1087.7	–	7.70	0.3031	75.0	117.0	7.70
A1087.8	–	7.80	0.3071	75.0	117.0	7.80
A1087.9	–	7.90	0.3110	75.0	117.0	7.90
A1085/16	5/16	7.94	0.3125	75.0	117.0	7.94
A1088.0	–	8.00	0.3150	75.0	117.0	8.00
A1088.1	–	8.10	0.3189	75.0	117.0	8.10
A1088.2	–	8.20	0.3228	75.0	117.0	8.20
A1088.3	–	8.30	0.3268	75.0	117.0	8.30

Producto	DC	DC	DC	LCF	OAL	DCON MS
	(inch)	(mm)	(inch)	(mm)	(mm)	(mm)
A10821/64	21/64	8.33	0.3281	75.0	117.0	8.33
A1088.4	–	8.40	0.3307	75.0	117.0	8.40
A1088.5	–	8.50	0.3346	75.0	117.0	8.50
A1088.6	–	8.60	0.3386	81.0	125.0	8.60
A1088.7	–	8.70	0.3425	81.0	125.0	8.70
A10811/32	11/32	8.73	0.3438	81.0	125.0	8.73
A1088.8	–	8.80	0.3465	81.0	125.0	8.80
A1088.9	–	8.90	0.3504	81.0	125.0	8.90
A1089.0	–	9.00	0.3543	81.0	125.0	9.00
A1089.1	–	9.10	0.3583	81.0	125.0	9.10
A10823/64	23/64	9.13	0.3594	81.0	125.0	9.13
A1089.2	–	9.20	0.3622	81.0	125.0	9.20
A1089.3	–	9.30	0.3661	81.0	125.0	9.30
A1089.4	–	9.40	0.3701	81.0	125.0	9.40
A1089.5	–	9.50	0.3740	81.0	125.0	9.50
A1083/8	3/8	9.52	0.3750	87.0	133.0	9.52
A1089.6	–	9.60	0.3780	87.0	133.0	9.60
A1089.7	–	9.70	0.3819	87.0	133.0	9.70
A1089.8	–	9.80	0.3858	87.0	133.0	9.80
A1089.9	–	9.90	0.3898	87.0	133.0	9.90
A10825/64	25/64	9.92	0.3906	87.0	133.0	9.92
A10810.0	–	10.00	0.3937	87.0	133.0	10.00
A10810.2	–	10.20	0.4016	87.0	133.0	10.20
A10813/32	13/32	10.32	0.4063	87.0	133.0	10.32
A10810.5	–	10.50	0.4134	87.0	133.0	10.50
A10827/64	27/64	10.72	0.4219	94.0	142.0	10.72
A10810.8	–	10.80	0.4252	94.0	142.0	10.80
A10811.0	–	11.00	0.4331	94.0	142.0	11.00
A1087/16	7/16	11.11	0.4375	94.0	142.0	11.11
A10811.5	–	11.50	0.4528	94.0	142.0	11.50
A10829/64	29/64	11.51	0.4531	94.0	142.0	11.51
A10811.8	–	11.80	0.4646	94.0	142.0	11.80
A10815/32	15/32	11.91	0.4688	101.0	151.0	11.91
A10812.0	–	12.00	0.4724	101.0	151.0	12.00
A10812.2	–	12.20	0.4803	101.0	151.0	12.20
A10831/64	31/64	12.30	0.4844	101.0	151.0	12.30
A10812.5	–	12.50	0.4921	101.0	151.0	12.50
A1081/2	1/2	12.70	0.5000	101.0	151.0	12.70
A10812.8	–	12.80	0.5039	101.0	151.0	12.80
A10812.9	–	12.90	0.5079	101.0	151.0	12.90
A10813.0	–	13.00	0.5118	101.0	151.0	13.00
A10813.5	–	13.50	0.5315	108.0	160.0	13.50
A10814.0	–	14.00	0.5512	108.0	160.0	14.00
A10814.5	–	14.50	0.5709	114.0	169.0	14.50
A10815.0	–	15.00	0.5906	114.0	169.0	15.00
A10815.25	–	15.25	0.6004	120.0	178.0	15.25
A10815.5	–	15.50	0.6102	120.0	178.0	15.50
A10816.0	–	16.00	0.6299	120.0	178.0	16.00



A147



Broca HSS-E (5% Cobalto), Serie Corta, Acabado Brillante (Diseñada Para Acero Inoxidable)

Broca versátil y resistente que satisface todos los requisitos de taladrado en máquina en aceros inoxidables, aunque también se puede utilizar para operaciones manuales. La punta dividida a 130° mejora el auto-centrado y reduce las fuerzas de corte. Acabado brillante.

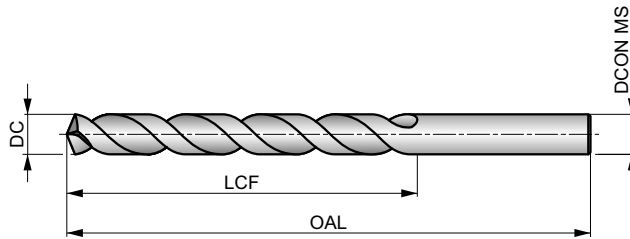

HSS-E	DIN 338	4xD
130°	Bright	
VA	R	DC h8

Grupo de Material de la pieza adecuado y condiciones de velocidad de corte iniciales (m/min) y código de avance alfabético. Tablas con avance por revolución a partir de la pag.175.

P1.1 33 I	P1.2 37 I	P1.3 38 I	P2.1 28 I	P2.2 25 G	P2.3 22 E	P3.1 19 F	P3.2 15 F	P3.3 13 E	P4.1 11 F	P4.2 10 E	P4.3 8 D	M1.1 21 E	M1.2 17 E
M2.1 18 E	M2.2 15 E	M2.3 13 B	M3.1 10 G	M3.2 9 G	M3.3 8 G	M4.1 10 D	M4.2 9 B	K1.1 30 H	K1.2 22 F	K1.3 17 F	K2.1 25 E	K2.2 20 E	K2.3 16 E
K3.1 22 E	K3.2 17 E	K3.3 13 E	K4.1 20 E	K4.2 15 E	K4.3 11 E	K4.4 10 E	K4.5 8 E	K5.1 23 E	K5.2 17 E	K5.3 13 E	N1.1 33 J	N1.2 25 J	N1.3 17 I
N2.1 42 H	N2.2 37 H	N2.3 27 H	N3.1 59 H	N3.2 35 I	N3.3 18 G	N4.1 30 J	N4.2 28 H	N4.3 14 F	S1.1 25 G	S1.2 16 E	S1.3 7 B	S2.1 9 G	S2.2 8 E
S3.1 7 G	S3.2 6 E	S4.1 5 G	S4.2 5 E										

Producto	DC (inch)	DC (mm)	DC (inch)	LCF (mm)	OAL (mm)	DCON MS (mm)
A147.3	-	0.30	0.0118	3.0	19.0	0.30
A147.4	-	0.40	0.0157	5.0	20.0	0.40
A147.5	-	0.50	0.0197	6.0	22.0	0.50
A147.6	-	0.60	0.0236	7.0	24.0	0.60
A147.7	-	0.70	0.0276	9.0	28.0	0.70
A147.8	-	0.80	0.0315	10.0	30.0	0.80
A147.9	-	0.90	0.0354	11.0	32.0	0.90
A1471.0	-	1.00	0.0394	12.0	34.0	1.00
A1471.1	-	1.10	0.0433	14.0	36.0	1.10
A1471.2	-	1.20	0.0472	16.0	38.0	1.20
A1471.3	-	1.30	0.0512	16.0	38.0	1.30
A1471.4	-	1.40	0.0551	18.0	40.0	1.40
A1471.5	-	1.50	0.0591	18.0	40.0	1.50
A1471/16	1/16	1.59	0.0625	20.0	43.0	1.59
A1471.6	-	1.60	0.0630	20.0	43.0	1.60
A1471.7	-	1.70	0.0669	20.0	43.0	1.70
A1471.8	-	1.80	0.0709	22.0	46.0	1.80
A1471.9	-	1.90	0.0748	22.0	46.0	1.90
A1472.0	-	2.00	0.0787	24.0	49.0	2.00
A1472.1	-	2.10	0.0827	24.0	49.0	2.10
A1472.2	-	2.20	0.0866	27.0	53.0	2.20
A1472.3	-	2.30	0.0906	27.0	53.0	2.30
A1473/32	3/32	2.38	0.0938	30.0	57.0	2.38
A1472.4	-	2.40	0.0945	30.0	57.0	2.40

Producto	DC (inch)	DC (mm)	DC (inch)	LCF (mm)	OAL (mm)	DCON MS (mm)
A1472.5	-	2.50	0.0984	30.0	57.0	2.50
A1472.6	-	2.60	0.1024	30.0	57.0	2.60
A1472.7	-	2.70	0.1063	33.0	61.0	2.70
A1472.8	-	2.80	0.1102	33.0	61.0	2.80
A1472.9	-	2.90	0.1142	33.0	61.0	2.90
A1473.0	-	3.00	0.1181	33.0	61.0	3.00
A1473.1	-	3.10	0.1220	36.0	65.0	3.10
A1471/8	1/8	3.18	0.1250	36.0	65.0	3.18
A1473.2	-	3.20	0.1260	36.0	65.0	3.20
A1473.3	-	3.30	0.1299	36.0	65.0	3.30
A1473.4	-	3.40	0.1339	39.0	70.0	3.40
A1473.5	-	3.50	0.1378	39.0	70.0	3.50
A1473.6	-	3.60	0.1417	39.0	70.0	3.60
A1473.7	-	3.70	0.1457	39.0	70.0	3.70
A1473.8	-	3.80	0.1496	43.0	75.0	3.80
A1473.9	-	3.90	0.1535	43.0	75.0	3.90
A1475/32	5/32	3.97	0.1563	43.0	75.0	3.97
A1474.0	-	4.00	0.1575	43.0	75.0	4.00
A1474.1	-	4.10	0.1614	43.0	75.0	4.10
A1474.2	-	4.20	0.1654	43.0	75.0	4.20
A1474.3	-	4.30	0.1693	47.0	80.0	4.30
A1474.4	-	4.40	0.1732	47.0	80.0	4.40
A1474.5	-	4.50	0.1772	47.0	80.0	4.50
A1474.6	-	4.60	0.1811	47.0	80.0	4.60



Producto	DC	DC	DC	LCF	OAL	DCON MS
	(inch)	(mm)	(inch)	(mm)	(mm)	(mm)
A1474.7	–	4.70	0.1850	47.0	80.0	4.70
A1473/16	3/16	4.76	0.1875	52.0	86.0	4.76
A1474.8	–	4.80	0.1890	52.0	86.0	4.80
A1474.9	–	4.90	0.1929	52.0	86.0	4.90
A1475.0	–	5.00	0.1969	52.0	86.0	5.00
A1475.1	–	5.10	0.2008	52.0	86.0	5.10
A1475.2	–	5.20	0.2047	52.0	86.0	5.20
A1475.3	–	5.30	0.2087	52.0	86.0	5.30
A1475.4	–	5.40	0.2126	57.0	93.0	5.40
A1475.5	–	5.50	0.2165	57.0	93.0	5.50
A1475.6	–	5.60	0.2205	57.0	93.0	5.60
A1475.7	–	5.70	0.2244	57.0	93.0	5.70
A1475.8	–	5.80	0.2283	57.0	93.0	5.80
A1475.9	–	5.90	0.2323	57.0	93.0	5.90
A1476.0	–	6.00	0.2362	57.0	93.0	6.00
A1476.1	–	6.10	0.2402	63.0	101.0	6.10
A1476.2	–	6.20	0.2441	63.0	101.0	6.20
A1476.3	–	6.30	0.2480	63.0	101.0	6.30
A1471/4	1/4	6.35	0.2500	63.0	101.0	6.35
A1476.4	–	6.40	0.2520	63.0	101.0	6.40
A1476.5	–	6.50	0.2559	63.0	101.0	6.50
A1476.6	–	6.60	0.2598	63.0	101.0	6.60
A1476.7	–	6.70	0.2638	63.0	101.0	6.70
A1476.8	–	6.80	0.2677	69.0	109.0	6.80
A1476.9	–	6.90	0.2717	69.0	109.0	6.90
A1477.0	–	7.00	0.2756	69.0	109.0	7.00
A1477.1	–	7.10	0.2795	69.0	109.0	7.10
A1477.2	–	7.20	0.2835	69.0	109.0	7.20
A1477.3	–	7.30	0.2874	69.0	109.0	7.30
A1477.4	–	7.40	0.2913	69.0	109.0	7.40
A1477.5	–	7.50	0.2953	69.0	109.0	7.50
A1477.6	–	7.60	0.2992	75.0	117.0	7.60
A1477.7	–	7.70	0.3031	75.0	117.0	7.70
A1477.8	–	7.80	0.3071	75.0	117.0	7.80

Producto	DC	DC	DC	LCF	OAL	DCON MS
	(inch)	(mm)	(inch)	(mm)	(mm)	(mm)
A1477.9	–	7.90	0.3110	75.0	117.0	7.90
A1478.0	–	8.00	0.3150	75.0	117.0	8.00
A1478.1	–	8.10	0.3189	75.0	117.0	8.10
A1478.2	–	8.20	0.3228	75.0	117.0	8.20
A1478.3	–	8.30	0.3268	75.0	117.0	8.30
A1478.4	–	8.40	0.3307	75.0	117.0	8.40
A1478.5	–	8.50	0.3346	75.0	117.0	8.50
A1478.6	–	8.60	0.3386	81.0	125.0	8.60
A1478.7	–	8.70	0.3425	81.0	125.0	8.70
A1478.8	–	8.80	0.3465	81.0	125.0	8.80
A1478.9	–	8.90	0.3504	81.0	125.0	8.90
A1479.0	–	9.00	0.3543	81.0	125.0	9.00
A1479.1	–	9.10	0.3583	81.0	125.0	9.10
A1479.2	–	9.20	0.3622	81.0	125.0	9.20
A1479.3	–	9.30	0.3661	81.0	125.0	9.30
A1479.4	–	9.40	0.3701	81.0	125.0	9.40
A1479.5	–	9.50	0.3740	81.0	125.0	9.50
A1479.6	–	9.60	0.3780	87.0	133.0	9.60
A1479.7	–	9.70	0.3819	87.0	133.0	9.70
A1479.8	–	9.80	0.3858	87.0	133.0	9.80
A1479.9	–	9.90	0.3898	87.0	133.0	9.90
A14710.0	–	10.00	0.3937	87.0	133.0	10.00
A14710.2	–	10.20	0.4016	87.0	133.0	10.20
A14710.5	–	10.50	0.4134	87.0	133.0	10.50
A14711.0	–	11.00	0.4331	94.0	142.0	11.00
A14711.2	–	11.20	0.4409	94.0	142.0	11.20
A14711.5	–	11.50	0.4528	94.0	142.0	11.50
A14712.0	–	12.00	0.4724	101.0	151.0	12.00
A14712.5	–	12.50	0.4921	101.0	151.0	12.50
A14713.0	–	13.00	0.5118	101.0	151.0	13.00
A14713.5	–	13.50	0.5315	108.0	160.0	13.50
A14714.0	–	14.00	0.5512	108.0	160.0	14.00
A14714.5	–	14.50	0.5709	114.0	169.0	14.50
A14715.0	–	15.00	0.5906	114.0	169.0	15.00



A777



Broca HSS-E (8% Cobalto), Serie Corta, Acabado Bronce Templado

Broca de rendimiento superior, que produce agujeros de tamaño preciso con un acabado de calidad en materiales de alta resistencia. Punta dividida a 135° para facilitar el autocentrado. El acabado bronce consiste en una fina capa de óxido y es indicativo de broca de HSS-E con 8% de cobalto.

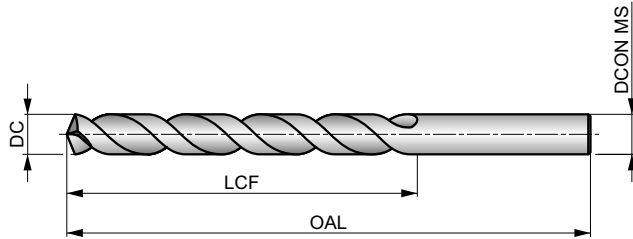

HSS-E	DIN 338	4xD
135°	Bronze	
λ 20-35°	R	DC h8

Grupo de Material de la pieza adecuado y condiciones de velocidad de corte iniciales (m/min) y código de avance alfabético. Tablas con avance por revolución a partir de la pag.175.

P1.1 36 H	P1.2 40 H	P1.3 41 H	P2.1 31 H	P2.2 27 G	P2.3 24 E	P3.1 25 F	P3.2 20 F	P3.3 17 E	P4.1 15 F	P4.2 13 E	P4.3 10 D	M1.1 30 E	M1.2 26 E
M2.1 27 E	M2.2 22 E	M3.1 13 G	M3.2 11 G	M3.3 10 G	M4.1 15 C	K1.1 35 H	K1.2 26 D	K1.3 19 D	K2.1 27 E	K2.2 22 E	K2.3 18 E	K3.1 24 E	K3.2 18 E
K3.3 15 E	K4.1 22 E	K4.2 17 E	K4.3 12 E	K4.4 11 E	K4.5 9 E	K5.1 25 E	K5.2 19 E	K5.3 15 E	N1.1 33 J	N1.2 25 J	N1.3 17 I	N2.1 46 H	N2.2 42 H
N2.3 30 H	N3.1 68 H	N3.2 40 F	N3.3 20 H	S1.1 28 F	S1.2 20 D	S1.3 11 C	S2.1 9 E	S2.2 8 B	S3.1 7 E	S3.2 6 B	S4.1 5 E	S4.2 5 B	

NAS907J. DC <= 1.4mm Punta de 4 caras

Los productos de esta serie también están disponibles en forma de Set. Por favor, vea A295.

Producto	DC (inch)	DC (mm)	DC (inch)	LCF (mm)	OAL (mm)	DCON MS (mm)
A777.3	-	0.30	0.0118	3.0	19.0	0.30
A777.35	-	0.35	0.0138	4.0	19.0	0.35
A777.4	-	0.40	0.0157	5.0	20.0	0.40
A777.45	-	0.45	0.0177	5.0	20.0	0.45
A777.5	-	0.50	0.0197	6.0	22.0	0.50
A777.55	-	0.55	0.0217	7.0	24.0	0.55
A777.6	-	0.60	0.0236	7.0	24.0	0.60
A777.65	-	0.65	0.0256	8.0	26.0	0.65
A777.7	-	0.70	0.0276	9.0	28.0	0.70
A777.8	-	0.80	0.0315	10.0	30.0	0.80
A777.9	-	0.90	0.0354	11.0	32.0	0.90
A777.95	-	0.95	0.0374	11.0	32.0	0.95
A7771.0	-	1.00	0.0394	12.0	34.0	1.00
A7771.1	-	1.10	0.0433	14.0	36.0	1.10
A7771.2	-	1.20	0.0472	16.0	38.0	1.20
A7771.3	-	1.30	0.0512	16.0	38.0	1.30
A7771.4	-	1.40	0.0551	18.0	40.0	1.40
A7771.5	-	1.50	0.0591	18.0	40.0	1.50
A7771/16	1/16	1.59	0.0625	20.0	43.0	1.59
A7771.6	-	1.60	0.0630	20.0	43.0	1.60
A7771.7	-	1.70	0.0669	20.0	43.0	1.70
A7771.8	-	1.80	0.0709	22.0	46.0	1.80
A7771.9	-	1.90	0.0748	22.0	46.0	1.90
A7775/64	5/64	1.98	0.0781	24.0	49.0	1.98

Producto	DC (inch)	DC (mm)	DC (inch)	LCF (mm)	OAL (mm)	DCON MS (mm)
A7772.0	-	2.00	0.0787	24.0	49.0	2.00
A7772.1	-	2.10	0.0827	24.0	49.0	2.10
A7772.2	-	2.20	0.0866	27.0	53.0	2.20
A7772.3	-	2.30	0.0906	27.0	53.0	2.30
A7773/32	3/32	2.38	0.0938	30.0	57.0	2.38
A7772.4	-	2.40	0.0945	30.0	57.0	2.40
A7772.5	-	2.50	0.0984	30.0	57.0	2.50
A7772.6	-	2.60	0.1024	30.0	57.0	2.60
A7772.7	-	2.70	0.1063	33.0	61.0	2.70
A7777/64	7/64	2.78	0.1094	33.0	61.0	2.78
A7772.8	-	2.80	0.1102	33.0	61.0	2.80
A7772.9	-	2.90	0.1142	33.0	61.0	2.90
A7773.0	-	3.00	0.1181	33.0	61.0	3.00
A7773.1	-	3.10	0.1220	36.0	65.0	3.10
A7771/8	1/8	3.18	0.1250	36.0	65.0	3.18
A7773.2	-	3.20	0.1260	36.0	65.0	3.20
A7773.3	-	3.30	0.1299	36.0	65.0	3.30
A7773.4	-	3.40	0.1339	39.0	70.0	3.40
A7773.5	-	3.50	0.1378	39.0	70.0	3.50
A7779/64	9/64	3.57	0.1406	39.0	70.0	3.57
A7773.6	-	3.60	0.1417	39.0	70.0	3.60
A7773.7	-	3.70	0.1457	39.0	70.0	3.70
A7773.8	-	3.80	0.1496	43.0	75.0	3.80
A7773.9	-	3.90	0.1535	43.0	75.0	3.90



Producto	DC	DC	DC	LCF	OAL	DCON MS
	(inch)	(mm)	(inch)	(mm)	(mm)	(mm)
A7775/32	5/32	3.97	0.1563	43.0	75.0	3.97
A7774.0	–	4.00	0.1575	43.0	75.0	4.00
A7774.1	–	4.10	0.1614	43.0	75.0	4.10
A7774.2	–	4.20	0.1654	43.0	75.0	4.20
A7774.3	–	4.30	0.1693	47.0	80.0	4.30
A77711/64	11/64	4.37	0.1719	47.0	80.0	4.37
A7774.4	–	4.40	0.1732	47.0	80.0	4.40
A7774.5	–	4.50	0.1772	47.0	80.0	4.50
A7774.6	–	4.60	0.1811	47.0	80.0	4.60
A7774.7	–	4.70	0.1850	47.0	80.0	4.70
A7773/16	3/16	4.76	0.1875	52.0	86.0	4.76
A7774.8	–	4.80	0.1890	52.0	86.0	4.80
A7774.9	–	4.90	0.1929	52.0	86.0	4.90
A7775.0	–	5.00	0.1969	52.0	86.0	5.00
A7775.1	–	5.10	0.2008	52.0	86.0	5.10
A77713/64	13/64	5.16	0.2031	52.0	86.0	5.16
A7775.2	–	5.20	0.2047	52.0	86.0	5.20
A7775.3	–	5.30	0.2087	52.0	86.0	5.30
A7775.4	–	5.40	0.2126	57.0	93.0	5.40
A7775.5	–	5.50	0.2165	57.0	93.0	5.50
A7777/32	7/32	5.56	0.2188	57.0	93.0	5.56
A7775.6	–	5.60	0.2205	57.0	93.0	5.60
A7775.7	–	5.70	0.2244	57.0	93.0	5.70
A7775.8	–	5.80	0.2283	57.0	93.0	5.80
A7775.9	–	5.90	0.2323	57.0	93.0	5.90
A77715/64	15/64	5.95	0.2344	57.0	93.0	5.95
A7776.0	–	6.00	0.2362	57.0	93.0	6.00
A7776.1	–	6.10	0.2402	63.0	101.0	6.10
A7776.2	–	6.20	0.2441	63.0	101.0	6.20
A7776.3	–	6.30	0.2480	63.0	101.0	6.30
A7771/4	1/4	6.35	0.2500	63.0	101.0	6.35
A7776.4	–	6.40	0.2520	63.0	101.0	6.40
A7776.5	–	6.50	0.2559	63.0	101.0	6.50
A7776.6	–	6.60	0.2598	63.0	101.0	6.60
A7776.7	–	6.70	0.2638	63.0	101.0	6.70
A77717/64	17/64	6.75	0.2656	69.0	109.0	6.75
A7776.8	–	6.80	0.2677	69.0	109.0	6.80
A7776.9	–	6.90	0.2717	69.0	109.0	6.90
A7777.0	–	7.00	0.2756	69.0	109.0	7.00
A7777.1	–	7.10	0.2795	69.0	109.0	7.10
A7779/32	9/32	7.14	0.2813	69.0	109.0	7.14
A7777.2	–	7.20	0.2835	69.0	109.0	7.20
A7777.3	–	7.30	0.2874	69.0	109.0	7.30
A7777.4	–	7.40	0.2913	69.0	109.0	7.40
A7777.5	–	7.50	0.2953	69.0	109.0	7.50
A77719/64	19/64	7.54	0.2969	75.0	117.0	7.54
A7777.6	–	7.60	0.2992	75.0	117.0	7.60
A7777.7	–	7.70	0.3031	75.0	117.0	7.70
A7777.8	–	7.80	0.3071	75.0	117.0	7.80
A7777.9	–	7.90	0.3110	75.0	117.0	7.90
A7775/16	5/16	7.94	0.3125	75.0	117.0	7.94
A7778.0	–	8.00	0.3150	75.0	117.0	8.00

Producto	DC	DC	DC	LCF	OAL	DCON MS
	(inch)	(mm)	(inch)	(mm)	(mm)	(mm)
A7778.1	–	8.10	0.3189	75.0	117.0	8.10
A7778.2	–	8.20	0.3228	75.0	117.0	8.20
A7778.3	–	8.30	0.3268	75.0	117.0	8.30
A77721/64	21/64	8.33	0.3281	75.0	117.0	8.33
A7778.4	–	8.40	0.3307	75.0	117.0	8.40
A7778.5	–	8.50	0.3346	75.0	117.0	8.50
A7778.6	–	8.60	0.3386	81.0	125.0	8.60
A7778.7	–	8.70	0.3425	81.0	125.0	8.70
A77711/32	11/32	8.73	0.3438	81.0	125.0	8.73
A7778.8	–	8.80	0.3465	81.0	125.0	8.80
A7778.9	–	8.90	0.3504	81.0	125.0	8.90
A7779.0	–	9.00	0.3543	81.0	125.0	9.00
A7779.1	–	9.10	0.3583	81.0	125.0	9.10
A77723/64	23/64	9.13	0.3594	81.0	125.0	9.13
A7779.2	–	9.20	0.3622	81.0	125.0	9.20
A7779.3	–	9.30	0.3661	81.0	125.0	9.30
A7779.4	–	9.40	0.3701	81.0	125.0	9.40
A7779.5	–	9.50	0.3740	81.0	125.0	9.50
A7773/8	3/8	9.52	0.3750	87.0	133.0	9.52
A7779.6	–	9.60	0.3780	87.0	133.0	9.60
A7779.7	–	9.70	0.3819	87.0	133.0	9.70
A7779.8	–	9.80	0.3858	87.0	133.0	9.80
A7779.9	–	9.90	0.3898	87.0	133.0	9.90
A77725/64	25/64	9.92	0.3906	87.0	133.0	9.92
A77710.0	–	10.00	0.3937	87.0	133.0	10.00
A77710.1	–	10.10	0.3976	87.0	133.0	10.10
A77710.2	–	10.20	0.4016	87.0	133.0	10.20
A77713/32	13/32	10.32	0.4063	87.0	133.0	10.32
A77710.5	–	10.50	0.4134	87.0	133.0	10.50
A77727/64	27/64	10.72	0.4219	94.0	142.0	10.72
A77710.8	–	10.80	0.4252	94.0	142.0	10.80
A77711.0	–	11.00	0.4331	94.0	142.0	11.00
A7777/16	7/16	11.11	0.4375	94.0	142.0	11.11
A77711.2	–	11.20	0.4409	94.0	142.0	11.20
A77711.5	–	11.50	0.4528	94.0	142.0	11.50
A77729/64	29/64	11.51	0.4531	94.0	142.0	11.51
A77711.8	–	11.80	0.4646	94.0	142.0	11.80
A77715/32	15/32	11.91	0.4688	101.0	151.0	11.91
A77712.0	–	12.00	0.4724	101.0	151.0	12.00
A77712.2	–	12.20	0.4803	101.0	151.0	12.20
A77731/64	31/64	12.30	0.4844	101.0	151.0	12.30
A77712.5	–	12.50	0.4921	101.0	151.0	12.50
A7771/2	1/2	12.70	0.5000	101.0	151.0	12.70
A77712.8	–	12.80	0.5039	101.0	151.0	12.80
A77713.0	–	13.00	0.5118	101.0	151.0	13.00
A77713.5	–	13.50	0.5315	108.0	160.0	13.50
A77714.0	–	14.00	0.5512	108.0	160.0	14.00
A77714.5	–	14.50	0.5709	114.0	169.0	14.50
A77715.0	–	15.00	0.5906	114.0	169.0	15.00
A77715.5	–	15.50	0.6102	120.0	178.0	15.50
A77716.0	–	16.00	0.6299	120.0	178.0	16.00



A160



Broca HSS, Serie Corta con Punta de Metal Duro Soldada, Acabado Templado al Vapor

Cuerpo de HSS con punta soldada de metal duro, que proporciona el rendimiento de una broca de metal duro y la resistencia de una broca con cuerpo de HSS menos quebradizo. La punta de 118° y 4 facetas mejora el auto-centrado y es fácil de reafilarse, lo que la convierte en una opción económica para taladrar fundición. Se puede utilizar tanto en máquinas convencionales como CNC.

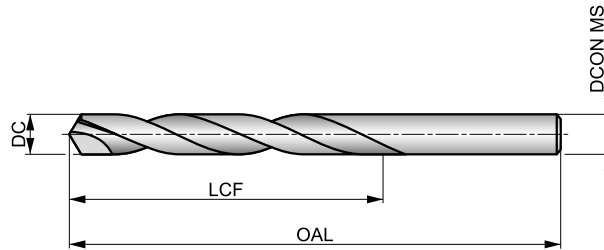

HSS HM	DIN 338	4xD
118°	Bright ST	
λ 20-35°	R	DC h8

Grupo de Material de la pieza adecuado y condiciones de velocidad de corte iniciales (m/min) y código de avance alfabético. Tablas con avance por revolución a partir de la pag.175.

P1.1 ▣73 E	P1.2 ▣82 E	P1.3 ▣85 E	P2.1 ▣63 E	P2.2 ▣55 D	P2.3 ▣49 C	P3.1 ▣59 D	P3.2 ▣47 D	P3.3 ▣40 C	P4.1 ▣35 D	P4.2 ▣30 C	P4.3 ▣24 A	M1.1 ▣55 B	M1.2 ▣46 B
M2.1 ▣49 B	M2.2 ▣40 B	M3.1 ▣41 C	M3.2 ▣35 C	M3.3 ▣32 C	M4.1 ▣35 A	K1.1 ▣50 C	K1.2 ▣37 A	K1.3 ▣28 A	K2.1 ▣43 A	K2.2 ▣35 A	K2.3 ▣28 A	K3.1 ▣38 A	K3.2 ▣29 A
K3.3 ▣24 A	K4.1 ▣35 A	K4.2 ▣27 A	K4.3 ▣20 A	K4.4 ▣17 A	K4.5 ▣14 A	K5.1 ▣40 A	K5.2 ▣30 A	K5.3 ▣23 A	N1.1 ▣50 I	N1.2 ▣38 I	N1.3 ▣25 H	N2.1 ▣62 G	N2.2 ▣55 G
N2.3 ▣40 G	N3.1 ▣119 C	N3.2 ▣70 G	N3.3 ▣35 D	N4.2 ▣60 E	S1.1 ▣35 A	S1.2 ▣35 A	S1.3 ▣25 A	S2.1 ▣33 A	S2.2 ▣28 A	S3.1 ▣25 A	S3.2 ▣20 A	S4.1 ▣20 A	S4.2 ▣16 A

Producto	DC	DC	LCF	OAL	DCON MS
	(mm)	(inch)			
A1604.0	4.00	0.1575	43.0	75.0	4.00
A1604.5	4.50	0.1772	47.0	80.0	4.50
A1605.0	5.00	0.1969	52.0	86.0	5.00
A1605.5	5.50	0.2165	57.0	93.0	5.50
A1606.0	6.00	0.2362	57.0	93.0	6.00
A1606.5	6.50	0.2559	63.0	101.0	6.50
A1606.8	6.80	0.2677	69.0	109.0	6.80
A1607.0	7.00	0.2756	69.0	109.0	7.00
A1607.5	7.50	0.2953	69.0	109.0	7.50
A1608.0	8.00	0.3150	75.0	117.0	8.00
A1608.5	8.50	0.3346	75.0	117.0	8.50
A1609.0	9.00	0.3543	81.0	125.0	9.00
A1609.5	9.50	0.3740	81.0	125.0	9.50
A16010.0	10.00	0.3937	87.0	133.0	10.00
A16010.2	10.20	0.4016	87.0	133.0	10.20
A16010.5	10.50	0.4134	87.0	133.0	10.50
A16011.0	11.00	0.4331	94.0	142.0	11.00
A16011.5	11.50	0.4528	94.0	142.0	11.50
A16012.0	12.00	0.4724	101.0	151.0	12.00
A16013.0	13.00	0.5118	101.0	151.0	13.00
A16014.0	14.00	0.5512	108.0	160.0	14.00
A16015.0	15.00	0.5906	114.0	169.0	15.00
A16016.0	16.00	0.6299	120.0	178.0	16.00



A510



Broca ADX HSS, Serie Corta, con Recubrimiento TiN

Broca de alto rendimiento, capaz de producir agujeros precisos y de alta calidad a altas velocidades y avances (tolerancia de agujero H9). La punta adelgazada a 130° mejora el autocentrado. Esta broca se debe utilizar únicamente en máquinas con avance constante. El recubrimiento TiN mejora el rendimiento y prolonga la vida de la herramienta. Apta para taladrar la mayoría de materiales.

ADX

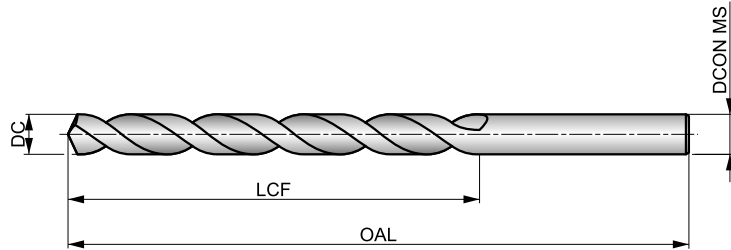

HSS	DIN 338	4xD
130°	TiN	
λ 32-40°	R	DC h8

Grupo de Material de la pieza adecuado y condiciones de velocidad de corte iniciales (m/min) y código de avance alfabético. Tablas con avance por revolución a partir de la pag.175.

P1.1 ■ 53 M	P1.2 ■ 59 M	P1.3 ■ 61 M	P2.1 ■ 45 M	P2.2 ■ 40 K	P2.3 ■ 35 F	P3.1 ■ 31 H	P3.2 ■ 25 H	P3.3 ■ 21 F	P4.1 ■ 19 H	P4.2 ■ 16 F	P4.3 ■ 13 D	M1.1 ■ 38 G	M1.2 ■ 32 G
M2.1 ■ 34 G	M2.2 ■ 28 G	M3.1 ■ 16 I	M3.2 ■ 14 I	M3.3 ■ 13 I	M4.1 ■ 19 G	K1.1 ■ 42 K	K1.2 ■ 31 J	K1.3 ■ 23 J	K2.1 ■ 34 J	K2.2 ■ 28 J	K2.3 ■ 22 F	K3.1 ■ 30 J	K3.2 ■ 23 J
K3.3 ■ 19 F	K4.1 ■ 28 J	K4.2 ■ 21 J	K4.3 ■ 16 F	K4.4 ■ 13 F	K4.5 ■ 11 F	K5.1 ■ 32 J	K5.2 ■ 24 J	K5.3 ■ 19 F	N1.1 ■ 50 G	N1.2 ■ 38 G	N1.3 ■ 25 M	N2.1 ■ 48 I	N2.2 ■ 43 I
N2.3 ■ 31 I	N3.1 ■ 85 I	N3.2 ■ 50 I	N3.3 ■ 25 D	N4.1 ■ 65 G	N4.2 ■ 50 G	N4.3 ■ 35 F	S1.1 ■ 32 G	S1.2 ■ 20 H	S1.3 ■ 4 B	S2.1 ■ 12 E	S2.2 ■ 8 E	S3.1 ■ 9 E	S3.2 ■ 6 E
S4.1 ■ 7 E	S4.2 ■ 5 E												

Producto	DC (inch)	DC (mm)	DC (inch)	LCF (mm)	OAL (mm)	DCON MS (mm)
A5103.0	—	3.00	0.1181	33.0	61.0	3.00
A5103.1	—	3.10	0.1220	36.0	65.0	3.10
A5101/8	1/8	3.18	0.1250	36.0	65.0	3.18
A5103.2	—	3.20	0.1260	36.0	65.0	3.20
A5103.3	—	3.30	0.1299	36.0	65.0	3.30
A5103.4	—	3.40	0.1339	39.0	70.0	3.40
A5103.5	—	3.50	0.1378	39.0	70.0	3.50
A5109/64	9/64	3.57	0.1406	39.0	70.0	3.57
A5103.6	—	3.60	0.1417	39.0	70.0	3.60
A5103.7	—	3.70	0.1457	39.0	70.0	3.70
A5103.8	—	3.80	0.1496	43.0	75.0	3.80
A5103.9	—	3.90	0.1535	43.0	75.0	3.90
A5105/32	5/32	3.97	0.1563	43.0	75.0	3.97
A5104.0	—	4.00	0.1575	43.0	75.0	4.00
A5104.1	—	4.10	0.1614	43.0	75.0	4.10
A5104.2	—	4.20	0.1654	43.0	75.0	4.20
A5104.3	—	4.30	0.1693	47.0	80.0	4.30
A51011/64	11/64	4.37	0.1719	47.0	80.0	4.37
A5104.4	—	4.40	0.1732	47.0	80.0	4.40
A5104.5	—	4.50	0.1772	47.0	80.0	4.50
A5104.6	—	4.60	0.1811	47.0	80.0	4.60
A5104.7	—	4.70	0.1850	47.0	80.0	4.70
A5103/16	3/16	4.76	0.1875	52.0	86.0	4.76
A5104.8	—	4.80	0.1890	52.0	86.0	4.80

Producto	DC (inch)	DC (mm)	DC (inch)	LCF (mm)	OAL (mm)	DCON MS (mm)
A5104.9	—	4.90	0.1929	52.0	86.0	4.90
A5105.0	—	5.00	0.1969	52.0	86.0	5.00
A5105.1	—	5.10	0.2008	52.0	86.0	5.10
A51013/64	13/64	5.16	0.2031	52.0	86.0	5.16
A5105.2	—	5.20	0.2047	52.0	86.0	5.20
A5105.3	—	5.30	0.2087	52.0	86.0	5.30
A5105.4	—	5.40	0.2126	57.0	93.0	5.40
A5105.5	—	5.50	0.2165	57.0	93.0	5.50
A5107/32	7/32	5.56	0.2188	57.0	93.0	5.56
A5105.6	—	5.60	0.2205	57.0	93.0	5.60
A5105.7	—	5.70	0.2244	57.0	93.0	5.70
A5105.8	—	5.80	0.2283	57.0	93.0	5.80
A5105.9	—	5.90	0.2323	57.0	93.0	5.90
A51015/64	15/64	5.95	0.2344	57.0	93.0	5.95
A5106.0	—	6.00	0.2362	57.0	93.0	6.00
A5106.1	—	6.10	0.2402	63.0	101.0	6.10
A5106.2	—	6.20	0.2441	63.0	101.0	6.20
A5106.3	—	6.30	0.2480	63.0	101.0	6.30
A5101/4	1/4	6.35	0.2500	63.0	101.0	6.35
A5106.4	—	6.40	0.2520	63.0	101.0	6.40
A5106.5	—	6.50	0.2559	63.0	101.0	6.50
A5106.6	—	6.60	0.2598	63.0	101.0	6.60
A5106.7	—	6.70	0.2638	63.0	101.0	6.70
A51017/64	17/64	6.75	0.2656	69.0	109.0	6.75



Producto	DC	DC	DC	LCF	OAL	D CON MS
	(inch)	(mm)	(inch)	(mm)	(mm)	(mm)
A5106.8	—	6.80	0.2677	69.0	109.0	6.80
A5106.9	—	6.90	0.2717	69.0	109.0	6.90
A5107.0	—	7.00	0.2756	69.0	109.0	7.00
A5107.1	—	7.10	0.2795	69.0	109.0	7.10
A5109/32	9/32	7.14	0.2813	69.0	109.0	7.14
A5107.2	—	7.20	0.2835	69.0	109.0	7.20
A5107.3	—	7.30	0.2874	69.0	109.0	7.30
A5107.4	—	7.40	0.2913	69.0	109.0	7.40
A5107.5	—	7.50	0.2953	69.0	109.0	7.50
A51019/64	19/64	7.54	0.2969	75.0	117.0	7.54
A5107.6	—	7.60	0.2992	75.0	117.0	7.60
A5107.7	—	7.70	0.3031	75.0	117.0	7.70
A5107.8	—	7.80	0.3071	75.0	117.0	7.80
A5107.9	—	7.90	0.3110	75.0	117.0	7.90
A5105/16	5/16	7.94	0.3125	75.0	117.0	7.94
A5108.0	—	8.00	0.3150	75.0	117.0	8.00
A5108.1	—	8.10	0.3189	75.0	117.0	8.10
A5108.2	—	8.20	0.3228	75.0	117.0	8.20
A5108.3	—	8.30	0.3268	75.0	117.0	8.30
A51021/64	21/64	8.33	0.3281	75.0	117.0	8.33
A5108.4	—	8.40	0.3307	75.0	117.0	8.40
A5108.5	—	8.50	0.3346	75.0	117.0	8.50
A5108.6	—	8.60	0.3386	81.0	125.0	8.60
A5108.7	—	8.70	0.3425	81.0	125.0	8.70
A51011/32	11/32	8.73	0.3438	81.0	125.0	8.73
A5108.8	—	8.80	0.3465	81.0	125.0	8.80
A5108.9	—	8.90	0.3504	81.0	125.0	8.90
A5109.0	—	9.00	0.3543	81.0	125.0	9.00
A5109.1	—	9.10	0.3583	81.0	125.0	9.10
A51023/64	23/64	9.13	0.3594	81.0	125.0	9.13
A5109.2	—	9.20	0.3622	81.0	125.0	9.20
A5109.3	—	9.30	0.3661	81.0	125.0	9.30
A5109.4	—	9.40	0.3701	81.0	125.0	9.40
A5109.5	—	9.50	0.3740	81.0	125.0	9.50
A5103/8	3/8	9.52	0.3750	87.0	133.0	9.52
A5109.6	—	9.60	0.3780	87.0	133.0	9.60
A5109.7	—	9.70	0.3819	87.0	133.0	9.70
A5109.8	—	9.80	0.3858	87.0	133.0	9.80
A5109.9	—	9.90	0.3898	87.0	133.0	9.90
A51025/64	25/64	9.92	0.3906	87.0	133.0	9.92

Producto	DC	DC	DC	LCF	OAL	D CON MS
	(inch)	(mm)	(inch)	(mm)	(mm)	(mm)
A51010.0	—	10.00	0.3937	87.0	133.0	10.00
A51010.1	—	10.10	0.3976	87.0	133.0	10.10
A51010.2	—	10.20	0.4016	87.0	133.0	10.20
A51010.3	—	10.30	0.4055	87.0	133.0	10.30
A51013/32	13/32	10.32	0.4063	87.0	133.0	10.32
A51010.4	—	10.40	0.4094	87.0	133.0	10.40
A51010.5	—	10.50	0.4134	87.0	133.0	10.50
A51010.6	—	10.60	0.4173	87.0	133.0	10.60
A51010.7	—	10.70	0.4213	94.0	142.0	10.70
A51027/64	27/64	10.72	0.4219	94.0	142.0	10.72
A51010.8	—	10.80	0.4252	94.0	142.0	10.80
A51010.9	—	10.90	0.4291	94.0	142.0	10.90
A51011.0	—	11.00	0.4331	94.0	142.0	11.00
A51011.1	—	11.10	0.4370	94.0	142.0	11.10
A5107/16	7/16	11.11	0.4375	94.0	142.0	11.11
A51011.2	—	11.20	0.4409	94.0	142.0	11.20
A51011.3	—	11.30	0.4449	94.0	142.0	11.30
A51011.4	—	11.40	0.4488	94.0	142.0	11.40
A51011.5	—	11.50	0.4528	94.0	142.0	11.50
A51029/64	29/64	11.51	0.4531	94.0	142.0	11.51
A51011.6	—	11.60	0.4567	94.0	142.0	11.60
A51011.7	—	11.70	0.4606	94.0	142.0	11.70
A51011.8	—	11.80	0.4646	94.0	142.0	11.80
A51011.9	—	11.90	0.4685	101.0	151.0	11.90
A51015/32	15/32	11.91	0.4688	101.0	151.0	11.91
A51012.0	—	12.00	0.4724	101.0	151.0	12.00
A51012.1	—	12.10	0.4764	101.0	151.0	12.10
A51012.2	—	12.20	0.4803	101.0	151.0	12.20
A51012.3	—	12.30	0.4843	101.0	151.0	12.30
A51031/64	31/64	12.30	0.4844	101.0	151.0	12.30
A51012.4	—	12.40	0.4882	101.0	151.0	12.40
A51012.5	—	12.50	0.4921	101.0	151.0	12.50
A51012.6	—	12.60	0.4961	101.0	151.0	12.60
A51012.7	—	12.70	0.5000	101.0	151.0	12.70
A5101/2	1/2	12.70	0.5000	101.0	151.0	12.70
A51012.8	—	12.80	0.5039	101.0	151.0	12.80
A51012.9	—	12.90	0.5079	101.0	151.0	12.90
A51013.0	—	13.00	0.5118	101.0	151.0	13.00
A51014.0	—	14.00	0.5512	108.0	160.0	14.00



A553



Broca ADX HSS-E (5% Cobalto), Serie Corta, con Refrigeración Interna, con Recubrimiento TiAlN Top

Broca de alto rendimiento, capaz de producir agujeros precisos y de alta calidad a altas velocidades y avances (tolerancia de agujero H9). La punta adelgazada a 130° y el recubrimiento TiAlN Top mejoran el rendimiento y prolongan la vida de la herramienta. Esta broca se debe utilizar únicamente en máquinas CNC. Apta para taladrar la mayoría de materiales.

ADX

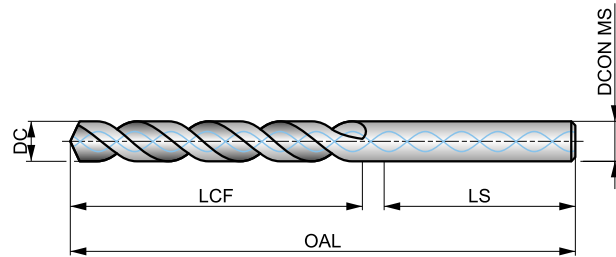

HSS-E	DORMER	5xD
130°	TiAlN Top	DIN 6535HA
$\lambda > 35^\circ$	R	Internal Cooling
DC h8		

Grupo de Material de la pieza adecuado y condiciones de velocidad de corte iniciales (m/min) y código de avance alfabético. Tablas con avance por revolución a partir de la pag.175.

P1.1 ■ 80 L	P1.2 ■ 89 L	P1.3 ■ 92 L	P2.1 ■ 68 L	P2.2 ■ 60 L	P2.3 ■ 53 F	P3.1 ■ 41 H	P3.2 ■ 33 H	P3.3 ■ 28 F	P4.1 ■ 25 H	P4.2 ■ 21 F	P4.3 ■ 17 D	M1.1 ■ 55 G	M1.2 ■ 46 G
M2.1 ■ 49 G	M2.2 ■ 40 G	M3.1 ■ 22 I	M3.2 ■ 19 I	M3.3 ■ 17 I	M4.1 ■ 27 G	K1.1 ■ 70 K	K1.2 ■ 52 J	K1.3 ■ 39 J	K2.1 ■ 55 J	K2.2 ■ 45 J	K2.3 ■ 36 F	K3.1 ■ 49 J	K3.2 ■ 37 J
K3.3 ■ 30 F	K4.1 ■ 45 J	K4.2 ■ 34 J	K4.3 ■ 25 F	K4.4 ■ 22 F	K4.5 ■ 18 F	K5.1 ■ 51 J	K5.2 ■ 39 J	K5.3 ■ 30 F	N1.1 ■ 70 H	N1.2 ■ 53 H	N1.3 ■ 35 M	N2.1 ■ 85 I	N2.2 ■ 76 I
N2.3 ■ 55 I	N3.1 ■ 144 I	N3.2 ■ 85 I	N3.3 ■ 43 G	N4.1 ■ 90 G	S1.1 ■ 45 G	S1.2 ■ 30 E	S1.3 ■ 8 C	S2.1 ■ 20 E	S2.2 ■ 14 G	S3.1 ■ 15 E	S3.2 ■ 10 G	S4.1 ■ 12 E	S4.2 ■ 8 G

DCON MS tolerancia h6.

Producto	DC (mm)	DC (inch)	LCF (mm)	OAL (mm)	LS (mm)	DCON MS (mm)
A5535.0	5.00	0.1969	36.0	79.0	36.0	6.00
A5535.2	5.20	0.2047	38.0	79.0	36.0	6.00
A5535.5	5.50	0.2165	40.0	79.0	36.0	6.00
A5536.0	6.00	0.2362	43.0	79.0	36.0	6.00
A5536.3	6.30	0.2480	46.0	87.0	36.0	8.00
A5536.5	6.50	0.2559	47.0	87.0	36.0	8.00
A5536.8	6.80	0.2677	48.0	87.0	36.0	8.00
A5536.9	6.90	0.2717	48.0	87.0	36.0	8.00
A5537.0	7.00	0.2756	48.0	87.0	36.0	8.00
A5537.4	7.40	0.2913	54.0	94.0	36.0	8.00
A5537.5	7.50	0.2953	54.0	94.0	36.0	8.00
A5538.0	8.00	0.3150	58.0	94.0	36.0	8.00
A5538.5	8.50	0.3346	75.0	130.0	40.0	10.00
A5538.7	8.70	0.3425	75.0	130.0	40.0	10.00
A5539.0	9.00	0.3543	75.0	130.0	40.0	10.00
A5539.5	9.50	0.3740	75.0	130.0	40.0	10.00
A55310.0	10.00	0.3937	75.0	130.0	40.0	10.00
A55310.2	10.20	0.4016	87.0	150.0	45.0	12.00
A55310.3	10.30	0.4055	87.0	150.0	45.0	12.00
A55310.5	10.50	0.4134	87.0	150.0	45.0	12.00
A55311.0	11.00	0.4331	94.0	150.0	45.0	12.00
A55311.3	11.30	0.4449	94.0	150.0	45.0	12.00
A55311.5	11.50	0.4528	94.0	150.0	45.0	12.00
A55312.0	12.00	0.4724	94.0	150.0	45.0	12.00
A55312.5	12.50	0.4921	101.0	160.0	45.0	14.00
A55313.0	13.00	0.5118	101.0	160.0	45.0	14.00
A55313.5	13.50	0.5315	101.0	160.0	45.0	14.00
A55314.0	14.00	0.5512	101.0	160.0	45.0	14.00
A55314.25	14.25	0.5610	108.0	170.0	48.0	16.00
A55314.5	14.50	0.5709	108.0	170.0	48.0	16.00
A55315.0	15.00	0.5906	108.0	170.0	48.0	16.00
A55315.25	15.25	0.6004	108.0	170.0	48.0	16.00
A55315.5	15.50	0.6102	108.0	170.0	48.0	16.00
A55316.0	16.00	0.6299	108.0	170.0	48.0	16.00
A55316.5	16.50	0.6496	125.0	190.0	48.0	18.00
A55317.0	17.00	0.6693	125.0	190.0	48.0	18.00
A55317.5	17.50	0.6890	130.0	190.0	48.0	18.00
A55317.75	17.75	0.6988	130.0	190.0	48.0	18.00
A55318.0	18.00	0.7087	130.0	190.0	48.0	18.00
A55319.0	19.00	0.7480	135.0	200.0	50.0	20.00
A55319.25	19.25	0.7579	140.0	200.0	50.0	20.00
A55320.0	20.00	0.7874	140.0	200.0	50.0	20.00



A900



Broca PFX HSS-E (5% Cobalto), Serie Corta, Acabado Brillante

Broca de alto rendimiento, capaz de producir agujeros precisos y de alta calidad a altas velocidades y avances (tolerancia de agujero H10). La punta autocentrante a 130° y el diseño especial parabólico de los canales ayudan a taladrar agujeros profundos en una sola pasada. Apta para la mayoría de materiales.



PFX

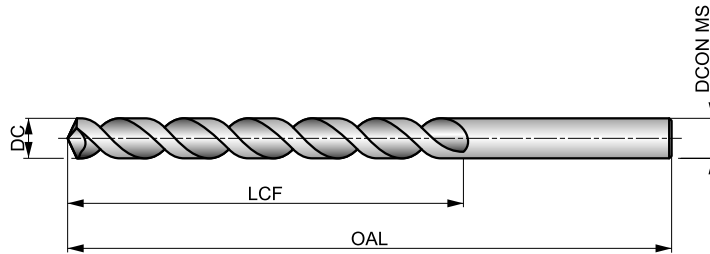

HSS-E	DIN ANSI	6xD
130°	Bright	
λ>35°	R	DC h8

Grupo de Material de la pieza adecuado y condiciones de velocidad de corte iniciales (m/min) y código de avance alfabético. Tablas con avance por revolución a partir de la pag.175.

P1.1 ■ 34 H	P1.2 ■ 39 H	P1.3 ■ 40 H	P2.1 ■ 30 H	P2.2 ■ 26 H	P2.3 ■ 23 E	P3.1 ■ 31 H	P3.2 ■ 25 H	P3.3 ■ 21 E	P4.1 ■ 19 H	P4.2 ■ 16 E	P4.3 ■ 13 E	M1.1 ■ 21 E	M1.2 ■ 17 E
M2.1 ■ 18 E	M2.2 ■ 15 E	M3.1 ■ 8 E	M3.2 ■ 7 E	M3.3 ■ 6 E	M4.1 ■ 9 C	K1.1 □ 24 J	K1.2 □ 18 J	K1.3 □ 13 J	K2.1 □ 23 J	K2.2 □ 19 J	K2.3 □ 15 I	K3.1 □ 21 J	K3.2 □ 16 J
K3.3 □ 13 I	K4.1 □ 19 J	K4.2 □ 14 J	K4.3 □ 11 I	K4.4 □ 9 I	K4.5 □ 8 I	K5.1 □ 22 J	K5.2 □ 16 J	K5.3 □ 13 I	N1.1 □ 60 J	N1.2 □ 45 J	N1.3 ■ 30 N	N2.1 □ 62 N	N2.2 □ 55 N
N2.3 □ 40 N	N3.1 □ 90 H	N3.2 □ 53 I	N3.3 □ 27 G	N4.1 □ 55 I	N4.2 □ 40 G	S1.1 ■ 22 E	S1.2 ■ 15 E	S1.3 ■ 6 C	S2.1 ■ 9 G	S2.2 ■ 8 C	S3.1 ■ 7 G	S3.2 ■ 6 C	S4.1 ■ 5 G
S4.2 ■ 5 C													

Producto	DC (inch)	DC (mm)	DC (inch)	LCF (mm)	OAL (mm)	DCON MS (mm)
A9001.0	-	1.00	0.0394	12.0	34.0	1.00
A9001.1	-	1.10	0.0433	14.0	36.0	1.10
A9003/64	3/64	1.19	0.0469	19.0	44.0	1.19
A9001.2	-	1.20	0.0472	16.0	38.0	1.20
A9001.25	-	1.25	0.0492	16.0	36.0	1.25
A9001.3	-	1.30	0.0512	16.0	38.0	1.30
A9001.4	-	1.40	0.0551	18.0	40.0	1.40
A9001.5	-	1.50	0.0591	18.0	40.0	1.50
A9001.55	-	1.55	0.0610	20.0	43.0	1.55
A9001/16	1/16	1.59	0.0625	22.0	48.0	1.59
A9001.6	-	1.60	0.0630	20.0	43.0	1.60
A9001.7	-	1.70	0.0669	20.0	43.0	1.70
A9001.75	-	1.75	0.0689	22.0	46.0	1.75
A9001.8	-	1.80	0.0709	22.0	46.0	1.80
A9001.9	-	1.90	0.0748	22.0	46.0	1.90
A9005/64	5/64	1.98	0.0781	25.0	51.0	1.98
A9002.0	-	2.00	0.0787	24.0	49.0	2.00
A9002.1	-	2.10	0.0827	24.0	49.0	2.10
A9002.15	-	2.15	0.0846	27.0	53.0	2.15
A9002.2	-	2.20	0.0866	27.0	53.0	2.20
A9002.3	-	2.30	0.0906	27.0	53.0	2.30
A9003/32	3/32	2.38	0.0937	32.0	57.0	2.38
A9002.4	-	2.40	0.0945	30.0	57.0	2.40
A9002.5	-	2.50	0.0984	30.0	57.0	2.50

Producto	DC (inch)	DC (mm)	DC (inch)	LCF (mm)	OAL (mm)	DCON MS (mm)
A9002.6	-	2.60	0.1024	30.0	57.0	2.60
A9002.7	-	2.70	0.1063	33.0	61.0	2.70
A9007/64	7/64	2.78	0.1094	38.0	67.0	2.78
A9002.8	-	2.80	0.1102	33.0	61.0	2.80
A9002.9	-	2.90	0.1142	33.0	61.0	2.90
A9003.0	-	3.00	0.1181	33.0	61.0	3.00
A9003.1	-	3.10	0.1220	36.0	65.0	3.10
A9001/8	1/8	3.18	0.1250	41.0	70.0	3.18
A9003.2	-	3.20	0.1260	36.0	65.0	3.20
A9003.3	-	3.30	0.1299	36.0	65.0	3.30
A9003.4	-	3.40	0.1339	39.0	70.0	3.40
A9003.5	-	3.50	0.1378	39.0	70.0	3.50
A9009/64	9/64	3.57	0.1406	44.0	73.0	3.57
A9003.6	-	3.60	0.1417	39.0	70.0	3.60
A9003.7	-	3.70	0.1457	39.0	70.0	3.70
A9003.8	-	3.80	0.1496	43.0	75.0	3.80
A9003.9	-	3.90	0.1535	43.0	75.0	3.90
A9005/32	5/32	3.97	0.1563	51.0	79.0	3.97
A9004.0	-	4.00	0.1575	43.0	75.0	4.00
A9004.1	-	4.10	0.1614	43.0	75.0	4.10
A9004.2	-	4.20	0.1654	43.0	75.0	4.20
A9004.3	-	4.30	0.1693	47.0	80.0	4.30
A90011/64	11/64	4.37	0.1719	54.0	83.0	4.37
A9004.4	-	4.40	0.1732	47.0	80.0	4.40



Producto	DC	DC	DC	LCF	OAL	D CON MS
	(inch)	(mm)	(inch)	(mm)	(mm)	(mm)
A9004.5	–	4.50	0.1772	47.0	80.0	4.50
A9004.6	–	4.60	0.1811	47.0	80.0	4.60
A9004.7	–	4.70	0.1850	47.0	80.0	4.70
A9003/16	3/16	4.76	0.1875	59.0	89.0	4.76
A9004.8	–	4.80	0.1890	52.0	86.0	4.80
A9004.9	–	4.90	0.1929	52.0	86.0	4.90
A9005.0	–	5.00	0.1969	52.0	86.0	5.00
A9005.1	–	5.10	0.2008	52.0	86.0	5.10
A90013/64	13/64	5.16	0.2031	62.0	92.0	5.16
A9005.2	–	5.20	0.2047	52.0	86.0	5.20
A9005.3	–	5.30	0.2087	52.0	86.0	5.30
A9005.4	–	5.40	0.2126	57.0	93.0	5.40
A9005.5	–	5.50	0.2165	57.0	93.0	5.50
A9007/32	7/32	5.56	0.2188	64.0	95.0	5.56
A9005.6	–	5.60	0.2205	57.0	93.0	5.60
A9005.7	–	5.70	0.2244	57.0	93.0	5.70
A9005.8	–	5.80	0.2283	57.0	93.0	5.80
A9005.9	–	5.90	0.2323	57.0	93.0	5.90
A90015/64	15/64	5.95	0.2344	67.0	98.0	5.95
A9006.0	–	6.00	0.2362	57.0	93.0	6.00
A9006.1	–	6.10	0.2402	63.0	101.0	6.10
A9006.2	–	6.20	0.2441	63.0	101.0	6.20
A9006.3	–	6.30	0.2480	63.0	101.0	6.30
A9001/4	1/4	6.35	0.2500	70.0	102.0	6.35
A9006.4	–	6.40	0.2520	63.0	101.0	6.40
A9006.5	–	6.50	0.2559	63.0	101.0	6.50
A9006.6	–	6.60	0.2598	63.0	101.0	6.60
A9006.7	–	6.70	0.2638	63.0	101.0	6.70
A90017/64	17/64	6.75	0.2656	73.0	105.0	6.75
A9006.8	–	6.80	0.2677	69.0	109.0	6.80
A9006.9	–	6.90	0.2717	69.0	109.0	6.90
A9007.0	–	7.00	0.2756	69.0	109.0	7.00
A9007.1	–	7.10	0.2795	69.0	109.0	7.10
A9009/32	9/32	7.14	0.2813	75.0	108.0	7.14
A9007.2	–	7.20	0.2835	69.0	109.0	7.20
A9007.3	–	7.30	0.2874	69.0	109.0	7.30
A9007.4	–	7.40	0.2913	69.0	109.0	7.40
A9007.5	–	7.50	0.2953	69.0	109.0	7.50
A90019/64	19/64	7.54	0.2969	78.0	111.0	7.54
A9007.6	–	7.60	0.2992	75.0	117.0	7.60
A9007.7	–	7.70	0.3031	75.0	117.0	7.70
A9007.8	–	7.80	0.3071	75.0	117.0	7.80
A9007.9	–	7.90	0.3110	75.0	117.0	7.90
A9005/16	5/16	7.94	0.3125	81.0	114.0	7.94
A9008.0	–	8.00	0.3150	75.0	117.0	8.00
A9008.1	–	8.10	0.3189	75.0	117.0	8.10
A9008.2	–	8.20	0.3228	75.0	117.0	8.20
A9008.3	–	8.30	0.3268	75.0	117.0	8.30
A90021/64	21/64	8.33	0.3281	84.0	117.0	8.33
A9008.4	–	8.40	0.3307	75.0	117.0	8.40
A9008.5	–	8.50	0.3346	75.0	117.0	8.50
A9008.6	–	8.60	0.3386	81.0	125.0	8.60
A9008.7	–	8.70	0.3425	81.0	125.0	8.70
A90011/32	11/32	8.73	0.3438	87.0	121.0	8.73
A9008.8	–	8.80	0.3465	81.0	125.0	8.80
A9008.9	–	8.90	0.3504	81.0	125.0	8.90
A9009.0	–	9.00	0.3543	81.0	125.0	9.00
A9009.1	–	9.10	0.3583	81.0	125.0	9.10
A90023/64	23/64	9.13	0.3594	89.0	124.0	9.13
A9009.2	–	9.20	0.3622	81.0	125.0	9.20

Producto	DC	DC	DC	LCF	OAL	D CON MS
	(inch)	(mm)	(inch)	(mm)	(mm)	(mm)
A9009.3	–	9.30	0.3661	81.0	125.0	9.30
A9009.4	–	9.40	0.3701	81.0	125.0	9.40
A9009.5	–	9.50	0.3740	81.0	125.0	9.50
A9003/8	3/8	9.52	0.3750	92.0	127.0	9.52
A9009.6	–	9.60	0.3780	87.0	133.0	9.60
A9009.7	–	9.70	0.3819	87.0	133.0	9.70
A9009.8	–	9.80	0.3858	87.0	133.0	9.80
A9009.9	–	9.90	0.3898	87.0	133.0	9.90
A90025/64	25/64	9.92	0.3906	95.0	130.0	9.92
A90010.0	–	10.00	0.3937	87.0	133.0	10.00
A90010.2	–	10.20	0.4016	87.0	133.0	10.20
A90010.3	–	10.30	0.4055	87.0	133.0	10.30
A90013/32	13/32	10.32	0.4063	98.0	133.0	10.32
A90010.4	–	10.40	0.4094	87.0	133.0	10.40
A90010.5	–	10.50	0.4134	87.0	133.0	10.50
A90027/64	27/64	10.72	0.4219	100.0	137.0	10.72
A90010.8	–	10.80	0.4252	94.0	142.0	10.80
A90011.0	–	11.00	0.4331	94.0	142.0	11.00
A9007/16	7/16	11.11	0.4375	103.0	140.0	11.11
A90011.5	–	11.50	0.4528	94.0	142.0	11.50
A90029/64	29/64	11.51	0.4531	106.0	143.0	11.51
A90011.8	–	11.80	0.4646	94.0	142.0	11.80
A90015/32	15/32	11.91	0.4688	110.0	146.0	11.91
A90012.0	–	12.00	0.4724	101.0	151.0	12.00
A90031/64	31/64	12.30	0.4844	111.0	149.0	12.30
A90012.5	–	12.50	0.4921	101.0	151.0	12.50
A9001/2	1/2	12.70	0.5000	101.0	151.0	12.70
A90013.0	–	13.00	0.5118	101.0	151.0	13.00
A90033/64	33/64	13.10	0.5156	122.0	168.0	13.10
A90013.5	–	13.50	0.5315	108.0	160.0	13.50
A90035/64	35/64	13.89	0.5469	122.0	168.0	13.89
A90014.0	–	14.00	0.5512	108.0	160.0	14.00
A9009/16	9/16	14.29	0.5625	122.0	168.0	14.29
A90014.5	–	14.50	0.5709	114.0	169.0	14.50
A90037/64	37/64	14.68	0.5781	122.0	168.0	14.68
A90015.0	–	15.00	0.5906	114.0	169.0	15.00
A90019/32	19/32	15.08	0.5938	132.0	181.0	15.08
A90039/64	39/64	15.48	0.6094	132.0	181.0	15.48
A90015.5	–	15.50	0.6102	120.0	178.0	15.50
A9005/8	5/8	15.88	0.6250	132.0	181.0	15.88
A90016.0	–	16.00	0.6299	120.0	178.0	16.00
A90041/64	41/64	16.27	0.6406	132.0	181.0	16.27
A90016.5	–	16.50	0.6496	125.0	184.0	16.50
A90021/32	21/32	16.67	0.6563	132.0	181.0	16.67
A90017.0	–	17.00	0.6693	125.0	184.0	17.00
A90043/64	43/64	17.07	0.6719	143.0	194.0	17.07
A90011/16	11/16	17.46	0.6875	143.0	194.0	17.46
A90017.5	–	17.50	0.6890	130.0	191.0	17.50
A90045/64	45/64	17.86	0.7031	130.0	191.0	17.86
A90018.0	–	18.00	0.7087	130.0	191.0	18.00
A90023/32	23/32	18.26	0.7188	130.0	191.0	18.26
A90018.5	–	18.50	0.7283	135.0	198.0	18.50
A90047/64	47/64	18.65	0.7344	135.0	198.0	18.65
A90019.0	–	19.00	0.7480	135.0	198.0	19.00
A9003/4	3/4	19.05	0.7500	135.0	198.0	19.05
A90049/64	49/64	19.45	0.7656	135.0	198.0	19.45
A90019.5	–	19.50	0.7677	140.0	205.0	19.50
A90025/32	25/32	19.84	0.7813	140.0	205.0	19.84
A90020.0	–	20.00	0.7874	140.0	205.0	20.00



A901



Broca PFX HSS-E (5% Cobalto), Serie Corta, con Recubrimiento Alcrona Top

Broca de alto rendimiento, capaz de producir agujeros precisos y de alta calidad a altas velocidades y avances (tolerancia de agujero H10). Punta a 130° y diseño especial parabólico de los canales. Apta para la mayoría de materiales. El recubrimiento Alcrona-TOP mejora el rendimiento y prolonga la vida de la herramienta.



PFX

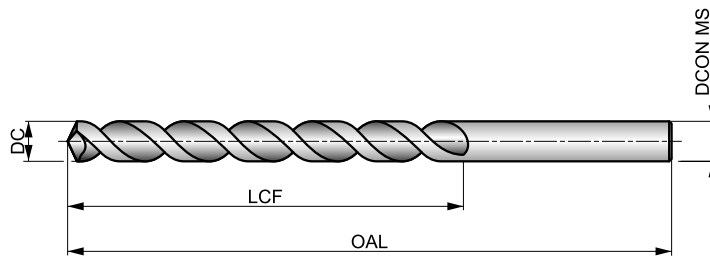

HSS-E	DIN ANSI	6xD
130°	Alcrona Top	
λ>35°	R	DC h8

Grupo de Material de la pieza adecuado y condiciones de velocidad de corte iniciales (m/min) y código de avance alfabético. Tablas con avance por revolución a partir de la pag.175.

P1.1 ■ 58 J	P1.2 ■ 65 J	P1.3 ■ 68 J	P2.1 ■ 50 J	P2.2 ■ 44 I	P2.3 ■ 39 G	P3.1 ■ 49 I	P3.2 ■ 39 I	P3.3 ■ 33 G	P4.1 ■ 29 I	P4.2 ■ 25 G	P4.3 ■ 20 G	M1.1 ■ 23 E	M1.2 ■ 20 E
M2.1 ■ 21 E	M2.2 ■ 17 E	M3.1 ■ 10 E	M3.2 ■ 9 E	M3.3 ■ 8 E	M4.1 ■ 11 C	K1.1 ■ 58 I	K1.2 ■ 43 I	K1.3 ■ 32 I	K2.1 ■ 42 J	K2.2 ■ 34 J	K2.3 ■ 27 I	K3.1 ■ 37 J	K3.2 ■ 28 J
K3.3 ■ 23 I	K4.1 ■ 34 J	K4.2 ■ 26 J	K4.3 ■ 19 I	K4.4 ■ 16 I	K4.5 ■ 14 I	K5.1 ■ 39 J	K5.2 ■ 29 J	K5.3 ■ 23 I	S1.1 ■ 35 G	S1.2 ■ 24 G	S1.3 ■ 10 E	S2.1 ■ 15 I	S2.2 ■ 14 E
S3.1 ■ 11 I	S3.2 ■ 10 E	S4.1 ■ 9 I	S4.2 ■ 8 E										

Producto	DC (inch)	DC (mm)	DC (inch)	LCF (mm)	OAL (mm)	DCON MS (mm)
A9011.5	-	1.50	0.0591	18.0	40.0	1.50
A9011.55	-	1.55	0.0610	20.0	43.0	1.55
A9011/16	1/16	1.59	0.0625	22.0	48.0	1.59
A9011.6	-	1.60	0.0630	20.0	43.0	1.60
A9011.75	-	1.75	0.0689	22.0	46.0	1.75
A9011.8	-	1.80	0.0709	22.0	46.0	1.80
A9011.9	-	1.90	0.0748	22.0	46.0	1.90
A9015/64	5/64	1.98	0.0781	25.0	51.0	1.98
A9012.0	-	2.00	0.0787	24.0	49.0	2.00
A9012.1	-	2.10	0.0827	24.0	49.0	2.10
A9012.15	-	2.15	0.0846	27.0	53.0	2.15
A9013/32	3/32	2.38	0.0937	32.0	57.0	2.38
A9012.4	-	2.40	0.0945	30.0	57.0	2.40
A9012.5	-	2.50	0.0984	30.0	57.0	2.50
A9012.6	-	2.60	0.1024	30.0	57.0	2.60
A9012.7	-	2.70	0.1063	33.0	61.0	2.70
A9017/64	7/64	2.78	0.1094	38.0	67.0	2.78
A9012.9	-	2.90	0.1142	33.0	61.0	2.90
A9013.0	-	3.00	0.1181	33.0	61.0	3.00
A9013.1	-	3.10	0.1220	36.0	65.0	3.10
A9011/8	1/8	3.18	0.1250	41.0	70.0	3.18
A9013.2	-	3.20	0.1260	36.0	65.0	3.20
A9013.3	-	3.30	0.1299	36.0	65.0	3.30
A9013.4	-	3.40	0.1339	39.0	70.0	3.40
A9013.5	-	3.50	0.1378	39.0	70.0	3.50
A9013.6	-	3.60	0.1417	39.0	70.0	3.60

Producto	DC (inch)	DC (mm)	DC (inch)	LCF (mm)	OAL (mm)	DCON MS (mm)
A9019/64	9/64	3.57	0.1406	44.0	73.0	3.57
A9013.7	-	3.70	0.1457	39.0	70.0	3.70
A9013.8	-	3.80	0.1496	43.0	75.0	3.80
A9013.9	-	3.90	0.1535	43.0	75.0	3.90
A9015/32	5/32	3.97	0.1563	51.0	79.0	3.97
A9014.0	-	4.00	0.1575	43.0	75.0	4.00
A9014.1	-	4.10	0.1614	43.0	75.0	4.10
A9014.2	-	4.20	0.1654	43.0	75.0	4.20
A9014.3	-	4.30	0.1693	47.0	80.0	4.30
A90111/64	11/64	4.37	0.1719	54.0	83.0	4.37
A9014.4	-	4.40	0.1732	47.0	80.0	4.40
A9014.5	-	4.50	0.1772	47.0	80.0	4.50
A9014.6	-	4.60	0.1811	47.0	80.0	4.60
A9014.7	-	4.70	0.1850	47.0	80.0	4.70
A9013/16	3/16	4.76	0.1875	59.0	89.0	4.76
A9014.8	-	4.80	0.1890	52.0	86.0	4.80
A9014.9	-	4.90	0.1929	52.0	86.0	4.90
A9015.0	-	5.00	0.1969	52.0	86.0	5.00
A9015.1	-	5.10	0.2008	52.0	86.0	5.10
A90113/64	13/64	5.16	0.2031	62.0	92.0	5.16
A9015.2	-	5.20	0.2047	52.0	86.0	5.20
A9015.3	-	5.30	0.2087	52.0	86.0	5.30
A9015.4	-	5.40	0.2126	57.0	93.0	5.40
A9015.5	-	5.50	0.2165	57.0	93.0	5.50
A9017/32	7/32	5.56	0.2188	64.0	95.0	5.56
A9015.6	-	5.60	0.2205	57.0	93.0	5.60



Producto	DC	DC	DC	LCF	OAL	DCON MS
	(inch)	(mm)	(inch)	(mm)	(mm)	(mm)
A9015.7	–	5.70	0.2244	57.0	93.0	5.70
A9015.8	–	5.80	0.2283	57.0	93.0	5.80
A9015.9	–	5.90	0.2323	57.0	93.0	5.90
A90115/64	15/64	5.95	0.2344	67.0	98.0	5.95
A9016.0	–	6.00	0.2362	57.0	93.0	6.00
A9016.1	–	6.10	0.2402	63.0	101.0	6.10
A9016.2	–	6.20	0.2441	63.0	101.0	6.20
A9016.3	–	6.30	0.2480	63.0	101.0	6.30
A9011/4	1/4	6.35	0.2500	70.0	102.0	6.35
A9016.4	–	6.40	0.2520	63.0	101.0	6.40
A9016.5	–	6.50	0.2559	63.0	101.0	6.50
A9016.6	–	6.60	0.2598	63.0	101.0	6.60
A9016.7	–	6.70	0.2638	63.0	101.0	6.70
A90117/64	17/64	6.75	0.2656	73.0	105.0	6.75
A9016.8	–	6.80	0.2677	69.0	109.0	6.80
A9016.9	–	6.90	0.2717	69.0	109.0	6.90
A9017.0	–	7.00	0.2756	69.0	109.0	7.00
A9017.1	–	7.10	0.2795	69.0	109.0	7.10
A9019/32	9/32	7.14	0.2813	75.0	108.0	7.14
A9017.2	–	7.20	0.2835	69.0	109.0	7.20
A9017.3	–	7.30	0.2874	69.0	109.0	7.30
A9017.4	–	7.40	0.2913	69.0	109.0	7.40
A9017.5	–	7.50	0.2953	69.0	109.0	7.50
A90119/64	19/64	7.54	0.2969	78.0	111.0	7.54
A9017.6	–	7.60	0.2992	75.0	117.0	7.60
A9017.7	–	7.70	0.3031	75.0	117.0	7.70
A9017.8	–	7.80	0.3071	75.0	117.0	7.80
A9017.9	–	7.90	0.3110	75.0	117.0	7.90
A9015/16	5/16	7.94	0.3125	81.0	114.0	7.94
A9018.0	–	8.00	0.3150	75.0	117.0	8.00
A9018.1	–	8.10	0.3189	75.0	117.0	8.10
A9018.2	–	8.20	0.3228	75.0	117.0	8.20
A9018.3	–	8.30	0.3268	75.0	117.0	8.30
A90121/64	21/64	8.33	0.3281	84.0	117.0	8.33
A9018.4	–	8.40	0.3307	75.0	117.0	8.40
A9018.5	–	8.50	0.3346	75.0	117.0	8.50
A9018.6	–	8.60	0.3386	81.0	125.0	8.60
A9018.7	–	8.70	0.3425	81.0	125.0	8.70
A90111/32	11/32	8.73	0.3438	87.0	121.0	8.73
A9018.8	–	8.80	0.3465	81.0	125.0	8.80
A9018.9	–	8.90	0.3504	81.0	125.0	8.90
A9019.0	–	9.00	0.3543	81.0	125.0	9.00
A9019.1	–	9.10	0.3583	81.0	125.0	9.10

Producto	DC	DC	DC	LCF	OAL	DCON MS
	(inch)	(mm)	(inch)	(mm)	(mm)	(mm)
A90123/64	23/64	9.13	0.3594	89.0	124.0	9.13
A9019.2	–	9.20	0.3622	81.0	125.0	9.20
A9019.3	–	9.30	0.3661	81.0	125.0	9.30
A9019.4	–	9.40	0.3701	81.0	125.0	9.40
A9019.5	–	9.50	0.3740	81.0	125.0	9.50
A9013/8	3/8	9.52	0.3750	92.0	127.0	9.52
A9019.6	–	9.60	0.3780	87.0	133.0	9.60
A9019.7	–	9.70	0.3819	87.0	133.0	9.70
A9019.8	–	9.80	0.3858	87.0	133.0	9.80
A9019.9	–	9.90	0.3898	87.0	133.0	9.90
A90125/64	25/64	9.92	0.3906	95.0	130.0	9.92
A90110.0	–	10.00	0.3937	87.0	133.0	10.00
A90110.2	–	10.20	0.4016	87.0	133.0	10.20
A90110.3	–	10.30	0.4055	87.0	133.0	10.30
A90113/32	13/32	10.32	0.4063	98.0	133.0	10.32
A90110.4	–	10.40	0.4094	87.0	133.0	10.40
A90110.5	–	10.50	0.4134	87.0	133.0	10.50
A90127/64	27/64	10.72	0.4219	100.0	137.0	10.72
A90110.8	–	10.80	0.4252	94.0	142.0	10.80
A90111.0	–	11.00	0.4331	94.0	142.0	11.00
A9017/16	7/16	11.11	0.4375	103.0	140.0	11.11
A90111.5	–	11.50	0.4528	94.0	142.0	11.50
A90129/64	29/64	11.51	0.4531	106.0	143.0	11.51
A90111.8	–	11.80	0.4646	94.0	142.0	11.80
A90115/32	15/32	11.91	0.4688	110.0	146.0	11.91
A90112.0	–	12.00	0.4724	101.0	151.0	12.00
A90131/64	31/64	12.30	0.4844	111.0	149.0	12.30
A90112.5	–	12.50	0.4921	101.0	151.0	12.50
A9011/2	1/2	12.70	0.5000	101.0	151.0	12.70
A90113.0	–	13.00	0.5118	101.0	151.0	13.00
A90133/64	33/64	13.10	0.5156	122.0	168.0	13.10
A90113.5	–	13.50	0.5315	108.0	160.0	13.50
A90135/64	35/64	13.89	0.5469	122.0	168.0	13.89
A90114.0	–	14.00	0.5512	108.0	160.0	14.00
A9019/16	9/16	14.29	0.5625	122.0	168.0	14.29
A90114.5	–	14.50	0.5709	114.0	169.0	14.50
A90137/64	37/64	14.68	0.5781	122.0	168.0	14.68
A90115.0	–	15.00	0.5906	114.0	169.0	15.00
A90119/32	19/32	15.08	0.5938	132.0	181.0	15.08
A90139/64	39/64	15.48	0.6094	132.0	181.0	15.48
A90115.5	–	15.50	0.6102	120.0	178.0	15.50
A9015/8	5/8	15.88	0.6250	132.0	181.0	15.88
A90116.0	–	16.00	0.6299	120.0	178.0	16.00



A170



Broca HSS de Mango Rebajado, con Acabado Templado al Vapor

El mango cilíndrico de 1/2 pulgada permite a esta broca, incluso en diámetros grandes, ser montada en una máquina manual. La punta a 118° facilita el afilado. La superficie templada al vapor actúa reteniendo el fluido de corte y evitando que la viruta se suelde a la herramienta.

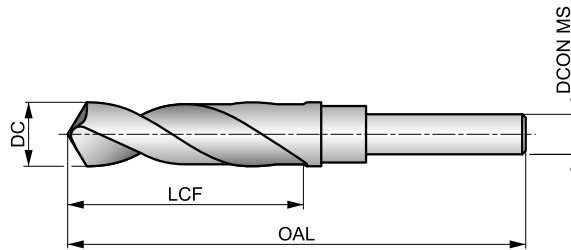

HSS	DORMER	4xD
118°	ST	
λ 20-35°	R	DC h8

Grupo de Material de la pieza adecuado y condiciones de velocidad de corte iniciales (m/min) y código de avance alfabético. Tablas con avance por revolución a partir de la pag.175.

P1.1 ■ 33 H	P1.2 ■ 37 H	P1.3 ■ 38 H	P2.1 ■ 28 H	P2.2 ■ 25 F	P2.3 ■ 22 D	P3.1 ■ 19 E	P3.2 ■ 15 E	P3.3 ■ 13 D	P4.1 ■ 11 E	P4.2 ■ 10 D	P4.3 ■ 8 C	M1.1 ■ 21 D	M1.2 ■ 17 D
M2.1 ■ 18 D	M2.2 ■ 15 D	M3.1 ■ 8 F	M3.2 ■ 7 F	M3.3 ■ 6 F	M4.1 ■ 7 B	K1.1 ■ 27 H	K1.2 ■ 20 E	K1.3 ■ 15 E	K2.1 ■ 23 D	K2.2 ■ 19 D	K2.3 ■ 15 D	K3.1 ■ 21 D	K3.2 ■ 16 D
K3.3 ■ 13 D	K4.1 ■ 19 D	K4.2 ■ 14 D	K4.3 ■ 11 D	K4.4 ■ 19 D	K4.5 ■ 8 D	K5.1 ■ 22 D	K5.2 ■ 16 D	K5.3 ■ 13 D	N1.1 ■ 33 I	N1.2 ■ 25 I	N1.3 ■ 17 H	N2.1 ■ 42 G	N2.2 ■ 37 G
N2.3 ■ 27 G	N3.1 ■ 56 G	N3.2 ■ 33 H	N3.3 ■ 17 F	N4.1 ■ 30 I	N4.2 ■ 28 G	N4.3 ■ 14 E	S1.1 ■ 17 E	S1.2 ■ 9 C	S1.3 ■ 5 A	S2.1 ■ 5 D	S2.2 ■ 4 A	S3.1 ■ 4 D	S3.2 ■ 3 A
S4.1 ■ 3 D	S4.2 ■ 2 A												

Producto	DC (inch)	DC (mm)	DC (inch)	LCF (inch)	OAL (inch)	LCF (mm)	OAL (mm)	DCON MS (mm)
A17013.0	-	13.00	0.5118	-	-	83.0	156.0	12,7
A17033/64	33/64	13.10	0.5156	3.1/8	6"	-	-	12,7
A17017/32	17/32	13.49	0.5313	3.1/8	6"	-	-	12,7
A17013.5	-	13.50	0.5315	-	-	83.0	156.0	12,7
A17035/64	35/64	13.89	0.5469	3.1/8	6"	-	-	12,7
A17014.0	-	14.00	0.5512	-	-	83.0	156.0	12,7
A1709/16	9/16	14.29	0.5625	3.1/8	6"	-	-	12,7
A17014.5	-	14.50	0.5709	-	-	83.0	156.0	12,7
A17037/64	37/64	14.68	0.5781	3.1/8	6"	-	-	12,7
A17015.0	-	15.00	0.5906	-	-	83.0	156.0	12,7
A17019/32	19/32	15.08	0.5938	3.1/8	6"	-	-	12,7
A17039/64	39/64	15.48	0.6094	3.1/8	6"	-	-	12,7
A17015.5	-	15.50	0.6102	-	-	83.0	156.0	12,7
A1705/8	5/8	15.88	0.6250	3.1/8	6"	-	-	12,7
A17016.0	-	16.00	0.6299	-	-	84.0	157.0	12,7
A17041/64	41/64	16.27	0.6406	3.1/8	6"	-	-	12,7
A17016.5	-	16.50	0.6496	-	-	84.0	157.0	12,7
A17021/32	21/32	16.67	0.6563	3.1/8	6"	-	-	12,7
A17017.0	-	17.00	0.6693	-	-	84.0	157.0	12,7
A17043/64	43/64	17.07	0.6719	3.1/8	6"	-	-	12,7
A17011/16	11/16	17.46	0.6875	3.1/8	6"	-	-	12,7
A17017.5	-	17.50	0.6890	-	-	84.0	157.0	12,7
A17045/64	45/64	17.86	0.7031	3.1/8	6"	-	-	12,7
A17018.0	-	18.00	0.7087	-	-	84.0	157.0	12,7



Producto	DC	DC	DC	LCF	OAL	LCF	OAL	DCON MS
	(inch)	(mm)	(inch)	(inch)	(inch)	(mm)	(mm)	(mm)
A17023/32	23/32	18.26	0.7188	3.1/8	6"	—	—	12,7
A17018.5	—	18.50	0.7283	—	—	84.0	157.0	12,7
A17047/64	47/64	18.65	0.7344	3.1/8	6"	—	—	12,7
A17019.0	—	19.00	0.7480	—	—	84.0	157.0	12,7
A1703/4	3/4	19.05	0.7500	3.1/8	6"	—	—	12,7
A17049/64	49/64	19.45	0.7656	3"	6"	—	—	12,7
A17019.5	—	19.50	0.7677	—	—	81.0	158.0	12,7
A17025/32	25/32	19.84	0.7813	3"	6"	—	—	12,7
A17020.0	—	20.00	0.7874	—	—	81.0	158.0	12,7
A17051/64	51/64	20.24	0.7969	3"	6"	—	—	12,7
A17013/16	13/16	20.64	0.8125	3"	6"	—	—	12,7
A17021.0	—	21.00	0.8268	—	—	82.0	158.0	12,7
A17053/64	53/64	21.03	0.8281	3"	6"	—	—	12,7
A17027/32	27/32	21.43	0.8437	3"	6"	—	—	12,7
A17055/64	55/64	21.83	0.8594	3"	6"	—	—	12,7
A17022.0	—	22.00	0.8661	—	—	82.0	158.0	12,7
A1707/8	7/8	22.22	0.8750	3"	6"	—	—	12,7
A17057/64	57/64	22.62	0.8906	3"	6"	—	—	12,7
A17023.0	—	23.00	0.9055	—	—	82.0	158.0	12,7
A17029/32	29/32	23.02	0.9063	3"	6"	—	—	12,7
A17059/64	59/64	23.42	0.9219	3"	6"	—	—	12,7
A17015/16	15/16	23.81	0.9375	3"	6"	—	—	12,7
A17024.0	—	24.00	0.9449	—	—	83.0	159.0	12,7
A17061/64	61/64	24.21	0.9531	3"	6"	—	—	12,7
A17031/32	31/32	24.61	0.9688	3"	6"	—	—	12,7
A17025.0	—	25.00	0.9843	—	—	83.0	159.0	12,7
A17063/64	63/64	25.00	0.9844	3"	6"	—	—	12,7
A1701	1"	25.40	1.0000	3"	6"	—	—	12,7
A1701.1/32	1.1/32	26.19	1.0313	3"	6"	—	—	12,7
A1701.1/16	1.1/16	26.99	1.0625	3"	6"	—	—	12,7
A1701.7/64	1.7/64	28.18	1.1094	3"	6"	—	—	12,7
A1701.1/8	1.1/8	28.58	1.1250	3"	6"	—	—	12,7
A1701.9/64	1.9/64	28.97	1.1406	3"	6"	—	—	12,7
A1701.5/32	1.5/32	29.37	1.1563	3"	6"	—	—	12,7
A1701.3/16	1.3/16	30.16	1.1875	3"	6"	—	—	12,7
A1701.7/32	1.7/32	30.96	1.2188	3"	6"	—	—	12,7
A1701.1/4	1.1/4	31.75	1.2500	3"	6"	—	—	12,7
A1701.5/16	1.5/16	33.34	1.3125	3"	6"	—	—	12,7
A1701.3/8	1.3/8	34.93	1.3750	3"	6"	—	—	12,7
A1701.7/16	1.7/16	36.51	1.4375	3"	6"	—	—	12,7
A1701.1/2	1.1/2	38.10	1.5000	3"	6"	—	—	12,7



A243



Broca HSS, Mango Largo para Aeronáutica, Acabado Brillante

Broca según norma NAS907 con punta dividida a 135° que favorece el auto-centrado, evitando que la punta de la broca se deslice sobre la superficie del material. La longitud total larga combinada con una longitud de canales corta la hace ideal para taladrar en áreas de difícil acceso y es adecuado para muchos materiales.

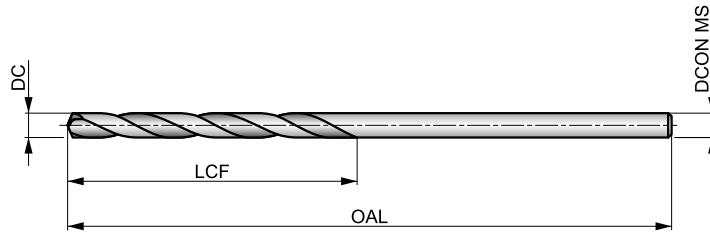

HSS	NAS 907	4xD
135°	Bright	
λ 20-35°	R	DC h8

Grupo de Material de la pieza adecuado y condiciones de velocidad de corte iniciales (m/min) y código de avance alfabético. Tablas con avance por revolución a partir de la pag.175.

P2.2 ■ 25 F	P2.3 ■ 22 E	P3.1 ■ 19 F	P3.2 ■ 15 F	P3.3 ■ 13 E	P4.1 ■ 11 F	P4.2 ■ 10 E	P4.3 ■ 8 D	M1.1 ■ 21 E	M1.2 ■ 17 E	M2.1 ■ 18 E	M2.2 ■ 15 E	M3.1 ■ 9 G	M3.2 ■ 8 G
M3.3 ■ 7 G	M4.1 ■ 9 C	K1.1 ■ 30 I	K1.2 ■ 22 F	K1.3 ■ 17 F	K2.1 ■ 25 E	K2.2 ■ 20 E	K2.3 ■ 16 E	K3.1 ■ 22 E	K3.2 ■ 17 E	K3.3 ■ 13 E	K4.1 ■ 20 E	K4.2 ■ 15 E	K4.3 ■ 11 E
K4.4 ■ 10 E	K4.5 ■ 8 E	K5.1 ■ 23 E	K5.2 ■ 17 E	K5.3 ■ 13 E	N3.1 ■ 27 H	S1.1 ■ 23 F	S1.2 ■ 12 D	S1.3 ■ 6 B	S2.1 ■ 8 E	S2.2 ■ 4 A	S3.1 ■ 6 E	S3.2 ■ 3 A	S4.1 ■ 5 E
S4.2 ■ 2 A													

6" OAL.

Producto	DC (inch)	DC (inch)	LCF (inch)	OAL (inch)	DCON MS (inch)
A2433/32X6	3/32	0.0938	1.1/4	6"	0.0938
A243N40X6	N40	0.0980	1.3/8	6"	0.0980
A2431/8X6	1/8	0.1250	1.5/8	6"	0.1250
A243N30X6	N30	0.1285	1.5/8	6"	0.1285
A2435/32X6	5/32	0.1563	2"	6"	0.1563
A243N21X6	N21	0.1590	2.1/8	6"	0.1590

Producto	DC (inch)	DC (inch)	LCF (inch)	OAL (inch)	DCON MS (inch)
A243N20X6	N20	0.1610	2.1/8	6"	0.1610
A2433/16X6	3/16	0.1875	2.5/16	6"	0.1875
A243N11X6	N11	0.1910	2.5/16	6"	0.1910
A243N10X6	N10	0.1935	2.7/16	6"	0.1935
A2431/4X6	1/4	0.2500	2.3/4	6"	0.2500



A244



Broca HSS, Mango Largo para Aeronáutica, Acabado Brillante

Broca según norma NAS907 con punta dividida a 118° que favorece el autocentrado, evitando que la punta de la broca se deslice sobre la superficie del material. La longitud total larga combinada con una longitud de canales corta la hace ideal para taladrar en áreas de difícil acceso y es adecuado para muchos materiales.

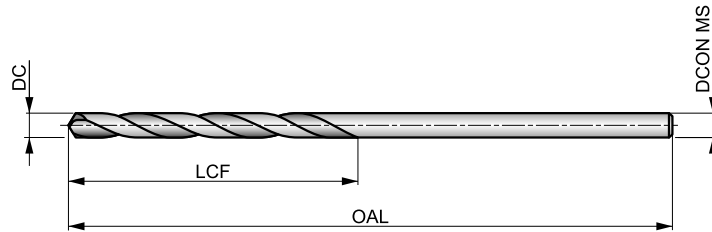

HSS	NAS 907	4xD
118°	Bright	
λ 20-35°	R	DC h8

Grupo de Material de la pieza adecuado y condiciones de velocidad de corte iniciales (m/min) y código de avance alfabético. Tablas con avance por revolución a partir de la pag.175.

P2.2 ■ 25 F	P2.3 ■ 22 E	P3.1 ■ 19 F	P3.2 ■ 15 F	P3.3 ■ 13 E	P4.1 ■ 11 F	P4.2 ■ 10 E	P4.3 ■ 8 D	M1.1 ■ 21 E	M1.2 ■ 17 E	M2.1 ■ 18 E	M2.2 ■ 15 E	M3.1 ■ 9 G	M3.2 ■ 8 G
M3.3 ■ 7 G	M4.1 ■ 9 C	K1.1 ■ 30 I	K1.2 ■ 22 F	K1.3 ■ 17 F	K2.1 ■ 25 E	K2.2 ■ 20 E	K2.3 ■ 16 E	K3.1 ■ 22 E	K3.2 ■ 17 E	K3.3 ■ 13 E	K4.1 ■ 20 E	K4.2 ■ 15 E	K4.3 ■ 11 E
K4.4 ■ 10 E	K4.5 ■ 8 E	K5.1 ■ 23 E	K5.2 ■ 17 E	K5.3 ■ 13 E	N3.1 ■ 27 H	S1.1 ■ 23 F	S1.2 ■ 12 D	S1.3 ■ 6 B	S2.1 ■ 8 E	S2.2 ■ 4 A	S3.1 ■ 6 E	S3.2 ■ 3 A	S4.1 ■ 5 E
S4.2 ■ 2 A													

6°OAL.

Producto	DC (inch)	DC (inch)	LCF (inch)	OAL (inch)	DCON MS (inch)
A2441/8X6	1/8	0.1250	1.5/8	6"	0.1250
A2445/32X6	5/32	0.1563	2"	6"	0.1563
A2443/16X6	3/16	0.1875	2.5/16	6"	0.1875
A2441/4X6	1/4	0.2500	2.3/4	6"	0.2500



A110



Broca HSS Serie Larga, con Acabado Templado al Vapor

Para taladrar agujeros más profundos. La punta convencional a 118° proporciona resistencia y es fácil de reafilarse, lo que la hace muy rentable. Adecuado para taladrar muchos materiales. El acabado templado al vapor retiene el fluido de corte y evita la soldadura de la viruta a la herramienta. Para taladrados manuales y máquinas.

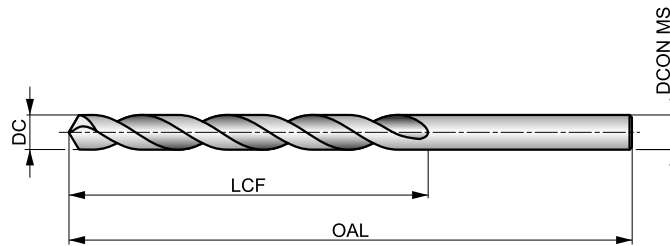

HSS	DIN 340	6xD
118°	ST	
λ 20-35°	R	DC h8

Grupo de Material de la pieza adecuado y condiciones de velocidad de corte iniciales (m/min) y código de avance alfabético. Tablas con avance por revolución a partir de la pag.175.

P1.1 ■ 27 G	P1.2 ■ 30 G	P1.3 ■ 31 G	P2.1 ■ 23 G	P2.2 ■ 20 E	P2.3 ■ 18 D	P3.1 ■ 13 E	P3.2 ■ 11 E	P3.3 ■ 9 D	P4.1 ■ 8 E	P4.2 ■ 7 D	P4.3 ■ 5 B	M1.1 ■ 14 D	M1.2 ■ 12 D
M2.1 ■ 12 D	M2.2 ■ 10 D	M3.1 ■ 7 F	M3.2 ■ 6 F	M3.3 ■ 5 F	M4.1 ■ 4 B	K1.1 ■ 28 H	K1.2 ■ 21 E	K1.3 ■ 16 E	K2.1 ■ 18 D	K2.2 ■ 15 D	K2.3 ■ 12 D	K3.1 ■ 16 D	K3.2 ■ 12 D
K3.3 ■ 10 D	K4.1 ■ 15 D	K4.2 ■ 11 D	K4.3 ■ 8 D	K4.4 ■ 7 D	K4.5 ■ 6 D	K5.1 ■ 17 D	K5.2 ■ 13 D	K5.3 ■ 10 D	N1.1 ■ 32 I	N1.2 ■ 24 I	N1.3 ■ 16 H	N2.1 ■ 42 G	N2.2 ■ 37 G
N2.3 ■ 27 G	N3.1 ■ 54 G	N3.2 ■ 32 H	N3.3 ■ 16 E	N4.1 ■ 35 I	N4.2 ■ 26 G	N4.3 ■ 12 E	S1.1 ■ 17 E	S1.2 ■ 9 C	S1.3 ■ 4 A	S2.1 ■ 5 D	S2.2 ■ 4 A	S3.1 ■ 4 D	S3.2 ■ 3 A
S4.1 ■ 3 D	S4.2 ■ 2 A												

DC <= 1mm; 1/16" Brillante

Producto	DC (inch)	DC (mm)	DC (inch)	LCF (mm)	OAL (mm)	DCON MS (mm)
A110.5	-	0.50	0.0197	12.0	32.0	0.50
A110.6	-	0.60	0.0236	15.0	35.0	0.60
A110.7	-	0.70	0.0276	21.0	42.0	0.70
A1101/32	1/32	0.79	0.0313	25.0	46.0	0.79
A110.8	-	0.80	0.0315	25.0	46.0	0.80
A110.9	-	0.90	0.0354	29.0	51.0	0.90
A1101.0	-	1.00	0.0394	33.0	56.0	1.00
A1101.1	-	1.10	0.0433	37.0	60.0	1.10
A1101.2	-	1.20	0.0472	41.0	65.0	1.20
A1101.3	-	1.30	0.0512	41.0	65.0	1.30
A1101.4	-	1.40	0.0551	45.0	70.0	1.40
A1101.5	-	1.50	0.0591	45.0	70.0	1.50
A1101/16	1/16	1.59	0.0625	50.0	76.0	1.59
A1101.6	-	1.60	0.0630	50.0	76.0	1.60
A1101.7	-	1.70	0.0669	50.0	76.0	1.70
A1101.75	-	1.75	0.0689	53.0	80.0	1.75
A1101.8	-	1.80	0.0709	53.0	80.0	1.80
A1101.9	-	1.90	0.0748	53.0	80.0	1.90
A1105/64	5/64	1.98	0.0781	56.0	85.0	1.98
A1102.0	-	2.00	0.0787	56.0	85.0	2.00
A1102.05	-	2.05	0.0807	56.0	85.0	2.05
A1102.1	-	2.10	0.0827	56.0	85.0	2.10
A1102.2	-	2.20	0.0866	59.0	90.0	2.20
A1102.25	-	2.25	0.0886	59.0	90.0	2.25

Producto	DC (inch)	DC (mm)	DC (inch)	LCF (mm)	OAL (mm)	DCON MS (mm)
A1102.3	-	2.30	0.0906	59.0	90.0	2.30
A1103/32	3/32	2.38	0.0938	62.0	95.0	2.38
A1102.4	-	2.40	0.0945	62.0	95.0	2.40
A1102.5	-	2.50	0.0984	62.0	95.0	2.50
A1102.6	-	2.60	0.1024	62.0	95.0	2.60
A1102.7	-	2.70	0.1063	66.0	100.0	2.70
A1107/64	7/64	2.78	0.1094	66.0	100.0	2.78
A1102.8	-	2.80	0.1102	66.0	100.0	2.80
A1102.9	-	2.90	0.1142	66.0	100.0	2.90
A1103.0	-	3.00	0.1181	66.0	100.0	3.00
A1103.1	-	3.10	0.1220	69.0	106.0	3.10
A1101/8	1/8	3.18	0.1250	69.0	106.0	3.18
A1103.2	-	3.20	0.1260	69.0	106.0	3.20
A1103.25	-	3.25	0.1280	69.0	106.0	3.25
A1103.3	-	3.30	0.1299	69.0	106.0	3.30
A1103.4	-	3.40	0.1339	73.0	112.0	3.40
A1103.5	-	3.50	0.1378	73.0	112.0	3.50
A1109/64	9/64	3.57	0.1406	73.0	112.0	3.57
A1103.6	-	3.60	0.1417	73.0	112.0	3.60
A1103.7	-	3.70	0.1457	73.0	112.0	3.70
A1103.75	-	3.75	0.1476	73.0	112.0	3.75
A1103.8	-	3.80	0.1496	78.0	119.0	3.80
A1103.9	-	3.90	0.1535	78.0	119.0	3.90
A1105/32	5/32	3.97	0.1563	78.0	119.0	3.97



Producto	DC	DC	DC	LCF	OAL	DCON MS
	(inch)	(mm)	(inch)	(mm)	(mm)	(mm)
A1104.0	-	4.00	0.1575	78.0	119.0	4.00
A1104.1	-	4.10	0.1614	78.0	119.0	4.10
A1104.2	-	4.20	0.1654	78.0	119.0	4.20
A1104.25	-	4.25	0.1673	78.0	119.0	4.25
A1104.3	-	4.30	0.1693	82.0	126.0	4.30
A11011/64	11/64	4.37	0.1719	82.0	126.0	4.37
A1104.4	-	4.40	0.1732	82.0	126.0	4.40
A1104.5	-	4.50	0.1772	82.0	126.0	4.50
A1104.6	-	4.60	0.1811	82.0	126.0	4.60
A1104.7	-	4.70	0.1850	82.0	126.0	4.70
A1104.75	-	4.75	0.1870	82.0	126.0	4.75
A1103/16	3/16	4.76	0.1875	87.0	132.0	4.76
A1104.8	-	4.80	0.1890	87.0	132.0	4.80
A1104.9	-	4.90	0.1929	87.0	132.0	4.90
A1105.0	-	5.00	0.1969	87.0	132.0	5.00
A1105.1	-	5.10	0.2008	87.0	132.0	5.10
A11013/64	13/64	5.16	0.2031	87.0	132.0	5.16
A1105.2	-	5.20	0.2047	87.0	132.0	5.20
A1105.25	-	5.25	0.2067	87.0	132.0	5.25
A1105.3	-	5.30	0.2087	87.0	132.0	5.30
A1105.4	-	5.40	0.2126	91.0	139.0	5.40
A1105.5	-	5.50	0.2165	91.0	139.0	5.50
A1107/32	7/32	5.56	0.2188	91.0	139.0	5.56
A1105.6	-	5.60	0.2205	91.0	139.0	5.60
A1105.7	-	5.70	0.2244	91.0	139.0	5.70
A1105.75	-	5.75	0.2264	91.0	139.0	5.75
A1105.8	-	5.80	0.2283	91.0	139.0	5.80
A1105.9	-	5.90	0.2323	91.0	139.0	5.90
A11015/64	15/64	5.95	0.2344	91.0	139.0	5.95
A1106.0	-	6.00	0.2362	91.0	139.0	6.00
A1106.1	-	6.10	0.2402	97.0	148.0	6.10
A1106.2	-	6.20	0.2441	97.0	148.0	6.20
A1106.25	-	6.25	0.2461	97.0	148.0	6.25
A1106.3	-	6.30	0.2480	97.0	148.0	6.30
A1101/4	1/4	6.35	0.2500	97.0	148.0	6.35
A1106.4	-	6.40	0.2520	97.0	148.0	6.40
A1106.5	-	6.50	0.2559	97.0	148.0	6.50
A1106.6	-	6.60	0.2598	97.0	148.0	6.60
A1106.7	-	6.70	0.2638	97.0	148.0	6.70
A11017/64	17/64	6.75	0.2656	102.0	156.0	6.75
A1106.75	-	6.75	0.2657	102.0	156.0	6.75
A1106.8	-	6.80	0.2677	102.0	156.0	6.80
A1106.9	-	6.90	0.2717	102.0	156.0	6.90
A1107.0	-	7.00	0.2756	102.0	156.0	7.00
A1107.1	-	7.10	0.2795	102.0	156.0	7.10
A1109/32	9/32	7.14	0.2813	102.0	156.0	7.14
A1107.2	-	7.20	0.2835	102.0	156.0	7.20
A1107.25	-	7.25	0.2854	102.0	156.0	7.25
A1107.3	-	7.30	0.2874	102.0	156.0	7.30
A1107.4	-	7.40	0.2913	102.0	156.0	7.40
A1107.5	-	7.50	0.2953	102.0	156.0	7.50
A1107.6	-	7.60	0.2992	109.0	165.0	7.60
A1107.7	-	7.70	0.3031	109.0	165.0	7.70
A1107.75	-	7.75	0.3051	109.0	165.0	7.75
A1107.8	-	7.80	0.3071	109.0	165.0	7.80
A1107.9	-	7.90	0.3110	109.0	165.0	7.90
A1105/16	5/16	7.94	0.3125	109.0	165.0	7.94
A1108.0	-	8.00	0.3150	109.0	165.0	8.00
A1108.1	-	8.10	0.3189	109.0	165.0	8.10
A1108.2	-	8.20	0.3228	109.0	165.0	8.20
A1108.25	-	8.25	0.3248	109.0	165.0	8.25
A1108.3	-	8.30	0.3268	109.0	165.0	8.30
A1108.4	-	8.40	0.3307	109.0	165.0	8.40
A1108.5	-	8.50	0.3346	109.0	165.0	8.50
A1108.6	-	8.60	0.3386	115.0	175.0	8.60

Producto	DC	DC	DC	LCF	OAL	DCON MS
	(inch)	(mm)	(inch)	(mm)	(mm)	(mm)
A1108.7	-	8.70	0.3425	115.0	175.0	8.70
A11011/32	11/32	8.73	0.3438	115.0	175.0	8.73
A1108.75	-	8.75	0.3445	115.0	175.0	8.75
A1108.8	-	8.80	0.3465	115.0	175.0	8.80
A1108.9	-	8.90	0.3504	115.0	175.0	8.90
A1109.0	-	9.00	0.3543	115.0	175.0	9.00
A1109.1	-	9.10	0.3583	115.0	175.0	9.10
A1109.2	-	9.20	0.3622	115.0	175.0	9.20
A1109.25	-	9.25	0.3642	115.0	175.0	9.25
A1109.3	-	9.30	0.3661	115.0	175.0	9.30
A1109.4	-	9.40	0.3701	115.0	175.0	9.40
A1109.5	-	9.50	0.3740	115.0	175.0	9.50
A1103/8	3/8	9.52	0.3750	121.0	184.0	9.52
A1109.6	-	9.60	0.3780	121.0	184.0	9.60
A1109.7	-	9.70	0.3819	121.0	184.0	9.70
A1109.75	-	9.75	0.3839	121.0	184.0	9.75
A1109.8	-	9.80	0.3858	121.0	184.0	9.80
A1109.9	-	9.90	0.3898	121.0	184.0	9.90
A11010.0	-	10.00	0.3937	121.0	184.0	10.00
A11010.1	-	10.10	0.3976	121.0	184.0	10.10
A11010.2	-	10.20	0.4016	121.0	184.0	10.20
A11010.25	-	10.25	0.4035	121.0	184.0	10.25
A11010.3	-	10.30	0.4055	121.0	184.0	10.30
A11013/32	13/32	10.32	0.4063	121.0	184.0	10.32
A11010.5	-	10.50	0.4134	121.0	184.0	10.50
A11010.75	-	10.75	0.4232	128.0	195.0	10.75
A11010.8	-	10.80	0.4252	128.0	195.0	10.80
A11011.0	-	11.00	0.4331	128.0	195.0	11.00
A1107/16	7/16	11.11	0.4375	128.0	195.0	11.11
A11011.25	-	11.25	0.4429	128.0	195.0	11.25
A11011.4	-	11.40	0.4488	128.0	195.0	11.40
A11011.5	-	11.50	0.4528	128.0	195.0	11.50
A11011.75	-	11.75	0.4626	128.0	195.0	11.75
A11012.0	-	12.00	0.4724	134.0	205.0	12.00
A11012.1	-	12.10	0.4764	134.0	205.0	12.10
A11012.25	-	12.25	0.4823	134.0	205.0	12.25
A11012.5	-	12.50	0.4921	134.0	205.0	12.50
A1101/2	1/2	12.70	0.5000	134.0	205.0	12.70
A11013.0	-	13.00	0.5118	134.0	205.0	13.00
A11017/32	17/32	13.49	0.5313	140.0	214.0	13.49
A11013.5	-	13.50	0.5315	140.0	214.0	13.50
A11014.0	-	14.00	0.5512	140.0	214.0	14.00
A1109/16	9/16	14.29	0.5625	144.0	220.0	14.29
A11014.5	-	14.50	0.5709	144.0	220.0	14.50
A11015.0	-	15.00	0.5906	144.0	220.0	15.00
A11015.5	-	15.50	0.6102	149.0	227.0	15.50
A1105/8	5/8	15.88	0.6250	149.0	227.0	15.88
A11016.0	-	16.00	0.6299	149.0	227.0	16.00
A11016.5	-	16.50	0.6496	154.0	235.0	16.50
A11017.0	-	17.00	0.6693	154.0	235.0	17.00
A11011/16	11/16	17.46	0.6875	158.0	241.0	17.46
A11017.5	-	17.50	0.6890	158.0	241.0	17.50
A11018.0	-	18.00	0.7087	158.0	241.0	18.00
A11018.5	-	18.50	0.7283	162.0	247.0	18.50
A11019.0	-	19.00	0.7480	162.0	247.0	19.00
A1103/4	3/4	19.05	0.7500	166.0	254.0	19.05
A11019.5	-	19.50	0.7677	166.0	254.0	19.50
A11020.0	-	20.00	0.7874	166.0	254.0	20.00
A11021.0	-	21.00	0.8268	171.0	261.0	21.00
A11022.0	-	22.00	0.8661	176.0	268.0	22.00
A1107/8	7/8	22.22	0.8750	176.0	268.0	22.22
A11015/16	15/16	23.81	0.9375	185.0	282.0	23.81
A1101	1"	25.40	1.0000	190.0	290.0	25.40



A940



Broca PFX HSS-E (5% Cobalto), Serie Larga, Acabo Brillante

Broca de alto rendimiento, capaz de producir agujeros precisos y de alta calidad a altas velocidades y avances (tolerancia de agujero H10). La punta autocentrante a 130° y el diseño especial parabólico de los canales ayudan a taladrar agujeros profundos en una sola pasada. Apta para la mayoría de materiales.

PFX

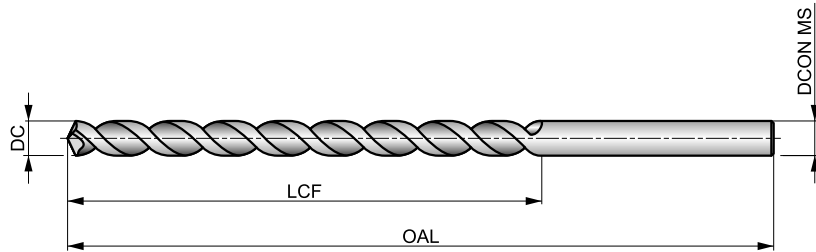

HSS-E	DIN ANSI	10xD
130°	Bright	
λ>35°	R	DC h8

Grupo de Material de la pieza adecuado y condiciones de velocidad de corte iniciales (m/min) y código de avance alfabético. Tablas con avance por revolución a partir de la pag.175.

P1.1 ■ 29 F	P1.2 ■ 33 F	P1.3 ■ 34 F	P2.1 ■ 25 F	P2.2 ■ 22 G	P2.3 ■ 19 C	P3.1 ■ 25 G	P3.2 ■ 20 G	P3.3 ■ 17 C	P4.1 ■ 15 G	P4.2 ■ 13 C	P4.3 ■ 10 C	M1.1 ■ 21 C	M1.2 ■ 17 C
M2.1 ■ 18 C	M2.2 ■ 15 C	M3.1 ■ 8 E	M3.2 ■ 7 E	M3.3 ■ 6 E	M4.1 ■ 9 B	K2.1 ■ 20 I	K2.2 ■ 16 I	K2.3 ■ 13 H	K3.1 ■ 17 I	K3.2 ■ 13 I	K3.3 ■ 11 H	K4.1 ■ 16 I	K4.2 ■ 12 I
K4.3 ■ 9 H	K4.4 ■ 8 H	K4.5 ■ 6 H	K5.1 ■ 18 I	K5.2 ■ 14 I	K5.3 ■ 11 H	N1.1 ■ 53 H	N1.2 ■ 40 H	N1.3 ■ 27 N	N2.1 ■ 62 N	N2.2 ■ 55 N	N2.3 ■ 40 N	N3.1 ■ 119 G	N3.2 ■ 70 F
N3.3 ■ 35 F	N4.1 ■ 55 H	N4.2 ■ 40 F	S1.1 ■ 18 E	S1.2 ■ 13 C	S1.3 ■ 6 C								

DC >= 9.6mm menos de 10xD.

Producto	DC (inch)	DC (mm)	DC (inch)	LCF (mm)	OAL (mm)	DCON MS (mm)
A9401.0	-	1.00	0.0394	33.0	56.0	1.00
A9401.1	-	1.10	0.0433	37.0	60.0	1.10
A9403/64	3/64	1.19	0.0469	29.0	57.0	1.19
A9401.2	-	1.20	0.0472	41.0	65.0	1.20
A9401.3	-	1.30	0.0512	41.0	65.0	1.30
A9401.4	-	1.40	0.0551	45.0	70.0	1.40
A9401.5	-	1.50	0.0591	45.0	70.0	1.50
A9401/16	1/16	1.59	0.0625	44.0	76.0	1.59
A9401.6	-	1.60	0.0630	50.0	76.0	1.60
A9401.7	-	1.70	0.0669	50.0	76.0	1.70
A9401.8	-	1.80	0.0709	53.0	80.0	1.80
A9401.9	-	1.90	0.0748	53.0	80.0	1.90
A9405/64	5/64	1.98	0.0781	51.0	95.0	1.98
A9402.0	-	2.00	0.0787	56.0	85.0	2.00
A9402.1	-	2.10	0.0827	56.0	85.0	2.10
A9402.2	-	2.20	0.0866	59.0	90.0	2.20
A9402.3	-	2.30	0.0906	59.0	90.0	2.30
A9403/32	3/32	2.38	0.0938	57.0	108.0	2.38
A9402.4	-	2.40	0.0945	62.0	95.0	2.40
A9402.5	-	2.50	0.0984	62.0	95.0	2.50
A9402.6	-	2.60	0.1024	62.0	95.0	2.60
A9402.7	-	2.70	0.1063	66.0	100.0	2.70
A9407/64	7/64	2.78	0.1094	64.0	117.0	2.78
A9402.8	-	2.80	0.1102	66.0	100.0	2.80
A9402.9	-	2.90	0.1142	66.0	100.0	2.90

Producto	DC (inch)	DC (mm)	DC (inch)	LCF (mm)	OAL (mm)	DCON MS (mm)
A9403.0	-	3.00	0.1181	66.0	100.0	3.00
A9403.1	-	3.10	0.1220	69.0	106.0	3.10
A9401/8	1/8	3.18	0.1250	70.0	130.0	3.18
A9403.2	-	3.20	0.1260	69.0	106.0	3.20
A9403.3	-	3.30	0.1299	69.0	106.0	3.30
A9403.4	-	3.40	0.1339	73.0	112.0	3.40
A9403.5	-	3.50	0.1378	73.0	112.0	3.50
A9409/64	9/64	3.57	0.1406	76.0	137.0	3.57
A9403.6	-	3.60	0.1417	73.0	112.0	3.60
A9403.7	-	3.70	0.1457	73.0	112.0	3.70
A9403.8	-	3.80	0.1496	78.0	119.0	3.80
A9403.9	-	3.90	0.1535	78.0	119.0	3.90
A9405/32	5/32	3.97	0.1563	76.0	137.0	3.97
A9404.0	-	4.00	0.1575	78.0	119.0	4.00
A9404.1	-	4.10	0.1614	78.0	119.0	4.10
A9404.2	-	4.20	0.1654	78.0	119.0	4.20
A9404.3	-	4.30	0.1693	82.0	126.0	4.30
A94011/64	11/64	4.37	0.1719	86.0	146.0	4.37
A9404.4	-	4.40	0.1732	82.0	126.0	4.40
A9404.5	-	4.50	0.1772	82.0	126.0	4.50
A9404.6	-	4.60	0.1811	82.0	126.0	4.60
A9404.7	-	4.70	0.1850	82.0	126.0	4.70
A9403/16	3/16	4.76	0.1875	86.0	146.0	4.76
A9404.8	-	4.80	0.1890	87.0	132.0	4.80
A9404.9	-	4.90	0.1929	87.0	132.0	4.90



Producto	DC	DC	DC	LCF	OAL	D CON MS
	(inch)	(mm)	(inch)	(mm)	(mm)	(mm)
A9405.0	–	5.00	0.1969	87.0	132.0	5.00
A9405.1	–	5.10	0.2008	87.0	132.0	5.10
A94013/64	13/64	5.16	0.2031	92.0	152.0	5.16
A9405.2	–	5.20	0.2047	87.0	132.0	5.20
A9405.3	–	5.30	0.2087	87.0	132.0	5.30
A9405.4	–	5.40	0.2126	91.0	139.0	5.40
A9405.5	–	5.50	0.2165	91.0	139.0	5.50
A9407/32	7/32	5.56	0.2188	92.0	152.0	5.56
A9405.6	–	5.60	0.2205	91.0	139.0	5.60
A9405.7	–	5.70	0.2244	91.0	139.0	5.70
A9405.8	–	5.80	0.2283	91.0	139.0	5.80
A9405.9	–	5.90	0.2323	91.0	139.0	5.90
A94015/64	15/64	5.95	0.2344	95.0	156.0	5.95
A9406.0	–	6.00	0.2362	91.0	139.0	6.00
A9406.1	–	6.10	0.2402	97.0	148.0	6.10
A9406.2	–	6.20	0.2441	97.0	148.0	6.20
A9406.3	–	6.30	0.2480	97.0	148.0	6.30
A9401/4	1/4	6.35	0.2500	95.0	156.0	6.35
A9406.4	–	6.40	0.2520	97.0	148.0	6.40
A9406.5	–	6.50	0.2559	97.0	148.0	6.50
A9406.6	–	6.60	0.2598	97.0	148.0	6.60
A9406.7	–	6.70	0.2638	97.0	148.0	6.70
A94017/64	17/64	6.75	0.2656	98.0	159.0	6.75
A9406.8	–	6.80	0.2677	102.0	156.0	6.80
A9406.9	–	6.90	0.2717	102.0	156.0	6.90
A9407.0	–	7.00	0.2756	102.0	156.0	7.00
A9407.1	–	7.10	0.2795	102.0	156.0	7.10
A9409/32	9/32	7.14	0.2813	98.0	159.0	7.14
A9407.2	–	7.20	0.2835	102.0	156.0	7.20
A9407.3	–	7.30	0.2874	102.0	156.0	7.30
A9407.4	–	7.40	0.2913	102.0	156.0	7.40
A9407.5	–	7.50	0.2953	102.0	156.0	7.50
A94019/64	19/64	7.54	0.2969	102.0	162.0	7.54
A9407.6	–	7.60	0.2992	109.0	165.0	7.60
A9407.7	–	7.70	0.3031	109.0	165.0	7.70
A9407.8	–	7.80	0.3071	109.0	165.0	7.80
A9407.9	–	7.90	0.3110	109.0	165.0	7.90
A9405/16	5/16	7.94	0.3125	102.0	162.0	7.94
A9408.0	–	8.00	0.3150	109.0	165.0	8.00
A9408.1	–	8.10	0.3189	109.0	165.0	8.10
A9408.2	–	8.20	0.3228	109.0	165.0	8.20
A9408.3	–	8.30	0.3268	109.0	165.0	8.30
A94021/64	21/64	8.33	0.3281	105.0	165.0	8.33
A9408.4	–	8.40	0.3307	109.0	165.0	8.40
A9408.5	–	8.50	0.3346	109.0	165.0	8.50
A9408.6	–	8.60	0.3386	115.0	175.0	8.60
A9408.7	–	8.70	0.3425	115.0	175.0	8.70
A94011/32	11/32	8.73	0.3438	105.0	165.0	8.73
A9408.8	–	8.80	0.3465	115.0	175.0	8.80
A9408.9	–	8.90	0.3504	115.0	175.0	8.90
A9409.0	–	9.00	0.3543	115.0	175.0	9.00
A9409.1	–	9.10	0.3583	115.0	175.0	9.10
A94023/64	23/64	9.13	0.3594	108.0	171.0	9.13
A9409.2	–	9.20	0.3622	115.0	175.0	9.20
A9409.3	–	9.30	0.3661	115.0	175.0	9.30
A9409.4	–	9.40	0.3701	115.0	175.0	9.40

Producto	DC	DC	DC	LCF	OAL	D CON MS
	(inch)	(mm)	(inch)	(mm)	(mm)	(mm)
A9409.5	–	9.50	0.3740	115.0	175.0	9.50
A9403/8	3/8	9.52	0.3750	108.0	171.0	9.52
A9409.6	–	9.60	0.3780	121.0	184.0	9.60
A9409.7	–	9.70	0.3819	121.0	184.0	9.70
A9409.8	–	9.80	0.3858	121.0	184.0	9.80
A9409.9	–	9.90	0.3898	121.0	184.0	9.90
A94025/64	25/64	9.92	0.3906	111.0	178.0	9.92
A94010.0	–	10.00	0.3937	121.0	184.0	10.00
A94010.2	–	10.20	0.4016	121.0	184.0	10.20
A94010.3	–	10.30	0.4055	121.0	184.0	10.30
A94013/32	13/32	10.32	0.4063	111.0	178.0	10.32
A94010.5	–	10.50	0.4134	121.0	184.0	10.50
A94027/64	27/64	10.72	0.4219	117.0	184.0	10.72
A94011.0	–	11.00	0.4331	128.0	195.0	11.00
A9407/16	7/16	11.11	0.4375	117.0	184.0	11.11
A94011.2	–	11.20	0.4409	128.0	195.0	11.20
A94011.5	–	11.50	0.4528	128.0	195.0	11.50
A94029/64	29/64	11.51	0.4531	121.0	190.0	11.51
A94011.8	–	11.80	0.4646	128.0	195.0	11.80
A94015/32	15/32	11.91	0.4688	121.0	190.0	11.91
A94012.0	–	12.00	0.4724	134.0	205.0	12.00
A94012.2	–	12.20	0.4803	134.0	205.0	12.20
A94031/64	31/64	12.30	0.4844	121.0	197.0	12.30
A94012.5	–	12.50	0.4921	134.0	205.0	12.50
A9401/2	1/2	12.70	0.5000	121.0	197.0	12.70
A94013.0	–	13.00	0.5118	134.0	205.0	13.00
A94033/64	33/64	13.10	0.5156	121.0	203.0	13.10
A94017/32	17/32	13.49	0.5313	121.0	203.0	13.49
A94013.5	–	13.50	0.5315	140.0	214.0	13.50
A94035/64	35/64	13.89	0.5469	124.0	210.0	13.89
A94014.0	–	14.00	0.5512	140.0	214.0	14.00
A9409/16	9/16	14.29	0.5625	124.0	210.0	14.29
A94014.5	–	14.50	0.5709	144.0	220.0	14.50
A94037/64	37/64	14.68	0.5781	124.0	222.0	14.68
A94015.0	–	15.00	0.5906	144.0	220.0	15.00
A94019/32	19/32	15.08	0.5938	124.0	222.0	15.08
A94039/64	39/64	15.48	0.6094	124.0	222.0	15.48
A94015.5	–	15.50	0.6102	149.0	227.0	15.50
A9405/8	5/8	15.88	0.6250	124.0	222.0	15.88
A94016.0	–	16.00	0.6299	149.0	227.0	16.00
A94041/64	41/64	16.27	0.6406	130.0	229.0	16.27
A94016.5	–	16.50	0.6496	154.0	235.0	16.50
A94021/32	21/32	16.67	0.6563	130.0	229.0	16.67
A94017.0	–	17.00	0.6693	154.0	235.0	17.00
A94043/64	43/64	17.07	0.6719	137.0	235.0	17.07
A94011/16	11/16	17.46	0.6875	137.0	235.0	17.46
A94017.5	–	17.50	0.6890	158.0	241.0	17.50
A94045/64	45/64	17.86	0.7031	143.0	241.0	17.86
A94018.0	–	18.00	0.7087	158.0	241.0	18.00
A94023/32	23/32	18.26	0.7188	143.0	241.0	18.26
A94047/64	47/64	18.65	0.7344	149.0	248.0	18.65
A94019.0	–	19.00	0.7480	162.0	247.0	19.00
A9403/4	3/4	19.05	0.7500	149.0	248.0	19.05
A94049/64	49/64	19.45	0.7656	152.0	251.0	19.45
A94025/32	25/32	19.84	0.7813	152.0	251.0	19.84
A94020.0	–	20.00	0.7874	166.0	254.0	20.00



A941



Broca PFX HSS-E (5% Cobalto), Serie Larga, con Recubrimiento Alcrona Top

Broca de alto rendimiento, capaz de producir agujeros precisos y de alta calidad a altas velocidades y avances (tolerancia de agujero H10). Punta autocentrante a 130° y diseño especial parabólico de los canales. Apta para la mayoría de materiales. El recubrimiento Alcrona-TOP mejora el rendimiento y prolonga la vida de la herramienta.



PFX

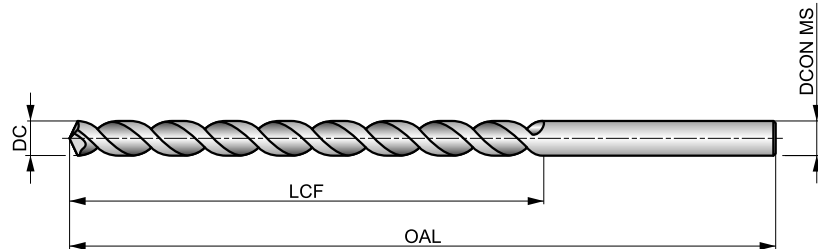

HSS-E	DIN ANSI	10xD
130°	Alcrona Top	
λ > 35°	R	DC h8

Grupo de Material de la pieza adecuado y condiciones de velocidad de corte iniciales (m/min) y código de avance alfabético. Tablas con avance por revolución a partir de la pag.175.

P1.1 ■ 48 G	P1.2 ■ 53 G	P1.3 ■ 55 G	P2.1 ■ 41 G	P2.2 ■ 36 G	P2.3 ■ 32 D	P3.1 ■ 34 G	P3.2 ■ 27 G	P3.3 ■ 23 D	P4.1 ■ 20 G	P4.2 ■ 17 D	P4.3 ■ 14 D	M1.1 ■ 23 C	M1.2 ■ 20 C
M2.1 ■ 21 C	M2.2 ■ 17 C	M3.1 ■ 10 E	M3.2 ■ 9 E	M3.3 ■ 8 E	M4.1 ■ 11 B	K1.1 ■ 36 I	K1.2 ■ 27 I	K1.3 ■ 20 I	K2.1 ■ 37 I	K2.2 ■ 30 I	K2.3 ■ 24 H	K3.1 ■ 33 I	K3.2 ■ 25 I
K3.3 ■ 20 H	K4.1 ■ 30 I	K4.2 ■ 23 I	K4.3 ■ 17 H	K4.4 ■ 14 H	K4.5 ■ 12 H	K5.1 ■ 34 I	K5.2 ■ 26 I	K5.3 ■ 20 H	S1.1 ■ 25 F	S1.2 ■ 18 D	S1.3 ■ 18 D		

DC >= 9.6mm menos de 10xD.

Producto	DC (inch)	DC (mm)	DC (inch)	LCF (mm)	OAL (mm)	DCON MS (mm)
A9411.0	-	1.00	0.0394	33.0	56.0	1.00
A9413/64	3/64	1.19	0.0469	29.0	57.0	1.19
A9411.5	-	1.50	0.0591	45.0	70.0	1.50
A9411/16	1/16	1.59	0.0625	44.0	76.0	1.59
A9415/64	5/64	1.98	0.0781	51.0	95.0	1.98
A9412.0	-	2.00	0.0787	56.0	85.0	2.00
A9413/32	3/32	2.38	0.0938	57.0	108.0	2.38
A9412.5	-	2.50	0.0984	62.0	95.0	2.50
A9417/64	7/64	2.78	0.1094	64.0	117.0	2.78
A9413.0	-	3.00	0.1181	66.0	100.0	3.00
A9413.1	-	3.10	0.1220	69.0	106.0	3.10
A9411/8	1/8	3.18	0.1250	70.0	130.0	3.18
A9413.2	-	3.20	0.1260	69.0	106.0	3.20
A9413.3	-	3.30	0.1299	69.0	106.0	3.30
A9413.4	-	3.40	0.1339	73.0	112.0	3.40
A9413.5	-	3.50	0.1378	73.0	112.0	3.50
A9419/64	9/64	3.57	0.1406	76.0	137.0	3.57
A9413.6	-	3.60	0.1417	73.0	112.0	3.60
A9413.7	-	3.70	0.1457	73.0	112.0	3.70
A9413.8	-	3.80	0.1496	78.0	119.0	3.80
A9413.9	-	3.90	0.1535	78.0	119.0	3.90
A9415/32	5/32	3.97	0.1563	76.0	137.0	3.97
A9414.0	-	4.00	0.1575	78.0	119.0	4.00
A9414.1	-	4.10	0.1614	78.0	119.0	4.10
A9414.2	-	4.20	0.1654	78.0	119.0	4.20
A9414.3	-	4.30	0.1693	82.0	126.0	4.30
A94111/64	11/64	4.37	0.1719	86.0	146.0	4.37

Producto	DC (inch)	DC (mm)	DC (inch)	LCF (mm)	OAL (mm)	DCON MS (mm)
A9414.4	-	4.40	0.1732	82.0	126.0	4.40
A9414.5	-	4.50	0.1772	82.0	126.0	4.50
A9414.6	-	4.60	0.1811	82.0	126.0	4.60
A9414.7	-	4.70	0.1850	82.0	126.0	4.70
A9413/16	3/16	4.76	0.1875	86.0	146.0	4.76
A9414.8	-	4.80	0.1890	87.0	132.0	4.80
A9414.9	-	4.90	0.1929	87.0	132.0	4.90
A9415.0	-	5.00	0.1969	87.0	132.0	5.00
A9415.1	-	5.10	0.2008	87.0	132.0	5.10
A94113/64	13/64	5.16	0.2031	92.0	152.0	5.16
A9415.2	-	5.20	0.2047	87.0	132.0	5.20
A9415.3	-	5.30	0.2087	87.0	132.0	5.30
A9415.4	-	5.40	0.2126	91.0	139.0	5.40
A9415.5	-	5.50	0.2165	91.0	139.0	5.50
A9417/32	7/32	5.56	0.2188	92.0	152.0	5.56
A9415.6	-	5.60	0.2205	91.0	139.0	5.60
A9415.7	-	5.70	0.2244	91.0	139.0	5.70
A9415.8	-	5.80	0.2283	91.0	139.0	5.80
A9415.9	-	5.90	0.2323	91.0	139.0	5.90
A94115/64	15/64	5.95	0.2344	95.0	156.0	5.95
A9416.0	-	6.00	0.2362	91.0	139.0	6.00
A9416.1	-	6.10	0.2402	97.0	148.0	6.10
A9416.2	-	6.20	0.2441	97.0	148.0	6.20
A9416.3	-	6.30	0.2480	97.0	148.0	6.30
A9411/4	1/4	6.35	0.2500	95.0	156.0	6.35
A9416.4	-	6.40	0.2520	97.0	148.0	6.40
A9416.5	-	6.50	0.2559	97.0	148.0	6.50



Producto	DC	DC	DC	LCF	OAL	DCON MS
	(inch)	(mm)	(inch)	(mm)	(mm)	(mm)
A9416.6	–	6.60	0.2598	97.0	148.0	6.60
A9416.7	–	6.70	0.2638	97.0	148.0	6.70
A94117/64	17/64	6.75	0.2656	98.0	159.0	6.75
A9416.8	–	6.80	0.2677	102.0	156.0	6.80
A9416.9	–	6.90	0.2717	102.0	156.0	6.90
A9417.0	–	7.00	0.2756	102.0	156.0	7.00
A9417.1	–	7.10	0.2795	102.0	156.0	7.10
A9419/32	9/32	7.14	0.2813	98.0	159.0	7.14
A9417.2	–	7.20	0.2835	102.0	156.0	7.20
A9417.3	–	7.30	0.2874	102.0	156.0	7.30
A9417.4	–	7.40	0.2913	102.0	156.0	7.40
A9417.5	–	7.50	0.2953	102.0	156.0	7.50
A94119/64	19/64	7.54	0.2969	102.0	162.0	7.54
A9417.6	–	7.60	0.2992	109.0	165.0	7.60
A9417.7	–	7.70	0.3031	109.0	165.0	7.70
A9417.8	–	7.80	0.3071	109.0	165.0	7.80
A9417.9	–	7.90	0.3110	109.0	165.0	7.90
A9415/16	5/16	7.94	0.3125	102.0	162.0	7.94
A9418.0	–	8.00	0.3150	109.0	165.0	8.00
A9418.1	–	8.10	0.3189	109.0	165.0	8.10
A9418.2	–	8.20	0.3228	109.0	165.0	8.20
A9418.3	–	8.30	0.3268	109.0	165.0	8.30
A94121/64	21/64	8.33	0.3281	105.0	165.0	8.33
A9418.4	–	8.40	0.3307	109.0	165.0	8.40
A9418.5	–	8.50	0.3346	109.0	165.0	8.50
A9418.6	–	8.60	0.3386	115.0	175.0	8.60
A9418.7	–	8.70	0.3425	115.0	175.0	8.70
A94111/32	11/32	8.73	0.3438	105.0	165.0	8.73
A9418.8	–	8.80	0.3465	115.0	175.0	8.80
A9418.9	–	8.90	0.3504	115.0	175.0	8.90
A9419.0	–	9.00	0.3543	115.0	175.0	9.00
A9419.1	–	9.10	0.3583	115.0	175.0	9.10
A94123/64	23/64	9.13	0.3594	108.0	171.0	9.13
A9419.2	–	9.20	0.3622	115.0	175.0	9.20
A9419.3	–	9.30	0.3661	115.0	175.0	9.30
A9419.4	–	9.40	0.3701	115.0	175.0	9.40
A9419.5	–	9.50	0.3740	115.0	175.0	9.50
A9413/8	3/8	9.52	0.3750	108.0	171.0	9.52

Producto	DC	DC	DC	LCF	OAL	DCON MS
	(inch)	(mm)	(inch)	(mm)	(mm)	(mm)
A9419.6	–	9.60	0.3780	121.0	184.0	9.60
A9419.7	–	9.70	0.3819	121.0	184.0	9.70
A9419.8	–	9.80	0.3858	121.0	184.0	9.80
A9419.9	–	9.90	0.3898	121.0	184.0	9.90
A94125/64	25/64	9.92	0.3906	111.0	178.0	9.92
A94110.0	–	10.00	0.3937	121.0	184.0	10.00
A94110.2	–	10.20	0.4016	121.0	184.0	10.20
A94110.3	–	10.30	0.4055	121.0	184.0	10.30
A94113/32	13/32	10.32	0.4063	111.0	178.0	10.32
A94110.5	–	10.50	0.4134	121.0	184.0	10.50
A94127/64	27/64	10.72	0.4219	117.0	184.0	10.72
A94111.0	–	11.00	0.4331	128.0	195.0	11.00
A9417/16	7/16	11.11	0.4375	117.0	184.0	11.11
A94111.2	–	11.20	0.4409	128.0	195.0	11.20
A94111.5	–	11.50	0.4528	128.0	195.0	11.50
A94129/64	29/64	11.51	0.4531	121.0	190.0	11.51
A94111.8	–	11.80	0.4646	128.0	195.0	11.80
A94115/32	15/32	11.91	0.4688	121.0	190.0	11.91
A94112.0	–	12.00	0.4724	134.0	205.0	12.00
A94112.2	–	12.20	0.4803	134.0	205.0	12.20
A94131/64	31/64	12.30	0.4844	121.0	197.0	12.30
A94112.5	–	12.50	0.4921	134.0	205.0	12.50
A9411/2	1/2	12.70	0.5000	121.0	197.0	12.70
A94113.0	–	13.00	0.5118	134.0	205.0	13.00
A94133/64	33/64	13.10	0.5156	121.0	203.0	13.10
A94113.5	–	13.50	0.5315	140.0	214.0	13.50
A94135/64	35/64	13.89	0.5469	124.0	210.0	13.89
A94114.0	–	14.00	0.5512	140.0	214.0	14.00
A9419/16	9/16	14.29	0.5625	124.0	210.0	14.29
A94114.5	–	14.50	0.5709	144.0	220.0	14.50
A94137/64	37/64	14.68	0.5781	124.0	222.0	14.68
A94115.0	–	15.00	0.5906	144.0	220.0	15.00
A94119/32	19/32	15.08	0.5938	124.0	222.0	15.08
A94139/64	39/64	15.48	0.6094	124.0	222.0	15.48
A94115.5	–	15.50	0.6102	149.0	227.0	15.50
A9415/8	5/8	15.88	0.6250	124.0	222.0	15.88
A94116.0	–	16.00	0.6299	149.0	227.0	16.00



A125



Broca HSS Serie Extra Larga, Acabado Templado al Vapor

Con acabado templado al vapor y recomendada para agujeros muy profundos o de difícil acceso. Punta convencional a 118°, que proporciona resistencia y ahorra costes en reafilados fáciles. El acabado templado al vapor retiene el fluido de corte y evita la soldadura de la viruta a la herramienta. Menos adecuado para el taladrado manual.

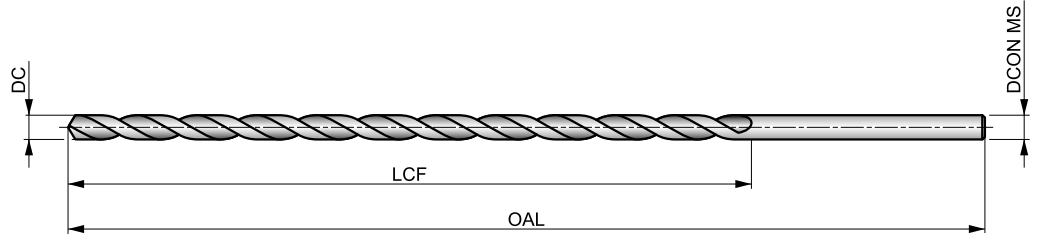

HSS	BS 328	10×D
118°	ST	
λ 20-35°	R	DC h8

Grupo de Material de la pieza adecuado y condiciones de velocidad de corte iniciales (m/min) y código de avance alfabético. Tablas con avance por revolución a partir de la pag.175.

P1.1 ■ 21 E	P1.2 ■ 24 E	P1.3 ■ 25 E	P2.1 ■ 18 E	P2.2 ■ 16 C	P2.3 ■ 14 A	P3.1 ■ 9 C	P3.2 ■ 7 C	P3.3 ■ 6 A	P4.1 ■ 5 C	P4.2 ■ 4 A	P4.3 ■ 4 A	M1.1 ■ 12 C	M1.2 ■ 10 C
M2.1 ■ 11 C	M2.2 ■ 9 C	M3.1 ■ 5 E	M3.2 ■ 4 E	M3.3 ■ 4 E	M4.1 ■ 8 A	K1.1 ■ 22 G	K1.2 ■ 16 D	K1.3 ■ 12 D	K2.1 ■ 16 C	K2.2 ■ 13 C	K2.3 ■ 10 C	K3.1 ■ 14 C	K3.2 ■ 11 C
K3.3 ■ 9 C	K4.1 ■ 13 C	K4.2 ■ 10 C	K4.3 ■ 7 C	K4.4 ■ 6 C	K4.5 ■ 5 C	K5.1 ■ 15 C	K5.2 ■ 11 C	K5.3 ■ 9 C	N1.1 ■ 24 H	N1.2 ■ 18 H	N1.3 ■ 12 G	N2.1 ■ 34 F	N2.2 ■ 30 F
N2.3 ■ 22 F	N3.1 ■ 56 F	N3.2 ■ 33 G	N3.3 ■ 17 D	N4.1 ■ 30 H	N4.2 ■ 26 F	N4.3 ■ 10 D	S1.1 ■ 11 D	S1.2 ■ 9 B	S1.3 ■ 5 A	S2.1 ■ 5 C	S2.2 ■ 4 A	S3.1 ■ 4 C	S3.2 ■ 3 A
S4.1 ■ 3 C	S4.2 ■ 2 A												

DC <= 2.2mm; 5/64" Brillante

Producto	DC (inch)	DC (mm)	DC (inch)	LCF (mm)	OAL (mm)	DCON MS (mm)
A1251.4X160	-	1.40	0.0551	100.0	160.0	1.40
A1251.5X125	-	1.50	0.0591	80.0	125.0	1.50
A1251.5X160	-	1.50	0.0591	100.0	160.0	1.50
A1251/16X125	1/16	1.59	0.0625	80.0	125.0	1.59
A1251/16X160	1/16	1.59	0.0625	100.0	160.0	1.59
A1251.8X160	-	1.80	0.0709	100.0	160.0	1.80
A1255/64X125	5/64	1.98	0.0781	80.0	125.0	1.98
A1255/64X160	5/64	1.98	0.0781	100.0	160.0	1.98
A1252.0X125	-	2.00	0.0787	80.0	125.0	2.00
A1252.0X160	-	2.00	0.0787	100.0	160.0	2.00
A1252.2X160	-	2.20	0.0866	100.0	160.0	2.20
A1253/32X125	3/32	2.38	0.0938	80.0	125.0	2.38
A1253/32X160	3/32	2.38	0.0938	100.0	160.0	2.38
A1252.5X125	-	2.50	0.0984	80.0	125.0	2.50
A1252.5X160	-	2.50	0.0984	100.0	160.0	2.50
A1257/64X125	7/64	2.78	0.1094	80.0	125.0	2.78
A1257/64X160	7/64	2.78	0.1094	100.0	160.0	2.78
A1253.0X160	-	3.00	0.1181	100.0	160.0	3.00
A1253.0X200	-	3.00	0.1181	150.0	200.0	3.00
A1253.0X250	-	3.00	0.1181	200.0	250.0	3.00
A1251/8X160	1/8	3.18	0.1252	100.0	160.0	3.18
A1251/8X200	1/8	3.18	0.1252	150.0	200.0	3.18
A1251/8X250	1/8	3.18	0.1252	200.0	250.0	3.18
A1251/8X315	1/8	3.18	0.1252	250.0	310.0	3.18
A1253.3X160	-	3.30	0.1299	100.0	160.0	3.30
A1253.5X160	-	3.50	0.1378	100.0	160.0	3.50

Producto	DC (inch)	DC (mm)	DC (inch)	LCF (mm)	OAL (mm)	DCON MS (mm)
A1253.5X200	-	3.50	0.1378	150.0	200.0	3.50
A1253.5X250	-	3.50	0.1378	200.0	250.0	3.50
A1259/64X160	9/64	3.57	0.1406	100.0	160.0	3.57
A1259/64X200	9/64	3.57	0.1406	150.0	200.0	3.57
A1259/64X315	9/64	3.57	0.1406	250.0	310.0	3.57
A1255/32X160	5/32	3.97	0.1563	100.0	160.0	3.97
A1255/32X200	5/32	3.97	0.1563	150.0	200.0	3.97
A1255/32X250	5/32	3.97	0.1563	200.0	250.0	3.97
A1255/32X315	5/32	3.97	0.1563	250.0	310.0	3.97
A1254.0X160	-	4.00	0.1575	100.0	160.0	4.00
A1254.0X200	-	4.00	0.1575	150.0	200.0	4.00
A1254.0X250	-	4.00	0.1575	200.0	250.0	4.00
A1254.0X315	-	4.00	0.1575	250.0	310.0	4.00
A12511/64X160	11/64	4.37	0.1719	100.0	160.0	4.37
A12511/64X200	11/64	4.37	0.1719	150.0	200.0	4.37
A12511/64X315	11/64	4.37	0.1719	250.0	310.0	4.37
A1254.5X160	-	4.50	0.1772	100.0	160.0	4.50
A1254.5X200	-	4.50	0.1772	150.0	200.0	4.50
A1254.5X250	-	4.50	0.1772	200.0	250.0	4.50
A1254.5X315	-	4.50	0.1772	250.0	310.0	4.50
A1253/16X160	3/16	4.76	0.1875	100.0	160.0	4.76
A1253/16X200	3/16	4.76	0.1875	150.0	200.0	4.76
A1253/16X250	3/16	4.76	0.1875	200.0	250.0	4.76
A1253/16X315	3/16	4.76	0.1875	250.0	310.0	4.76
A1253/16X400	3/16	4.76	0.1875	300.0	400.0	4.76
A1255.0X160	-	5.00	0.1969	100.0	160.0	5.00



Producto	DC	DC	DC	LCF	OAL	DCON MS
	(inch)	(mm)	(inch)	(mm)	(mm)	(mm)
A1255.0X200	–	5.00	0.1969	150.0	200.0	5.00
A1255.0X250	–	5.00	0.1969	200.0	250.0	5.00
A1255.0X315	–	5.00	0.1969	250.0	310.0	5.00
A1255.0X400	–	5.00	0.1969	300.0	400.0	5.00
A12513/64X200	13/64	5.16	0.2031	150.0	200.0	5.16
A12513/64X250	13/64	5.16	0.2031	200.0	250.0	5.16
A12513/64X315	13/64	5.16	0.2031	250.0	310.0	5.16
A1255.5X200	–	5.50	0.2165	150.0	200.0	5.50
A1255.5X250	–	5.50	0.2165	200.0	250.0	5.50
A1255.5X315	–	5.50	0.2165	250.0	310.0	5.50
A1257/32X200	7/32	5.56	0.2188	150.0	200.0	5.56
A1257/32X250	7/32	5.56	0.2188	200.0	250.0	5.56
A1257/32X315	7/32	5.56	0.2188	250.0	310.0	5.56
A12515/64X200	15/64	5.95	0.2344	150.0	200.0	5.95
A12515/64X250	15/64	5.95	0.2344	200.0	250.0	5.95
A12515/64X315	15/64	5.95	0.2344	250.0	310.0	5.95
A1256.0X200	–	6.00	0.2362	150.0	200.0	6.00
A1256.0X250	–	6.00	0.2362	200.0	250.0	6.00
A1256.0X315	–	6.00	0.2362	250.0	310.0	6.00
A1256.0X400	–	6.00	0.2362	300.0	400.0	6.00
A1251/4X200	1/4	6.35	0.2500	150.0	200.0	6.35
A1251/4X250	1/4	6.35	0.2500	200.0	250.0	6.35
A1251/4X315	1/4	6.35	0.2500	250.0	310.0	6.35
A1251/4X400	1/4	6.35	0.2500	300.0	400.0	6.35
A1251/4X500	1/4	6.35	0.2500	400.0	460.0	6.35
A1256.5X200	–	6.50	0.2559	150.0	200.0	6.50
A1256.5X250	–	6.50	0.2559	200.0	250.0	6.50
A1256.5X315	–	6.50	0.2559	250.0	310.0	6.50
A12517/64X200	17/64	6.75	0.2656	150.0	200.0	6.75
A12517/64X250	17/64	6.75	0.2656	200.0	250.0	6.75
A12517/64X500	17/64	6.75	0.2656	400.0	460.0	6.75
A1257.0X200	–	7.00	0.2756	150.0	200.0	7.00
A1257.0X250	–	7.00	0.2756	200.0	250.0	7.00
A1257.0X315	–	7.00	0.2756	250.0	310.0	7.00
A1259/32X200	9/32	7.14	0.2813	150.0	200.0	7.14
A1259/32X250	9/32	7.14	0.2813	200.0	250.0	7.14
A1259/32X315	9/32	7.14	0.2813	250.0	310.0	7.14
A1259/32X500	9/32	7.14	0.2813	400.0	460.0	7.14
A1257.5X200	–	7.50	0.2953	150.0	200.0	7.50
A1257.5X250	–	7.50	0.2953	200.0	250.0	7.50
A1257.5X315	–	7.50	0.2953	250.0	310.0	7.50
A12519/64X315	19/64	7.54	0.2969	250.0	310.0	7.54
A12519/64X500	19/64	7.54	0.2969	400.0	460.0	7.54
A1255/16X200	5/16	7.94	0.3125	150.0	200.0	7.94
A1255/16X250	5/16	7.94	0.3125	200.0	250.0	7.94
A1255/16X315	5/16	7.94	0.3125	250.0	310.0	7.94
A1255/16X400	5/16	7.94	0.3125	300.0	400.0	7.94
A1255/16X500	5/16	7.94	0.3125	400.0	460.0	7.94
A1258.0X250	–	8.00	0.3150	200.0	250.0	8.00
A1258.0X315	–	8.00	0.3150	250.0	310.0	8.00
A1258.0X400	–	8.00	0.3150	300.0	400.0	8.00
A12521/64X315	21/64	8.33	0.3281	250.0	310.0	8.33
A12521/64X500	21/64	8.33	0.3281	400.0	460.0	8.33
A1258.5X250	–	8.50	0.3346	200.0	250.0	8.50
A1258.5X315	–	8.50	0.3346	250.0	310.0	8.50
A12511/32X250	11/32	8.73	0.3438	200.0	250.0	8.73
A12511/32X315	11/32	8.73	0.3438	250.0	310.0	8.73
A12511/32X400	11/32	8.73	0.3438	300.0	400.0	8.73
A12511/32X500	11/32	8.73	0.3438	400.0	460.0	8.73
A1259.0X250	–	9.00	0.3543	200.0	250.0	9.00
A1259.0X315	–	9.00	0.3543	250.0	310.0	9.00
A1259.0X400	–	9.00	0.3543	300.0	400.0	9.00
A12523/64X315	23/64	9.13	0.3594	250.0	310.0	9.13
A12523/64X500	23/64	9.13	0.3594	400.0	460.0	9.13
A1259.5X250	–	9.50	0.3740	200.0	250.0	9.50
A1259.5X315	–	9.50	0.3740	250.0	310.0	9.50
A1253/8X250	3/8	9.52	0.3750	200.0	250.0	9.52
A1253/8X315	3/8	9.52	0.3750	250.0	310.0	9.52
A1253/8X400	3/8	9.52	0.3750	300.0	400.0	9.52

Producto	DC	DC	DC	LCF	OAL	DCON MS
	(inch)	(mm)	(inch)	(mm)	(mm)	(mm)
A1253/8X500	3/8	9.52	0.3750	400.0	460.0	9.52
A12525/64X315	25/64	9.92	0.3906	250.0	310.0	9.92
A12525/64X500	25/64	9.92	0.3906	400.0	460.0	9.92
A12510.0X250	–	10.00	0.3937	200.0	250.0	10.00
A12510.0X315	–	10.00	0.3937	250.0	310.0	10.00
A12510.0X400	–	10.00	0.3937	300.0	400.0	10.00
A12513/32X250	13/32	10.32	0.4063	200.0	250.0	10.32
A12513/32X315	13/32	10.32	0.4063	250.0	310.0	10.32
A12513/32X500	13/32	10.32	0.4063	400.0	460.0	10.32
A12510.5X250	–	10.50	0.4134	200.0	250.0	10.50
A12510.5X315	–	10.50	0.4134	250.0	310.0	10.50
A12510.5X400	–	10.50	0.4134	300.0	400.0	10.50
A12527/64X315	27/64	10.72	0.4219	250.0	310.0	10.72
A12511.0X250	–	11.00	0.4331	200.0	250.0	11.00
A12511.0X315	–	11.00	0.4331	250.0	310.0	11.00
A12511.0X400	–	11.00	0.4331	300.0	400.0	11.00
A1257/16X250	7/16	11.11	0.4375	200.0	250.0	11.11
A1257/16X315	7/16	11.11	0.4375	250.0	310.0	11.11
A1257/16X400	7/16	11.11	0.4375	300.0	400.0	11.11
A1257/16X500	7/16	11.11	0.4375	400.0	460.0	11.11
A12529/64X315	29/64	11.51	0.4531	250.0	310.0	11.51
A12529/64X500	29/64	11.51	0.4531	400.0	460.0	11.51
A12515/32X250	15/32	11.91	0.4688	200.0	250.0	11.91
A12515/32X315	15/32	11.91	0.4688	250.0	310.0	11.91
A12515/32X500	15/32	11.91	0.4688	400.0	460.0	11.91
A12512.0X250	–	12.00	0.4724	200.0	250.0	12.00
A12512.0X315	–	12.00	0.4724	250.0	310.0	12.00
A12512.0X400	–	12.00	0.4724	300.0	400.0	12.00
A12531/64X315	31/64	12.30	0.4844	250.0	310.0	12.30
A12531/64X500	31/64	12.30	0.4844	400.0	460.0	12.30
A1251/2X250	1/2	12.70	0.5000	200.0	250.0	12.70
A1251/2X315	1/2	12.70	0.5000	250.0	310.0	12.70
A1251/2X400	1/2	12.70	0.5000	300.0	400.0	12.70
A1251/2X500	1/2	12.70	0.5000	400.0	460.0	12.70
A12513.0X315	–	13.00	0.5118	250.0	310.0	13.00
A12513.0X400	–	13.00	0.5118	300.0	400.0	13.00
A12533/64X315	33/64	13.10	0.5156	250.0	310.0	13.10
A12533/64X500	33/64	13.10	0.5156	400.0	460.0	13.10
A12517/32X315	17/32	13.49	0.5313	250.0	310.0	13.49
A12517/32X500	17/32	13.49	0.5313	400.0	460.0	13.49
A12535/64X315	35/64	13.89	0.5469	250.0	310.0	13.89
A12535/64X500	35/64	13.89	0.5469	400.0	460.0	13.89
A12514.0X315	–	14.00	0.5512	250.0	310.0	14.00
A12514.0X400	–	14.00	0.5512	300.0	400.0	14.00
A1259/16X315	9/16	14.29	0.5625	250.0	310.0	14.29
A1259/16X500	9/16	14.29	0.5625	400.0	460.0	14.29
A12537/64X315	37/64	14.68	0.5781	250.0	310.0	14.68
A12519/32X315	19/32	15.08	0.5938	250.0	310.0	15.08
A12519/32X500	19/32	15.08	0.5938	400.0	460.0	15.08
A12539/64X315	39/64	15.48	0.6094	250.0	310.0	15.48
A12539/64X500	39/64	15.48	0.6094	400.0	460.0	15.48
A1255/8X315	5/8	15.88	0.6250	250.0	310.0	15.88
A1255/8X500	5/8	15.88	0.6250	400.0	460.0	15.88
A12521/32X315	21/32	16.67	0.6563	250.0	310.0	16.67
A12521/32X500	21/32	16.67	0.6563	400.0	460.0	16.67
A12511/16X315	11/16	17.46	0.6875	250.0	310.0	17.46
A12511/16X500	11/16	17.46	0.6875	400.0	460.0	17.46
A12523/32X315	23/32	18.26	0.7188	250.0	310.0	18.26
A12523/32X500	23/32	18.26	0.7188	400.0	460.0	18.26
A1253/4X315	3/4	19.05	0.7500	250.0	310.0	19.05
A1253/4X500	3/4	19.05	0.7500	400.0	460.0	19.05
A12525/32X500	25/32	19.84	0.7813	400.0	460.0	19.84
A12513/16X500	13/16	20.64	0.8125	400.0	460.0	20.64
A1257/8X500	7/8	22.22	0.8750	400.0	460.0	22.22
A12515/16X500	15/16	23.81	0.9375	400.0	460.0	23.81
A1251X500	1"	25.40	1.0000	400.0	460.0	25.40



A976



Broca PFX HSS-E (5% Cobalto), Serie Extra Larga DIN 1869-1, Acabado Brillante

Recomendada para taladrar agujeros muy profundos o para aplicaciones donde se necesita un alcance adicional. Los canales parabólicos están especialmente diseñados para eliminar la necesidad de taladrar agujeros profundos en pasos cortos (picoteo). Se recomienda un punteado de centro a 130° con una broca corta PFX 3xD (para mantener la misma tolerancia del DC). Adecuada para taladrar muchos materiales.

PFX

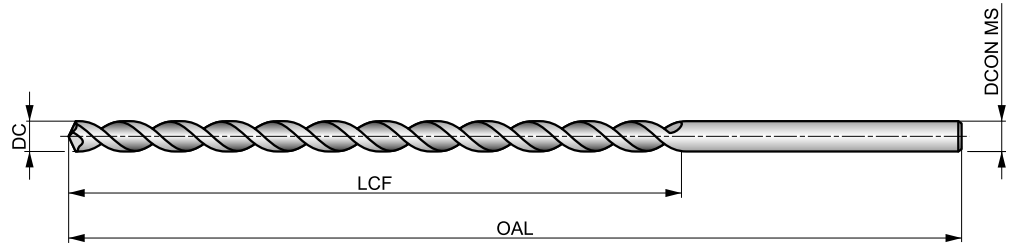

HSS-E	DIN 1869-1	15×D
130°	Bright	
λ>35°	R	DC h8

Grupo de Material de la pieza adecuado y condiciones de velocidad de corte iniciales (m/min) y código de avance alfabético. Tablas con avance por revolución a partir de la pag.175.

P1.1 ■29 C	P1.2 ■33 C	P1.3 ■34 C	P2.1 ■25 C	P2.2 ■22 C	P2.3 ■19 A	P3.1 ■18 C	P3.2 ■14 C	P3.3 ■12 A	P4.1 ■11 C	P4.2 ■9 A	P4.3 ■7 A	M1.1 ■16 B	M1.2 ■14 B
M2.1 ■15 B	M2.2 ■12 B	M3.1 ■8 C	M3.2 ■7 C	M3.3 ■6 C	M4.1 ■8 A	K2.1 ■20 C	K2.2 ■16 C	K2.3 ■13 A	K3.1 ■17 C	K3.2 ■13 C	K3.3 ■11 A	K4.1 ■16 C	K4.2 ■12 C
K4.3 ■9 A	K4.4 ■8 A	K4.5 ■6 A	K5.1 ■18 C	K5.2 ■14 C	K5.3 ■11 A	N3.1 ■30 D	S1.1 ■15 C	S1.2 ■11 A	S1.3 ■5 A				

Producto	DC (inch)	DC (mm)	DC (inch)	LCF (mm)	OAL (mm)	DCON MS (mm)
A9761.5	—	1.50	0.0591	75.0	115.0	1.50
A9762.0X125	—	2.00	0.0787	85.0	125.0	2.00
A9762.1X125	—	2.10	0.0827	85.0	125.0	2.10
A9762.2X135	—	2.20	0.0866	90.0	135.0	2.20
A9762.3X135	—	2.30	0.0906	90.0	135.0	2.30
A9762.4X140	—	2.40	0.0945	95.0	140.0	2.40
A9762.5X140	—	2.50	0.0984	95.0	140.0	2.50
A9762.6X140	—	2.60	0.1024	95.0	140.0	2.60
A9762.7X150	—	2.70	0.1063	100.0	150.0	2.70
A9762.8X150	—	2.80	0.1102	100.0	150.0	2.80
A9762.9X150	—	2.90	0.1142	100.0	150.0	2.90
A9763.0X150	—	3.00	0.1181	100.0	150.0	3.00
A9763.1X155	—	3.10	0.1220	105.0	155.0	3.10
A9761/8	1/8	3.18	0.1252	105.0	155.0	3.18
A9763.2X155	—	3.20	0.1260	105.0	155.0	3.20
A9763.3X155	—	3.30	0.1299	105.0	155.0	3.30
A9763.4X165	—	3.40	0.1339	115.0	165.0	3.40
A9763.5X165	—	3.50	0.1378	115.0	165.0	3.50
A9763.6X165	—	3.60	0.1417	115.0	165.0	3.60
A9763.7X165	—	3.70	0.1457	115.0	165.0	3.70
A9763.8X175	—	3.80	0.1496	120.0	175.0	3.80
A9763.9X175	—	3.90	0.1535	120.0	175.0	3.90
A9765/32	5/32	3.97	0.1563	120.0	175.0	3.97
A9764.0X175	—	4.00	0.1575	120.0	175.0	4.00
A9764.1X175	—	4.10	0.1614	120.0	175.0	4.10
A9764.2X175	—	4.20	0.1654	120.0	175.0	4.20
A9764.3X185	—	4.30	0.1693	125.0	185.0	4.30
A9764.4X185	—	4.40	0.1732	125.0	185.0	4.40

Producto	DC (inch)	DC (mm)	DC (inch)	LCF (mm)	OAL (mm)	DCON MS (mm)
A9764.5X185	—	4.50	0.1772	125.0	185.0	4.50
A9764.6X185	—	4.60	0.1811	125.0	185.0	4.60
A9764.7X185	—	4.70	0.1850	125.0	185.0	4.70
A9763/16	3/16	4.76	0.1875	135.0	195.0	4.76
A9764.8X195	—	4.80	0.1890	135.0	195.0	4.80
A9764.9X195	—	4.90	0.1929	135.0	195.0	4.90
A9765.0X195	—	5.00	0.1969	135.0	195.0	5.00
A9765.1X195	—	5.10	0.2008	135.0	195.0	5.10
A9765.2X195	—	5.20	0.2047	135.0	195.0	5.20
A9765.3X195	—	5.30	0.2087	135.0	195.0	5.30
A9765.4X205	—	5.40	0.2126	140.0	205.0	5.40
A9765.5X205	—	5.50	0.2165	140.0	205.0	5.50
A9765.6X205	—	5.60	0.2205	140.0	205.0	5.60
A9765.7X205	—	5.70	0.2244	140.0	205.0	5.70
A9765.8X205	—	5.80	0.2283	140.0	205.0	5.80
A9765.9X205	—	5.90	0.2323	140.0	205.0	5.90
A9766.0X205	—	6.00	0.2362	140.0	205.0	6.00
A9766.1X215	—	6.10	0.2402	150.0	215.0	6.10
A9766.2X215	—	6.20	0.2441	150.0	215.0	6.20
A9766.3X215	—	6.30	0.2480	150.0	215.0	6.30
A9761/4	1/4	6.35	0.2500	150.0	215.0	6.35
A9766.4X215	—	6.40	0.2520	150.0	215.0	6.40
A9766.5X215	—	6.50	0.2559	150.0	215.0	6.50
A9766.6X215	—	6.60	0.2598	150.0	215.0	6.60
A9766.7X215	—	6.70	0.2638	150.0	215.0	6.70
A9766.8X225	—	6.80	0.2677	155.0	225.0	6.80
A9766.9X225	—	6.90	0.2717	155.0	225.0	6.90
A9767.0X225	—	7.00	0.2756	155.0	225.0	7.00



Producto	DC	DC	DC	LCF	OAL	DCON MS
	(inch)	(mm)	(inch)	(mm)	(mm)	(mm)
A9767.5X225	–	7.50	0.2953	155.0	225.0	7.50
A9765/16	5/16	7.94	0.3125	165.0	240.0	7.94
A9768.0X240	–	8.00	0.3150	165.0	240.0	8.00
A9768.5X240	–	8.50	0.3346	165.0	240.0	8.50
A97611/32	11/32	8.73	0.3438	175.0	250.0	8.73
A9769.0X250	–	9.00	0.3543	175.0	250.0	9.00
A9769.5X250	–	9.50	0.3740	175.0	250.0	9.50
A9763/8	3/8	9.52	0.3750	185.0	265.0	9.52
A97610.0X265	–	10.00	0.3937	185.0	265.0	10.00

¹⁾ Norma Dormer

Producto	DC	DC	DC	LCF	OAL	DCON MS
	(inch)	(mm)	(inch)	(mm)	(mm)	(mm)
A97610.5	–	10.50	0.4134	185.0	265.0	10.50
A97611.0	–	11.00	0.4331	195.0	280.0	11.00
A9767/16	7/16	11.11	0.4375	195.0	280.0	11.11
A97611.5	–	11.50	0.4528	195.0	280.0	11.50
A97612.0	–	12.00	0.4724	205.0	295.0	12.00
A97612.5	–	12.50	0.4921	205.0	295.0	12.50
A9761/2	1/2	12.70	0.5000	205.0	295.0	12.70
A97613.0	–	13.00	0.5118	205.0	295.0	13.00
A97614.0 ¹⁾	–	14.00	0.5512	215.0	310.0	14.00



A977



Broca PFX HSS-E (5% Cobalto), Serie Extra Larga DIN 1869-2, Acabado Brillante

Recomendada para taladrar agujeros muy profundos y para aplicaciones donde se necesita un alcance adicional. Los canales parabólicos están especialmente diseñados para eliminar la necesidad de taladrar agujeros profundos en pasos cortos (picoteo). Se recomienda un punteado de centro a 130° con una broca corta PFX 3xD (para mantener la misma tolerancia del DC). Adecuada para taladrar muchos materiales.

PFX

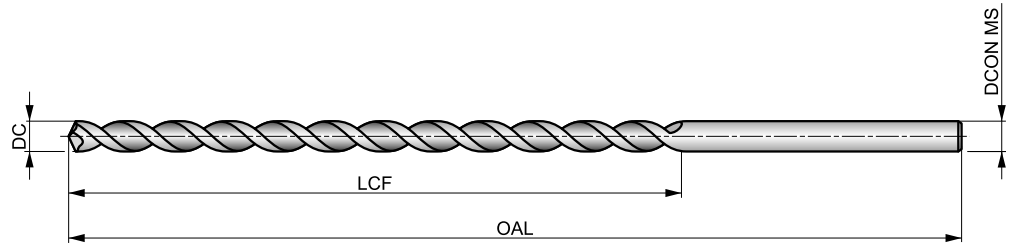

HSS-E	DIN 1869-2	20xD
130°	Bright	
λ > 35°	R	DC h8

Grupo de Material de la pieza adecuado y condiciones de velocidad de corte iniciales (m/min) y código de avance alfabético. Tablas con avance por revolución a partir de la pag.175.

P1.1 ▣29 B	P1.2 ▣33 B	P1.3 ▣34 B	P2.1 ▣25 B	P2.2 ▣22 B	P2.3 ▣19 A	P3.1 ▣18 B	P3.2 ▣14 B	P3.3 ▣12 A	P4.1 ▣11 B	P4.2 ▣9 A	P4.3 ▣7 A	M1.1 ▣16 B	M1.2 ▣14 B
M2.1 ▣15 B	M2.2 ▣12 B	M3.1 ▣8 B	M3.2 ▣7 B	M3.3 ▣6 B	M4.1 ▣8 A	K2.1 ▣20 B	K2.2 ▣16 B	K2.3 ▣13 A	K3.1 ▣17 B	K3.2 ▣13 B	K3.3 ▣11 A	K4.1 ▣16 B	K4.2 ▣12 B
K4.3 ▣9 A	K4.4 ▣8 A	K4.5 ▣6 A	K5.1 ▣18 B	K5.2 ▣14 B	K5.3 ▣11 A	N3.1 ▣30 C	S1.1 ▣15 B	S1.2 ▣11 A	S1.3 ▣5 A				

Producto	DC (inch)	DC (mm)	DC (inch)	LCF (mm)	OAL (mm)	DCON MS (mm)
A9771.5 ¹⁾	—	1.50	0.0591	100.0	150.0	1.50
A9771/16 ¹⁾	1/16	1.59	0.0625	100.0	150.0	1.59
A9772.0 ¹⁾	—	2.00	0.0787	110.0	160.0	2.00
A9773/32 ¹⁾	3/32	2.38	0.0938	115.0	170.0	2.38
A9773.0X190	—	3.00	0.1181	130.0	190.0	3.00
A9771/8	1/8	3.18	0.1250	135.0	200.0	3.18
A9773.5X210	—	3.50	0.1378	145.0	210.0	3.50
A9774.0X220	—	4.00	0.1575	150.0	220.0	4.00
A9774.5X235	—	4.50	0.1772	160.0	235.0	4.50
A9773/16	3/16	4.76	0.1875	170.0	245.0	4.76
A9775.0X245	—	5.00	0.1969	170.0	245.0	5.00
A9775.5X260	—	5.50	0.2165	180.0	260.0	5.50
A9776.0X260	—	6.00	0.2362	180.0	260.0	6.00
A9771/4	1/4	6.35	0.2500	190.0	275.0	6.35
A9776.5X275	—	6.50	0.2559	190.0	275.0	6.50

Producto	DC (inch)	DC (mm)	DC (inch)	LCF (mm)	OAL (mm)	DCON MS (mm)
A9777.0X290	—	7.00	0.2756	200.0	290.0	7.00
A9777.5X290	—	7.50	0.2953	200.0	290.0	7.50
A9778.0X305	—	8.00	0.3150	210.0	305.0	8.00
A9778.5X305	—	8.50	0.3346	210.0	305.0	8.50
A97711/32	11/32	8.73	0.3438	220.0	320.0	8.73
A9779.0X320	—	9.00	0.3543	220.0	320.0	9.00
A9779.5X320	—	9.50	0.3740	220.0	320.0	9.50
A97710.0X340	—	10.00	0.3937	235.0	340.0	10.00
A97710.5	—	10.50	0.4134	235.0	340.0	10.50
A97711.0	—	11.00	0.4331	250.0	365.0	11.00
A97711.5	—	11.50	0.4528	250.0	365.0	11.50
A97712.0	—	12.00	0.4724	260.0	375.0	12.00
A97712.5	—	12.50	0.4921	260.0	375.0	12.50
A97713.0	—	13.00	0.5118	260.0	375.0	13.00
A97714.0 ¹⁾	—	14.00	0.5512	270.0	390.0	14.00

¹⁾ Norma Dormer



A978



Broca PFX HSS-E (5% Cobalto), Serie Extra Larga DIN 1869-3, Acabado Brillante

Recomendada para taladrar agujeros muy profundos y para aplicaciones donde se necesita un alcance adicional. Los canales parabólicos están especialmente diseñados para eliminar la necesidad de taladrar agujeros profundos en pasos cortos (picoteo). Se recomienda un punteado de centro a 130° con una broca corta PFX 3xD (para mantener la misma tolerancia del DC). Adecuada para taladrar muchos materiales.

PFX

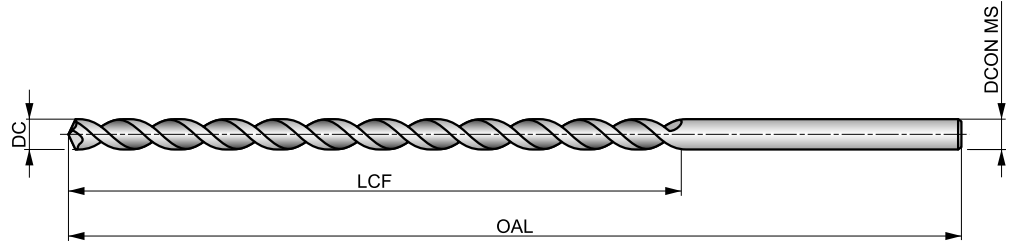

HSS-E	DIN 1869-3	25xD
130°	Bright	
$\lambda > 35^\circ$	R	DC h8

Grupo de Material de la pieza adecuado y condiciones de velocidad de corte iniciales (m/min) y código de avance alfabético. Tablas con avance por revolución a partir de la pag.175.

P1.1 ▣29 A	P1.2 ▣33 A	P1.3 ▣34 A	P2.1 ▣25 A	P2.2 ▣22 A	P2.3 ▣19 A	P3.1 ▣18 A	P3.2 ▣14 A	P3.3 ▣12 A	P4.1 ▣11 A	P4.2 ▣9 A	P4.3 ▣7 A	M1.1 ▣16 A	M1.2 ▣14 A
M2.1 ▣15 A	M2.2 ▣12 A	M3.1 ▣8 A	M3.2 ▣17 A	M3.3 ▣6 A	M4.1 ▣8 A	K2.1 ▣20 A	K2.2 ▣16 A	K2.3 ▣13 A	K3.1 ▣17 A	K3.2 ▣13 A	K3.3 ▣11 A	K4.1 ▣16 A	K4.2 ▣12 A
K4.3 ▣9 A	K4.4 ▣8 A	K4.5 ▣6 A	K5.1 ▣18 A	K5.2 ▣14 A	K5.3 ▣11 A	N3.1 ▣30 B	S1.1 ▣15 A	S1.2 ▣11 A	S1.3 ▣5 A				

Producto	DC	DC	DC	LCF	OAL	DCON MS
	(inch)	(mm)	(inch)			
A9783.0 ¹⁾	—	3.00	0.1181	160.0	240.0	3.00
A9783.5X265	—	3.50	0.1378	180.0	265.0	3.50
A9784.0X280	—	4.00	0.1575	190.0	280.0	4.00
A9784.5X295	—	4.50	0.1772	200.0	295.0	4.50
A9785.0X315	—	5.00	0.1969	210.0	315.0	5.00
A9785.5X330	—	5.50	0.2165	225.0	330.0	5.50
A9786.0X330	—	6.00	0.2362	225.0	330.0	6.00
A9781/4	1/4	6.35	0.2500	235.0	350.0	6.35
A9786.5X350	—	6.50	0.2559	235.0	350.0	6.50
A9787.0X370	—	7.00	0.2756	250.0	370.0	7.00
A9787.5X370	—	7.50	0.2953	250.0	370.0	7.50
A9788.0X390	—	8.00	0.3150	265.0	390.0	8.00
A9788.5X390	—	8.50	0.3346	265.0	390.0	8.50
A9789.0X410	—	9.00	0.3543	280.0	410.0	9.00
A9789.5X410	—	9.50	0.3740	280.0	410.0	9.50
A97810.0X430	—	10.00	0.3937	295.0	430.0	10.00

¹⁾ Norma Dormer



A130



Broca HSS, Mango Cónico, Acabado Templado al Vapor

Broca versátil con diámetros más grandes: hasta 50,80 mm (2 pulgadas). El mango cónico proporciona un mejor agarre al sujetarlo en la máquina. La punta convencional a 118° proporciona resistencia y facilita el reafilado. El acabado templado al vapor retiene el fluido de corte y evita la soldadura de la viruta a la herramienta. Apta para taladrar muchos materiales.

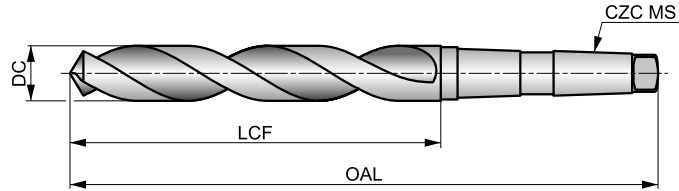

HSS	DIN 345	4xD
118°	ST	
λ 20-35°	R	DC h8

Grupo de Material de la pieza adecuado y condiciones de velocidad de corte iniciales (m/min) y código de avance alfabético. Tablas con avance por revolución a partir de la pag.175.

P1.1 ■ 33 I	P1.2 ■ 37 I	P1.3 ■ 38 I	P2.1 ■ 28 I	P2.2 ■ 25 F	P2.3 ■ 22 E	P3.1 ■ 18 F	P3.2 ■ 14 F	P3.3 ■ 12 E	P4.1 ■ 11 F	P4.2 ■ 9 E	P4.3 ■ 7 D	M1.1 ■ 21 E	M1.2 ■ 17 E
M2.1 ■ 18 E	M2.2 ■ 15 E	M3.1 ■ 10 G	M3.2 ■ 9 G	M3.3 ■ 8 G	M4.1 ■ 10 C	K1.1 ■ 30 I	K1.2 ■ 22 E	K1.3 ■ 17 E	K2.1 ■ 25 E	K2.2 ■ 20 E	K2.3 ■ 16 E	K3.1 ■ 22 E	K3.2 ■ 17 E
K3.3 ■ 13 E	K4.1 ■ 20 E	K4.2 ■ 15 E	K4.3 ■ 11 E	K4.4 ■ 10 E	K4.5 ■ 8 E	K5.1 ■ 23 E	K5.2 ■ 17 E	K5.3 ■ 13 E	N1.1 ■ 26 J	N1.2 ■ 20 J	N1.3 ■ 13 I	N2.1 ■ 43 H	N2.2 ■ 39 H
N2.3 ■ 28 H	N3.1 ■ 59 H	N3.2 ■ 35 I	N3.3 ■ 18 F	N4.1 ■ 30 K	N4.2 ■ 28 J	N4.3 ■ 14 H	S1.1 ■ 23 F	S1.2 ■ 13 D	S1.3 ■ 7 B	S2.1 ■ 9 E	S2.2 ■ 6 A	S3.1 ■ 7 E	S3.2 ■ 4 A
S4.1 ■ 5 E	S4.2 ■ 3 A												

DC > 14mm Punta Adelgazada

Producto	DC	DC	DC	LCF	OAL	CZC MS
	(inch)	(mm)	(inch)	(mm)	(mm)	
A1303.0	—	3.00	0.1181	33.0	114.0	MK 1
A1301/8	1/8	3.18	0.1252	36.0	117.0	MK 1
A1303.2	—	3.20	0.1260	36.0	117.0	MK 1
A1303.25	—	3.25	0.1280	36.0	117.0	MK 1
A1303.3	—	3.30	0.1299	36.0	117.0	MK 1
A1303.5	—	3.50	0.1378	39.0	120.0	MK 1
A1309/64	9/64	3.57	0.1406	39.0	120.0	MK 1
A1303.75	—	3.75	0.1476	39.0	120.0	MK 1
A1305/32	5/32	3.97	0.1563	43.0	124.0	MK 1
A1304.0	—	4.00	0.1575	43.0	124.0	MK 1
A1304.1	—	4.10	0.1614	43.0	124.0	MK 1
A1304.2	—	4.20	0.1654	43.0	124.0	MK 1
A1304.25	—	4.25	0.1673	43.0	124.0	MK 1
A13011/64	11/64	4.37	0.1719	47.0	128.0	MK 1
A1304.5	—	4.50	0.1772	47.0	128.0	MK 1
A1304.75	—	4.75	0.1870	52.0	128.0	MK 1
A1303/16	3/16	4.76	0.1875	52.0	133.0	MK 1
A1304.8	—	4.80	0.1890	52.0	133.0	MK 1
A1304.9	—	4.90	0.1929	52.0	133.0	MK 1
A1305.0	—	5.00	0.1969	52.0	133.0	MK 1
A1305.1	—	5.10	0.2008	52.0	133.0	MK 1
A13013/64	13/64	5.16	0.2031	52.0	133.0	MK 1
A1305.2	—	5.20	0.2047	52.0	133.0	MK 1



Producto	DC	DC	DC	LCF	OAL	CZC MS
	(inch)	(mm)	(inch)	(mm)	(mm)	
A1305.25	–	5.25	0.2067	52.0	133.0	MK 1
A1305.4	–	5.40	0.2126	57.0	138.0	MK 1
A1305.5	–	5.50	0.2165	57.0	138.0	MK 1
A1307/32	7/32	5.56	0.2188	57.0	138.0	MK 1
A1305.7	–	5.70	0.2244	57.0	138.0	MK 1
A1305.75	–	5.75	0.2264	57.0	138.0	MK 1
A1305.8	–	5.80	0.2283	57.0	138.0	MK 1
A1305.9	–	5.90	0.2323	57.0	138.0	MK 1
A13015/64	15/64	5.95	0.2344	57.0	138.0	MK 1
A1306.0	–	6.00	0.2362	57.0	138.0	MK 1
A1306.1	–	6.10	0.2402	63.0	144.0	MK 1
A1306.2	–	6.20	0.2441	63.0	144.0	MK 1
A1306.25	–	6.25	0.2461	63.0	144.0	MK 1
A1306.3	–	6.30	0.2480	63.0	144.0	MK 1
A1301/4	1/4	6.35	0.2500	63.0	144.0	MK 1
A1306.4	–	6.40	0.2520	63.0	144.0	MK 1
A1306.5	–	6.50	0.2559	63.0	144.0	MK 1
A1306.6	–	6.60	0.2598	63.0	144.0	MK 1
A1306.7	–	6.70	0.2638	63.0	144.0	MK 1
A13017/64	17/64	6.75	0.2656	69.0	150.0	MK 1
A1306.75	–	6.75	0.2657	69.0	150.0	MK 1
A1306.8	–	6.80	0.2677	69.0	150.0	MK 1
A1306.9	–	6.90	0.2717	69.0	150.0	MK 1
A1307.0	–	7.00	0.2756	69.0	150.0	MK 1
A1309/32	9/32	7.14	0.2813	69.0	150.0	MK 1
A1307.2	–	7.20	0.2835	69.0	150.0	MK 1
A1307.25	–	7.25	0.2854	69.0	150.0	MK 1
A1307.3	–	7.30	0.2874	69.0	150.0	MK 1
A1307.4	–	7.40	0.2913	69.0	150.0	MK 1
A1307.5	–	7.50	0.2953	69.0	150.0	MK 1
A13019/64	19/64	7.54	0.2969	75.0	156.0	MK 1
A1307.7	–	7.70	0.3031	75.0	156.0	MK 1
A1307.75	–	7.75	0.3051	75.0	156.0	MK 1
A1307.8	–	7.80	0.3071	75.0	156.0	MK 1
A1307.9	–	7.90	0.3110	75.0	156.0	MK 1
A1305/16	5/16	7.94	0.3125	75.0	156.0	MK 1
A1308.0	–	8.00	0.3150	75.0	156.0	MK 1
A1308.1	–	8.10	0.3189	75.0	156.0	MK 1
A1308.2	–	8.20	0.3228	75.0	156.0	MK 1
A1308.25	–	8.25	0.3248	75.0	156.0	MK 1
A1308.3	–	8.30	0.3268	75.0	156.0	MK 1
A13021/64	21/64	8.33	0.3281	75.0	156.0	MK 1
A1308.4	–	8.40	0.3307	75.0	156.0	MK 1
A1308.5	–	8.50	0.3346	75.0	156.0	MK 1
A1308.6	–	8.60	0.3386	81.0	162.0	MK 1
A1308.7	–	8.70	0.3425	81.0	162.0	MK 1
A13011/32	11/32	8.73	0.3438	81.0	162.0	MK 1
A1308.75	–	8.75	0.3445	81.0	162.0	MK 1
A1308.8	–	8.80	0.3465	81.0	162.0	MK 1
A1308.9	–	8.90	0.3504	81.0	162.0	MK 1
A1309.0	–	9.00	0.3543	81.0	162.0	MK 1
A1309.1	–	9.10	0.3583	81.0	162.0	MK 1
A13023/64	23/64	9.13	0.3594	81.0	162.0	MK 1
A1309.2	–	9.20	0.3622	81.0	162.0	MK 1
A1309.25	–	9.25	0.3642	81.0	162.0	MK 1
A1309.3	–	9.30	0.3661	81.0	162.0	MK 1
A1309.5	–	9.50	0.3740	81.0	162.0	MK 1
A1303/8	3/8	9.52	0.3750	87.0	168.0	MK 1
A1309.6	–	9.60	0.3780	87.0	168.0	MK 1
A1309.7	–	9.70	0.3819	87.0	168.0	MK 1
A1309.75	–	9.75	0.3839	87.0	168.0	MK 1
A1309.8	–	9.80	0.3858	87.0	168.0	MK 1



Producto	DC	DC	DC	LCF	OAL	CZC MS
	(inch)	(mm)	(inch)	(mm)	(mm)	
A1309.9	–	9.90	0.3898	87.0	168.0	MK 1
A13025/64	25/64	9.92	0.3906	87.0	168.0	MK 1
A13010.0	–	10.00	0.3937	87.0	168.0	MK 1
A13010.1	–	10.10	0.3976	87.0	168.0	MK 1
A13010.2	–	10.20	0.4016	87.0	168.0	MK 1
A13010.25	–	10.25	0.4035	87.0	168.0	MK 1
A13010.3	–	10.30	0.4055	87.0	168.0	MK 1
A13013/32	13/32	10.32	0.4063	87.0	168.0	MK 1
A13010.5	–	10.50	0.4134	87.0	168.0	MK 1
A13027/64	27/64	10.72	0.4219	94.0	175.0	MK 1
A13010.75	–	10.75	0.4232	94.0	175.0	MK 1
A13010.8	–	10.80	0.4252	94.0	175.0	MK 1
A13010.9	–	10.90	0.4291	94.0	175.0	MK 1
A13011.0	–	11.00	0.4331	94.0	175.0	MK 1
A13011.1	–	11.10	0.4370	94.0	175.0	MK 1
A1307/16	7/16	11.11	0.4375	94.0	175.0	MK 1
A13011.2	–	11.20	0.4409	94.0	175.0	MK 1
A13011.25	–	11.25	0.4429	94.0	175.0	MK 1
A13011.3	–	11.30	0.4449	94.0	175.0	MK 1
A13011.4	–	11.40	0.4488	94.0	175.0	MK 1
A13011.5	–	11.50	0.4528	94.0	175.0	MK 1
A13029/64	29/64	11.51	0.4531	94.0	175.0	MK 1
A13011.6	–	11.60	0.4567	94.0	175.0	MK 1
A13011.7	–	11.70	0.4606	94.0	175.0	MK 1
A13011.75	–	11.75	0.4626	94.0	175.0	MK 1
A13011.8	–	11.80	0.4646	94.0	175.0	MK 1
A13011.9	–	11.90	0.4685	101.0	182.0	MK 1
A13015/32	15/32	11.91	0.4688	101.0	182.0	MK 1
A13012.0	–	12.00	0.4724	101.0	182.0	MK 1
A13012.1	–	12.10	0.4764	101.0	182.0	MK 1
A13012.2	–	12.20	0.4803	101.0	182.0	MK 1
A13012.25	–	12.25	0.4823	101.0	182.0	MK 1
A13031/64	31/64	12.30	0.4844	101.0	182.0	MK 1
A13012.3	–	12.30	0.4843	101.0	182.0	MK 1
A13012.4	–	12.40	0.4882	101.0	182.0	MK 1
A13012.5	–	12.50	0.4921	101.0	182.0	MK 1
A13012.6	–	12.60	0.4961	101.0	182.0	MK 1
A13012.7	–	12.70	0.5000	101.0	182.0	MK 1
A1301/2	1/2	12.70	0.5000	101.0	182.0	MK 1
A13012.75	–	12.75	0.5020	101.0	182.0	MK 1
A13012.8	–	12.80	0.5039	101.0	182.0	MK 1
A13012.9	–	12.90	0.5079	101.0	182.0	MK 1
A13013.0	–	13.00	0.5118	101.0	182.0	MK 1
A13033/64	33/64	13.10	0.5156	101.0	182.0	MK 1
A13013.2	–	13.20	0.5197	101.0	182.0	MK 1
A13013.25	–	13.25	0.5217	108.0	189.0	MK 1
A13017/32	17/32	13.49	0.5313	108.0	189.0	MK 1
A13013.5	–	13.50	0.5315	108.0	189.0	MK 1
A13013.6	–	13.60	0.5354	108.0	189.0	MK 1
A13013.7	–	13.70	0.5394	108.0	189.0	MK 1
A13013.75	–	13.75	0.5413	108.0	189.0	MK 1
A13013.8	–	13.80	0.5433	108.0	189.0	MK 1
A13035/64	35/64	13.89	0.5469	108.0	189.0	MK 1
A13013.9	–	13.90	0.5472	108.0	189.0	MK 1
A13014.0	–	14.00	0.5512	108.0	189.0	MK 1
A13014.1	–	14.10	0.5551	114.0	212.0	MK 2
A13014.2	–	14.20	0.5591	114.0	212.0	MK 2
A13014.25	–	14.25	0.5610	114.0	212.0	MK 2
A1309/16	9/16	14.29	0.5625	114.0	212.0	MK 2
A13014.3	–	14.30	0.5630	114.0	212.0	MK 2
A13014.4	–	14.40	0.5669	114.0	212.0	MK 2
A13014.5	–	14.50	0.5709	114.0	212.0	MK 2



Producto	DC	DC	DC	LCF	OAL	CZC MS
	(inch)	(mm)	(inch)	(mm)	(mm)	
A13014.6	–	14.60	0.5748	114.0	212.0	MK 2
A13037/64	37/64	14.68	0.5781	114.0	212.0	MK 2
A13014.7	–	14.70	0.5787	114.0	212.0	MK 2
A13014.75	–	14.75	0.5807	114.0	212.0	MK 2
A13014.8	–	14.80	0.5827	114.0	212.0	MK 2
A13014.9	–	14.90	0.5866	114.0	212.0	MK 2
A13015.0	–	15.00	0.5906	114.0	212.0	MK 2
A13019/32	19/32	15.08	0.5938	120.0	218.0	MK 2
A13015.1	–	15.10	0.5945	120.0	218.0	MK 2
A13015.2	–	15.20	0.5984	120.0	218.0	MK 2
A13015.25	–	15.25	0.6004	120.0	218.0	MK 2
A13039/64	39/64	15.48	0.6094	120.0	218.0	MK 2
A13015.5	–	15.50	0.6102	120.0	218.0	MK 2
A13015.7	–	15.70	0.6181	120.0	218.0	MK 2
A13015.75	–	15.75	0.6201	120.0	218.0	MK 2
A13015.8	–	15.80	0.6220	120.0	218.0	MK 2
A1305/8	5/8	15.88	0.6250	120.0	218.0	MK 2
A13015.9	–	15.90	0.6260	120.0	218.0	MK 2
A13016.0	–	16.00	0.6299	120.0	218.0	MK 2
A13016.1	–	16.10	0.6339	125.0	223.0	MK 2
A13016.2	–	16.20	0.6378	125.0	223.0	MK 2
A13016.25	–	16.25	0.6398	125.0	223.0	MK 2
A13041/64	41/64	16.27	0.6406	125.0	223.0	MK 2
A13016.5	–	16.50	0.6496	125.0	223.0	MK 2
A13021/32	21/32	16.67	0.6563	125.0	223.0	MK 2
A13016.75	–	16.75	0.6594	125.0	223.0	MK 2
A13017.0	–	17.00	0.6693	125.0	223.0	MK 2
A13043/64	43/64	17.07	0.6719	130.0	228.0	MK 2
A13017.25	–	17.25	0.6791	130.0	228.0	MK 2
A13011/16	11/16	17.46	0.6875	130.0	228.0	MK 2
A13017.5	–	17.50	0.6890	130.0	228.0	MK 2
A13017.75	–	17.75	0.6988	130.0	228.0	MK 2
A13045/64	45/64	17.86	0.7031	130.0	228.0	MK 2
A13018.0	–	18.00	0.7087	130.0	228.0	MK 2
A13018.25	–	18.25	0.7185	135.0	233.0	MK 2
A13023/32	23/32	18.26	0.7188	135.0	233.0	MK 2
A13018.5	–	18.50	0.7283	135.0	233.0	MK 2
A13047/64	47/64	18.65	0.7344	135.0	233.0	MK 2
A13018.75	–	18.75	0.7382	135.0	233.0	MK 2
A13019.0	–	19.00	0.7480	135.0	233.0	MK 2
A1303/4	3/4	19.05	0.7500	140.0	238.0	MK 2
A13019.25	–	19.25	0.7579	140.0	238.0	MK 2
A13049/64	49/64	19.45	0.7656	140.0	238.0	MK 2
A13019.5	–	19.50	0.7677	140.0	238.0	MK 2
A13019.75	–	19.75	0.7776	140.0	238.0	MK 2
A13025/32	25/32	19.84	0.7813	140.0	238.0	MK 2
A13020.0	–	20.00	0.7874	140.0	238.0	MK 2
A13051/64	51/64	20.24	0.7969	145.0	243.0	MK 2
A13020.25	–	20.25	0.7972	145.0	243.0	MK 2
A13020.4	–	20.40	0.8031	145.0	243.0	MK 2
A13020.5	–	20.50	0.8071	145.0	243.0	MK 2
A13013/16	13/16	20.64	0.8125	145.0	243.0	MK 2
A13020.75	–	20.75	0.8169	145.0	243.0	MK 2
A13021.0	–	21.00	0.8268	145.0	243.0	MK 2
A13053/64	53/64	21.03	0.8281	145.0	243.0	MK 2
A13021.25	–	21.25	0.8366	150.0	248.0	MK 2
A13027/32	27/32	21.43	0.8437	150.0	248.0	MK 2
A13021.5	–	21.50	0.8465	150.0	248.0	MK 2
A13021.75	–	21.75	0.8563	150.0	248.0	MK 2
A13055/64	55/64	21.83	0.8594	150.0	248.0	MK 2
A13022.0	–	22.00	0.8661	150.0	248.0	MK 2
A1307/8	7/8	22.22	0.8750	150.0	248.0	MK 2



Producto	DC	DC	DC	LCF	OAL	CZC MS
	(inch)	(mm)	(inch)	(mm)	(mm)	
A13022.25	—	22.25	0.8760	150.0	248.0	MK 2
A13022.5	—	22.50	0.8858	155.0	253.0	MK 2
A13057/64	57/64	22.62	0.8906	155.0	253.0	MK 2
A13022.75	—	22.75	0.8957	155.0	253.0	MK 2
A13023.0	—	23.00	0.9055	155.0	253.0	MK 2
A13029/32	29/32	23.02	0.9063	155.0	253.0	MK 2
A13023.25	—	23.25	0.9154	155.0	276.0	MK 3
A13059/64	59/64	23.42	0.9219	155.0	276.0	MK 3
A13023.5	—	23.50	0.9252	155.0	276.0	MK 3
A13023.75	—	23.75	0.9350	160.0	281.0	MK 3
A13015/16	15/16	23.81	0.9375	160.0	281.0	MK 3
A13024.0	—	24.00	0.9449	160.0	281.0	MK 3
A13061/64	61/64	24.21	0.9531	160.0	281.0	MK 3
A13024.25	—	24.25	0.9547	160.0	281.0	MK 3
A13024.5	—	24.50	0.9646	160.0	281.0	MK 3
A13031/32	31/32	24.61	0.9688	160.0	281.0	MK 3
A13024.75	—	24.75	0.9744	160.0	281.0	MK 3
A13025.0	—	25.00	0.9843	160.0	281.0	MK 3
A13063/64	63/64	25.00	0.9844	160.0	286.0	MK 3
A13025.25	—	25.25	0.9941	165.0	286.0	MK 3
A1301	1"	25.40	1.0000	165.0	286.0	MK 3
A13025.5	—	25.50	1.0039	165.0	286.0	MK 3
A13025.75	—	25.75	1.0138	165.0	286.0	MK 3
A13026.0	—	26.00	1.0236	165.0	286.0	MK 3
A13026.25	—	26.25	1.0335	165.0	286.0	MK 3
A13026.5	—	26.50	1.0433	165.0	286.0	MK 3
A13026.75	—	26.75	1.0531	170.0	291.0	MK 3
A1301.1/16	1.1/16	26.99	1.0625	170.0	291.0	MK 3
A13027.0	—	27.00	1.0630	170.0	291.0	MK 3
A13027.25	—	27.25	1.0728	170.0	291.0	MK 3
A13027.5	—	27.50	1.0827	170.0	291.0	MK 3
A13027.75	—	27.75	1.0925	170.0	291.0	MK 3
A13028.0	—	28.00	1.1024	170.0	291.0	MK 3
A13028.25	—	28.25	1.1122	175.0	296.0	MK 3
A13028.5	—	28.50	1.1220	175.0	296.0	MK 3
A1301.1/8	1.1/8	28.58	1.1250	175.0	296.0	MK 3
A13028.75	—	28.75	1.1319	175.0	296.0	MK 3
A13029.0	—	29.00	1.1417	175.0	296.0	MK 3
A13029.25	—	29.25	1.1516	175.0	296.0	MK 3
A1301.5/32	1.5/32	29.37	1.1563	175.0	296.0	MK 3
A13029.5	—	29.50	1.1614	175.0	296.0	MK 3
A13029.75	—	29.75	1.1713	175.0	296.0	MK 3
A13030.0	—	30.00	1.1811	175.0	296.0	MK 3
A1301.3/16	1.3/16	30.16	1.1875	180.0	301.0	MK 3
A13030.25	—	30.25	1.1909	180.0	301.0	MK 3
A13030.5	—	30.50	1.2008	180.0	301.0	MK 3
A13030.75	—	30.75	1.2106	180.0	301.0	MK 3
A1301.7/32	1.7/32	30.96	1.2188	180.0	301.0	MK 3
A13031.0	—	31.00	1.2205	180.0	301.0	MK 3
A13031.25	—	31.25	1.2303	180.0	301.0	MK 3
A13031.5	—	31.50	1.2402	180.0	301.0	MK 3
A13031.75	—	31.75	1.2500	185.0	306.0	MK 3
A1301.1/4	1.1/4	31.75	1.2500	185.0	306.0	MK 3
A13032.0	—	32.00	1.2598	185.0	334.0	MK 4
A13032.5	—	32.50	1.2795	185.0	334.0	MK 4
A1301.9/32	1.9/32	32.54	1.2813	185.0	334.0	MK 4
A13033.0	—	33.00	1.2992	185.0	334.0	MK 4
A1301.5/16	1.5/16	33.34	1.3125	185.0	334.0	MK 4
A13033.5	—	33.50	1.3189	185.0	334.0	MK 4
A13034.0	—	34.00	1.3386	190.0	339.0	MK 4
A1301.11/32	1.11/32	34.13	1.3438	190.0	339.0	MK 4
A13034.5	—	34.50	1.3583	190.0	339.0	MK 4



Producto	DC	DC	DC	LCF	OAL	CZC MS
	(inch)	(mm)	(inch)	(mm)	(mm)	
A1301.3/8	1.3/8	34.93	1.3750	190.0	339.0	MK 4
A13035.0	–	35.00	1.3780	190.0	339.0	MK 4
A13035.5	–	35.50	1.3976	190.0	339.0	MK 4
A1301.13/32	1.13/32	35.72	1.4063	195.0	344.0	MK 4
A13036.0	–	36.00	1.4173	195.0	344.0	MK 4
A13036.5	–	36.50	1.4370	195.0	344.0	MK 4
A1301.7/16	1.7/16	36.51	1.4375	195.0	344.0	MK 4
A13037.0	–	37.00	1.4567	195.0	344.0	MK 4
A13037.5	–	37.50	1.4764	195.0	344.0	MK 4
A13038.0	–	38.00	1.4961	200.0	349.0	MK 4
A1301.1/2	1.1/2	38.10	1.5000	200.0	349.0	MK 4
A13038.5	–	38.50	1.5157	200.0	349.0	MK 4
A13039.0	–	39.00	1.5354	200.0	349.0	MK 4
A13039.5	–	39.50	1.5551	200.0	349.0	MK 4
A1301.9/16	1.9/16	39.69	1.5625	200.0	349.0	MK 4
A13040.0	–	40.00	1.5748	200.0	349.0	MK 4
A13040.5	–	40.50	1.5945	205.0	354.0	MK 4
A13041.0	–	41.00	1.6142	205.0	354.0	MK 4
A1301.5/8	1.5/8	41.28	1.6250	205.0	354.0	MK 4
A13041.5	–	41.50	1.6339	205.0	354.0	MK 4
A13042.0	–	42.00	1.6535	205.0	354.0	MK 4
A13042.5	–	42.50	1.6732	205.0	354.0	MK 4
A1301.11/16	1.11/16	42.86	1.6875	210.0	359.0	MK 4
A13043.0	–	43.00	1.6929	210.0	359.0	MK 4
A13043.5	–	43.50	1.7126	210.0	359.0	MK 4
A13044.0	–	44.00	1.7323	210.0	359.0	MK 4
A1301.3/4	1.3/4	44.45	1.7500	210.0	359.0	MK 4
A13044.5	–	44.50	1.7520	210.0	359.0	MK 4
A13045.0	–	45.00	1.7717	210.0	359.0	MK 4
A13045.5	–	45.50	1.7913	215.0	364.0	MK 4
A13046.0	–	46.00	1.8110	215.0	364.0	MK 4
A13046.5	–	46.50	1.8307	215.0	364.0	MK 4
A13047.0	–	47.00	1.8504	215.0	364.0	MK 4
A13047.5	–	47.50	1.8701	215.0	364.0	MK 4
A13048.0	–	48.00	1.8898	220.0	369.0	MK 4
A13048.5	–	48.50	1.9094	220.0	369.0	MK 4
A13049.0	–	49.00	1.9291	220.0	369.0	MK 4
A13049.5	–	49.50	1.9488	220.0	369.0	MK 4
A13050.0	–	50.00	1.9685	220.0	369.0	MK 4
A1302	2"	50.80	2.0000	225.0	374.0	MK 4



A530



Broca HSS, Mango Cónico, Recubrimiento TiN

Broca robusta con punta convencional a 118°, fácil de reafilar, que proporciona un mayor rendimiento cuando se usa en máquinas convencionales. Adecuada para taladrar en la mayoría de materiales. El recubrimiento TiN mejora el rendimiento y prolonga la vida útil de la herramienta.

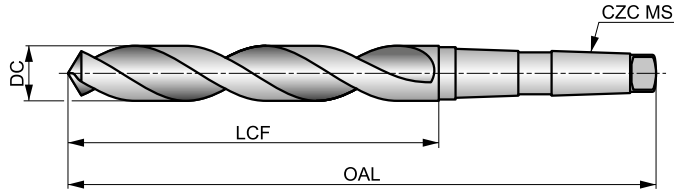

HSS	DIN 345	4xD
118°	TiN	
λ 20-35°	R	DC h8

Grupo de Material de la pieza adecuado y condiciones de velocidad de corte iniciales (m/min) y código de avance alfabético. Tablas con avance por revolución a partir de la pag.175.

P1.1 ■ 40 I	P1.2 ■ 45 I	P1.3 ■ 46 I	P2.1 ■ 34 I	P2.2 ■ 30 F	P2.3 ■ 27 E	P3.1 ■ 29 F	P3.2 ■ 24 F	P3.3 ■ 20 E	P4.1 ■ 18 F	P4.2 ■ 15 E	P4.3 ■ 12 D	M1.1 ■ 33 E	M1.2 ■ 28 E
M2.1 ■ 29 E	M2.2 ■ 24 E	M3.1 ■ 15 G	M3.2 ■ 13 G	M3.3 ■ 12 G	M4.1 ■ 20 C	K1.1 ■ 36 I	K1.2 ■ 27 E	K1.3 ■ 20 E	K2.1 ■ 33 E	K2.2 ■ 27 E	K2.3 ■ 22 E	K3.1 ■ 29 E	K3.2 ■ 22 E
K3.3 ■ 18 E	K4.1 ■ 27 E	K4.2 ■ 21 E	K4.3 ■ 15 E	K4.4 ■ 13 E	K4.5 ■ 11 E	K5.1 ■ 31 E	K5.2 ■ 23 E	K5.3 ■ 18 E	N1.1 ■ 55 I	N1.2 ■ 41 I	N1.3 ■ 28 I	N2.1 ■ 54 G	N2.2 ■ 48 G
N2.3 ■ 35 G	N3.1 ■ 93 G	N3.2 ■ 55 I	N3.3 ■ 28 G	N4.1 ■ 50 J	N4.2 ■ 50 H	N4.3 ■ 35 F	S1.1 ■ 32 F	S1.2 ■ 18 D	S1.3 ■ 13 B	S2.1 ■ 8 E	S2.2 ■ 4 A	S3.1 ■ 6 E	S3.2 ■ 3 A
S4.1 ■ 5 E	S4.2 ■ 2 A												

DC >= 14mm Punta Adelgazada

Producto	DC (mm)	DC (inch)	LCF (mm)	OAL (mm)	CZC MS
A5308.5	8.50	0.3346	75.0	156.0	MK 1
A5309.0	9.00	0.3543	81.0	162.0	MK 1
A53010.0	10.00	0.3937	87.0	168.0	MK 1
A53010.2	10.20	0.4016	87.0	168.0	MK 1
A53010.5	10.50	0.4134	87.0	168.0	MK 1
A53011.0	11.00	0.4331	94.0	175.0	MK 1
A53011.5	11.50	0.4528	94.0	175.0	MK 1
A53011.75	11.75	0.4626	94.0	175.0	MK 1
A53012.0	12.00	0.4724	101.0	182.0	MK 1
A53012.5	12.50	0.4921	101.0	182.0	MK 1
A53013.0	13.00	0.5118	101.0	182.0	MK 1
A53013.5	13.50	0.5315	108.0	189.0	MK 1
A53014.0	14.00	0.5512	108.0	189.0	MK 1
A53014.5	14.50	0.5709	114.0	212.0	MK 2
A53015.0	15.00	0.5906	114.0	212.0	MK 2
A53015.25	15.25	0.6004	120.0	218.0	MK 2
A53015.5	15.50	0.6102	120.0	218.0	MK 2
A53016.0	16.00	0.6299	120.0	218.0	MK 2
A53016.5	16.50	0.6496	125.0	223.0	MK 2
A53017.0	17.00	0.6693	125.0	223.0	MK 2
A53017.5	17.50	0.6890	130.0	228.0	MK 2
A53018.0	18.00	0.7087	130.0	228.0	MK 2
A53018.5	18.50	0.7283	135.0	233.0	MK 2
A53019.0	19.00	0.7480	135.0	233.0	MK 2
A53019.5	19.50	0.7677	140.0	238.0	MK 2
A53020.0	20.00	0.7874	140.0	238.0	MK 2

Producto	DC (mm)	DC (inch)	LCF (mm)	OAL (mm)	CZC MS
A53020.5	20.50	0.8071	145.0	243.0	MK 2
A53021.0	21.00	0.8268	145.0	243.0	MK 2
A53021.5	21.50	0.8465	150.0	248.0	MK 2
A53022.0	22.00	0.8661	150.0	248.0	MK 2
A53022.5	22.50	0.8858	155.0	253.0	MK 2
A53023.0	23.00	0.9055	155.0	253.0	MK 2
A53023.5	23.50	0.9252	155.0	276.0	MK 3
A53024.0	24.00	0.9449	160.0	281.0	MK 3
A53024.5	24.50	0.9646	160.0	281.0	MK 3
A53025.0	25.00	0.9843	160.0	281.0	MK 3
A53025.5	25.50	1.0039	165.0	286.0	MK 3
A53026.0	26.00	1.0236	165.0	286.0	MK 3
A53026.5	26.50	1.0433	165.0	286.0	MK 3
A53027.0	27.00	1.0630	170.0	291.0	MK 3
A53027.5	27.50	1.0827	170.0	291.0	MK 3
A53028.0	28.00	1.1024	170.0	291.0	MK 3
A53028.5	28.50	1.1220	175.0	296.0	MK 3
A53029.0	29.00	1.1417	175.0	296.0	MK 3
A53029.5	29.50	1.1614	175.0	296.0	MK 3
A53030.0	30.00	1.1811	175.0	296.0	MK 3
A53031.0	31.00	1.2205	180.0	301.0	MK 3
A53032.0	32.00	1.2598	185.0	334.0	MK 4
A53033.0	33.00	1.2992	185.0	334.0	MK 4
A53035.0	35.00	1.3780	190.0	339.0	MK 4
A53040.0	40.00	1.5748	200.0	349.0	MK 4



A730

Broca HSS-E (8% Cobalto), Mango Cónico, Acabado Templado Bronce

Recomendada para materiales y aplicaciones difíciles. La punta a 118° proporciona resistencia y es de fácil reafilado. Adecuada para taladrar muchos materiales. El acabado bronce consiste en una fina capa de óxido y es indicativo de cobalto.

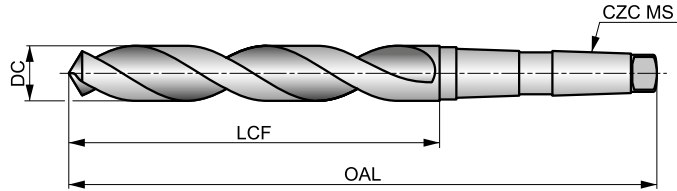

HSS-E	DIN 345	4xD
118°	Bronze	
20-35°	R	DC h8

Grupo de Material de la pieza adecuada y condiciones de velocidad de corte iniciales (m/min) y código de avance alfabético. Tablas con avance por revolución a partir de la pag.175.

P1.1 36 H	P1.2 40 H	P1.3 41 H	P2.1 31 H	P2.2 27 G	P2.3 24 E	P3.1 25 F	P3.2 20 F	P3.3 17 E	P4.1 15 F	P4.2 13 E	P4.3 10 D	M1.1 33 E	M1.2 28 E
M2.1 29 E	M2.2 24 E	M3.1 13 G	M3.2 11 G	M3.3 10 G	M4.1 17 C	K1.1 35 J	K1.2 26 G	K1.3 19 G	K2.1 27 E	K2.2 22 E	K2.3 18 E	K3.1 24 E	K3.2 18 E
K3.3 15 E	K4.1 22 E	K4.2 17 E	K4.3 12 E	K4.4 11 E	K4.5 9 E	K5.1 25 E	K5.2 19 E	K5.3 15 E	N1.1 33 J	N1.2 25 J	N1.3 17 I	N2.1 46 H	N2.2 42 H
N2.3 30 H	N3.1 68 H	N3.2 40 J	N3.3 20 L	N4.1 35 K	N4.2 28 J	N4.3 20 H	S1.1 28 G	S1.2 20 D	S1.3 11 C	S2.1 9 E	S2.2 8 B	S3.1 7 E	S3.2 6 B
S4.1 5 E	S4.2 5 B												

DC >= 14mm Punta Adelgazada

Producto	DC (mm)	DC (inch)	LCF (mm)	OAL (mm)	CZC MS	Producto	DC (mm)	DC (inch)	LCF (mm)	OAL (mm)	CZC MS
A73010.0	10.00	0.3937	87.0	168.0	MK 1	A73016.25	16.25	0.6398	120.0	218.0	MK 2
A73010.2	10.20	0.4016	87.0	168.0	MK 1	A73016.5	16.50	0.6496	125.0	223.0	MK 2
A73010.5	10.50	0.4134	87.0	168.0	MK 1	A73017.0	17.00	0.6693	125.0	223.0	MK 2
A73010.8	10.80	0.4252	94.0	175.0	MK 1	A73017.25	17.25	0.6791	130.0	228.0	MK 2
A73011.0	11.00	0.4331	94.0	175.0	MK 1	A73017.5	17.50	0.6890	130.0	228.0	MK 2
A73011.5	11.50	0.4528	94.0	175.0	MK 1	A73017.75	17.75	0.6988	130.0	228.0	MK 2
A73011.8	11.80	0.4646	94.0	175.0	MK 1	A73018.0	18.00	0.7087	130.0	228.0	MK 2
A73012.0	12.00	0.4724	101.0	182.0	MK 1	A73018.25	18.25	0.7185	135.0	233.0	MK 2
A73012.2	12.20	0.4803	101.0	182.0	MK 1	A73018.5	18.50	0.7283	135.0	233.0	MK 2
A73012.5	12.50	0.4921	101.0	182.0	MK 1	A73018.75	18.75	0.7382	135.0	233.0	MK 2
A73012.8	12.80	0.5039	101.0	182.0	MK 1	A73019.0	19.00	0.7480	135.0	233.0	MK 2
A73013.0	13.00	0.5118	101.0	182.0	MK 1	A73019.25	19.25	0.7579	140.0	238.0	MK 2
A73013.5	13.50	0.5315	108.0	189.0	MK 1	A73019.5	19.50	0.7677	140.0	238.0	MK 2
A73013.8	13.80	0.5433	108.0	189.0	MK 1	A73019.75	19.75	0.7776	140.0	238.0	MK 2
A73014.0	14.00	0.5512	108.0	189.0	MK 1	A73020.0	20.00	0.7874	140.0	238.0	MK 2
A73014.25	14.25	0.5610	114.0	212.0	MK 2	A73020.25	20.25	0.7972	145.0	243.0	MK 2
A73014.5	14.50	0.5709	114.0	212.0	MK 2	A73020.5	20.50	0.8071	145.0	243.0	MK 2
A73014.75	14.75	0.5807	114.0	212.0	MK 2	A73020.75	20.75	0.8169	145.0	243.0	MK 2
A73015.0	15.00	0.5906	114.0	212.0	MK 2	A73021.0	21.00	0.8268	145.0	243.0	MK 2
A73015.25	15.25	0.6004	120.0	218.0	MK 2	A73021.5	21.50	0.8465	150.0	248.0	MK 2
A73015.5	15.50	0.6102	120.0	218.0	MK 2	A73022.0	22.00	0.8661	150.0	248.0	MK 2
A73015.75	15.75	0.6201	120.0	218.0	MK 2	A73022.5	22.50	0.8858	155.0	253.0	MK 2
A73016.0	16.00	0.6299	120.0	218.0	MK 2	A73023.0	23.00	0.9055	155.0	253.0	MK 2



Producto	DC	DC	LCF	OAL	CZC MS
	(mm)	(inch)	(mm)	(mm)	
A73023.5	23.50	0.9252	155.0	276.0	MK 3
A73024.0	24.00	0.9449	160.0	281.0	MK 3
A73024.5	24.50	0.9646	160.0	281.0	MK 3
A73025.0	25.00	0.9843	160.0	281.0	MK 3
A73025.5	25.50	1.0039	165.0	286.0	MK 3
A73026.0	26.00	1.0236	165.0	286.0	MK 3
A73026.5	26.50	1.0433	165.0	286.0	MK 3
A73027.0	27.00	1.0630	170.0	291.0	MK 3

Producto	DC	DC	LCF	OAL	CZC MS
	(mm)	(inch)	(mm)	(mm)	
A73027.5	27.50	1.0827	170.0	291.0	MK 3
A73028.0	28.00	1.1024	170.0	291.0	MK 3
A73028.5	28.50	1.1220	175.0	296.0	MK 3
A73029.0	29.00	1.1417	175.0	296.0	MK 3
A73030.0	30.00	1.1811	175.0	296.0	MK 3
A73031.0	31.00	1.2205	180.0	301.0	MK 3
A73032.0	32.00	1.2598	185.0	334.0	MK 4



A166



Broca HSS, Mango Cónico, con Punta Soldada de Metal Duro, Acabado Templado al Vapor

Punta de metal duro soldada que proporciona el alto rendimiento de una broca de metal duro a una broca con cuerpo de HSS resistente y menos quebradizo. La punta de 118° y 4 facetas mejora el auto-centrado y es fácil de reafilarse, lo que la convierte en una opción económica para taladrar fundición.

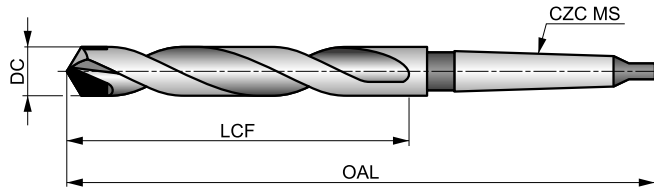

HSS HM	DIN 345	4xD
118°	Bright ST	
20-35°	R	DC h8

Grupo de Material de la pieza adecuado y condiciones de velocidad de corte iniciales (m/min) y código de avance alfabético. Tablas con avance por revolución a partir de la pag.175.

P1.1 73 E	P1.2 82 E	P1.3 85 E	P2.1 63 E	P2.2 55 D	P2.3 49 C	P3.1 59 D	P3.2 47 D	P3.3 40 C	P4.1 35 D	P4.2 30 C	P4.3 24 A	M1.1 55 B	M1.2 46 B
M2.1 49 B	M2.2 40 B	M3.1 41 C	M3.2 35 C	M3.3 32 C	M4.1 35 A	K1.1 50 C	K1.2 37 C	K1.3 28 C	K2.1 43 C	K2.2 35 C	K2.3 28 A	K3.1 38 C	K3.2 29 C
K3.3 24 A	K4.1 35 C	K4.2 27 C	K4.3 20 A	K4.4 17 A	K4.5 14 A	K5.1 40 C	K5.2 30 C	K5.3 23 A	N1.1 50 I	N1.2 38 I	N1.3 25 H	N2.1 62 G	N2.2 55 G
N2.3 40 G	N3.1 127 C	N3.2 75 G	N3.3 38 D	N4.2 60 E	S1.1 35 A	S1.2 35 A	S1.3 25 A	S2.1 33 A	S2.2 28 A	S3.1 25 A	S3.2 20 A	S4.1 20 A	S4.2 16 A

Producto	DC	DC	LCF	OAL	CZC MS	Producto	DC	DC	LCF	OAL	CZC MS
	(mm)	(inch)					(mm)	(mm)			
A16610.0	10.00	0.3937	87.0	168.0	MK 1	A16620.0	20.00	0.7874	140.0	238.0	MK 2
A16610.5	10.50	0.4134	87.0	168.0	MK 1	A16621.0	21.00	0.8268	145.0	243.0	MK 2
A16611.0	11.00	0.4331	94.0	175.0	MK 1	A16622.0	22.00	0.8661	150.0	248.0	MK 2
A16611.5	11.50	0.4528	94.0	175.0	MK 1	A16622.5	22.50	0.8858	155.0	253.0	MK 2
A16612.0	12.00	0.4724	101.0	182.0	MK 1	A16623.0	23.00	0.9055	155.0	253.0	MK 2
A16613.0	13.00	0.5118	101.0	182.0	MK 1	A16624.0	24.00	0.9449	160.0	281.0	MK 3
A16613.5	13.50	0.5315	108.0	189.0	MK 1	A16625.0	25.00	0.9843	160.0	281.0	MK 3
A16614.0	14.00	0.5512	108.0	189.0	MK 1	A16626.0	26.00	1.0236	165.0	286.0	MK 3
A16615.0	15.00	0.5906	114.0	212.0	MK 2	A16627.0	27.00	1.0630	170.0	291.0	MK 3
A16616.0	16.00	0.6299	120.0	218.0	MK 2	A16628.0	28.00	1.1024	170.0	291.0	MK 3
A16617.0	17.00	0.6693	125.0	223.0	MK 2	A16629.0	29.00	1.1417	175.0	296.0	MK 3
A16617.5	17.50	0.6890	130.0	228.0	MK 2	A16630.0	30.00	1.1811	175.0	296.0	MK 3
A16618.0	18.00	0.7087	130.0	228.0	MK 2	A16632.0	32.00	1.2598	185.0	334.0	MK 4
A16619.0	19.00	0.7480	135.0	233.0	MK 2	A16633.0	33.00	1.2992	185.0	334.0	MK 4



A350



Broca HSS, Mango Cónico, Acabado Templado al Vapor

Recomendada para taladrar agujeros profundos o para aplicaciones donde se requiere un mayor alcance. El acabado templado al vapor retiene el fluido de corte y evita la soldadura de la viruta a la herramienta. La punta a 118° proporciona resistencia y es de fácil reafilado. Adecuada para taladrar muchos materiales.

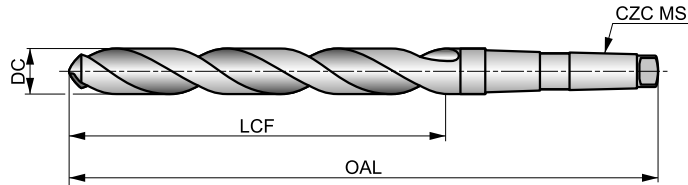

HSS	DIN 341	6xD
118°	ST	
λ 20-35°	R	DC h8

Grupo de Material de la pieza adecuado y condiciones de velocidad de corte iniciales (m/min) y código de avance alfabético. Tablas con avance por revolución a partir de la pag.175.

P1.1 ■ 27 I	P1.2 ■ 30 I	P1.3 ■ 31 I	P2.1 ■ 23 I	P2.2 ■ 20 G	P2.3 ■ 18 E	P3.1 ■ 15 F	P3.2 ■ 12 F	P3.3 ■ 10 E	P4.1 ■ 9 F	P4.2 ■ 7 E	P4.3 ■ 6 D	M1.1 ■ 18 E	M1.2 ■ 15 E
M2.1 ■ 16 E	M2.2 ■ 13 E	M3.1 ■ 5 G	M3.2 ■ 4 G	M3.3 ■ 4 G	M4.1 ■ 8 C	K1.1 ■ 26 I	K1.2 ■ 19 F	K1.3 ■ 14 F	K2.1 ■ 22 E	K2.2 ■ 18 E	K2.3 ■ 14 E	K3.1 ■ 20 E	K3.2 ■ 15 E
K3.3 ■ 12 E	K4.1 ■ 18 E	K4.2 ■ 14 E	K4.3 ■ 10 E	K4.4 ■ 9 E	K4.5 ■ 7 E	K5.1 ■ 21 E	K5.2 ■ 15 E	K5.3 ■ 12 E	N1.1 ■ 33 J	N1.2 ■ 25 J	N1.3 ■ 17 I	N2.1 ■ 42 H	N2.2 ■ 37 H
N2.3 ■ 27 H	N3.1 ■ 59 H	N3.2 ■ 35 I	N3.3 ■ 18 F	N4.1 ■ 35 L	N4.2 ■ 26 J	N4.3 ■ 12 H	S1.1 ■ 16 F	S1.2 ■ 9 D	S1.3 ■ 5 B	S2.1 ■ 5 E	S2.2 ■ 4 A	S3.1 ■ 4 E	S3.2 ■ 3 A
S4.1 ■ 3 E	S4.2 ■ 2 A												

Producto	DC (mm)	DC (inch)	LCF (mm)	OAL (mm)	CZC MS
A3505.0	5.00	0.1969	74.0	155.0	MK 1
A3505.5	5.50	0.2165	80.0	161.0	MK 1
A3506.0	6.00	0.2362	80.0	161.0	MK 1
A3506.7	6.70	0.2638	86.0	167.0	MK 1
A3506.8	6.80	0.2677	93.0	174.0	MK 1
A3507.0	7.00	0.2756	93.0	174.0	MK 1
A3507.5	7.50	0.2953	93.0	174.0	MK 1
A3508.0	8.00	0.3150	100.0	181.0	MK 1
A3508.4	8.40	0.3307	100.0	181.0	MK 1
A3508.5	8.50	0.3346	100.0	181.0	MK 1
A3508.75	8.75	0.3445	107.0	188.0	MK 1
A3509.0	9.00	0.3543	107.0	188.0	MK 1
A3509.5	9.50	0.3740	107.0	188.0	MK 1
A3509.8	9.80	0.3858	116.0	197.0	MK 1
A35010.0	10.00	0.3937	116.0	197.0	MK 1
A35010.2	10.20	0.4016	116.0	197.0	MK 1
A35010.5	10.50	0.4134	116.0	197.0	MK 1
A35010.7	10.70	0.4213	125.0	206.0	MK 1
A35011.0	11.00	0.4331	125.0	206.0	MK 1
A35011.5	11.50	0.4528	125.0	206.0	MK 1
A35011.75	11.75	0.4626	125.0	206.0	MK 1
A35011.8	11.80	0.4646	125.0	206.0	MK 1
A35012.0	12.00	0.4724	134.0	215.0	MK 1
A35012.5	12.50	0.4921	134.0	215.0	MK 1

Producto	DC (mm)	DC (inch)	LCF (mm)	OAL (mm)	CZC MS
A35013.0	13.00	0.5118	134.0	215.0	MK 1
A35013.5	13.50	0.5315	142.0	223.0	MK 1
A35014.0	14.00	0.5512	142.0	223.0	MK 1
A35014.25	14.25	0.5610	147.0	245.0	MK 2
A35014.5	14.50	0.5709	147.0	245.0	MK 2
A35014.75	14.75	0.5807	147.0	245.0	MK 2
A35015.0	15.00	0.5906	147.0	245.0	MK 2
A35015.25	15.25	0.6004	153.0	251.0	MK 2
A35015.5	15.50	0.6102	153.0	251.0	MK 2
A35015.75	15.75	0.6201	153.0	251.0	MK 2
A35016.0	16.00	0.6299	153.0	251.0	MK 2
A35016.25	16.25	0.6398	159.0	257.0	MK 2
A35016.5	16.50	0.6496	159.0	257.0	MK 2
A35016.75	16.75	0.6594	159.0	257.0	MK 2
A35017.0	17.00	0.6693	159.0	257.0	MK 2
A35017.25	17.25	0.6791	165.0	263.0	MK 2
A35017.5	17.50	0.6890	165.0	263.0	MK 2
A35018.0	18.00	0.7087	165.0	263.0	MK 2
A35018.5	18.50	0.7283	171.0	269.0	MK 2
A35019.0	19.00	0.7480	171.0	269.0	MK 2
A35019.5	19.50	0.7677	177.0	275.0	MK 2
A35019.75	19.75	0.7776	177.0	275.0	MK 2
A35020.0	20.00	0.7874	177.0	275.0	MK 2
A35020.25	20.25	0.7972	184.0	282.0	MK 2



Producto	DC	DC	LCF	OAL	CZC MS
	(mm)	(inch)	(mm)	(mm)	
A35020.5	20.50	0.8071	184.0	282.0	MK 2
A35021.0	21.00	0.8268	184.0	282.0	MK 2
A35021.5	21.50	0.8465	191.0	289.0	MK 2
A35022.0	22.00	0.8661	191.0	289.0	MK 2
A35022.5	22.50	0.8858	198.0	296.0	MK 2
A35023.0	23.00	0.9055	198.0	296.0	MK 2
A35023.5	23.50	0.9252	198.0	319.0	MK 3
A35024.0	24.00	0.9449	206.0	327.0	MK 3
A35024.5	24.50	0.9646	206.0	327.0	MK 3
A35025.0	25.00	0.9843	206.0	327.0	MK 3
A35025.5	25.50	1.0039	214.0	335.0	MK 3
A35026.0	26.00	1.0236	214.0	335.0	MK 3
A35026.5	26.50	1.0433	214.0	335.0	MK 3
A35027.0	27.00	1.0630	222.0	343.0	MK 3
A35027.5	27.50	1.0827	222.0	343.0	MK 3
A35028.0	28.00	1.1024	222.0	343.0	MK 3
A35029.0	29.00	1.1417	230.0	351.0	MK 3
A35030.0	30.00	1.1811	230.0	351.0	MK 3
A35030.5	30.50	1.2008	239.0	360.0	MK 3
A35031.0	31.00	1.2205	239.0	360.0	MK 3

Producto	DC	DC	LCF	OAL	CZC MS
	(mm)	(inch)	(mm)	(mm)	
A35031.5	31.50	1.2402	239.0	360.0	MK 3
A35032.0	32.00	1.2598	248.0	397.0	MK 4
A35033.0	33.00	1.2992	248.0	397.0	MK 4
A35034.0	34.00	1.3386	257.0	406.0	MK 4
A35035.0	35.00	1.3780	257.0	406.0	MK 4
A35036.0	36.00	1.4173	267.0	416.0	MK 4
A35037.0	37.00	1.4567	267.0	416.0	MK 4
A35038.0	38.00	1.4961	277.0	426.0	MK 4
A35039.0	39.00	1.5354	277.0	426.0	MK 4
A35040.0	40.00	1.5748	277.0	426.0	MK 4
A35041.0	41.00	1.6142	287.0	436.0	MK 4
A35042.0	42.00	1.6535	287.0	436.0	MK 4
A35043.0	43.00	1.6929	298.0	447.0	MK 4
A35044.0	44.00	1.7323	298.0	447.0	MK 4
A35045.0	45.00	1.7717	298.0	447.0	MK 4
A35046.0	46.00	1.8110	310.0	459.0	MK 4
A35047.0	47.00	1.8504	310.0	459.0	MK 4
A35048.0	48.00	1.8898	321.0	470.0	MK 4
A35050.0	50.00	1.9685	321.0	470.0	MK 4



A345



Broca HSS, Serie Extra Larga DIN 1870-1, Acabado Brillante

Recomendada para taladrar agujeros muy profundos y para aplicaciones donde se necesita un alcance adicional. La punta a 118° proporciona resistencia y es de fácil reafilado. El acabado templado al vapor retiene el fluido de corte y evita la soldadura de la viruta a la herramienta. Adecuada para taladrar muchos materiales.

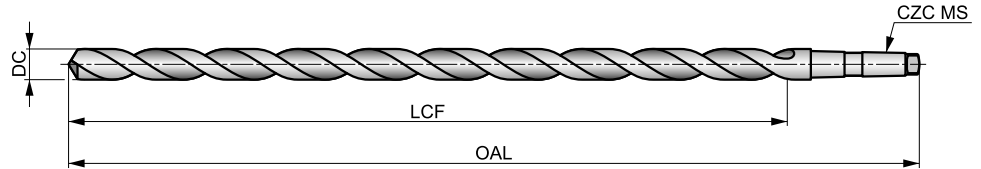

HSS	DIN 1870(1)	10xD
118°	ST	
λ 20-35°	R	DC h8

Grupo de Material de la pieza adecuado y condiciones de velocidad de corte iniciales (m/min) y código de avance alfabético. Tablas con avance por revolución a partir de la pag.175.

P1.1 ■ 23 G	P1.2 ■ 25 G	P1.3 ■ 26 G	P2.1 ■ 19 G	P2.2 ■ 17 E	P2.3 ■ 15 C	P3.1 ■ 9 D	P3.2 ■ 7 D	P3.3 ■ 6 C	P4.1 ■ 5 D	P4.2 ■ 4 C	P4.3 ■ 4 B	M1.1 ■ 16 C	M1.2 ■ 14 C
M2.1 ■ 15 C	M2.2 ■ 12 C	M3.1 ■ 5 E	M3.2 ■ 4 E	M3.3 ■ 4 E	M4.1 ■ 8 A	K1.1 ■ 22 G	K1.2 ■ 16 D	K1.3 ■ 12 D	K2.1 ■ 16 C	K2.2 ■ 13 C	K2.3 ■ 10 C	K3.1 ■ 14 C	K3.2 ■ 11 C
K3.3 ■ 9 C	K4.1 ■ 13 C	K4.2 ■ 10 C	K4.3 ■ 7 C	K4.4 ■ 6 C	K4.5 ■ 5 C	K5.1 ■ 15 C	K5.2 ■ 11 C	K5.3 ■ 9 C	N1.1 ■ 33 H	N1.2 ■ 25 H	N1.3 ■ 17 G	N2.1 ■ 42 F	N2.2 ■ 37 F
N2.3 ■ 27 F	N3.1 ■ 56 F	N3.2 ■ 33 G	N3.3 ■ 17 D	N4.1 ■ 30 J	N4.2 ■ 30 H	N4.3 ■ 10 F	S1.1 ■ 15 D	S1.2 ■ 9 B	S1.3 ■ 5 A	S2.1 ■ 5 C	S2.2 ■ 4 A	S3.1 ■ 4 C	S3.2 ■ 3 A
S4.1 ■ 3 C	S4.2 ■ 2 A												

DC > 25.4mm menos de 10xD.

Producto	DC (inch)	DC (mm)	DC (inch)	LCF (mm)	OAL (mm)	CZC MS
A3458.0	-	8.00	0.3150	165.0	265.0	MK 1
A3458.5	-	8.50	0.3346	165.0	265.0	MK 1
A3459.0	-	9.00	0.3543	175.0	275.0	MK 1
A3459.5	-	9.50	0.3740	175.0	275.0	MK 1
A3453/8	3/8	9.52	0.3750	185.0	285.0	MK 1
A34510.0	-	10.00	0.3937	185.0	285.0	MK 1
A34513/32	13/32	10.32	0.4063	185.0	285.0	MK 1
A34510.5	-	10.50	0.4134	185.0	285.0	MK 1
A34511.0	-	11.00	0.4331	195.0	300.0	MK 1
A3457/16	7/16	11.11	0.4375	195.0	300.0	MK 1
A34511.5	-	11.50	0.4528	195.0	300.0	MK 1
A34529/64	29/64	11.51	0.4531	205.0	310.0	MK 1
A34512.0	-	12.00	0.4724	205.0	310.0	MK 1
A34512.5	-	12.50	0.4921	205.0	310.0	MK 1
A3451/2	1/2	12.70	0.5000	205.0	310.0	MK 1
A34513.0	-	13.00	0.5118	205.0	310.0	MK 1
A34517/32	17/32	13.49	0.5313	220.0	325.0	MK 1
A34513.5	-	13.50	0.5315	220.0	325.0	MK 1
A34514.0	-	14.00	0.5512	220.0	325.0	MK 1
A3459/16	9/16	14.29	0.5625	220.0	340.0	MK 2
A34537/64	37/64	14.68	0.5781	220.0	340.0	MK 2
A34515.0	-	15.00	0.5906	220.0	340.0	MK 2
A34539/64	39/64	15.48	0.6094	230.0	355.0	MK 2

Producto	DC (inch)	DC (mm)	DC (inch)	LCF (mm)	OAL (mm)	CZC MS
A34515.5	-	15.50	0.6102	230.0	355.0	MK 2
A3455/8	5/8	15.88	0.6250	230.0	355.0	MK 2
A34516.0	-	16.00	0.6299	230.0	355.0	MK 2
A34541/64	41/64	16.27	0.6406	230.0	355.0	MK 2
A34516.5	-	16.50	0.6496	230.0	355.0	MK 2
A34521/32	21/32	16.67	0.6563	230.0	355.0	MK 2
A34517.0	-	17.00	0.6693	230.0	355.0	MK 2
A34511/16	11/16	17.46	0.6875	245.0	370.0	MK 2
A34517.5	-	17.50	0.6890	245.0	370.0	MK 2
A34518.0	-	18.00	0.7087	245.0	370.0	MK 2
A34518.5	-	18.50	0.7283	245.0	370.0	MK 2
A34519.0	-	19.00	0.7480	245.0	370.0	MK 2
A3453/4	3/4	19.05	0.7500	260.0	385.0	MK 2
A34519.5	-	19.50	0.7677	260.0	385.0	MK 2
A34520.0	-	20.00	0.7874	260.0	385.0	MK 2
A34520.5	-	20.50	0.8071	260.0	385.0	MK 2
A34521.0	-	21.00	0.8268	260.0	385.0	MK 2
A34521.5	-	21.50	0.8465	270.0	405.0	MK 2
A34522.0	-	22.00	0.8661	270.0	405.0	MK 2
A3457/8	7/8	22.22	0.8750	270.0	405.0	MK 2
A34522.5	-	22.50	0.8858	270.0	405.0	MK 3
A34523.0	-	23.00	0.9055	270.0	405.0	MK 3
A34523.5	-	23.50	0.9252	270.0	425.0	MK 3



Producto	DC	DC	DC	LCF	OAL	CZC MS
	(inch)	(mm)	(inch)	(mm)	(mm)	
A34524.0	–	24.00	0.9449	290.0	440.0	MK 3
A34524.5	–	24.50	0.9646	290.0	440.0	MK 3
A34525.0	–	25.00	0.9843	290.0	440.0	MK 3
A3451	1"	25.40	1.0000	290.0	440.0	MK 3
A34525.5	–	25.50	1.0039	290.0	440.0	MK 3
A34526.0	–	26.00	1.0236	290.0	440.0	MK 3
A34526.5	–	26.50	1.0433	290.0	440.0	MK 3
A34527.0	–	27.00	1.0630	305.0	460.0	MK 3
A34528.0	–	28.00	1.1024	305.0	460.0	MK 3
A34529.0	–	29.00	1.1417	305.0	460.0	MK 3
A34530.0	–	30.00	1.1811	305.0	460.0	MK 3
A3451.1/4	1.1/4	31.75	1.2500	320.0	480.0	MK 3

Producto	DC	DC	DC	LCF	OAL	CZC MS
	(inch)	(mm)	(inch)	(mm)	(mm)	
A34531.0	–	31.00	1.2205	320.0	480.0	MK 3
A34532.0	–	32.00	1.2598	320.0	505.0	MK 4
A34533.0	–	33.00	1.2992	320.0	505.0	MK 4
A34534.0	–	34.00	1.3386	340.0	530.0	MK 4
A34535.0	–	35.00	1.3780	340.0	530.0	MK 4
A34536.0	–	36.00	1.4173	340.0	530.0	MK 4
A34537.0	–	37.00	1.4567	340.0	530.0	MK 4
A34538.0	–	38.00	1.4961	360.0	555.0	MK 4
A3451.1/2	1.1/2	38.10	1.5000	360.0	555.0	MK 4
A34539.0	–	39.00	1.5354	360.0	555.0	MK 4
A34540.0	–	40.00	1.5748	360.0	555.0	MK 4



A951



Broca HSS PFX Serie Extra Larga, Mango Cónico (DIN 1870/1), Acabado Brillante, Hélice Rápida

Broca con diseño especial parabólico de los canales diseñada para taladrar agujeros profundos en una sola pasada. Tiene punta autocentrante a 130° (se recomienda centrar con una broca PFX corta) por lo que se reduce la fuerza necesaria para producir el agujero. Apta para la mayoría de materiales.

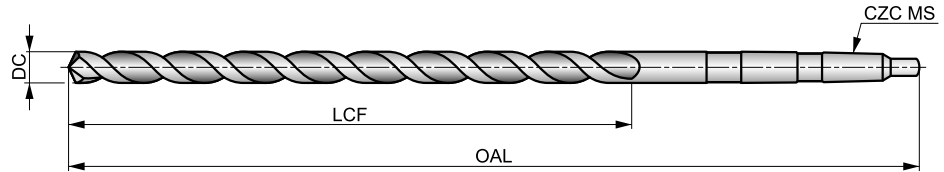

HSS	DIN 1870(1)	15×D
130°	Bright ST	
λ > 35°	R	DC h8

Grupo de Material de la pieza adecuado y condiciones de velocidad de corte iniciales (m/min) y código de avance alfabético. Tablas con avance por revolución a partir de la pag.175.

P1.1 ■ 25 G	P1.2 ■ 28 G	P1.3 ■ 29 G	P2.1 ■ 22 G	P2.2 ■ 19 E	P2.3 ■ 17 C	P3.1 ■ 12 D	P3.2 ■ 9 D	P3.3 ■ 8 C	P4.1 ■ 7 D	P4.2 ■ 6 C	P4.3 ■ 5 B	M1.1 ■ 16 C	M1.2 ■ 14 C
M2.1 ■ 15 C	M2.2 ■ 12 C	M3.1 ■ 7 E	M3.2 ■ 6 E	M3.3 ■ 5 E	M4.1 ■ 12 A	K1.1 ■ 22 G	K1.2 ■ 16 D	K1.3 ■ 12 D	K2.1 ■ 16 C	K2.2 ■ 13 C	K2.3 ■ 10 C	K3.1 ■ 14 C	K3.2 ■ 11 C
K3.3 ■ 9 C	K4.1 ■ 13 C	K4.2 ■ 10 C	K4.3 ■ 7 C	K4.4 ■ 6 C	K4.5 ■ 5 C	K5.1 ■ 15 C	K5.2 ■ 11 C	K5.3 ■ 9 C	N1.1 ■ 30 H	N1.2 ■ 23 H	N1.3 ■ 15 G	N2.1 ■ 37 F	N2.2 ■ 33 F
N2.3 ■ 24 F	N3.1 ■ 56 F	N3.2 ■ 33 G	N3.3 ■ 17 D	N4.1 ■ 30 J	N4.2 ■ 30 H	N4.3 ■ 10 F	S1.1 ■ 18 D	S1.2 ■ 10 B	S1.3 ■ 6 A	S2.1 ■ 7 C	S2.2 ■ 4 A	S3.1 ■ 5 C	S3.2 ■ 3 A
S4.1 ■ 4 C	S4.2 ■ 2 A												

DC >= 14.5mm menos de 15xD; DC > 23mm Brillante

Producto	DC (mm)	DC (inch)	LCF (mm)	OAL (mm)	CZC MS
A95110.0	10.00	0.3937	185.0	285.0	MK 1
A95111.0	11.00	0.4331	195.0	300.0	MK 1
A95112.0	12.00	0.4724	205.0	310.0	MK 1
A95112.5	12.50	0.4921	205.0	310.0	MK 1
A95113.0	13.00	0.5118	205.0	310.0	MK 1
A95113.5	13.50	0.5315	220.0	325.0	MK 1
A95114.0	14.00	0.5512	220.0	325.0	MK 1
A95114.5	14.50	0.5709	220.0	340.0	MK 2
A95115.0	15.00	0.5906	220.0	340.0	MK 2
A95115.5	15.50	0.6102	230.0	355.0	MK 2
A95116.0	16.00	0.6299	230.0	355.0	MK 2
A95116.5	16.50	0.6496	230.0	355.0	MK 2
A95117.0	17.00	0.6693	230.0	355.0	MK 2
A95117.5	17.50	0.6890	245.0	370.0	MK 2
A95118.0	18.00	0.7087	245.0	370.0	MK 2

Producto	DC (mm)	DC (inch)	LCF (mm)	OAL (mm)	CZC MS
A95118.5	18.50	0.7283	245.0	370.0	MK 2
A95119.0	19.00	0.7480	245.0	370.0	MK 2
A95119.5	19.50	0.7677	260.0	385.0	MK 2
A95120.0	20.00	0.7874	260.0	385.0	MK 2
A95121.0	21.00	0.8268	260.0	385.0	MK 2
A95122.0	22.00	0.8661	270.0	405.0	MK 2
A95123.0	23.00	0.9055	270.0	405.0	MK 2
A95124.0	24.00	0.9449	290.0	440.0	MK 3
A95125.0	25.00	0.9843	290.0	440.0	MK 3
A95126.0	26.00	1.0236	290.0	440.0	MK 3
A95127.0	27.00	1.0630	305.0	460.0	MK 3
A95128.0	28.00	1.1024	305.0	460.0	MK 3
A95129.0	29.00	1.1417	305.0	460.0	MK 3
A95130.0	30.00	1.1811	305.0	460.0	MK 3



A952



Broca HSS PFX Serie Extra Larga, Mango Cónico (DIN 1870/2), Acabado Brillante, Hélice Rápida

Broca con diseño especial parabólico de los canales diseñada para taladrar agujeros profundos en una sola pasada. Tiene punta autocentrante a 130° (se recomienda centrar con una broca PFX corta) por lo que se reduce la fuerza necesaria para producir el agujero. Apta para la mayoría de materiales.

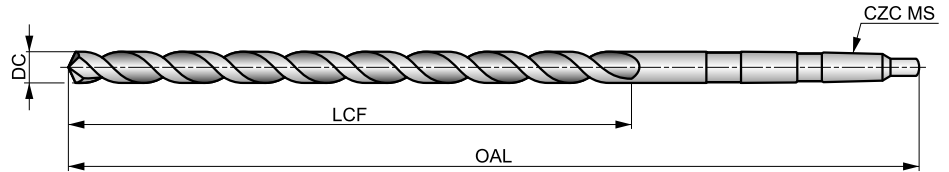

HSS	DIN 1870(2)	20xD
130°	Bright ST	
$\lambda > 35^\circ$	R	DC h8

Grupo de Material de la pieza adecuado y condiciones de velocidad de corte iniciales (m/min) y código de avance alfabético. Tablas con avance por revolución a partir de la pag.175.

P1.1 ■ 25 G	P1.2 ■ 28 G	P1.3 ■ 29 G	P2.1 ■ 22 G	P2.2 ■ 19 E	P2.3 ■ 17 C	P3.1 ■ 12 D	P3.2 ■ 9 D	P3.3 ■ 8 C	P4.1 ■ 7 D	P4.2 ■ 6 C	P4.3 ■ 5 B	M1.1 ■ 16 C	M1.2 ■ 14 C
M2.1 ■ 15 C	M2.2 ■ 12 C	M3.1 ■ 17 E	M3.2 ■ 16 E	M3.3 ■ 5 E	M4.1 ■ 12 A	K1.1 ■ 22 G	K1.2 ■ 16 D	K1.3 ■ 12 D	K2.1 ■ 16 C	K2.2 ■ 13 C	K2.3 ■ 10 C	K3.1 ■ 14 C	K3.2 ■ 11 C
K3.3 ■ 9 C	K4.1 ■ 13 C	K4.2 ■ 10 C	K4.3 ■ 7 C	K4.4 ■ 6 C	K4.5 ■ 5 C	K5.1 ■ 15 C	K5.2 ■ 11 C	K5.3 ■ 9 C	N1.1 ■ 30 H	N1.2 ■ 23 H	N1.3 ■ 15 G	N2.1 ■ 37 F	N2.2 ■ 33 F
N2.3 ■ 24 F	N3.1 ■ 56 F	N3.2 ■ 33 G	N3.3 ■ 17 D	N4.1 ■ 30 J	N4.2 ■ 30 H	N4.3 ■ 10 F	S1.1 ■ 18 D	S1.2 ■ 10 B	S1.3 ■ 6 A	S2.1 ■ 7 C	S2.2 ■ 4 A	S3.1 ■ 5 C	S3.2 ■ 3 A
S4.1 ■ 4 C	S4.2 ■ 2 A												

DC >= 14.5mm menos de 20xD; DC > 23mm Brillante

Producto	DC (mm)	DC (inch)	LCF (mm)	OAL (mm)	CZC MS
A9528.0	8.00	0.3150	210.0	330.0	MK 1
A9528.5	8.50	0.3346	210.0	330.0	MK 1
A9529.0	9.00	0.3543	220.0	345.0	MK 1
A95210.0	10.00	0.3937	235.0	360.0	MK 1
A95210.5	10.50	0.4134	235.0	360.0	MK 1
A95211.0	11.00	0.4331	250.0	375.0	MK 1
A95211.5	11.50	0.4528	250.0	375.0	MK 1
A95212.0	12.00	0.4724	260.0	395.0	MK 1
A95212.5	12.50	0.4921	260.0	395.0	MK 1
A95213.0	13.00	0.5118	260.0	395.0	MK 1
A95213.5	13.50	0.5315	275.0	410.0	MK 1
A95214.0	14.00	0.5512	275.0	410.0	MK 1
A95214.5	14.50	0.5709	275.0	425.0	MK 2
A95215.0	15.00	0.5906	275.0	425.0	MK 2
A95215.5	15.50	0.6102	295.0	445.0	MK 2
A95216.0	16.00	0.6299	295.0	445.0	MK 2
A95216.5	16.50	0.6496	295.0	445.0	MK 2
A95217.0	17.00	0.6693	295.0	445.0	MK 2
A95217.5	17.50	0.6890	310.0	465.0	MK 2
A95218.0	18.00	0.7087	310.0	465.0	MK 2
A95218.5	18.50	0.7283	310.0	465.0	MK 2
A95219.0	19.00	0.7480	310.0	465.0	MK 2
A95219.5	19.50	0.7677	325.0	490.0	MK 2
A95220.0	20.00	0.7874	325.0	490.0	MK 2
A95221.0	21.00	0.8268	325.0	490.0	MK 2
A95222.0	22.00	0.8661	345.0	515.0	MK 2
A95223.0	23.00	0.9055	345.0	515.0	MK 2
A95224.0	24.00	0.9449	365.0	555.0	MK 3
A95225.0	25.00	0.9843	365.0	555.0	MK 3
A95226.0	26.00	1.0236	365.0	555.0	MK 3
A95227.0	27.00	1.0630	385.0	580.0	MK 3
A95228.0	28.00	1.1024	385.0	580.0	MK 3
A95229.0	29.00	1.1417	385.0	580.0	MK 3
A95230.0	30.00	1.1811	385.0	580.0	MK 3
A95231.0	31.00	1.2205	410.0	610.0	MK 3
A95232.0	32.00	1.2598	410.0	635.0	MK 4
A95233.0	33.00	1.2992	410.0	635.0	MK 4
A95234.0	34.00	1.3386	430.0	665.0	MK 4
A95235.0	35.00	1.3780	430.0	665.0	MK 4
A95238.0	38.00	1.4961	460.0	695.0	MK 4
A95240.0	40.00	1.5748	460.0	695.0	MK 4



A400



Broca HSS Bidiametral a 90°, Acabado Templado al Vapor

Una herramienta versátil, diseñada para taladrar agujeros pasantes achaflanados para tornillos métricos estándar. Punta a 118° y avellanado a 90°. Adecuada para máquinas convencionales y CNC. El acabado templado al vapor actúa reteniendo el fluido de corte y evitando que la viruta se sude a la herramienta. Adecuada para taladrar la mayoría de materiales.

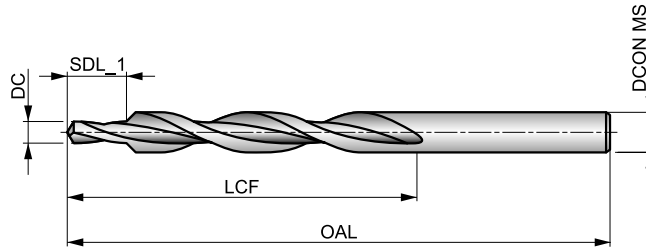

HSS	DIN 8374	4xD
90°	ST	
λ 20-35°	R	118°

Grupo de Material de la pieza adecuado y condiciones de velocidad de corte iniciales (m/min) y código de avance alfabético. Tablas con avance por revolución a partir de la pag.175.

P1.1 ■ 29 G	P1.2 ■ 33 G	P1.3 ■ 34 G	P2.1 ■ 25 G	P2.2 ■ 22 E	P2.3 ■ 19 C	P3.1 ■ 15 E	P3.2 ■ 12 E	P3.3 ■ 10 C	P4.1 ■ 9 E	P4.2 ■ 7 C	P4.3 ■ 6 C	M1.1 ■ 22 E	M1.2 ■ 19 E
M2.1 ■ 20 E	M2.2 ■ 16 E	M3.1 ■ 10 G	M3.2 ■ 9 G	M3.3 ■ 8 G	M4.1 ■ 12 C	K1.1 ■ 30 G	K1.2 ■ 22 E	K1.3 ■ 17 E	K2.1 ■ 23 E	K2.2 ■ 19 E	K2.3 ■ 15 C	K3.1 ■ 21 E	K3.2 ■ 16 E
K3.3 ■ 13 C	K4.1 ■ 19 E	K4.2 ■ 14 E	K4.3 ■ 11 C	K4.4 ■ 9 C	K4.5 ■ 8 C	K5.1 ■ 22 E	K5.2 ■ 16 E	K5.3 ■ 13 C	N1.1 ■ 45 E	N1.2 ■ 34 E	N1.3 ■ 23 E	N2.1 ■ 49 E	N2.2 ■ 44 E
N2.3 ■ 32 E	N3.1 ■ 68 E	N3.2 ■ 40 E	N3.3 ■ 20 E	N4.1 ■ 30 I	S1.1 ■ 23 E	S1.2 ■ 14 C	S1.3 ■ 8 A	S2.1 ■ 8 C	S2.2 ■ 6 A	S3.1 ■ 6 C	S3.2 ■ 4 A	S4.1 ■ 5 C	S4.2 ■ 3 A

Producto	TDZ	DC (mm)	DC (inch)	LCF (mm)	OAL (mm)	SDL_1 (mm)	DCON MS (mm)
A400M3	M3	3.20	0.1260	57.0	93.0	9.00	6.00
A400M4	M4	4.30	0.1693	75.0	117.0	11.00	8.00
A400M5	M5	5.30	0.2087	87.0	133.0	13.00	10.00
A400M6	M6	6.40	0.2520	94.0	142.0	15.00	11.50
A400M8	M8	8.40	0.3307	114.0	169.0	19.00	15.00
A400M10	M10	10.50	0.4134	135.0	198.0	23.00	19.00



A402



Broca HSS Escalonada, Acabado Templado al Vapor

Incluye un piloto a 118° y un avellanado a 180° con diámetro y longitud de piloto específicos, recomendados para crear agujeros pasantes avellanados para tornillos métricos estándar. El acabado templado al vapor retiene el fluido de corte y evita la soldadura de la viruta a la herramienta. Adecuada para taladrar muchos materiales.

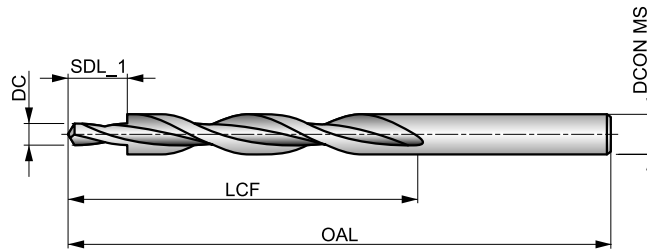

HSS	DIN 8376	4xD
180°	ST	
λ 20-35°	R	118°

Grupo de Material de la pieza adecuada y condiciones de velocidad de corte iniciales (m/min) y código de avance alfabético. Tablas con avance por revolución a partir de la pag.175.

P1.1 ■ 29 G	P1.2 ■ 33 G	P1.3 ■ 34 G	P2.1 ■ 25 G	P2.2 ■ 22 E	P2.3 ■ 19 C	P3.1 ■ 15 E	P3.2 ■ 12 E	P3.3 ■ 10 C	P4.1 ■ 9 E	P4.2 ■ 17 C	P4.3 ■ 16 C	M1.1 ■ 22 E	M1.2 ■ 19 E
M2.1 ■ 20 E	M2.2 ■ 16 E	M3.1 ■ 10 G	M3.2 ■ 9 G	M3.3 ■ 8 G	M4.1 ■ 12 C	K1.1 ■ 30 G	K1.2 ■ 22 E	K1.3 ■ 17 E	K2.1 ■ 23 E	K2.2 ■ 19 E	K2.3 ■ 15 C	K3.1 ■ 21 E	K3.2 ■ 16 E
K3.3 ■ 13 C	K4.1 ■ 19 E	K4.2 ■ 14 E	K4.3 ■ 11 C	K4.4 ■ 9 C	K4.5 ■ 8 C	K5.1 ■ 22 E	K5.2 ■ 16 E	K5.3 ■ 13 C	N1.1 ■ 45 E	N1.2 ■ 34 E	N1.3 ■ 23 E	N2.1 ■ 49 E	N2.2 ■ 44 E
N2.3 ■ 32 E	N3.1 ■ 68 E	N3.2 ■ 40 E	N3.3 ■ 20 E	N4.1 ■ 30 I	S1.1 ■ 23 E	S1.2 ■ 14 C	S1.3 ■ 8 A	S2.1 ■ 8 C	S2.2 ■ 6 A	S3.1 ■ 6 C	S3.2 ■ 4 A	S4.1 ■ 5 C	S4.2 ■ 3 A

Producto	TDZ	DC	DC	LCF	OAL	SDL_1	DCON MS
		(mm)	(inch)				
A402M3	M3	3.40	0.1339	57.0	93.0	9.00	6.00
A402M4	M4	4.50	0.1772	75.0	117.0	11.00	8.00
A402M5	M5	5.50	0.2165	87.0	133.0	13.00	10.00
A402M6	M6	6.60	0.2598	94.0	142.0	15.00	11.00
A402M8	M8	9.00	0.3543	114.0	169.0	19.00	15.00
A402M10	M10	11.00	0.4331	130.0	191.0	23.00	18.00



A405



Broca Escalonada HSS, Mango Cónico, Acabado Templado al Vapor

Una herramienta versátil recomendada para producir agujeros avellanados para tornillos métricos estándar. Piloto a 118° y avellanado a 180°. Adecuada para máquinas convencionales y CNC. El acabado templado al vapor actúa reteniendo el fluido de corte y evitando que la viruta se suelde a la herramienta. Adecuada para taladrar la mayoría de materiales.

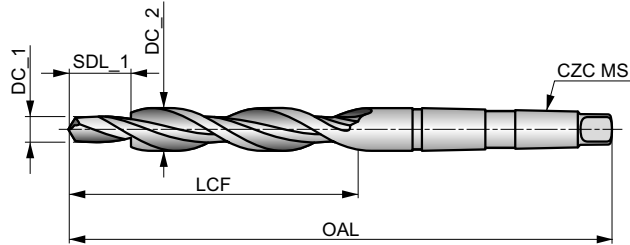

HSS	DIN 8377	4xD
180°	ST	
λ 20-35°	R	118°

Grupo de Material de la pieza adecuado y condiciones de velocidad de corte iniciales (m/min) y código de avance alfabético. Tablas con avance por revolución a partir de la pag.175.

P1.1 ■ 29 G	P1.2 ■ 33 G	P1.3 ■ 34 G	P2.1 ■ 25 G	P2.2 ■ 22 E	P2.3 ■ 19 C	P3.1 ■ 15 E	P3.2 ■ 12 E	P3.3 ■ 10 C	P4.1 ■ 9 E	P4.2 ■ 7 C	P4.3 ■ 6 C	M1.1 ■ 22 E	M1.2 ■ 19 E
M2.1 ■ 20 E	M2.2 ■ 16 E	M3.1 ■ 10 G	M3.2 ■ 9 G	M3.3 ■ 8 G	M4.1 ■ 12 C	K1.1 ■ 30 G	K1.2 ■ 22 E	K1.3 ■ 17 E	K2.1 ■ 23 E	K2.2 ■ 19 E	K2.3 ■ 15 C	K3.1 ■ 21 E	K3.2 ■ 16 E
K3.3 ■ 13 C	K4.1 ■ 19 E	K4.2 ■ 14 E	K4.3 ■ 11 C	K4.4 ■ 9 C	K4.5 ■ 8 C	K5.1 ■ 22 E	K5.2 ■ 16 E	K5.3 ■ 13 C	N1.1 ■ 45 E	N1.2 ■ 34 E	N1.3 ■ 23 E	N2.1 ■ 49 E	N2.2 ■ 44 E
N2.3 ■ 32 E	N3.1 ■ 68 E	N3.2 ■ 40 E	N3.3 ■ 20 E	N4.1 ■ 30 I	S1.1 ■ 23 E	S1.2 ■ 14 C	S1.3 ■ 8 A	S2.1 ■ 8 C	S2.2 ■ 6 A	S3.1 ■ 6 C	S3.2 ■ 4 A	S4.1 ■ 5 C	S4.2 ■ 3 A

Producto	TDZ	DC_1 (mm)	DC_1 (inch)	DC_2 (mm)	LCF (mm)	OAL (mm)	SDL_1 (mm)	CZC MS
A405M6	M6	6.60	0.2598	11.00	94.0	175.0	15.00	MK 1
A405M8	M8	9.00	0.3543	15.00	114.0	212.0	19.00	MK 2
A405M10	M10	11.00	0.4331	18.00	130.0	228.0	23.00	MK 2
A405M12	M12	13.50	0.5315	20.00	140.0	238.0	27.00	MK 2
A405M14	M14	15.50	0.6102	24.00	160.0	281.0	31.00	MK 3
A405M16	M16	17.50	0.6890	26.00	165.0	286.0	35.00	MK 3
A405M18	M18	20.00	0.7874	30.00	175.0	296.0	39.00	MK 3



A412



Broca HSS Escalonada, Acabado Templado al Vapor

Diseñada para producir agujeros avellanados para tornillos métricos estándar. Punta a 118° y chaflán a 90°. El acabado templado al vapor actúa reteniendo el fluido de corte y evitando que la viruta se suelde a la herramienta. Adecuada para taladrar la mayoría de materiales. Adecuada para máquinas convencionales y CNC.

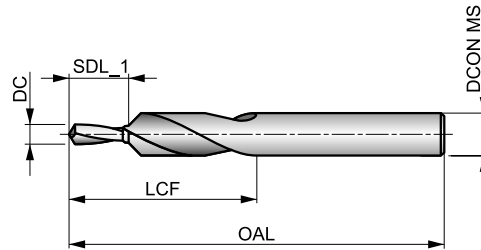

HSS	DORMER	2.5×D
90°	ST	
R	118°	

Grupo de Material de la pieza adecuada y condiciones de velocidad de corte iniciales (m/min) y código de avance alfabético. Tablas con avance por revolución a partir de la pag.175.

P1.1 ■ 29 I	P1.2 ■ 33 I	P1.3 ■ 34 I	P2.1 ■ 25 I	P2.2 ■ 22 G	P2.3 ■ 19 E	P3.1 ■ 15 G	P3.2 ■ 12 G	P3.3 ■ 10 E	P4.1 ■ 9 G	P4.2 ■ 7 E	P4.3 ■ 6 C	M1.1 ■ 22 G	M1.2 ■ 19 G
M2.1 ■ 20 G	M2.2 ■ 16 G	M3.1 ■ 10 I	M3.2 ■ 9 I	M3.3 ■ 8 I	M4.1 ■ 12 E	K1.1 ■ 30 G	K1.2 ■ 22 E	K1.3 ■ 17 E	K2.1 ■ 23 E	K2.2 ■ 19 E	K2.3 ■ 15 E	K3.1 ■ 21 E	K3.2 ■ 16 E
K3.3 ■ 13 E	K4.1 ■ 19 E	K4.2 ■ 14 E	K4.3 ■ 11 E	K4.4 ■ 9 E	K4.5 ■ 8 E	K5.1 ■ 22 E	K5.2 ■ 16 E	K5.3 ■ 13 E	N1.1 ■ 45 G	N1.2 ■ 34 G	N1.3 ■ 23 G	N2.1 ■ 42 G	N2.2 ■ 37 G
N2.3 ■ 27 G	N3.1 ■ 68 G	N3.2 ■ 40 G	N3.3 ■ 20 G	N4.1 ■ 30 I	S1.1 ■ 27 G	S1.2 ■ 16 E	S1.3 ■ 8 C	S2.1 ■ 11 G	S2.2 ■ 6 C	S3.1 ■ 8 G	S3.2 ■ 4 C	S4.1 ■ 6 G	S4.2 ■ 3 C

Producto	TDZ	DC	DC	LCF	OAL	SDL_1	DCON MS
		(mm)	(inch)				
A412M3	M3	3.40	0.1339	31.0	70.0	9.00	6.60
A412M4	M4	4.50	0.1772	40.0	84.0	11.00	9.00
A412M5	M5	5.50	0.2165	47.0	95.0	13.00	11.00
A412M6	M6	6.60	0.2598	51.0	102.0	15.00	13.00
A412M8	M8	9.00	0.3543	62.0	123.0	19.00	17.20
A412M10	M10	11.00	0.4331	70.0	141.0	23.00	21.50



A413



Broca HSS Escalonada, Acabado Templado al Vapor

Una herramienta versátil recomendada para producir agujeros avellanados para tornillos métricos estándar. Piloto a 118° y avellanado a 180°. El acabado templado al vapor actúa reteniendo el fluido de corte y evitando que la viruta se suelde a la herramienta. Adecuada para taladrar la mayoría de materiales. Adecuada para máquinas convencionales y CNC.

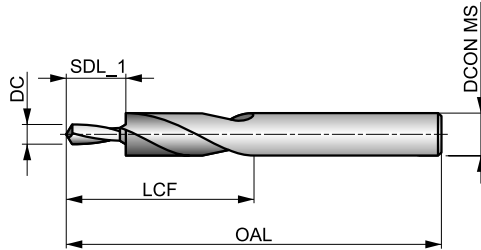

HSS	DORMER	2.5xD
180°	ST	
R	118°	

Grupo de Material de la pieza adecuado y condiciones de velocidad de corte iniciales (m/min) y código de avance alfabético. Tablas con avance por revolución a partir de la pag.175.

P1.1 ■ 29 I	P1.2 ■ 33 I	P1.3 ■ 34 I	P2.1 ■ 25 I	P2.2 ■ 22 G	P2.3 ■ 19 E	P3.1 ■ 15 G	P3.2 ■ 12 G	P3.3 ■ 10 E	P4.1 ■ 9 G	P4.2 ■ 7 E	P4.3 ■ 6 C	M1.1 ■ 22 G	M1.2 ■ 19 G
M2.1 ■ 20 G	M2.2 ■ 16 G	M3.1 ■ 10 I	M3.2 ■ 9 I	M3.3 ■ 8 I	M4.1 ■ 12 E	K1.1 ■ 30 G	K1.2 ■ 22 E	K1.3 ■ 17 E	K2.1 ■ 23 E	K2.2 ■ 19 E	K2.3 ■ 15 E	K3.1 ■ 21 E	K3.2 ■ 16 E
K3.3 ■ 13 E	K4.1 ■ 19 E	K4.2 ■ 14 E	K4.3 ■ 11 E	K4.4 ■ 9 E	K4.5 ■ 8 E	K5.1 ■ 22 E	K5.2 ■ 16 E	K5.3 ■ 13 E	N1.1 ■ 45 G	N1.2 ■ 34 G	N1.3 ■ 23 G	N2.1 ■ 42 G	N2.2 ■ 37 G
N2.3 ■ 27 G	N3.1 ■ 68 G	N3.2 ■ 40 G	N3.3 ■ 20 G	N4.1 ■ 30 I	S1.1 ■ 27 G	S1.2 ■ 16 E	S1.3 ■ 8 C	S2.1 ■ 11 G	S2.2 ■ 6 C	S3.1 ■ 8 G	S3.2 ■ 4 C	S4.1 ■ 6 G	S4.2 ■ 3 C

Producto	TDZ	DC (mm)	DC (inch)	LCF (mm)	OAL (mm)	SDL_1 (mm)	DCON MS (mm)
A413M3	M3	3.40	0.1339	28.0	66.0	9.00	6.00
A413M4	M4	4.50	0.1772	37.0	79.0	11.00	8.00
A413M5	M5	5.50	0.2165	43.0	89.0	13.00	10.00
A413M6	M6	6.60	0.2598	47.0	95.0	15.00	11.00
A413M8	M8	9.00	0.3543	56.0	111.0	19.00	15.00
A413M10	M10	11.00	0.4331	62.0	123.0	23.00	18.00



A200



Broca de Centrar HSS con punta a 118° y Chablán a 60°, Acabado Brillante

Recomendada para iniciar un agujero preciso en el extremo de un eje para poder sujetarlo de forma segura antes del mecanizado. Las puntas a ambos lados aumentan la productividad por herramienta. Adecuada para taladrar la mayoría de materiales.

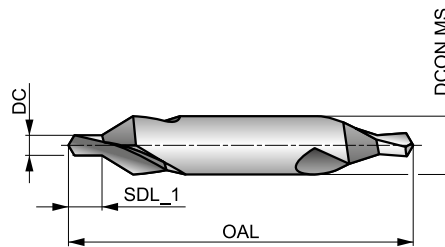

HSS	DIN 333A	1×D
60°	Bright	
R	118°	

Grupo de Material de la pieza adecuado y condiciones de velocidad de corte iniciales (m/min) y código de avance alfabético. Tablas con avance por revolución a partir de la pag.175.

P1.1 ■ 33 I	P1.2 ■ 37 I	P1.3 ■ 38 I	P2.1 ■ 28 I	P2.2 ■ 25 G	P2.3 ■ 22 E	P3.1 ■ 19 F	P3.2 ■ 15 F	P3.3 ■ 13 E	P4.1 ■ 11 F	P4.2 ■ 10 E	P4.3 ■ 8 D	M1.1 ■ 21 E	M1.2 ■ 17 E
M2.1 ■ 18 E	M2.2 ■ 15 E	M3.1 ■ 9 G	M3.2 ■ 8 G	M3.3 ■ 7 G	M4.1 ■ 10 C	K1.1 ■ 30 I	K1.2 ■ 22 F	K1.3 ■ 17 F	K2.1 ■ 25 E	K2.2 ■ 20 E	K2.3 ■ 16 E	K3.1 ■ 22 E	K3.2 ■ 17 E
K3.3 ■ 13 E	K4.1 ■ 20 E	K4.2 ■ 15 E	K4.3 ■ 11 E	K4.4 ■ 10 E	K4.5 ■ 8 E	K5.1 ■ 23 E	K5.2 ■ 17 E	K5.3 ■ 13 E	N1.1 ■ 33 J	N1.2 ■ 25 J	N1.3 ■ 17 I	N2.1 ■ 42 H	N2.2 ■ 37 H
N2.3 ■ 27 H	N3.1 ■ 56 H	N3.2 ■ 33 I	N3.3 ■ 17 G	N4.1 ■ 30 J	N4.2 ■ 28 H	N4.3 ■ 14 F	S1.1 ■ 24 F	S1.2 ■ 13 D	S1.3 ■ 7 B	S2.1 ■ 7 E	S2.2 ■ 6 A	S3.1 ■ 5 E	S3.2 ■ 4 A
S4.1 ■ 4 E	S4.2 ■ 3 A												

Los productos de esta serie también están disponibles en forma de Set. Por favor, vea A296.

Producto	DC (mm)	DC (inch)	SDL_1 (mm)	OAL (mm)	DCON MS (mm)
A200.5X3.15 ¹⁾	0.50	0.0197	0.9 - 0.6	25.0	3.15
A200.8X3.15 ¹⁾	0.80	0.0315	1.3 - 1.0	25.0	3.15
A2001.0X3.15	1.00	0.0394	1.7 - 1.3	31.0	3.15
A2001.25X3.15	1.25	0.0492	2.0 - 1.6	31.0	3.15
A2001.6X4.0	1.60	0.0630	2.6 - 2.0	35.0	4.00
A2002.0X5.0	2.00	0.0787	3.1 - 2.5	40.0	5.00
A2002.5X6.3	2.50	0.0984	3.8 - 3.1	45.0	6.30
A2003.15X8.0	3.15	0.1240	4.6 - 3.9	50.0	8.00
A2004.0X10.0	4.00	0.1575	5.9 - 5.0	55.0	10.00
A2005.0X12.5	5.00	0.1969	7.2 - 6.3	63.0	12.50
A2006.3X16.0	6.30	0.2480	8.9 - 8.0	71.0	16.00
A2008.0X20.0	8.00	0.3150	11.1 - 10.1	80.0	20.00
A20010.0X25.0	10.00	0.3937	13.8 - 12.8	100.0	25.00
A20012.5X31.5	12.50	0.4921	17.5 - 16.5	125.0	31.50

¹⁾ Una sola punta



A205



Broca de Centrar HSS con Punta a 118° y Chafilán a 60°, Recubrimiento TiN

Recomendada para iniciar un agujero preciso en el extremo de un eje para poder sujetarlo de forma segura antes del mecanizado. Las puntas a ambos lados aumentan la productividad por herramienta. El recubrimiento TiN mejora el rendimiento y prolonga la vida útil de la herramienta. Adecuada para taladrar la mayoría de materiales.

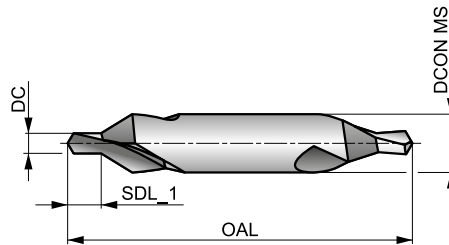

HSS	DIN 333A	1xD
60°	TiN	
R	118°	

Grupo de Material de la pieza adecuado y condiciones de velocidad de corte iniciales (m/min) y código de avance alfabético. Tablas con avance por revolución a partir de la pag.175.

P1.1 ■ 40 I	P1.2 ■ 45 I	P1.3 ■ 46 I	P2.1 ■ 34 I	P2.2 ■ 30 G	P2.3 ■ 27 E	P3.1 ■ 24 F	P3.2 ■ 19 F	P3.3 ■ 16 E	P4.1 ■ 14 F	P4.2 ■ 12 E	P4.3 ■ 10 D	M1.1 ■ 25 E	M1.2 ■ 21 E
M2.1 ■ 22 E	M2.2 ■ 18 E	M3.1 ■ 12 G	M3.2 ■ 10 G	M3.3 ■ 9 G	M4.1 ■ 12 C	K1.1 ■ 36 I	K1.2 ■ 27 F	K1.3 ■ 20 F	K2.1 ■ 30 E	K2.2 ■ 24 E	K2.3 ■ 19 E	K3.1 ■ 26 E	K3.2 ■ 20 E
K3.3 ■ 16 E	K4.1 ■ 24 E	K4.2 ■ 18 E	K4.3 ■ 13 E	K4.4 ■ 11 E	K4.5 ■ 10 E	K5.1 ■ 27 E	K5.2 ■ 21 E	K5.3 ■ 16 E	N1.1 ■ 40 J	N1.2 ■ 30 J	N1.3 ■ 20 I	N2.1 ■ 49 H	N2.2 ■ 44 H
N2.3 ■ 32 H	N3.1 ■ 68 H	N3.2 ■ 40 I	N3.3 ■ 20 G	N4.1 ■ 36 J	N4.2 ■ 34 H	N4.3 ■ 17 F	S1.1 ■ 29 F	S1.2 ■ 16 D	S1.3 ■ 8 B	S2.1 ■ 8 E	S2.2 ■ 7 A	S3.1 ■ 6 E	S3.2 ■ 5 A
S4.1 ■ 5 E	S4.2 ■ 4 A												

Producto	DC	DC	SDL_1	OAL	DCON MS
	(mm)	(inch)			
A2051.0X3.15	1.00	0.0394	1.7 - 1.3	31.0	3.15
A2051.25X3.15	1.25	0.0492	2.0 - 1.6	31.0	3.15
A2051.6X4.0	1.60	0.0630	2.6 - 2.0	35.0	4.00
A2052.0X5.0	2.00	0.0787	3.1 - 2.5	40.0	5.00
A2052.5X6.3	2.50	0.0984	3.8 - 3.1	45.0	6.30
A2053.15X8.0	3.15	0.1240	4.6 - 3.9	50.0	8.00
A2054.0X10.0	4.00	0.1575	5.9 - 5.0	55.0	10.00
A2055.0X12.5	5.00	0.1969	7.2 - 6.3	63.0	12.50



A206



Broca de Centrar HSS con punta a 118° y Chablán a 60°, Acabado Brillante

Recomendada para iniciar un agujero preciso en el extremo de un eje para poder sujetarlo de forma segura antes del mecanizado. Las puntas a ambos lados aumentan la productividad por herramienta. Adecuada para taladrar la mayoría de materiales.

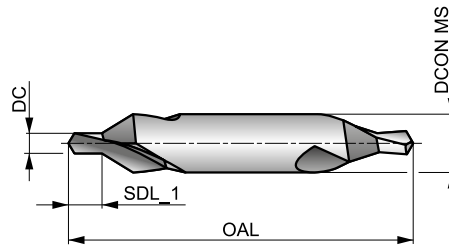

HSS-E	DIN 333A	1xD
60°	Bright	
R	118°	

Grupo de Material de la pieza adecuado y condiciones de velocidad de corte iniciales (m/min) y código de avance alfabético. Tablas con avance por revolución a partir de la pag.175.

P1.1 ■ 40 I	P1.2 ■ 45 I	P1.3 ■ 46 I	P2.1 ■ 34 I	P2.2 ■ 30 G	P2.3 ▣ 27 E	P3.1 ■ 24 F	P3.2 ■ 19 F	P3.3 ▣ 16 E	P4.1 ■ 14 F	P4.2 ▣ 12 E	P4.3 ▣ 10 D	M1.1 ▣ 25 E	M1.2 ▣ 21 E
M2.1 ▣ 22 E	M2.2 ▣ 18 E	M3.1 ▣ 12 G	M3.2 ▣ 10 G	M3.3 ▣ 9 G	M4.1 ▣ 12 C	K1.1 ■ 36 I	K1.2 ■ 27 F	K1.3 ■ 20 F	K2.1 ▣ 30 E	K2.2 ▣ 24 E	K2.3 ▣ 19 E	K3.1 ▣ 26 E	K3.2 ▣ 20 E
K3.3 ▣ 16 E	K4.1 ▣ 24 E	K4.2 ▣ 18 E	K4.3 ▣ 13 E	K4.4 ▣ 11 E	K4.5 ▣ 10 E	K5.1 ▣ 27 E	K5.2 ▣ 21 E	K5.3 ▣ 16 E	N1.1 ▣ 40 J	N1.2 ▣ 30 J	N1.3 ▣ 20 I	N2.1 ▣ 49 H	N2.2 ▣ 44 H
N2.3 ▣ 32 H	N3.1 ▣ 68 H	N3.2 ▣ 40 I	N3.3 ▣ 20 G	N4.1 ▣ 36 J	N4.2 ▣ 34 H	N4.3 ▣ 17 F	S1.1 ▣ 29 F	S1.2 ▣ 16 D	S1.3 ▣ 8 B	S2.1 ▣ 8 E	S2.2 ▣ 7 A	S3.1 ▣ 6 E	S3.2 ▣ 5 A
S4.1 ▣ 5 E	S4.2 ▣ 4 A												

Producto	DC	DC	SDL_1	OAL	DCON MS
	(mm)	(inch)			
A2061.0X3.15	1.00	0.0394	1.7 - 1.3	31.0	3.15
A2061.25X3.15	1.25	0.0492	2.0 - 1.6	31.0	3.15
A2061.6X4.0	1.60	0.0630	2.6 - 2.0	35.0	4.00
A2062.0X5.0	2.00	0.0787	3.1 - 2.5	40.0	5.00
A2062.5X6.3	2.50	0.0984	3.8 - 3.1	45.0	6.30
A2063.15X8.0	3.15	0.1240	4.6 - 3.9	50.0	8.00
A2064.0X10.0	4.00	0.1575	5.9 - 5.0	55.0	10.00
A2065.0X12.5	5.00	0.1969	7.2 - 6.3	63.0	12.50



A266



Broca de Centrar HSS-E con Guía Piloto a 118° y Chaflán a 60°, Recubrimiento TiAlN

Recomendada para iniciar un agujero preciso en el extremo de un eje para poder sujetarlo de forma segura antes del mecanizado. Las puntas a ambos lados aumentan la productividad por herramienta. El recubrimiento TiAlN mejora el rendimiento y prolonga la vida útil de la herramienta. Adecuada para taladrar la mayoría de materiales.

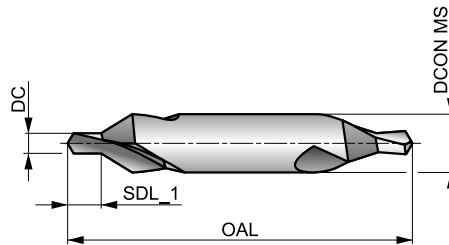

HSS-E	DIN 333A	1xD
60°	TiAlN	
R	118°	

Grupo de Material de la pieza adecuado y condiciones de velocidad de corte iniciales (m/min) y código de avance alfabético. Tablas con avance por revolución a partir de la pag.175.

P1.1 ■ 40 I	P1.2 ■ 45 I	P1.3 ■ 46 I	P2.1 ■ 34 I	P2.2 ■ 30 G	P2.3 ■ 27 E	P3.1 ■ 24 F	P3.2 ■ 19 F	P3.3 ■ 16 E	P4.1 ■ 14 F	P4.2 ■ 12 E	P4.3 ■ 10 D	M1.1 ■ 25 E	M1.2 ■ 21 E
M2.1 ■ 22 E	M2.2 ■ 18 E	M3.1 ■ 12 G	M3.2 ■ 10 G	M3.3 ■ 9 G	M4.1 ■ 12 C	K1.1 ■ 36 I	K1.2 ■ 27 F	K1.3 ■ 20 F	K2.1 ■ 30 E	K2.2 ■ 24 E	K2.3 ■ 19 E	K3.1 ■ 26 E	K3.2 ■ 20 E
K3.3 ■ 16 E	K4.1 ■ 24 E	K4.2 ■ 18 E	K4.3 ■ 13 E	K4.4 ■ 11 E	K4.5 ■ 10 E	K5.1 ■ 27 E	K5.2 ■ 21 E	K5.3 ■ 16 E	N1.1 ■ 40 J	N1.2 ■ 30 J	N1.3 ■ 20 I	N2.1 ■ 49 H	N2.2 ■ 44 H
N2.3 ■ 32 H	N3.1 ■ 68 H	N3.2 ■ 40 I	N3.3 ■ 20 G	N4.1 ■ 36 J	N4.2 ■ 34 H	N4.3 ■ 17 F	S1.1 ■ 29 F	S1.2 ■ 16 D	S1.3 ■ 8 B	S2.1 ■ 8 E	S2.2 ■ 7 A	S3.1 ■ 6 E	S3.2 ■ 5 A
S4.1 ■ 5 E	S4.2 ■ 4 A												

Producto	DC	DC	SDL_1	OAL	DCON MS
	(mm)	(inch)	(mm)	(mm)	(mm)
A2661.0X3.15	1.00	0.0394	1.7 - 1.3	31.0	3.15
A2661.25X3.15	1.25	0.0492	2.0 - 1.6	31.0	3.15
A2661.6X4.0	1.60	0.0630	2.6 - 2.0	35.0	4.00
A2662.0X5.0	2.00	0.0787	3.1 - 2.5	40.0	5.00
A2662.5X6.3	2.50	0.0984	3.8 - 3.1	45.0	6.30
A2663.15X8.0	3.15	0.1240	4.6 - 3.9	50.0	8.00
A2664.0X10.0	4.00	0.1575	5.9 - 5.0	55.0	10.00
A2665.0X12.5	5.00	0.1969	7.2 - 6.3	63.0	12.50



A210

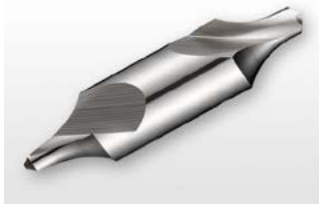

Broca de Centrar HSS con punta a 118° y Chaflán Cóncavo, Acabado Brillante

Recomendada para iniciar un agujero preciso en el extremo de un eje para poder sujetarlo de forma segura antes del mecanizado. Las puntas a ambos lados aumentan la productividad por herramienta. Adecuada para taladrar la mayoría de materiales.

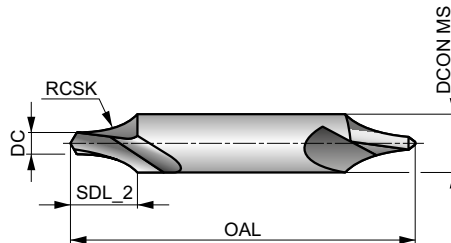

HSS	DIN 333R	1×D
R	Bright	
R	118°	

Grupo de Material de la pieza adecuada y condiciones de velocidad de corte iniciales (m/min) y código de avance alfabético. Tablas con avance por revolución a partir de la pag.175.

P1.1 ■ 33 I	P1.2 ■ 37 I	P1.3 ■ 38 I	P2.1 ■ 28 I	P2.2 ■ 25 G	P2.3 ■ 22 E	P3.1 ■ 19 F	P3.2 ■ 15 F	P3.3 ■ 13 E	P4.1 ■ 11 F	P4.2 ■ 10 E	P4.3 ■ 8 D	M1.1 ■ 21 E	M1.2 ■ 17 E
M2.1 ■ 18 E	M2.2 ■ 15 E	M3.1 ■ 9 G	M3.2 ■ 8 G	M3.3 ■ 7 G	M4.1 ■ 10 C	K1.1 ■ 30 I	K1.2 ■ 22 F	K1.3 ■ 17 F	K2.1 ■ 25 E	K2.2 ■ 20 E	K2.3 ■ 16 E	K3.1 ■ 22 E	K3.2 ■ 17 E
K3.3 ■ 13 E	K4.1 ■ 20 E	K4.2 ■ 15 E	K4.3 ■ 11 E	K4.4 ■ 10 E	K4.5 ■ 8 E	K5.1 ■ 23 E	K5.2 ■ 17 E	K5.3 ■ 13 E	N1.1 ■ 33 J	N1.2 ■ 25 J	N1.3 ■ 17 I	N2.1 ■ 42 H	N2.2 ■ 37 H
N2.3 ■ 27 H	N3.1 ■ 56 H	N3.2 ■ 33 I	N3.3 ■ 17 G	N4.1 ■ 30 J	N4.2 ■ 28 H	N4.3 ■ 14 F	S1.1 ■ 24 F	S1.2 ■ 13 D	S1.3 ■ 7 B	S2.1 ■ 7 E	S2.2 ■ 6 A	S3.1 ■ 5 E	S3.2 ■ 4 A
S4.1 ■ 4 E	S4.2 ■ 3 A												

Producto	DC	DC	SDL_2	OAL	RCSR	DCON MS
	(mm)	(inch)	(mm)	(mm)	(mm)	(mm)
A210.5X3.15 ¹⁾	0.50	0.0197	2.6 - 2.3	25.0	2.50 - 2.00	3.15
A210.8X3.15 ¹⁾	0.80	0.0315	2.9 - 2.6	25.0	3.15 - 2.50	3.15
A2101.0X3.15	1.00	0.0394	3.3 - 3.0	31.0	3.65 - 2.90	3.15
A2101.25X3.15	1.25	0.0492	3.6 - 3.3	31.0	3.95 - 3.15	3.15
A2101.6X4.0	1.60	0.0630	4.7 - 4.2	35.0	5.00 - 4.00	4.00
A2102.0X5.0	2.00	0.0787	5.4 - 5.0	40.0	6.25 - 5.00	5.00
A2102.5X6.3	2.50	0.0984	6.8 - 6.3	45.0	7.88 - 6.30	6.30
A2103.15X8.0	3.15	0.1240	8.5 - 8.0	50.0	10.00 - 8.00	8.00
A2104.0X10.0	4.00	0.1575	10.6 - 10.0	55.0	12.50 - 10.00	10.00
A2105.0X12.5	5.00	0.1969	13.1 - 12.5	63.0	15.63 - 12.50	12.50
A2106.3X16.0	6.30	0.2480	16.6 - 16.0	71.0	20.00 - 16.00	16.00
A2108.0X20.0	8.00	0.3150	20.7 - 20.0	80.0	25.00 - 20.00	20.00
A21010.0X25.0	10.00	0.3937	25.7 - 25.0	100.0	31.25 - 25.00	25.00

¹⁾ Una sola punta



A201



Broca de Centrar HSS con punta a 122° y Chablán a 60°, Acabado Brillante

Recomendada para iniciar un agujero preciso en el extremo de un eje para poder sujetarlo de forma segura antes del mecanizado. Las puntas a ambos lados aumentan la productividad por herramienta. Adecuada para taladrar la mayoría de materiales.

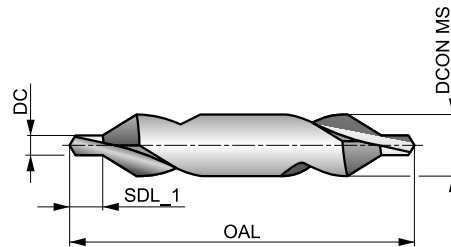

HSS	DORMER	1xD
60°	Bright	
R	122°	

Grupo de Material de la pieza adecuado y condiciones de velocidad de corte iniciales (m/min) y código de avance alfabético. Tablas con avance por revolución a partir de la pag.175.

P1.1 ■ 33 I	P1.2 ■ 37 I	P1.3 ■ 38 I	P2.1 ■ 28 I	P2.2 ■ 25 G	P2.3 ■ 22 E	P3.1 ■ 19 F	P3.2 ■ 15 F	P3.3 ■ 13 E	P4.1 ■ 11 F	P4.2 ■ 10 E	P4.3 ■ 8 D	M1.1 ■ 21 E	M1.2 ■ 17 E
M2.1 ■ 18 E	M2.2 ■ 15 E	M3.1 ■ 9 G	M3.2 ■ 8 G	M3.3 ■ 7 G	M4.1 ■ 10 C	K1.1 ■ 30 I	K1.2 ■ 22 F	K1.3 ■ 17 F	K2.1 ■ 25 E	K2.2 ■ 20 E	K2.3 ■ 16 E	K3.1 ■ 22 E	K3.2 ■ 17 E
K3.3 ■ 13 E	K4.1 ■ 20 E	K4.2 ■ 15 E	K4.3 ■ 11 E	K4.4 ■ 10 E	K4.5 ■ 8 E	K5.1 ■ 23 E	K5.2 ■ 17 E	K5.3 ■ 13 E	N1.1 ■ 33 J	N1.2 ■ 25 J	N1.3 ■ 17 I	N2.1 ■ 42 H	N2.2 ■ 37 H
N2.3 ■ 27 H	N3.1 ■ 56 H	N3.2 ■ 33 I	N3.3 ■ 17 G	N4.1 ■ 30 J	N4.2 ■ 28 H	N4.3 ■ 14 F	S1.1 ■ 24 F	S1.2 ■ 13 D	S1.3 ■ 7 B	S2.1 ■ 7 E	S2.2 ■ 6 A	S3.1 ■ 5 E	S3.2 ■ 4 A
S4.1 ■ 4 E	S4.2 ■ 3 A												

Producto	DC (mm)	DC (inch)	SDL_1 (mm)	OAL (mm)	DCON MS (mm)
A201.63X3.15 ¹⁾	0.63	0.0248	1.2 - 0.9	20.0	3.15
A201.75X3.5	0.75	0.0295	1.3 - 1.0	35.0	3.50
A2011.0X4.0	1.00	0.0394	2.1 - 1.5	35.0	4.00
A2011.5X5.0	1.50	0.0591	2.8 - 2.0	40.0	5.00
A2011.6X5.0	1.60	0.0630	2.4 - 2.0	40.0	5.00
A2012.0X6.0	2.00	0.0787	4.0 - 3.0	45.0	6.00
A2012.0X6.3	2.00	0.0787	2.9 - 2.5	45.0	6.30
A2012.5X8.0	2.50	0.0984	4.5 - 3.5	50.0	8.00
A2013.0X8.0	3.00	0.1181	4.4 - 3.9	50.0	8.00
A2013.0X10.0	3.00	0.1181	5.0 - 4.0	56.0	10.00
A2013.15X10.0	3.15	0.1240	4.4 - 3.9	56.0	10.00
A2014.0X12.0	4.00	0.1575	6.2 - 5.0	66.0	12.00
A2015.0X14.0	5.00	0.1969	7.7 - 6.5	78.0	14.00
A2016.0X18.0	6.00	0.2362	9.2 - 8.0	90.0	18.00

¹⁾ Una sola punta



A225



Broca de Centrar HSS, Ángulo de la punta a 120° y chaflán a 60°, Acabado Brillante

Recomendada para iniciar un agujero preciso en el extremo de un eje para poder sujetarlo de forma segura antes del mecanizado. Norma British Standard 328. Las puntas a ambos lados aumentan la productividad por herramienta. Adecuada para taladrar la mayoría de materiales.

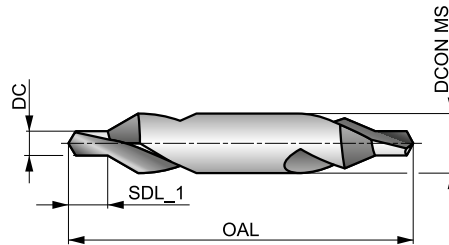

HSS	BS 328	1×D
60°	Bright	
R	120°	

Grupo de Material de la pieza adecuado y condiciones de velocidad de corte iniciales (m/min) y código de avance alfabético. Tablas con avance por revolución a partir de la pag.175.

P1.1 ■ 33 I	P1.2 ■ 37 I	P1.3 ■ 38 I	P2.1 ■ 28 I	P2.2 ■ 25 G	P2.3 ■ 22 E	P3.1 ■ 19 F	P3.2 ■ 15 F	P3.3 ■ 13 E	P4.1 ■ 11 F	P4.2 ■ 10 E	P4.3 ■ 8 D	M1.1 ■ 21 E	M1.2 ■ 17 E
M2.1 ■ 18 E	M2.2 ■ 15 E	M3.1 ■ 9 G	M3.2 ■ 8 G	M3.3 ■ 7 G	M4.1 ■ 10 C	K1.1 ■ 30 I	K1.2 ■ 22 F	K1.3 ■ 17 F	K2.1 ■ 25 E	K2.2 ■ 20 E	K2.3 ■ 16 E	K3.1 ■ 22 E	K3.2 ■ 17 E
K3.3 ■ 13 E	K4.1 ■ 20 E	K4.2 ■ 15 E	K4.3 ■ 11 E	K4.4 ■ 10 E	K4.5 ■ 8 E	K5.1 ■ 23 E	K5.2 ■ 17 E	K5.3 ■ 13 E	N1.1 ■ 33 J	N1.2 ■ 25 J	N1.3 ■ 17 I	N2.1 ■ 42 H	N2.2 ■ 37 H
N2.3 ■ 27 H	N3.1 ■ 56 H	N3.2 ■ 33 I	N3.3 ■ 17 G	N4.1 ■ 30 J	N4.2 ■ 28 H	N4.3 ■ 14 F	S1.1 ■ 24 F	S1.2 ■ 13 D	S1.3 ■ 7 B	S2.1 ■ 7 E	S2.2 ■ 6 A	S3.1 ■ 5 E	S3.2 ■ 4 A
S4.1 ■ 4 E	S4.2 ■ 3 A												

Los productos de esta serie también están disponibles en forma de Set. Por favor, vea A296.

Producto	Nr.	DC (inch)	DC (inch)	SDL_1 (inch)	OAL (inch)	DCONMS (inch)
A225BS1	BS1	3/64	0.0469	5/64 - 1/16	1.1/2	1/8
A225BS2	BS2	1/16	0.0625	3/32 - 5/64	1.3/4	3/16
A225BS3	BS3	3/32	0.0938	5/32 - 1/8	2"	1/4
A225BS4	BS4	1/8	0.1250	3/16 - 5/32	2.1/4	5/16
A225BS5	BS5	3/16	0.1875	9/32 - 1/4	2.1/2	7/16
A225BS5A	BSSA	7/32	0.2188	5/16 - 9/32	2.3/4	1/2
A225BS6	BS6	1/4	0.2500	3/8 - 5/16	3"	5/8
A225BS7	BS7	5/16	0.3125	15/32 - 13/32	3.1/2	3/4



A237

DORMER



Broca de Centrar HSS-E (5% Cobalto), Chaflán a 60°, Punta a 118°, Acabado Brillante

Diseñada para iniciar un agujero preciso en el extremo de un eje para poder sujetarlo de forma segura antes del mecanizado. Las puntas a ambos lados aumentan la productividad por herramienta. Acabado brillante. Adecuada para taladrar la mayoría de materiales.

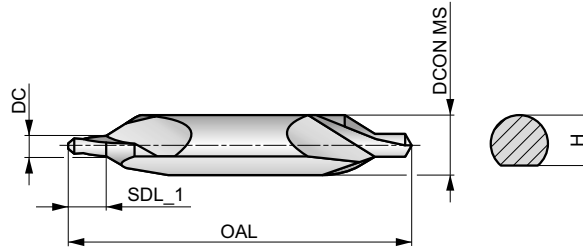

HSS-E	DIN 333A	1xD
60°	Bright	H
R	118°	

Grupo de Material de la pieza adecuado y condiciones de velocidad de corte iniciales (m/min) y código de avance alfabético. Tablas con avance por revolución a partir de la pag.175.

P1.1 ■ 33 I	P1.2 ■ 37 I	P1.3 ■ 38 I	P2.1 ■ 28 I	P2.2 ■ 25 G	P2.3 ■ 22 E	P3.1 ■ 19 F	P3.2 ■ 15 F	P3.3 ■ 13 E	P4.1 ■ 11 F	P4.2 ■ 10 E	P4.3 ■ 8 D	M1.1 ■ 21 E	M1.2 ■ 17 E
M2.1 ■ 18 E	M2.2 ■ 15 E	M3.1 ■ 9 G	M3.2 ■ 8 G	M3.3 ■ 7 G	M4.1 ■ 10 C	K1.1 ■ 30 I	K1.2 ■ 22 F	K1.3 ■ 17 F	K2.1 ■ 25 E	K2.2 ■ 20 E	K2.3 ■ 16 E	K3.1 ■ 22 E	K3.2 ■ 17 E
K3.3 ■ 13 E	K4.1 ■ 20 E	K4.2 ■ 15 E	K4.3 ■ 11 E	K4.4 ■ 10 E	K4.5 ■ 8 E	K5.1 ■ 23 E	K5.2 ■ 17 E	K5.3 ■ 13 E	N1.1 ■ 33 J	N1.2 ■ 25 J	N1.3 ■ 17 I	N2.1 ■ 42 H	N2.2 ■ 37 H
N2.3 ■ 27 H	N3.1 ■ 56 H	N3.2 ■ 33 I	N3.3 ■ 17 G	N4.1 ■ 30 J	N4.2 ■ 28 H	N4.3 ■ 14 F	S1.1 ■ 24 F	S1.2 ■ 13 D	S1.3 ■ 7 B	S2.1 ■ 7 E	S2.2 ■ 6 A	S3.1 ■ 5 E	S3.2 ■ 4 A
S4.1 ■ 4 E	S4.2 ■ 3 A												

Producto	DC	DC	SDL_1	OAL	D CON MS	H
	(mm)	(inch)	(mm)	(mm)	(mm)	(mm)
A2371.6X4.0	1.60	0.0630	2.6 - 2.0	35.0	4.00	3.25 - 3.15
A2372.0X5.0	2.00	0.0787	3.1 - 2.5	40.0	5.00	4.20 - 4.10
A2372.5X6.3	2.50	0.0984	3.8 - 3.1	45.0	6.30	5.35 - 5.25
A2373.15X8.0	3.15	0.1240	4.6 - 3.9	50.0	8.00	6.95 - 6.85
A2374.0X10.0	4.00	0.1575	5.9 - 5.0	55.0	10.00	8.40 - 8.30
A2375.0X12.5	5.00	0.1969	7.2 - 6.3	63.0	12.50	10.95 - 10.85
A2376.3X16.0	6.30	0.2480	8.9 - 8.0	71.0	16.00	14.00 - 13.90
A2378.0X20.0	8.00	0.3150	11.1 - 10.1	80.0	20.00	17.90 - 17.80
A23710.0X25.0	10.00	0.3937	13.8 - 12.8	100.0	25.00	22.50 - 22.40



A238



Broca de Centrar HSS-E (5% Cobalto), Chaflán Cónico, Punta a 118°, Acabado Brillante

Diseñada para iniciar un agujero preciso en el extremo de un eje para poder sujetarlo de forma segura antes del mecanizado. Las puntas a ambos lados aumentan la productividad por herramienta. Adecuada para taladrar la mayoría de materiales. Acabado brillante. Se puede utilizar con adaptadores especiales de achaflanado.

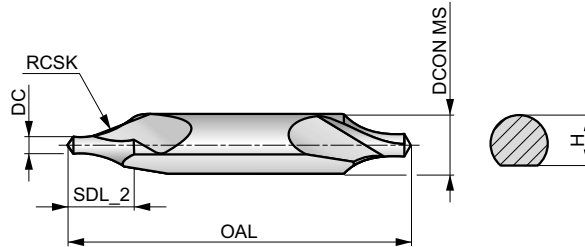

HSS-E	DIN 333R	1xD
R	Bright	H
R	118°	

Grupo de Material de la pieza adecuada y condiciones de velocidad de corte iniciales (m/min) y código de avance alfabético. Tablas con avance por revolución a partir de la pag.175.

P1.1 ■ 33 I	P1.2 ■ 37 I	P1.3 ■ 38 I	P2.1 ■ 28 I	P2.2 ■ 25 G	P2.3 ■ 22 E	P3.1 ■ 19 F	P3.2 ■ 15 F	P3.3 ■ 13 E	P4.1 ■ 11 F	P4.2 ■ 10 E	P4.3 ■ 8 D	M1.1 ■ 21 E	M1.2 ■ 17 E
M2.1 ■ 18 E	M2.2 ■ 15 E	M3.1 ■ 9 G	M3.2 ■ 8 G	M3.3 ■ 7 G	M4.1 ■ 10 C	K1.1 ■ 30 I	K1.2 ■ 22 F	K1.3 ■ 17 F	K2.1 ■ 25 E	K2.2 ■ 20 E	K2.3 ■ 16 E	K3.1 ■ 22 E	K3.2 ■ 17 E
K3.3 ■ 13 E	K4.1 ■ 20 E	K4.2 ■ 15 E	K4.3 ■ 11 E	K4.4 ■ 10 E	K4.5 ■ 8 E	K5.1 ■ 23 E	K5.2 ■ 17 E	K5.3 ■ 13 E	N1.1 ■ 33 J	N1.2 ■ 25 J	N1.3 ■ 17 I	N2.1 ■ 42 H	N2.2 ■ 37 H
N2.3 ■ 27 H	N3.1 ■ 56 H	N3.2 ■ 33 I	N3.3 ■ 17 G	N4.1 ■ 30 J	N4.2 ■ 28 H	N4.3 ■ 14 F	S1.1 ■ 24 F	S1.2 ■ 13 D	S1.3 ■ 7 B	S2.1 ■ 7 E	S2.2 ■ 6 A	S3.1 ■ 5 E	S3.2 ■ 4 A
S4.1 ■ 4 E	S4.2 ■ 3 A												

Producto	DC	DC	SDL_2	OAL	RCSK	DCON MS	H
	(mm)	(inch)	(mm)	(mm)	(mm)	(mm)	(mm)
A2381.6X4.0	1.60	0.0630	4.7 - 4.2	35.0	5.00 - 4.00	4.00	3.25 - 3.15
A2382.0X5.0	2.00	0.0787	5.4 - 5.0	40.0	6.25 - 5.00	5.00	4.20 - 4.10
A2382.5X6.3	2.50	0.0984	6.8 - 6.3	45.0	7.88 - 6.30	6.30	5.35 - 5.25
A2383.15X8.0	3.15	0.1240	8.5 - 8.0	50.0	10.00 - 8.00	8.00	6.95 - 6.85
A2384.0X10.0	4.00	0.1575	10.6 - 10.0	55.0	12.50 - 10.00	10.00	8.40 - 8.30
A2385.0X12.5	5.00	0.1969	13.1 - 12.5	63.0	15.63 - 12.50	12.50	10.95 - 10.85
A2386.3X16.0	6.30	0.2480	16.6 - 16.0	71.0	20.00 - 16.00	16.00	14.00 - 13.90
A2388.0X20.0	8.00	0.3150	20.7 - 20.0	80.0	25.00 - 20.00	20.00	17.90 - 17.80



A242



Broca de Centrar Larga HSS-E (5% Cobalto), Chafilán a 60°, Punta a 118°, Acabado Brillante

Diseñada para iniciar un agujero preciso en el extremo de un eje para poder sujetarlo de forma segura antes del mecanizado. Las puntas a ambos lados aumentan la productividad por herramienta. Adecuada para taladrar la mayoría de materiales.

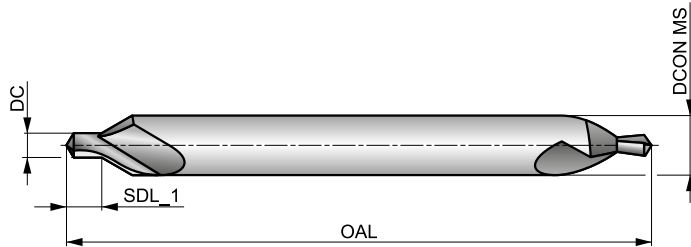

HSS-E	DORMER	1xD
60°	Bright	
R	118°	

Grupo de Material de la pieza adecuado y condiciones de velocidad de corte iniciales (m/min) y código de avance alfabético. Tablas con avance por revolución a partir de la pag.175.

P1.1 ■ 33 I	P1.2 ■ 37 I	P1.3 ■ 38 I	P2.1 ■ 28 I	P2.2 ■ 25 G	P2.3 ■ 22 E	P3.1 ■ 19 F	P3.2 ■ 15 F	P3.3 ■ 13 E	P4.1 ■ 11 F	P4.2 ■ 10 E	P4.3 ■ 8 D	M1.1 ■ 21 E	M1.2 ■ 17 E
M2.1 ■ 18 E	M2.2 ■ 15 E	M3.1 ■ 9 G	M3.2 ■ 8 G	M3.3 ■ 7 G	M4.1 ■ 10 C	K1.1 ■ 30 I	K1.2 ■ 22 F	K1.3 ■ 17 F	K2.1 ■ 25 E	K2.2 ■ 20 E	K2.3 ■ 16 E	K3.1 ■ 22 E	K3.2 ■ 17 E
K3.3 ■ 13 E	K4.1 ■ 20 E	K4.2 ■ 15 E	K4.3 ■ 11 E	K4.4 ■ 10 E	K4.5 ■ 8 E	K5.1 ■ 23 E	K5.2 ■ 17 E	K5.3 ■ 13 E	N1.1 ■ 33 J	N1.2 ■ 25 J	N1.3 ■ 17 I	N2.1 ■ 42 H	N2.2 ■ 37 H
N2.3 ■ 27 H	N3.1 ■ 56 H	N3.2 ■ 33 I	N3.3 ■ 17 G	N4.1 ■ 30 J	N4.2 ■ 28 H	N4.3 ■ 14 F	S1.1 ■ 24 F	S1.2 ■ 13 D	S1.3 ■ 7 B	S2.1 ■ 7 E	S2.2 ■ 6 A	S3.1 ■ 5 E	S3.2 ■ 4 A
S4.1 ■ 4 E	S4.2 ■ 3 A												

Producto	DC	DC	SDL_1	OAL	DCON MS
	(mm)	(inch)	(mm)	(mm)	(mm)
A2421.0X4.0	1.00	0.0394	1.7 - 1.3	100.0	4.00
A2421.5X5.0	1.50	0.0591	2.6 - 2.0	100.0	5.00
A2422.0X6.0	2.00	0.0787	3.1 - 2.5	100.0	6.00
A2422.5X8.0	2.50	0.0984	3.8 - 3.1	100.0	8.00
A2423.0X8.0	3.00	0.1181	4.6 - 3.9	100.0	8.00
A2423.0X10.0	3.00	0.1181	4.6 - 3.9	100.0	10.00
A2424.0X10.0	4.00	0.1575	5.9 - 5.0	100.0	10.00
A2424.0X12.0	4.00	0.1575	5.9 - 5.0	100.0	12.00
A2425.0X12.0	5.00	0.1969	7.2 - 6.3	100.0	12.00



A088

DORMER



Juego de Brocas A022 HSS, Serie Extra Corta, con la Punta Recubierta TiN

Un juego que contiene 24 diámetros diferentes de la broca A022 en un resistente estuche, con una amplia gama de tamaños cubiertos en una sola compra. Las brocas son adecuadas para su uso tanto en máquinas como en taladros manuales en muchas aplicaciones. El recubrimiento TiN-Tip mejora el rendimiento y prolonga la vida útil de la herramienta.

HSS	DIN ANSI	2.5×D
135°		
20-35°		DC h8

A=Tipos en el Juego, B=No en el Juego, C=Diámetros en el Juego.

Producto	Nr.	A	B	C
A0882005	2005	A022	24	1.0 mm - 10.5 mm x 0.5 mm + 3.3 mm, 4.2 mm, 6.8 mm, 10.2 mm

A095

DORMER



Juego de Brocas HSS Serie Corta, con Brocas A002, Recubrimiento TiN en la Punta

Diferentes juegos de nuestras brocas A002 en tamaños métricos o fraccionales, en un útil estuche de plástico. El juego mantiene todas las brocas juntas, con tamaños que se muestran claramente para una fácil selección. Las brocas son adecuadas para su uso tanto en máquinas como en aplicaciones manuales. El recubrimiento TiN-Tip mejora el rendimiento y prolonga la vida útil de la herramienta.

HSS	DIN 338	4×D
118°		
20-35°		DC h8

1.0mm =< DC >= 2.9mm Punta de 4 caras a 118°. A=Tipos en el Juego, B=No en el Juego, C=Diámetros en el Juego.

Producto	Nr.	A	B	C
A09518	18	A002	29	1/16 inch - 1/2 inch x 1/64 inch
A09520	20	A002	15	1/16 inch - 1/2 inch x 1/32 inch
A095200	200	A002	24	1.0 mm - 10.5 mm x 0.5 mm + 3.3 mm, 4.2 mm, 6.8 mm, 10.2 mm
A095201	201	A002	19	1.0 mm - 10.0 mm x 0.5 mm
A095202	202	A002	51	1.0 mm - 6.0 mm x 0.1 mm
A095203	203	A002	41	6.0 mm - 10.0 mm x 0.1 mm
A095204	204	A002	25	1.0 mm - 13.0 mm x 0.5 mm
A095206	206	A002	29	1.0 mm - 13.0 mm x 0.5 mm + 3.3 mm, 4.2 mm, 6.8 mm, 10.2 mm
A095209	209	A002	91	1.0 mm - 10.0 mm x 0.1 mm



A087

DORMER



Juego de Brocas A002 HSS Serie Corta, con la Punta Recubierta TiN

Un juego que contiene 19 diámetros diferentes de la popular broca A002 en un estuche compacto fácil de transportar, con tamaños que se muestran claramente para una fácil selección. Las brocas son adecuadas para su uso tanto en máquinas como en taladros manuales, y en muchas aplicaciones. El recubrimiento TiN-Tip mejora el rendimiento y prolonga la vida útil de la herramienta.

HSS	DIN 338	4xD
118°	TiN-Tip	
λ 20-35°	R	DC h8

A=Tipos del Juego, B=No del Juego, C=Diámetros en el Juego 1.0mm =< DC >= 2.9mm Punta de 4 caras a 118°

Producto	Nr.	A	B	C
A087201	201	A002	19	1.0 mm - 10.0 mm x 0.5 mm

A094

DORMER



Juego de Brocas A002 HSS, Serie Corta, con la Punta Recubierta TiN

Un juego que contiene brocas A002 de diferentes diámetros métricos en un dispensador giratorio inteligentemente diseñado que hace que la selección del tamaño requerido sea muy simple. Gire la tapa de plástico transparente hasta que el agujero de la carcasa resalte el tamaño requerido y dé la vuelta al juego para sacar la broca.

HSS	DIN 338	4xD
118°	TiN-Tip	
λ 20-35°	R	DC h8

A=Tipos del Juego, B=No del Juego, C=Diámetros en el Juego 1.0mm =< DC >= 2.9mm Punta de 4 caras a 118°

Producto	Nr.	A	B	C
A094413	413	A002	13	1.5 mm - 6.5 mm x 0.5 mm + 3.3 mm, 4.2 mm
A094419	419	A002	19	1.0 mm - 10.0 mm x 0.5 mm



A089



Juego de Brocas A002 HSS, Serie Corta, con la Punta Recubierta TiN

Un juego que contiene 5 diámetros diferentes de la popular broca A002 en un práctico estuche, cubriendo varios diámetros con una sola compra. Las brocas son adecuadas para su uso tanto en máquinas como en taladros manuales en muchas aplicaciones. El recubrimiento TiN-Tip mejora el rendimiento y prolonga la vida útil de la herramienta.

A=Tipos en el Juego, B=No en el Juego, C=Diámetros en el Juego.

Producto	Nr.	A	B	C
A08910	10	A002	5	A0024.0, A0025.0, A0026.0, A0028.0, A00210.0



A099



Expositor de Mostrador con Brocas A002 HSS Serie Corta, con la Punta Recubierta TiN

Dispensador de mostrador que contiene una amplia gama de tamaños de brocas A002. Diseñado para colocarse sobre un mostrador u otra superficie plana adecuada para una exhibición prominente y donde las brocas se pueden extraer fácilmente cuando sea necesario. Fácil de rellenar con más brocas A002, ofrecerá años de servicio.

HSS	DIN 338	4xD
118°	TiN-Tip	
λ 20-35°	R	DC h8

1.0mm =< DC >= 2.9mm Punta de 4 caras a 118°. A=Tipos en el Juego, B=No en el Juego, C=Diámetros en el Juego.

Producto	Nr.	A	B	C
A099F1	F1	A002	380	5 x (13/32, 7/16, 15/32, 1/2) inch; 10 x (5/64, 7/64, 9/64, 11/64, 13/64, 15/64, 17/64, 9/32, 19/64, 5/16, 21/64, 11/32, 23/64, 3/8) inch; 20 x (1/16, 7/32, 1/4) inch; 30 x 3/32 inch; 40 x (5/32, 3/16) inch; 50 x 1/8 inch
A099M1	M1	A002	340	5 x (10.50, 11.00, 11.50, 12.00, 12.50, 13.00) mm; 10 x (1.50, 2.50, 3.50, 4.50, 5.50, 6.50, 7.00, 7.50, 8.00, 8.50, 9.00, 9.50, 10.00) mm; 20 x (1.00, 5.00, 6.00) mm; 30 x 2.00 mm; 40 x 4.00 mm; 50 x 3.00 mm

A099



Expositor de Mostrador con Brocas A002 HSS Serie Corta, con la Punta Recubierta TiN

Dispensador de mostrador que contiene una amplia gama de tamaños de brocas A002. Diseñado para colocarse sobre un mostrador u otra superficie plana adecuada para una exhibición prominente y donde las brocas se pueden extraer fácilmente cuando sea necesario. Fácil de rellenar con más brocas A002, ofrecerá años de servicio.

HSS	DIN 338	4xD
118°	TiN-Tip	
λ 20-35°	R	DC h8

1.0mm =< DC >= 2.9mm Punta de 4 caras a 118°. A=Tipos en el Juego, B=No en el Juego, C=Diámetros en el Juego.

Producto	Nr.	A	B	C
A099DRILLBOY	DRILLBOY	A002	43	3 x (3.0 mm, 3.3 mm, 3.5 mm, 4.0 mm) + 2 x (4.2 mm, 4.5 mm, 5.0 mm, 5.5 mm, 6.0 mm, 6.5 mm, 6.8 mm, 7.0 mm, 7.5 mm, 8.0 mm) + 8.5 mm, 9.0 mm, 9.5 mm, 10.0 mm, 10.2 mm, 10.5 mm, 11.0 mm, 11.5 mm, 12.0 mm, 12.5 mm, 13.0 mm



A199

DORMER



Expositor de Mostrador con Brocas A100 HSS Serie Corta

Dispensador de mostrador que contiene una amplia gama de tamaños de brocas A100. Diseñado para colocarse sobre un mostrador u otra superficie plana adecuada para una exhibición prominente y donde las brocas se pueden extraer fácilmente cuando sea necesario. Fácil de rellenar con más brocas A100, ofrecerá años de servicio.

HSS	DIN 338	4xD
118°	ST	
20-35°	R	DC h8

A=Tipos en el Juego, B=No en el Juego, C=Diámetros en el Juego.

Producto	Nr.	A	B	C
A199F1	F1	A100	380	5 x (13/32, 7/16, 15/32, 1/2) inch; 10 x (5/64, 7/64, 9/64, 11/64, 13/64, 15/64, 17/64, 9/32, 19/64, 5/16, 21/64, 11/32, 23/64, 3/8) inch; 20 x (1/16, 7/32, 1/4) inch; 30 x 3/32 inch; 40 x (5/32, 3/16) inch; 50 x 1/8 inch
A199M1	M1	A100	340	5 x (10.50, 11.00, 11.50, 12.00, 12.50, 13.00) mm; 10 x (1.50, 2.50, 3.50, 4.50, 5.50, 6.50, 7.00, 7.50, 8.00, 8.50, 9.00, 9.50, 10.00) mm; 20 x (1.00, 5.00, 6.00) mm; 30 x 2.00 mm; 40 x 4.00 mm; 50 x 3.00mm

A080

DORMER



Expositor de Mostrador Vacío para Brocas

El dispensador se suministra vacío por lo que las brocas se pueden comprar por separado, eligiendo cantidades que se adapten a las ventas en mostrador. Viene en plástico rojo, marcado con el logo de Dormer y una imagen de varias brocas Dormer. Los diámetros de broca métricos o fraccionales están marcados en los tres estantes.

Dispensador Vacío

Producto	Nr.	C
A080M1EMPTY	M1EMPTY	(1.00, 1.50, 2.00, 2.50, 3.00, 3.50, 4.00, 4.50, 5.00, 5.50, 6.00, 6.50, 7.00, 7.50, 8.00, 8.50, 9.00, 9.50, 10.00, 10.50, 11.00, 11.50, 12.00) mm
A080F1EMPTY	F1EMPTY	(1/16, 5/64, 3/32, 7/64, 1/8, 9/64, 5/32, 11/64, 3/16, 13/64, 7/32, 15/64, 1/4, 17/64, 9/32, 19/64, 5/16, 21/64, 11/32, 3/8, 13/32, 7/16, 1/2) inch



A190

DORMER



Juego de Brocas HSS Serie Corta, con Brocas A100, Acabado Templado al Vapor

Juego de brocas A100 con punta convencional a 118°. Se suministra en juegos de tamaño métrico o fraccional en una práctica caja de plástico que hace que la selección del tamaño de broca requerido sea muy simple.

HSS	DIN 338	4xD
118°		
λ 20-35°		DC h8

A=Tipos del Juego, B=No del Juego, C=Diámetros en el Juego DC <= 1mm; 3/64"; N60 Brillante

Producto	Nr.	A	B	C
A1903	3	A100	21	1/16 inch - 3/8 inch x 1/64 inch
A19012	12	A100	60	No.1 - No.60
A19018	18	A100	29	1/16 inch - 1/2 inch x 1/64 inch
A19020	20	A100	15	1/16 inch - 1/2 inch x 1/32 inch
A190201	201	A100	19	1.0 mm - 10.0 mm x 0.5 mm
A190202	202	A100	51	1.0 mm - 6.0 mm x 0.1 mm
A190203	203	A100	41	6.0 mm - 10.0 mm x 0.1 mm
A190204	204	A100	25	1.0 mm - 13.0 mm x 0.5 mm
A190206	206	A100	29	1.0 mm - 13.0 mm x 0.5 mm + 3.3 mm, 4.2 mm, 6.8 mm, 10.2 mm
A190209 ¹⁾	209	A100	91	1.0 mm - 10.0 mm x 0.1 mm

¹⁾ Se vende en cajas de 2. Caja 1 contiene las medidas (1.0-5.9 x 0.1mm); Caja 2 contiene las medidas (6.0-10.0 x 0.1mm).



A191

DORMER

Juego de Brocas A100 HSS, Serie Corta, Acabado Templado al Vapor

Un juego que contiene brocas A100 de diferentes diámetros métricos en un estuche compacto fácil de transportar, con tamaños que se muestran claramente para una fácil selección. Brocas A100 con punta convencional a 118°. Se suministra en juegos de tamaños métricos o de cable, en una práctica caja de plástico que facilita la selección del tamaño de broca requerido.



HSS	DIN 338	4xD
118°	ST	
20-35°		DC h8

A=Tipos del Juego, B=No del Juego, C=Diámetros en el Juego DC <= 1mm; 3/64"; N60 Brillante

Producto	Nr.	A	B	C
A19131M	31M	A100	20	0.3 mm - 1.0 mm x 0.05 mm + 0.38 mm, 0.52 mm, 0.58 mm, 0.78 mm, 0.82 mm
A19161-80	61-80	A100	20	No.61 - No. 80

A191

DORMER

Juego de Brocas A100 HSS, Serie Corta, Acabado Templado al Vapor

Un juego que contiene brocas A100 de diferentes diámetros métricos en un dispensador giratorio inteligentemente diseñado que hace que la selección del tamaño requerido sea muy simple. Gire la tapa de plástico transparente hasta que el agujero de la carcasa resalte el tamaño requerido y dé la vuelta al juego para sacar la broca.



HSS	DIN 338	4xD
118°	ST	
20-35°		DC h8

A=Tipos del Juego, B=No del Juego, C=Diámetros en el Juego DC <= 1mm; 3/64"; N60 Brillante

Producto	Nr.	A	B	C
A191413	413	A100	13	1.5 mm - 6.5 mm x 0.5 mm + 3.3 mm, 4.2 mm
A191419	419	A100	19	1.0 mm - 10.0 mm x 0.5 mm



A188

DORMER



Juego de Brocas A108 HSS, Serie Corta, Acabado Templado al Vapor

Un juego con diferentes tamaños fraccionales de nuestras brocas A108 en un útil estuche de plástico. Se pueden utilizar en diferentes aplicaciones con máquinas y taladros manuales.

HSS	DIN 338	4xD
135°	ST	
λ > 35°	R	DC h8

A=Tipos del Juego, B=No del Juego, C=Diámetros en el Juego DC > 1.5mm; 1/16" Punta afilada en cruz

Producto	Nr.	A	B	C
A188201	201	A108	19	1.0 mm - 10.0 mm x 0.5 mm
A188204	204	A108	25	1.0 mm - 13.0 mm x 0.5 mm

A295

DORMER



Juego de Brocas A777 HSS-E (8% Cobalto), Serie Corta, con Acabado Bronce

Un juego con diferentes tamaños fraccionales de nuestras brocas A777 en un útil estuche de plástico. El juego mantiene todas las brocas juntas y ordenadas, con tamaños que se muestran claramente para una fácil selección. Las brocas A777 están diseñadas con punta dividida a 135° para facilitar el autocentrado y reducir las fuerzas de corte.

HSS-E	DIN 338	4xD
135°	Bronze	
λ 20-35°	R	DC h8

A=Tipos en el Juego, B=No en el Juego, C=Diámetros en el Juego. DC ≤ 1.4mm Punta de 4 caras

Producto	Nr.	A	B	C
A295219	219	A777	19	1.0 mm - 10.0 mm x 0.5 mm
A295225	225	A777	25	1.0 mm - 13.0 mm x 0.5 mm



A296

DORMER

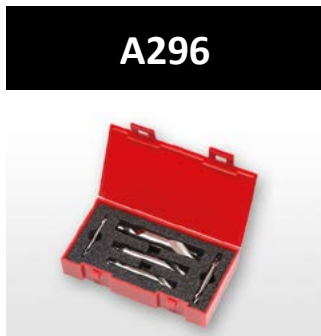

Juego de Brocas de Centrar HSS

Un juego de cinco brocas de centrar que vienen en un práctico estuche de plástico para mantener todas las brocas juntas. Recomendadas para iniciar un agujero preciso en el extremo de un eje para poder sujetarlo de forma segura antes del mecanizado. Las puntas a ambos lados aumentan la productividad por herramienta.

A296200 - punta de 118° DIN333A, A296225 - punta de 120° BS328. A=Tipos en el Juego, B=No en el Juego, C=Dímetros en el Juego.

Producto	Nr.	A	B	C
A296200	200	A200	5	1.00 mm, 2.00 mm, 2.50 mm, 3.15 mm, 4.00 mm
A296225	225	A225	5	BS1, BS2, BS3, BS4, BS5

M150

DORMER



Cono de Reducción, Templado en Aceite

Adaptador utilizado para montar brocas con mango cónico pequeño en máquinas con husillos cónicos más grandes.

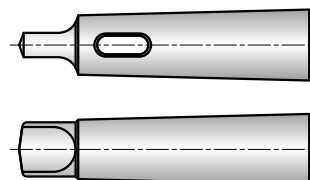

K= Cono Morse Externo; K1=Cono Morse Interno

Producto	Nr.	K = Nr.	K1 = Nr.
M1501-0	10	Nr. 1	Nr. 0
M1502-1	21	Nr. 2	Nr. 1
M1503-1	31	Nr. 3	Nr. 1
M1504-1	41	Nr. 4	Nr. 1
M1503-2	32	Nr. 3	Nr. 2
M1504-2	42	Nr. 4	Nr. 2
M1505-2	52	Nr. 5	Nr. 2
M1504-3	43	Nr. 4	Nr. 3
M1505-3	53	Nr. 5	Nr. 3
M1505-4	54	Nr. 5	Nr. 4
M1506-5	65	Nr. 6	Nr. 5



M151

DORMER



Cono de Reducción Templado y Rectificado

Adaptador utilizado para montar brocas con mango cónico pequeño en máquinas con husillos cónicos más grandes.

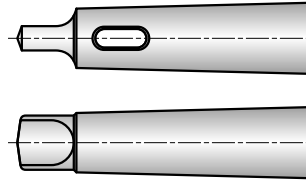

K= Cono Morse Externo; K1=Cono Morse Interno

Producto	Nr.	K = Nr.	K1 = Nr.
M1511-0	10	Nr. 1	Nr. 0
M1512-1	21	Nr. 2	Nr. 1
M1513-1	31	Nr. 3	Nr. 1
M1514-1	41	Nr. 4	Nr. 1
M1513-2	32	Nr. 3	Nr. 2
M1514-2	42	Nr. 4	Nr. 2
M1515-2	52	Nr. 5	Nr. 2
M1514-3	43	Nr. 4	Nr. 3
M1515-3	53	Nr. 5	Nr. 3
M1515-4	54	Nr. 5	Nr. 4
M1516-5	65	Nr. 6	Nr. 5

M152

DORMER



Expulsor de Broca

Se utiliza para expulsar brocas de mango cónico de los husillos de máquina y manguitos cónicos Morse.



Producto	Nr.
M1520	Nr. 0
M15212	Nr. 1 + 2
M15234	Nr. 3 + 4
M15245	Nr. 4 + 5
M1526	Nr. 6



TABLA DE VELOCIDADES DE AVANCE DE TALADRADO

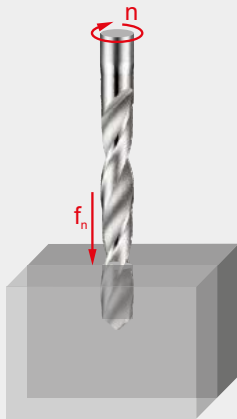

Avance por revolución (f_n en mm/rev)
 Dependiendo de las condiciones de
 trabajo puede ser necesario ajustar estos
 valores $\pm 25\%$

Cómo utilizar esta tabla para encontrar el valor de avance por revolución (f_n):

1. Localice su código alfa en la página del producto (ejemplo: 46J, «J» es el código alfa).
2. Localice en la fila superior de la tabla el diámetro más adecuado para su aplicación de corte.
3. Localice su código alfa en la columna de la izquierda de la tabla.
4. La intersección (celda) del diámetro y el código alfa es el avance por revolución (f_n).

		ø DC (mm)																		
		0.15	0.50	1.00	2.00	3.00	4.00	5.00	6.00	8.00	10.00	12.00	15.00	16.00	20.00	25.00	30.00	40.00	50.00	100.00
Avances	A	0.003	0.006	0.012	0.023	0.029	0.032	0.036	0.042	0.054	0.062	0.069	0.082	0.086	0.110	0.125	0.135	0.155	0.175	0.263
	B	0.004	0.007	0.014	0.028	0.037	0.041	0.046	0.053	0.067	0.080	0.090	0.103	0.108	0.135	0.153	0.165	0.188	0.208	0.312
	C	0.004	0.008	0.015	0.032	0.044	0.050	0.056	0.064	0.080	0.098	0.110	0.125	0.130	0.160	0.180	0.195	0.220	0.240	0.360
	D	0.004	0.008	0.016	0.038	0.053	0.060	0.068	0.078	0.098	0.119	0.130	0.149	0.155	0.188	0.210	0.228	0.253	0.275	0.413
	E	0.004	0.009	0.017	0.043	0.062	0.071	0.080	0.092	0.115	0.140	0.150	0.173	0.180	0.215	0.240	0.260	0.285	0.310	0.465
	F	0.005	0.009	0.018	0.050	0.073	0.084	0.095	0.109	0.138	0.165	0.178	0.202	0.210	0.248	0.275	0.295	0.320	0.343	0.515
	G	0.005	0.010	0.019	0.056	0.084	0.096	0.109	0.126	0.160	0.190	0.205	0.231	0.240	0.280	0.310	0.330	0.355	0.375	0.563
	H	0.005	0.010	0.020	0.066	0.102	0.116	0.130	0.150	0.190	0.228	0.243	0.271	0.280	0.320	0.355	0.375	0.398	0.418	0.627
	I	0.005	0.011	0.021	0.076	0.119	0.134	0.150	0.173	0.220	0.265	0.280	0.310	0.320	0.360	0.400	0.420	0.440	0.460	0.690
	J	0.006	0.012	0.024	0.084	0.135	0.152	0.170	0.197	0.250	0.298	0.315	0.349	0.360	0.405	0.445	0.465	0.485	0.503	0.755
	K	0.007	0.013	0.026	0.092	0.150	0.170	0.190	0.220	0.280	0.330	0.350	0.388	0.400	0.450	0.490	0.510	0.530	0.545	0.818
	L	0.007	0.014	0.028	0.101	0.165	0.186	0.208	0.240	0.305	0.360	0.385	0.419	0.430	0.485	0.525	0.545	0.568	0.588	0.882
	M	0.008	0.015	0.030	0.110	0.180	0.202	0.225	0.260	0.330	0.390	0.420	0.450	0.460	0.520	0.560	0.580	0.605	0.630	0.945
	N	0.008	0.016	0.032	0.119	0.195	0.218	0.242	0.280	0.355	0.420	0.455	0.481	0.490	0.555	0.595	0.615	0.642	0.672	1.008
	S	0.002	0.004	0.008	0.014	0.020	0.025	0.030	0.037	0.050	0.080	0.100	0.123	0.130	0.150	0.170	0.190	0.220	0.240	–
	T	0.004	0.008	0.015	0.028	0.040	0.050	0.060	0.070	0.090	0.110	0.130	0.160	0.170	0.190	0.210	0.230	0.260	0.275	–
	U	0.007	0.013	0.026	0.048	0.070	0.080	0.090	0.107	0.140	0.170	0.200	0.223	0.230	0.240	0.270	0.300	0.360	0.375	–
	V	0.010	0.019	0.038	0.069	0.100	0.115	0.130	0.153	0.200	0.250	0.280	0.310	0.320	0.340	0.400	0.440	0.510	0.530	–
	W	0.012	0.025	0.049	0.089	0.130	0.150	0.170	0.200	0.260	0.330	0.380	0.418	0.430	0.450	0.470	0.490	0.520	0.540	–
	X	0.014	0.028	0.056	0.103	0.150	0.180	0.210	0.250	0.330	0.420	0.480	0.533	0.550	0.580	–	–	–	–	–
Y	0.017	0.034	0.068	0.124	0.180	0.220	0.260	0.317	0.430	0.550	0.700	0.700	0.700	0.740	–	–	–	–	–	
Z	0.024	0.047	0.094	0.172	0.250	0.325	0.400	0.533	0.800	1.000	1.100	1.175	1.200	1.200	–	–	–	–	–	



TALADRADO
INFORMACIÓN TÉCNICA



BROCAS DE METAL DURO Y HSS: INFORMACIÓN TÉCNICA

Nomenclatura de la broca

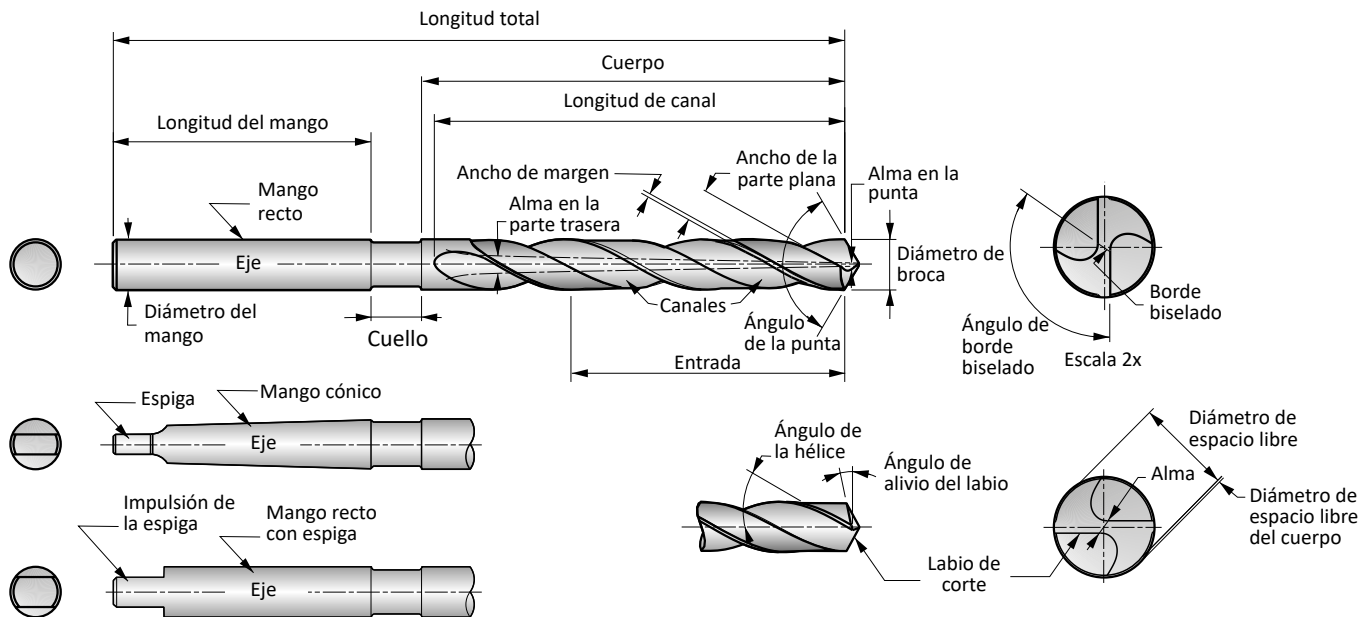

- **Eje:** línea recta imaginaria que forma la línea central longitudinal de una broca.
- **Chaflán de salida:** una ligera disminución del diámetro desde la parte delantera a la trasera en el cuerpo de una broca.
- **Cuerpo:** la parte de una broca que va desde el mango o cuello hasta las esquinas exteriores de los labios de corte.
- **Diámetro de espacio libre del cuerpo:** parte de la parte plana que se ha cortado para que no se adhiera a las paredes del agujero.
- **Borde biselado:** borde al final del alma que conecta los labios de corte.
- **Ángulo del borde biselado:** el ángulo entre el borde biselado y el labio de corte, visto desde el extremo de una broca.
- **Diámetro de espacio libre:** el diámetro sobre la parte cortada de las partes planas de la broca.
- **Broca:** herramienta de corte de extremo giratorio que tiene uno o más labios de corte, y que cuenta con uno o más canales helicoidales o rectos para el paso de las virutas y la entrada de un fluido de corte.
- **Diámetro de broca:** diámetro sobre los márgenes de una broca medido en la punta.
- **Longitud de canal:** longitud desde las esquinas exteriores de los labios de corte hasta el extremo posterior de los canales. Incluye el barrido de la herramienta utilizada para generar los canales y, por lo tanto, no indica la longitud útil de los canales.
- **Canales:** ranuras rectas o helicoidales cortadas o formadas en el cuerpo de una broca para obtener labios de corte, permitir la eliminación de virutas y facilitar el acceso del fluido de corte a los labios de corte.
- **Ángulo de la hélice:** ángulo formado por el borde de entrada de la parte plana con un plano que contiene el eje de una broca.
- **Parte plana:** la parte periférica del cuerpo entre canales adyacentes.
- **Ancho de la parte plana:** distancia entre el borde de entrada y el talón de la parte plana medida en ángulo recto al borde de entrada.
- **Entrada:** avance axial de un borde de entrada de la parte plana en una vuelta alrededor de la circunferencia.
- **Ángulo de alivio del labio:** ángulo de alivio axial en la esquina exterior del labio medido por proyección a un plano tangente a la periferia en la esquina exterior del labio.
- **Labios:** los filos de corte de una broca de dos canales que van desde el borde biselado hasta la periferia.
- **Margen:** parte cilíndrica de la parte plana que no se corta para ofrecer espacio libre.
- **Cuello:** sección de diámetro reducido entre el cuerpo y el mango de una broca.
- **Longitud total:** longitud desde el extremo del mango hasta las esquinas exteriores del labio de corte. No incluye el extremo de mango cónico que se suele utilizar en las brocas de mango recto, ni la punta de corte cónica que se utiliza en las brocas de mango recto y cónico.
- **Punta:** extremo de corte de una broca formado por los extremos de las partes planas y el alma. Su forma es similar a la de un cono, pero difiere de la de un verdadero cono para proporcionar un espacio libre detrás de los labios de corte.
- **Convencionales:** las puntas convencionales con ángulos de punta incluidos de 118° son las más utilizadas, ya que proporcionan resultados satisfactorios en una amplia variedad de materiales. Una posible limitación es que el borde biselado contribuye a que el punto de taladrado se desvíe, por lo que a menudo es necesario puntear el agujero para mejorar la precisión.

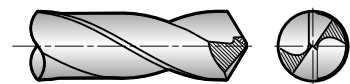
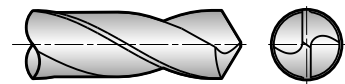

BROCAS DE METAL DURO Y HSS: INFORMACIÓN TÉCNICA

- **Ranuradas:** las puntas ranuradas se crearon para taladrar aleaciones resistentes. Normalmente se incorporan a las brocas de alma dura, lo que permite que la punta resista las mayores cargas de empuje que se requieren en el taladrado de estos materiales. Al igual que la punta dividida, la punta ranurada contiene dos filos de corte adicionales con ángulo de desprendimiento positivo que se extienden hacia el centro de la broca. Estos labios de corte secundarios —que no se prolongan más allá de la mitad del labio de corte original— pueden ayudar a controlar la viruta y reducir el par necesario para taladrar materiales difíciles de mecanizar. Las puntas ranuradas se pueden incorporar en puntas con ángulo de 118° y de 135°, por lo que son ideales para taladrar en una amplia variedad de materiales.

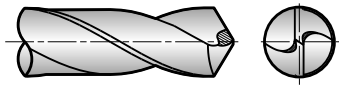

- **Ángulo de la punta:** el ángulo incluido entre los labios de corte proyectados sobre un plano paralelo al eje de la broca y paralelo a los dos labios de corte.
- **Altura de labio relativa:** diferencia en la lectura del indicador entre los labios de corte de una broca, medida en ángulo recto al labio de corte a una distancia específica desde el eje de la herramienta.
- **Mango:** la sección por la que se sujeta e impulsa la broca.
- **Espiga:** extremo aplanado de un mango cónico, destinado a encajar en una ranura de posicionamiento en un manguito.
- **Espiga de posicionamiento:** dos planos de arrastre paralelos opuestos en el extremo de un mango recto.
- **Mango cónico:** brocas con mango cónico, apropiadas para el montaje directo en husillos de máquinas, casquillos de arrastre o manguitos. Por lo general, los mangos cónicos llevan una espiga.
- **Alma:** porción central del cuerpo que actúa como unión de las partes planas. El extremo del alma forma el borde biselado en una broca de dos canales.
- **Espesor del alma:** el espesor del alma en la punta, salvo que se indique otra ubicación específica.

Indicaciones generales sobre el taladrado

1. Seleccione la broca más adecuada para la aplicación, teniendo en cuenta el material que se va a mecanizar, la capacidad de la máquina-herramienta y el refrigerante empleado.
2. La flexibilidad dentro del componente y del husillo de la máquina-herramienta puede provocar daños en la broca, así como en el componente y la máquina: asegúrese de que haya la máxima estabilidad en todo momento. Esta puede mejorarse seleccionando la broca más corta posible para la aplicación.
3. La sujeción de la herramienta es un aspecto importante de la operación de taladrado, por lo que no se puede permitir que la broca se deslice o se mueva en el portaherramientas.
4. El uso correcto de las brocas con mango cónico Morse depende de un ajuste perfecto entre las superficies cónicas de la herramienta y

el portaherramientas. Se debe utilizar un martillo suave para introducir la broca en el portaherramientas.

5. Se recomienda utilizar refrigerantes y lubricantes adecuados según lo requiera la operación de taladrado en cuestión. Cuando se utilicen refrigerantes y lubricantes, hay que asegurar un suministro abundante, especialmente en la punta de la broca.
6. La evacuación de las virutas durante el taladrado es esencial para garantizar un correcto proceso de taladrado. No permita que las virutas se queden estancadas en el canal.
7. Al reafilarse una broca, asegúrese siempre de que se genera la geometría de punta correcta y de que se ha eliminado cualquier rastro de desgaste.



Estrategia de taladrado de agujeros profundos

Al taladrar agujeros profundos, pueden adoptarse varios métodos para lograr la profundidad requerida. En el ejemplo se muestran cuatro formas de taladrar un agujero con una profundidad de 10 veces el diámetro de la broca.

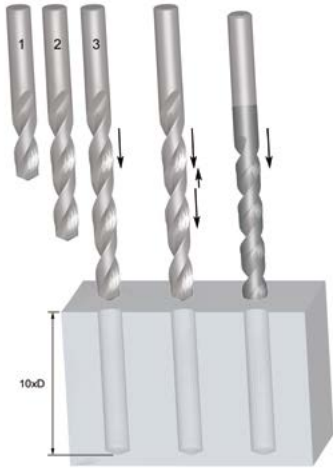

	Taladro en series	Taladro en series
Número de rocas	3 (2,5 ×D, 6 ×D,10 ×D)	2 (2,5 ×D,10 ×D)
Tipo de broca	Geometría estándar, aplicaciones generales	Geometría estándar, aplicaciones generales
+ / -	Caro Largo	Más rentable Rápido

	Taladro con desahogo (misma broca)	Taladro en 1 paso
Número de rocas	1 (10 ×D)	1 (10 ×D)
Tipo de broca	Geometría estándar, aplicaciones generales	Herramientas específicas
+ / -	Largo	Rentable Rápido

Problemas en el taladrado

PROBLEMA	CAUSA	REMEDIO
Rotura o torsión en la espiga	Malas condiciones entre el mango y el portaherramientas	Comprobar que el mango y el portaherramientas están limpios y no están dañados
Grietas en el alma de la herramienta	Avance demasiado alto	Reducir el avance a un valor óptimo
	Insuficiente holgura inicial	Reafilarse según las especificaciones correctas
	Alma excesivamente delgada	Reafilarse según las especificaciones correctas
	Duro impacto en la punta de la broca	Evitar impactos en la punta de la broca. Tener precaución con las brocas del mango cónico al introducirlas/expulsarlas del husillo
Desgaste en las esquinas exteriores	Excesiva velocidad	Reducir la velocidad al valor óptimo, debe poder incrementarse el avance
Rotura de las esquinas exteriores	Montaje de la herramienta inestable	Reducir el movimiento en el componente
Labios de corte astillados	Excesiva holgura inicial	Reafilarse según las especificaciones correctas
Rotura en la salida de la estría	Estrías atascadas	Adoptar un concepto de taladrado con desahogo/en serie
	Resbalamiento de la broca	Asegurar que la broca está bien sujeta en el portapinzas y el husillo
Acabado en espiral del agujero	Avance insuficiente	Incrementar el avance
	Exactitud del posicionamiento mala	Usar una broca de centrar antes del taladrado
Tamaño del agujero demasiado grande	Geometría de la punta incorrecta	Corregir la geometría de la punta
	Holgura de la viruta deficiente	Ajustar la velocidad y el avance y la longitud de desahogo para lograr una viruta más manejable



BROCAS DE METAL DURO Y HSS: INFORMACIÓN TÉCNICA

Tamaño de agujero y tolerancias de agujero posibles

A medida que las configuraciones geométricas, de sustrato y de recubrimiento son más avanzadas, aumenta la capacidad de una broca para producir un tamaño de agujero más preciso. En general, una herramienta de geometría estándar conseguirá un tamaño de agujero

hasta H12. Sin embargo, a medida que la configuración de la broca se hace más compleja, el tamaño de agujero que puede lograrse —en condiciones favorables— puede llegar a ser de H8.

Para ofrecer una mejor perspectiva, a continuación se enumeran los tipos de productos y sus tolerancias de agujero posibles:

Brocas genéricas de HSS: H12

Brocas de agujero profundo de HSS/HSCo con canal parabólico (PFX): H10

Brocas de HSS/HSCo de alto rendimiento con recubrimiento de TiN/TiAlN (ADX): H10

Brocas de metal duro de alto rendimiento con recubrimiento de TiN/TiAlN (CDX, Force): H8/H9

Diámetro de agujero nominal (mm)

Ø (mm)	H8	H9	H10	H12
≤ 3	0 / +0.014	0 / +0.025	0 / +0.040	0 / +0.100
> 3 ≤ 6	0 / +0.018	0 / +0.030	0 / +0.048	0 / +0.120
> 6 ≤ 10	0 / +0.022	0 / +0.036	0 / +0.058	0 / +0.150
> 10 ≤ 18	0 / +0.027	0 / +0.043	0 / +0.070	0 / +0.180
> 18 ≤ 30	0 / +0.033	0 / +0.052	0 / +0.084	0 / +0.210

Diámetro de agujero nominal (pulgadas)

Ø (pulgadas)	H8	H9	H10	H12
≤ .1181	0 / +0.0006"	0 / +0.0010"	0 / +0.0016"	0 / +0.0040"
>.1181≤.2362	0 / +0.0007"	0 / +0.0012"	0 / +0.0019"	0 / +0.0048"
>.2362≤.3937	0 / +0.0009"	0 / +0.0015"	0 / +0.0023"	0 / +0.0059"
>.3937≤.7087	0 / +0.0011"	0 / +0.0017"	0 / +0.0028"	0 / +0.0071"
>.7087≤1.1811	0 / +0.0013"	0 / +0.0021"	0 / +0.0033"	0 / +0.0083"

En vista de la capacidad de algunas brocas para obtener una tolerancia de agujero mucho más ajustada, se debe prestar la debida atención a los agujeros perforados que están sujetos a operaciones secundarias, por ejemplo, el roscado con macho o el escariado. En

estos casos, será necesario aumentar el diámetro de la broca con respecto al recomendado para compensar el hecho de que el tamaño del agujero producido será menor.

Optimización del proceso de taladrado y resolución de problemas

Selección de brocas

Utilice la broca más corta que permita la aplicación para conseguir la máxima rigidez de la herramienta.

Portaherramientas

Los portaherramientas y las pinzas deben garantizar una buena concentricidad entre la broca y el husillo de la máquina. Utilice un tope trasero positivo para evitar que la herramienta retroceda en el portaherramientas. No sujete nunca la herramienta sobre los canales ni apriete demasiado el portaherramientas. Se debe comprobar y mantener con precisión la excentricidad estática en el conjunto de la herramienta.

Pieza

Se necesita una pieza segura y rígida para minimizar la deflexión, es-

pecialmente en las aplicaciones con agujeros pasantes.

Refrigerantes

El uso de refrigerantes se recomienda al taladrar acero dulce y aleaciones termorresistentes. El cometido del medio refrigerante es dirigir las virutas lejos de la herramienta de corte y la pieza. Una presión excesiva del refrigerante y/o un volumen excesivo pueden afectar negativamente al rendimiento. Cuando se utilizan brocas alimentadas con refrigerante, la presión del refrigerante que se requiere debe ser más alta de lo normal. La presión recomendada para las brocas alimentadas con refrigerante es como mínimo de 10,3 bar o 150 PSI. A medida que se reduce el diámetro de la broca, aumenta la presión. Esto ayuda a evacuar las virutas de una zona más reducida.



BROCAS DE METAL DURO Y HSS: INFORMACIÓN TÉCNICA

Guía de resolución de problemas de taladrado

Problema	Solución
Desgaste en las esquinas exteriores	Reducir la velocidad de corte
	Aumentar el avance (IPR)
	Mejorar la dirección de flujo del refrigerante
	Aumentar la presión del refrigerante
	Añadir un refuerzo en la esquina
Virutas en el borde biselado	Comprobar la exactitud de la excentricidad de la broca
	Comprobar la precisión de la sujeción de la pieza y su movimiento
	Comprobar la centralidad en la punta y la altura del labio
	Aumentar la velocidad de avance
Virutas en los labios de corte	Comprobar la exactitud de la excentricidad de la broca
	Comprobar la precisión de la sujeción de la pieza y su movimiento
	Reducir la velocidad
	Reducir el espacio libre en la punta
	Aumentar el rectificado (honing)
Grietas en las partes planas	Comprobar el movimiento de la pieza
	Aumentar el chafán de salida
	Comprobar la exactitud de la excentricidad de la broca
	Compactar las virutas; aumentar la abertura de la forma del canal o de la broca de taladro profundo (solo HSS o HSCO)
	Disminuir la velocidad de la hélice, taladrar horizontalmente
	Aumentar el avance
	Al puntear, reducir la velocidad
	Mejorar la dirección de flujo del refrigerante
Aumentar la presión del refrigerante	
Agujero sobredimensionado	Aumentar la velocidad, reducir el avance
	Comprobar la precisión de la sujeción de la pieza y su movimiento
	Comprobar la exactitud de la excentricidad de la broca
	Compactar las virutas, aumentar la abertura de la forma del canal o de la broca de taladro profundo (solo HSS o HSCO)
	Comprobar la centralidad en la punta y la altura del labio
Agujero infradimensionado	Mejorar la dirección de flujo del refrigerante
	Reducir la velocidad de corte, aumentar el avance
	Comprobar el diámetro de broca
El agujero no es redondo	Comprobar la exactitud de la excentricidad de la broca
	Comprobar la precisión de la sujeción de la pieza y su movimiento
	Comprobar la centralidad en la punta y la altura del labio
	Compactar las virutas, aumentar la abertura de la forma del canal o de la broca de taladro profundo (solo HSS o HSCO)
Rotura de la broca	Compactar las virutas, aumentar la abertura de la forma del canal o de la broca de taladro profundo (solo HSS o HSCO)
	Comprobar la precisión de la sujeción de la pieza y su movimiento
	Comprobar la exactitud de la excentricidad de la broca
	Reducir la velocidad de avance, aumentar la velocidad de avance
	Mejorar la dirección de flujo del refrigerante
	Aumentar la presión del refrigerante



INFORMACIÓN TÉCNICA GENERAL

	Calidad	Dureza (HV10)	C %	W %	Mo %	Cr %	V %	Co %	Material de la herramienta
	M2	810 – 850	0.9	6.4	5.0	4.2	1.8	–	HSS
	M35	830 – 870	0.93	6.4	5.0	4.2	1.8	4.8	HSCO
	M42	870 – 960	1.08	1.5	9.4	3.9	1.2	8.0	

Propiedades	Materiales HSS	Materiales de metal duro	K10/30F (se suele utilizar para herramientas duras)
Dureza (HV30)	800-950	1300 – 1800	1600
Densidad (g/cm ³)	8.0 – 9.0	7.2 – 15	14.45
Fuerza de compresión (N/mm ²)	3000 – 4000	3000 – 8000	6250
Resistencia a la flexión, (flexión) (N/mm ²)	2500 – 4000	1000 – 4700	4300
Resistencia al calor (°C)	550	1000	900
Módulo eléctrico (KN/mm ²)	260 – 300	460 – 630	580
Tamaño de grano (µm)	–	0.2 – 10	0.8

La combinación de la partícula dura (WC) y el metal aglutinante (Co) provoca los siguientes cambios en las características.

Característica	Un mayor contenido de WC	Un mayor contenido de Co
Dureza	Mayor dureza	Menor dureza
Fuerza de compresión (CS)	Mayor CS	Menor CS
Resistencia a la flexión (BS)	Menor BS	Mayor BS

El tamaño de grano también influye en las propiedades del material. Los tamaños de grano pequeños se traducen en una mayor dureza y los granos gruesos, en una mayor tenacidad.

Tratamiento de la superficie y ejemplos de propiedades del recubrimiento

Tratamientos de la superficie	Color	Material de recubrimiento	Dureza (HV)	Espesor (µm)	Estructura del recubrimiento	Coefficiente de fricción respecto al acero	Temp. aplic. máx. (°C)
	Gris oscuro	Fe 304	400	Máx. 5	Conversión en la superficie	–	550
	Bronce	Fe 304	400	Máx. 5	Conversión en la superficie	–	550
	Oro	TiN	2300	1-4	Monocapa	0.4	600
	Gris negruzco	TiAlN	3300	3	Nanoestructura	0.3-0.35	900



INFORMACIÓN TÉCNICA GENERAL

Tolerancias estándar de la industria para ejes y agujeros

Los valores de tolerancia se indican en micras (μm)

Fórmula para las micras ...1 $\mu\text{m} = 0,001 \text{ mm} / 0,000039''$

Tolerancia	Diámetro (mm)							
	> 1 ≤ 3	> 3 ≤ 6	> 6 ≤ 10	> 10 ≤ 18	> 18 ≤ 30	> 30 ≤ 50	> 50 ≤ 80	> 80 ≤ 120
	Diámetro (pulgadas)							
	> 0.039" ≤ 0.118"	> 0.118" ≤ 0.236"	> 0.236" ≤ 0.394"	> 0.394" ≤ 0.709"	> 0.709" ≤ 1.181"	> 1.181" ≤ 1.968"	> 1.968" ≤ 3.149"	> 3.149" ≤ 4.724"
Valores de tolerancia (μm)								
e8	-14 / -28	-20 / -38	-25 / -47	-32 / -59	-40 / -73	-50 / -89	-60 / -106	-72 / -126
f6	-6 / -12	-10 / -18	-13 / -22	-16 / -27	-20 / -33	-25 / -41	-30 / -49	-36 / -58
f7	-6 / -16	-10 / -22	-13 / -28	-16 / -34	-20 / -41	-25 / -50	-30 / -60	-36 / -71
h6	0 / -6	0 / -8	0 / -9	0 / -11	0 / -13	0 / -16	0 / -19	0 / -22
h7	0 / -10	0 / -12	0 / -15	0 / -18	0 / -21	0 / -25	0 / -30	0 / -35
h8	0 / -14	0 / -18	0 / -22	0 / -27	0 / -33	0 / -39	0 / -46	0 / -54
h9	0 / -25	0 / -30	0 / -36	0 / -43	0 / -52	0 / -62	0 / -74	0 / -87
h10	0 / -40	0 / -48	0 / -58	0 / -70	0 / -84	0 / -100	0 / -120	0 / -140
h11	0 / -60	0 / -75	0 / -90	0 / -110	0 / -130	0 / -160	0 / -190	0 / -220
h12	0 / -100	0 / -120	0 / -150	0 / -180	0 / -210	0 / -250	0 / -300	0 / -350
k10	+40 / 0	+48 / 0	+58 / 0	+70 / 0	+84 / 0	+100 / 0	+120 / 0	+140 / 0
k12	+100 / 0	+120 / 0	+150 / 0	+180 / 0	+210 / 0	+250 / 0	+300 / 0	+350 / 0
m7	+2 / +12	+4 / +16	+6 / +21	+7 / +25	+8 / +29	+9 / +34	+11 / +41	+13 / +48
js14	+/-125	+/-150	+/-180	+/-215	+/-260	+/-310	+/-370	+/-435
js16	+/-300	+/-375	+/-450	+/-550	+/-650	+/-800	+/-950	+/-1100
H7	+10 / 0	+12 / 0	+15 / 0	+18 / 0	+21 / 0	+25 / 0	+30 / 0	+35 / 0
H8	+14 / 0	+18 / 0	+22 / 0	+27 / 0	+33 / 0	+39 / 0	+46 / 0	+54 / 0
H9	+25 / 0	+30 / 0	+36 / 0	+43 / 0	+52 / 0	+62 / 0	+74 / 0	+87 / 0
H12	+100 / 0	+120 / 0	+150 / 0	+180 / 0	+210 / 0	+250 / 0	+300 / 0	+350 / 0
P9	-6 / -31	-12 / -42	-15 / -51	-18 / -61	-22 / -74	-26 / -86	-32 / -106	-37 / -124
S7	-13 / -22	-15 / -27	-17 / -32	-21 / -39	-27 / -48	-34 / -59	-42 / -72	-58 / -93



INFORMACIÓN TÉCNICA GENERAL

Tabla de velocidades de corte

		Vc															
m/min		5	8	10	15	20	25	30	40	50	60	70	80	90	100	110	150
SFM (pies/min)		16	26	32	50	66	82	98	130	165	197	230	262	296	330	362	495
Ø		RPM															
mm	pulgadas																
1.00	—	1592	2546	3183	4775	6366	7958	9549	12732	15916	19099	22282	25465	28648	31831	35014	47747
1.50	—	1061	1698	2122	3183	4244	5305	6366	8488	10610	12732	14854	16977	19099	21221	23343	31831
2.00	—	796	1273	1592	2387	3183	3979	4775	6366	7958	9549	11141	12732	14324	15916	17507	23873
2.50	—	637	1019	1273	1910	2546	3183	3820	5093	6366	7639	8913	10186	11459	12732	14006	19099
3.00	—	531	849	1061	1592	2122	2653	3183	4244	5305	6366	7427	8488	9549	10610	11671	15916
3.18	1/8	500	801	1001	1501	2002	2502	3003	4004	5005	6006	7007	8008	9009	10010	11011	15015
3.50	—	455	728	909	1364	1819	2274	2728	3638	4547	5457	6366	7276	8185	9095	10004	13642
4.00	—	398	637	796	1194	1592	1989	2387	3183	3979	4775	5570	6366	7162	7958	8754	11937
4.50	—	354	566	707	1061	1415	1768	2122	2829	3537	4244	4951	5659	6366	7074	7781	10610
4.76	3/16	334	535	669	1003	1337	1672	2006	2675	3344	4012	4681	5350	6018	6687	7356	10031
5.00	—	318	509	637	955	1273	1592	1910	2546	3183	3820	4456	5093	5730	6366	7003	9549
6.00	—	265	424	531	796	1061	1326	1592	2122	2653	3183	3714	4244	4775	5305	5836	7958
6.35	1/4	251	401	501	752	1003	1253	1504	2005	2506	3008	3509	4010	4511	5013	5514	7519
7.00	—	227	364	455	682	909	1137	1364	1819	2274	2728	3183	3638	4093	4547	5002	6821
7.94	5/16	200	321	401	601	802	1002	1203	1604	2004	2405	2806	3207	3608	4009	4410	6013
8.00	—	199	318	398	597	796	995	1194	1592	1989	2387	2785	3183	3581	3979	4377	5968
9.00	—	177	283	354	531	707	884	1061	1415	1768	2122	2476	2829	3183	3537	3890	5305
9.53	3/8	167	267	334	501	668	835	1002	1336	1670	2004	2338	2672	3006	3340	3674	5010
10.00	—	159	255	318	477	637	796	955	1273	1592	1910	2228	2546	2865	3183	3501	4775
11.11	7/16	143	229	287	430	573	716	860	1146	1433	1719	2006	2292	2579	2865	3152	4298
12.00	—	133	212	265	398	531	663	796	1061	1326	1592	1857	2122	2387	2653	2918	3979
12.70	1/2	125	201	251	376	501	627	752	1003	1253	1504	1754	2005	2256	2506	2757	3760
14.00	—	114	182	227	341	455	568	682	909	1137	1364	1592	1819	2046	2274	2501	3410
14.29	9/16	111	178	223	334	446	557	668	891	1114	1337	1559	1782	2005	2228	2450	3341
15.00	—	106	170	212	318	424	531	637	849	1061	1273	1485	1698	1910	2122	2334	3183
15.88	5/8	100	160	200	301	401	501	601	802	1002	1203	1403	1604	1804	2004	2205	3007
16.00	—	99	159	199	298	398	497	597	796	995	1194	1393	1592	1790	1989	2188	2984
17.46	11/16	91	146	182	273	365	456	547	729	912	1094	1276	1458	1641	1823	2005	2735
18.00	—	88	141	177	265	354	442	531	707	884	1061	1238	1415	1592	1768	1945	2653
19.05	3/4	84	134	167	251	334	418	501	668	835	1003	1170	1337	1504	1671	1838	2506
20.00	—	80	127	159	239	318	398	477	637	796	955	1114	1273	1432	1592	1751	2387
24.00	—	66	106	133	199	265	332	398	531	663	796	928	1061	1194	1326	1459	1989
25.00	—	64	102	127	191	255	318	382	509	637	764	891	1019	1146	1273	1401	1910
27.00	—	59	94	118	177	236	295	354	472	589	707	825	943	1061	1179	1297	1768
30.00	—	53	85	106	159	212	265	318	424	531	637	743	849	955	1061	1167	1592
32.00	—	50	80	99	149	199	249	298	398	497	597	696	796	895	995	1094	1492
36.00	—	44	71	88	133	177	221	265	354	442	531	619	707	796	884	973	1326
40.00	—	40	64	80	119	159	199	239	318	398	477	557	637	716	796	875	1194
50.00	—	32	51	64	95	127	159	191	255	318	382	446	509	573	637	700	955



INFORMACIÓN TÉCNICA GENERAL

Dureza y resistencia a la tracción

HV	HRC	HB	Resistencia	
			N/mm ²	Toneladas/sq. in.
940	68	–	–	–
900	67	–	–	–
864	66	–	–	–
829	65	–	–	–
800	64	–	–	–
773	63	–	–	–
745	62	–	–	–
720	61	–	–	–
698	60	–	–	–
675	59	–	–	–
655	58	–	2200	142
650	–	618	2180	141
640	–	608	2145	139
639	57	607	2140	138
630	–	599	2105	136
620	–	589	2070	134
615	56	584	2050	133
610	–	580	2030	131
600	–	570	1995	129
596	55	567	1980	128
590	–	561	1955	126
580	–	551	1920	124
578	54	549	1910	124
570	–	542	1880	122
560	53	532	1845	119
550	–	523	1810	117
544	52	517	1790	116
540	–	513	1775	115
530	–	504	1740	113
527	51	501	1730	112
520	–	494	1700	110
514	50	488	1680	109
510	–	485	1665	108
500	–	475	1630	105
497	49	472	1620	105
490	–	466	1595	103
484	48	460	1570	102
480	–	456	1555	101
473	47	449	1530	99
470	–	447	1520	98
460	–	437	1485	96
458	46	435	1480	96
450	–	428	1455	94
446	45	424	1440	93
440	–	418	1420	92

HV	HRC	HB	Resistencia	
			N/mm ²	Toneladas/sq. in.
434	44	413	1400	91
423	43	402	1360	88
413	42	393	1330	86
403	41	383	1300	84
392	40	372	1260	82
382	39	363	1230	80
373	38	354	1200	78
364	37	346	1170	76
355	36	337	1140	74
350	–	333	1125	73
345	35	328	1110	72
340	–	323	1095	71
336	34	319	1080	70
330	–	314	1060	69
327	33	311	1050	68
320	–	304	1030	67
317	32	301	1020	66
310	31	295	995	64
302	30	287	970	63
300	–	285	965	62
295	–	280	950	61
293	29	278	940	61
290	–	276	930	60
287	28	273	920	60
285	–	271	915	59
280	27	266	900	58
275	–	261	880	57
272	26	258	870	56
270	–	257	865	56
268	25	255	860	56
265	–	252	850	55
260	24	247	835	54
255	23	242	820	53
250	22	238	800	52
245	–	233	785	51
243	21	231	780	50
240	–	228	770	50
235	–	223	755	49
230	–	219	740	48
225	–	214	720	47
220	–	209	705	46
215	–	204	690	45
210	–	199	675	44
205	–	195	660	43
200	–	190	640	41



ACEITES DE CORTE



M200-1



M200 no. 1 Azul, Aceite de Corte para Mecanizado Pesado

Un aceite de corte de alto rendimiento para operaciones difíciles, como roscado, brochado y taladrado, a mano o en un taladro de columna. Para una mayor vida útil de la herramienta y mejores acabados superficiales. Primera elección para acero de alta resistencia, acero inoxidable y superaleaciones.

Producto	Nr.
M2000.25NR.1BLUE	1/4 Ltr. 12x
M2001.0NR.1BLUE	1 Ltr.
M2005.0NR.1BLUE	5 Ltr.
M20020.0NR.1BLUE	20 Ltr.

M200-2



M200 no. 2 Rojo, Aceite de Corte para Mecanizado de Metales No Férreos

Un aceite puro para operaciones de mecanizado que requieren la eliminación de virutas en aluminio y sus aleaciones. Proporciona lubricación y enfriamiento para prolongar la vida útil de la herramienta y garantizar un excelente acabado superficial. Bajo impacto en el medio ambiente debido a excelentes propiedades anti-vaho, alta estabilidad a la oxidación y bajos olores.

Producto	Nr.
M2000.25NR.2RED	1/4 Ltr. 12x
M2001.0NR.2RED	1 Ltr.
M2005.0NR.2RED	5 Ltr.



M200-3



M200 no. 3 Verde, Aceite de Corte para Mecanizado de Uso General

Un aceite de corte de alto rendimiento con aditivos de extrema presión (EP) para prolongar la vida útil de la herramienta. Para operaciones generales de corte o conformado, como roscado, brochado y taladrado en acero o acero fundido y acero inoxidable.

Producto	Nr.
M2000.25NR.3GREEN	1/4 Ltr. 12x
M2001.0NR.3GREEN	1 Ltr.
M2005.0NR.3GREEN	5 Ltr.



DORMER PRAMET



CONQUISTANDO EL CIELO

Hemos añadido cientos de nuevos productos a nuestra gama global de herramientas de corte, especialmente para aplicaciones de estructuras de aeronaves y montaje. Todos ellos se detallan en una nueva publicación, que ya está disponible para descargar.

Simplemente fiables.





ESCARIADORES Y AVELLANDADORES





MECANIZADO DE AGUJEROS: ÍNDICE GENERAL

6		WMG E ISO 13399
12	BROCAS	INSTRUCCIONES
15		BROCAS DE METAL DURO INTEGRAL
66		BROCAS DE HSS
176		INFORMACIÓN TÉCNICA
186		ACEITES DE CORTE
190		ESCARIADORES Y AVELLANADORES
264	BROCAS DE PLAQUITA INTERCAMBIABLE	INSTRUCCIONES
271		BROCAS HYDRA
297		INFORMACIÓN TÉCNICA
307		BROCAS DE PLAQUITA INTERCAMBIABLE
327		INFORMACIÓN TÉCNICA
350	SISTEMAS DE MANDRILADO	INSTRUCCIONES
359		CABEZALES DE MANDRINADO
376		ACCESORIOS DE MANDRINADO
381		PLAQUITAS DE CORTE
404		ÚTILES DE SUJECCIÓN
418		KITS DE MANDRINADO
429		INFORMACIÓN TÉCNICA



ESARIADORES Y AVELLANADORES: PÁGINA RESUMEN

1

B400

DORMER



3

Escariador de Máquina de Metal Duro, Espacio Desigual, con Tolerancia H7, Acabado Brillante

Diseñado para proporcionar un acabado dentro de los límites de la tolerancia H7. Para un rendimiento superior y una mayor vida útil de la herramienta al escariar materiales duros y abrasivos. El diseño helicoidal, con un espaciado extremadamente desigual entre los canales, reduce la vibración y mejora la redondez del agujero, el tamaño y el acabado superficial.

2

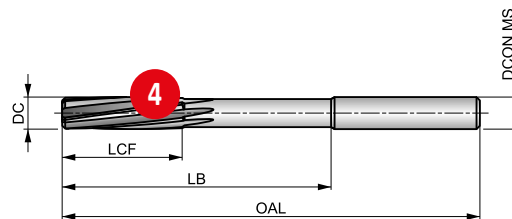

HM	Bright	DIN 8093
R	B	
H7		

Grupo de Material de la pieza adecuado y condiciones de velocidad de corte iniciales (m/min) y código de avance alfabético. Tablas con avance por revolución a partir de la pag.251.

P1.1 ■ 23 B	P1.2 ■ 26 B	P1.3 ■ 27 B	P2.1 ■ 20 B	P2.2 ■ 18 B	P2.3 ■ 16 C	P3.1 ■ 16 B	P3.2 ■ 13 B	P3.3 ■ 11 C	P4.1 ■ 10 B	P4.2 ■ 8 C	P4.3 ■ 7 C	M1.1 ■ 10 C	M1.2 ■ 8 C
M2.1 ■ 9 C	M2.2 ■ 7 C	M2.3 ■ 16 B	K1.1 ■ 20 D	K1.2 ■ 15 D	K1.3 ■ 11 D	K2.1 ■ 20 D	K2.2 ■ 17 D	K2.3 ■ 14 D	K3.1 ■ 18 D	K3.2 ■ 14 D	K3.3 ■ 11 D	K5.1 ■ 19 D	K5.2 ■ 15 D
K5.3 ■ 11 D	N1.1 ■ 60 D	N1.2 ■ 45 D	N1.3 ■ 30 D	N2.1 ■ 38 D	N2.2 ■ 35 D	N2.3 ■ 25 D	N3.1 ■ 64 E	N3.2 ■ 38 E	N3.3 ■ 19 E	N4.1 ■ 35 C	N4.2 ■ 30 C		

DCON MS tolerancia h6; DC >= 14 mm con Punta de Metal Duro

Product	DC	OAL	LCF	LB	NOF	DCON MS
	[mm]	[mm]	[mm]	[mm]		[mm]
B4001.0	1.00	34.0	5.5	15.00	3	1.00
B4001.2	1.20	38.0	7.5	16.50	3	1.20
B4001.4	1.40	40.0	8.0	18.00	3	1.50
B4001.5	1.50	40.0	8.0	18.00	3	1.50
B4001.6	1.60	43.0	9.0	20.00	3	1.60
B4001.8	1.80	46.0	10.0	22.00	4	1.80
B4002.0	2.00	49.0	11.0	24.00	4	2.00
B4002.2	2.20	53.0	12.0	25.00	4	2.20
B4002.5	2.50	57.0	14.0	27.00	4	2.50
B4003.0	2.80	61.0	15.0	30.00	6	3.00
B4003.0	3.00	61.0	15.0	33.00	6	3.00
B4003.2	3.20	65.0	16.0	37.00	6	3.20

Product	DC	OAL	LCF	LB	NOF	DCON MS
	[mm]	[mm]	[mm]	[mm]		[mm]
B4004.5	4.50	80.0	21.0	52.00	6	4.50
B4005.0	5.00	86.0	23.0	58.00	6	5.00
B4005.5	5.50	93.0	26.0	57.00	6	5.60
B4006.0	6.00	93.0	26.0	57.00	6	5.60
B4006.5	6.50	101.0	28.0	65.00	6	6.30
B4007.0	7.00	109.0	31.0	73.00	6	7.10
B4008.0	8.00	117.0	33.0	81.00	6	8.00
B4009.0	9.00	125.0	36.0	85.00	6	9.00
B40010.0	10.00	133.0	38.0	93.00	6	10.00
B40012.0	12.00	151.0	44.0	111.00	6	10.00
B40014.0	14.00	160.0	47.0	115.00	6	12.50
B40016.0	16.00	170.0	52.0	125.00	6	12.50

Pos.	Descripción
1	Denominación
2	Descripción del producto
3	Imagen
4	Representación esquemática de la herramienta

Pos.	Descripción
5	Características del producto
6	Recomendaciones de grupos de materiales, incluidas la velocidad de avance y la guía de avance
7	Código de producto
8	Dimensiones del producto



ESCARIADORES Y AVELLANADORES: RESUMEN DE SÍMBOLOS

SÍMBOLOS GENERALES

	Uso principal
	Uso posible

TOLERANCIA DE AGUJERO POSIBLE(TCHA)

	H7 - Clase de tolerancia de agujero estándar en la industria (en función del margen de diámetros)		k11 - Clase de tolerancia de la herramienta estándar en la industria (en función del margen de diámetros)
	Clase de tolerancia de agujero de alta precisión (en función del margen de diámetros)		

ÁNGULO DE APLICACIÓN

	Avellanador de 100°		Broca cónica de 20°		Avellanador de 82°
	Escariado de 180°		Avellanador de 60°		Avellanador de 90°

GRUPO DE NORMAS BÁSICO (BSG)

	ANSI - Norma		DIN 219 - Normas sobre escariadores huecos		DIN 8050 - Normas sobre escariadores con mango paralelo
	BS 328 - Normas sobre brocas y escariadores		DIN 311 - Normas sobre escariadores guiados con mango cónico Morse		DIN 8051 - Normas sobre escariadores con mango cónico Morse
	DIN 206 - Normas sobre escariadores manuales		DIN 334 C - Normas sobre avellanadores con mango recto		DIN 8093 - Normas sobre escariadores con mango recto
	DIN 208 - Normas sobre escariadores con mango cónico Morse		DIN 334 D - Normas sobre avellanadores con mango cónico Morse		DIN 8094 - Normas sobre escariadores con mango cónico Morse
	DIN 212 - Normas sobre escariadores de máquina		DIN 335 A - Normas sobre avellanadores con mango recto		DIN 9 - Normas sobre escariadores para pasadores cónicos
	DIN 217 - Normas sobre portaescariadores para escariadores huecos		DIN 335 C - Normas sobre avellanadores con mango recto		Normas Dormer
	DIN 2179 - Normas sobre escariadores para pasadores cónicos con mango paralelo		DIN 335 D - Normas sobre avellanadores con mango cónico Morse		
	DIN 2180 - Normas sobre escariadores para pasadores cónicos con mango cónico Morse		DIN 373 - Normas sobre escariado		

RECUBRIMIENTO

	Recubrimiento de carbonitruro de titanio y aluminio		Combinación brillante y templado al vapor		Recubrimiento de nitruro de aluminio y titanio
	Brillante (sin recubrimiento)		Tratamiento de la superficie con vapor y óxido de bronce		Recubrimiento de nitruro de titanio

DIRECCIÓN DE CORTE







	Giro/corte a la derecha
--	-------------------------

CÓDIGO DE MATERIAL (BMC)



	Metal duro		Acero rápido
	Acero rápido al cobalto		



ESCARIADORES Y AVELLANADORES: RESUMEN DE SÍMBOLOS

FORMA DEL ESCARIADOR		MANGO	
A	DIN Forma A - Canal recto $\leq \varnothing 3,5$ mm	 Mango cilíndrico/mango recto	 Mango cilíndrico con espiga
B	DIN Forma B - Canal helicoidal $\leq \varnothing 3,5$ mm	 Mango cilíndrico con tres caras planas	 DIN 6535 HA mango cilíndrico
E	DIN Forma C - Canal recto $\geq \varnothing 4,0$ mm	 Mango cilíndrico con cara hexagonal	 Mango cónico Morse
		 Mango cilíndrico con cara cuadrada	



GRADIENTE DE CONICIDAD - EN MILÍMETROS (TASA DE CONICIDAD)

1:48 	Gradiente de conicidad (conicidad de 1/4" por pie)	1:50 	Gradiente de conicidad (conicidad de 1 mm por 50 mm)
-------------------------------------------------------------------------------------------------	----------------------------------------------------	--------------------------------------------------------------------------------------------------	------------------------------------------------------



ESCARIADORES Y AVELLANADORES: NAVEGADOR DE MATERIALES DE HERRAMIENTA

Materiales de herramientas

Acero rápido	 HSS	Se trata de un acero rápido de aleación media que presenta una buena maquinabilidad y un excelente rendimiento. El HSS presenta características de dureza, tenacidad y resistencia al desgaste que lo hacen atractivo en una amplia variedad de aplicaciones, por ejemplo en brocas y machos de roscar.
Acero rápido al cobalto	 HSS-E	Este acero rápido contiene cobalto para aumentar la dureza en caliente. La composición del HSCo proporciona una buena combinación de tenacidad y dureza. Posee una buena maquinabilidad y una elevada resistencia al desgaste, lo que lo hace apropiado para brocas, machos de roscar, fresas y escariadores.

Materiales de metal duro

Materiales de metal duro (o materiales duros)	 HM	<p>Un sustrato pulvimetalúrgico sinterizado, formado por un compuesto de carburo metálico con metal aglutinante. La materia prima más importante es el carburo de tungsteno (WC). El carburo de tungsteno contribuye al endurecimiento del material. El carburo de tántalo (TaC), el carburo de titanio (TiC) y el carburo de niobio (NbC) complementan al WC y adaptan sus propiedades según se desee. Estos tres materiales se conocen como carburos cúbicos. El cobalto (Co) actúa como aglutinante y mantiene el material unido.</p> <p>Los materiales de carburo suelen caracterizarse por su alta resistencia a la compresión, su elevada dureza y, por tanto, su alta resistencia al desgaste, pero también por su limitada resistencia a la flexión y por su tenacidad. El carburo se utiliza en machos de roscar, escariadores, fresas, brocas y fresas de roscar.</p>
------------------------------------------------------	--------------------------------------------------------------------------------------	---------------------------------------------------------------------------------------------------------------------------------------------------------------------------------------------------------------------------------------------------------------------------------------------------------------------------------------------------------------------------------------------------------------------------------------------------------------------------------------------------------------------------------------------------------------------------------------------------------------------------------------------------------------------------------------------------------------------------------------------------------------------------------------------------------------------------------------------------------------------------------

Recubrimientos superficiales

Nitruro de titanio (TiN)	 TiN	El nitruro de titanio es un recubrimiento cerámico de color dorado que se aplica por deposición física de vapor (PVD). La alta dureza, combinada con las propiedades de baja fricción, garantizan una vida útil considerablemente más larga de la herramienta o, alternativamente, un mejor rendimiento de corte de las herramientas que no están recubiertas. El recubrimiento de TiN se emplea principalmente para brocas y machos de roscar.
Carbonitruro de titanio-aluminio (AlTiCN)	 AlTiCN	El carbonitruro de titanio-aluminio (AlTiCN) es un recubrimiento de PVD diseñado específicamente para cumplir los rigurosos requisitos de la industria de los dispositivos médicos. Sin embargo, se puede utilizar también para determinadas operaciones de corte gracias a una tecnología de película fina de alta calidad, con excelentes características de microdureza y adherencia.
Recubrimientos de nitruro de aluminio y titanio (TiAlN)	 TiAlN	El nitruro de aluminio y titanio es un recubrimiento cerámico multicapa aplicado mediante la tecnología de recubrimiento PVD, que presenta una gran tenacidad y estabilidad a la oxidación. Estas propiedades lo convierten en ideal para alcanzar velocidades y avances más rápidos, al tiempo que mejora la vida útil de la herramienta. El TiAlN se utiliza en aplicaciones de taladrado, roscado con macho y fresado y es apropiado para el mecanizado sin refrigerante.
Brillante (sin recubrimiento)	 Bright	El acabado brillante (superficie sin recubrimiento) mejora el flujo de virutas en materiales suaves o materiales no férreos, a la vez que mantiene afilados los filos de corte.
Combinación de brillante y templado al vapor	 Bright ST	La combinación del recubrimiento brillante y el tratamiento de templado al vapor puede ser eficaz, ya que la superficie de óxido azul —más porosa— actúa para retener y guiar el fluido de corte hacia el interior del agujero, mientras que la superficie brillante ayuda a la evacuación de la viruta. Esta combinación se consigue rectificando la superficie brillante después del proceso de templado.
Tratamiento de la superficie con una combinación de vapor y bronce templado	 ST Bronze	La combinación de vapor y templado de bronce puede ser eficaz, ya que la superficie de óxido azul —más porosa— actúa para retener y guiar el fluido de corte hacia el interior del agujero, mientras que la superficie de bronce ayuda a la evacuación de la viruta. Ambos tratamientos de la superficie añaden un grado de protección a la superficie de la herramienta. Estas combinaciones se consiguen utilizando dos ciclos de templado diferentes.



Código de Material (BMC)	HM	HM	HM	HM	HM	HSS	HSS	HSS	HSS-E	HSS	HSS	HSS	HSS
Recubrimiento	Bright	Bright	Bright	Bright	Bright	Bright ST	Bright		Bright ST	Bright ST	Bright ST	Bright	ST Bronze
Grupo básico estándar (BSG)	DIN 8093	DIN 8093	DIN 8050	DIN 8094	DIN 8051	DIN 206	DORMER	DORMER	BS 328	BS 328	DIN 9	DIN 9	ANSI
Mano (dirección de corte)	R	R	R	R	R	R	R		R	R	R	R	R
Mango													
Ángulo de aplicación													
Forma del Escariador	B	B	A	B	A	B			B	A	A	B	
Tolerancia del agujero alcanzable (TCHA)	H7	$\begin{matrix} \phi.95-5.5 \\ +0.004 \\ \phi5.51-12 \\ +0.005 \end{matrix}$	H7	H7	H7	H7			H7				
Gradiente cónico - milímetro (conicidad)										1:48	1:50	1:50	
Código de Familia de Producto	B400	B481	B441	B411	B442	B100	B334	B335	B901	B301	B903	B952	B122
	1.00 - 20.00	0.98 - 12.05	10.00 - 20.00	5.00 - 30.00	10.00 - 20.00	1.50 - 50.00	N000 - N16	N000BLADES - N16NUT	1.50 - 1/2	1/16 - 1/2	1.50 - 20.00	1.20 - 50.00	3/8 - 1.1/16
	200	201	203	204	205	206	208	209	210	211	212	213	214
P	P1	■	■	■	■	■	■	■	■	■	■	■	■
	P2	■	■	■	■	■	■	■	■	■	■	■	■
	P3	■	■	■	■	■	■	■	■	■	■	■	■
	P4	■	■	■	■	■	■	■	■	■	■	■	■
M	M1	■	■	■	■	■	■	■	■	■	■	■	■
	M2	■	■	■	■	■	■	■	■	■	■	■	■
	M3												
	M4												
K	K1	■	■	■	■	■	■	■	■	■	■	■	■
	K2	■	■	■	■	■	■	■	■	■	■	■	■
	K3	■	■	■	■	■	■	■	■	■	■	■	■
	K4												
	K5	■	■	■	■	■	■	■	■	■	■	■	■
N	N1	■	■	■	■	■	■	■	■	■	■	■	■
	N2	■	■	■	■	■	■	■	■	■	■	■	■
	N3	■	■	■	■	■	■	■	■	■	■	■	■
	N4	■	■	■	■	■	■	■	■	■	■	■	■
	N5												
S	S1												
	S2												
	S3												
	S4												
H	H1												
	H2												
	H3												
	H4												

■ Primera Opción ■ Opción Alternativa



	HSS-E	HSS-E	HSS-E	HSS-E	HSS-E	HSS-E	HSS	HSS-E	HSS-E	HSS-E		HM	HSS	HSS
	Bright	Bright	Bright	Bright	Bright	Bright ST	Bright ST	Bright	Bright ST	Bright		Bright	Bright	TIN
	DIN 2179	DIN 212	DIN 212	DIN 212	DIN 208	BS 328	DIN 311	DIN 2180	DIN 219	DIN 217		DIN 335C	DIN 334C	DIN 334C
	R	R	R	R	R	R	R	R	R			R	R	R
		B	B	E	B	B		B	B					
	H7	$\begin{matrix} \phi 95-5.5 \\ +0.004 \\ \phi 5.51-12 \\ +0.005 \end{matrix}$		H7	H7	H7	k11	H7						
	1:50							1:50						
	B953	B180	B170	B157	B161	B101	B121	B954	B955	B956	B957	G400	G135	G335
	1.00 - 12.00	1.50 - 20.00	0.98 - 12.00	2.00 - 20.00	3.00 - 50.00	3.00 - 2"	10.00 - 30.00	5.00 - 30.00	25.00 - 80.00	13.00 - 40.00	N3DRIVER - N9WASHER	6.30 - 31.00	6.30 - 25.00	6.30 - 25.00
P1	■	■	■	■	■	■	■	■	■			■	■	■
P2	■	■	■	■	■	■	■	■	■			■	■	■
P3	■	■	■	■	■	■	■	■	■			■	■	■
P4	■	■	■	■	■	■	■	■	■			■	■	■
M1	■	■	■	■	■	■		■	■			■	■	■
M2	■	■	■	■	■			■	■			■	■	■
M3												■		■
M4												■		
K1	■	■	■		■	■	■	■	■			■	■	■
K2	■	■	■		■	■	■	■	■			■	■	■
K3	■	■	■		■	■	■	■	■			■	■	■
K4												■	■	■
K5												■	■	■
N1	■	■	■	■	■	■	■	■	■			■	■	■
N2	■	■	■	■	■	■	■	■	■			■	■	■
N3	■	■	■	■	■	■	■	■	■			■	■	■
N4	■	■	■		■	■	■	■	■			■	■	■
N5														
S1												■		
S2												■		
S3												■		
S4												■		
H1												■		
H2												■		
H3												■		
H4												■		



Código de Material (BMC)	HSS	HSS	HSS	HSS-E	HSS	HSS	HSS	HSS	HSS	HSS-E	HSS-E	HSS
Recubrimiento	Bright	Bright	Bright	Bright	Bright	TiAIN	Bright	TiAIN	Bright	AlTiCN	Bright	Bright
Grupo básico estándar (BSG)	DIN 334D	DIN 335C	DORMER	DORMER	DIN 335C	DIN 335C	DIN 335C	DIN 335C	DIN 335C	DIN 335C	DORMER	DORMER
Mano (dirección de corte)	R	R	R	R	R	R	R	R	R	R	R	R
Mango												
Ángulo de aplicación	60°	82°	90°	90°	90°	90°	90°	90°	90°	90°	90°	90°
Forma del Escariador												
Tolerancia del agujero alcanzable (TCHA)												
Gradiente cónico - milímetro (conicidad)												
Código de Familia de Producto	G137	G154	G129	G149	G136	G560	G106	G506	G142	G570	G107	G600
	16.00 - 80.00	6.30 - 25.00	6.00 - 31.50	5.00 - 50.00	4.30 - 31.00	6.30 - 31.00	6.30 - 50.00	6.30 - 50.00	4.80 - 31.00	6.30 - 31.00	6.30 - 20.50	6.30 - 25.00
P	P1	■	■	■	■	■	■	■	■	■	■	■
	P2	■	■	■	■	■	■	■	■	■	■	■
	P3	■	■	■	■	■	■	■	■	■	■	■
	P4	■	■	■	■	■	■	■	■	■	■	■
M	M1	■	■	■	■	■	■	■	■	■	■	■
	M2	■	■	■	■	■	■	■	■	■	■	■
	M3								■	■	■	■
	M4								■	■	■	■
K	K1	■	■	■	■	■	■	■	■	■	■	■
	K2	■	■	■	■	■	■	■	■	■	■	■
	K3	■	■	■	■	■	■	■	■	■	■	■
	K4						■	■	■	■	■	■
	K5	■	■	■	■	■	■	■	■	■	■	■
N	N1	■	■	■	■	■	■	■	■	■	■	■
	N2	■	■	■	■	■	■	■	■	■	■	■
	N3	■	■	■	■	■	■	■	■	■	■	■
	N4	■	■	■	■	■	■	■	■	■	■	■
	N5								■			
S	S1											
	S2											
	S3											
	S4											
H	H1											
	H2											
	H3											
	H4											

■ Primera Opción ■ Opción Alternativa

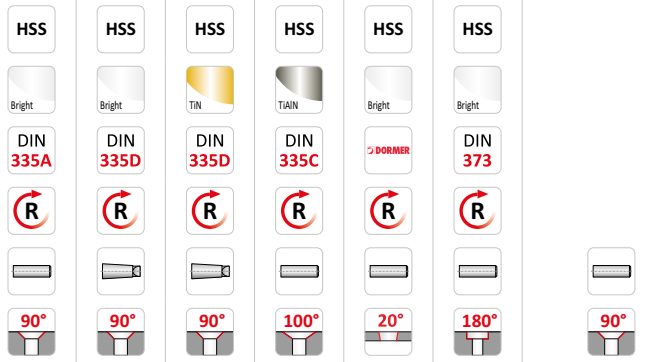

G132	G138	G338	G171	G314	G125	G236
------	------	------	------	------	------	------

8.00 - 20.00	25.00 - 80.00	25.00 - 63.00	6.30 - 25.00	4.00 - 9.00	6.50 - 20.00	Set
--------------	---------------	---------------	--------------	-------------	--------------	-----

244	245	246	247	248	249	250
-----	-----	-----	-----	-----	-----	-----

P1						
P2	■	■	■	■	■	■
P3	■	■	■	■	■	■
P4	■	■	■	■	■	■
M1		■	■	■	■	■
M2		■	■	■	■	■
M3	■					
M4	■					
K1	■	■	■	■	■	■
K2	■	■	■	■	■	■
K3	■	■	■	■	■	■
K4	■	■	■	■	■	■
K5	■	■	■	■	■	■
N1	■	■	■	■	■	■
N2	■	■	■	■	■	■
N3	■	■	■	■	■	■
N4	■	■	■	■	■	■
N5						
S1						
S2						
S3						
S4						
H1						
H2						
H3						
H4						



B400



Escariador de Máquina de Metal Duro, Espacio Desigual, con Tolerancia H7, Acabado Brillante

Diseñado para proporcionar un acabado dentro de los límites de la tolerancia H7. Para un rendimiento superior y una mayor vida útil de la herramienta al escariar materiales duros y abrasivos. El diseño helicoidal, con un espaciado extremadamente desigual entre los canales, reduce la vibración y mejora la redondez del agujero, el tamaño y el acabado superficial.

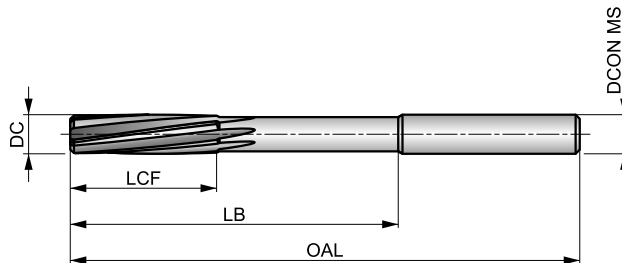

HM	Bright	DIN 8093
R		B
H7		

Grupo de Material de la pieza adecuado y condiciones de velocidad de corte iniciales (m/min) y código de avance alfabético. Tablas con avance por revolución a partir de la pag.251.

P1.1 ■ 23 B	P1.2 ■ 26 B	P1.3 ■ 27 B	P2.1 ■ 20 B	P2.2 ■ 18 B	P2.3 ■ 16 C	P3.1 ■ 16 B	P3.2 ■ 13 B	P3.3 ■ 11 C	P4.1 ■ 10 B	P4.2 ■ 8 C	P4.3 ■ 7 C	M1.1 ■ 10 C	M1.2 ■ 8 C
M2.1 ■ 19 C	M2.2 ■ 17 C	M2.3 ■ 16 B	K1.1 ■ 20 D	K1.2 ■ 15 D	K1.3 ■ 11 D	K2.1 ■ 21 D	K2.2 ■ 17 D	K2.3 ■ 14 D	K3.1 ■ 18 D	K3.2 ■ 14 D	K3.3 ■ 11 D	K5.1 ■ 19 D	K5.2 ■ 15 D
K5.3 ■ 11 D	N1.1 ■ 60 D	N1.2 ■ 45 D	N1.3 ■ 30 D	N2.1 ■ 38 D	N2.2 ■ 35 D	N2.3 ■ 25 D	N3.1 ■ 64 E	N3.2 ■ 38 E	N3.3 ■ 19 E	N4.1 ■ 35 C	N4.2 ■ 30 C		

DCON MS tolerancia h6; DC >= 14 mm con Punta de Metal Duro

Producto	DC (mm)	OAL (mm)	LCF (mm)	LB (mm)	NOF	DCON MS (mm)
B4001.0	1.00	34.0	5.5	15.00	3	1.00
B4001.2	1.20	38.0	7.5	16.50	3	1.20
B4001.4	1.40	40.0	8.0	18.00	3	1.50
B4001.5	1.50	40.0	8.0	18.00	3	1.50
B4001.6	1.60	43.0	9.0	20.00	3	1.60
B4001.8	1.80	46.0	10.0	22.00	4	1.80
B4002.0	2.00	49.0	11.0	24.00	4	2.00
B4002.2	2.20	53.0	12.0	25.00	4	2.20
B4002.5	2.50	57.0	14.0	29.00	4	2.50
B4002.8	2.80	61.0	15.0	33.00	6	3.00
B4003.0	3.00	61.0	15.0	33.00	6	3.00
B4003.2	3.20	65.0	16.0	37.00	6	3.20
B4003.5	3.50	70.0	18.0	42.00	6	3.50
B4004.0	4.00	75.0	19.0	47.00	6	4.00

Producto	DC (mm)	OAL (mm)	LCF (mm)	LB (mm)	NOF	DCON MS (mm)
B4004.5	4.50	80.0	21.0	52.00	6	4.50
B4005.0	5.00	86.0	23.0	58.00	6	5.00
B4005.5	5.50	93.0	26.0	57.00	6	5.60
B4006.0	6.00	93.0	26.0	57.00	6	5.60
B4006.5	6.50	101.0	28.0	65.00	6	6.30
B4007.0	7.00	109.0	31.0	73.00	6	7.10
B4008.0	8.00	117.0	33.0	81.00	6	8.00
B4009.0	9.00	125.0	36.0	85.00	6	9.00
B40010.0	10.00	133.0	38.0	93.00	6	10.00
B40012.0	12.00	151.0	44.0	111.00	6	10.00
B40014.0	14.00	160.0	47.0	115.00	6	12.50
B40016.0	16.00	170.0	52.0	125.00	6	12.50
B40018.0	18.00	182.0	56.0	137.00	6	14.00
B40020.0	20.00	195.0	60.0	147.00	6	16.00



B481

Escariador de Máquina de Metal Duro, Centesimal , Incrementos de 0.01 mm, Acabado Brillante

Mango recto para alto rendimiento en mecanizado CNC. Los diferentes tamaños permiten producir tolerancias de agujero precisas. Los filos de metal duro de primera calidad brindan un rendimiento muy mejorado y una mayor vida útil de la herramienta al escariar materiales duros y abrasivos. Espaciado extremadamente desigual en los canales para reducir la vibración.

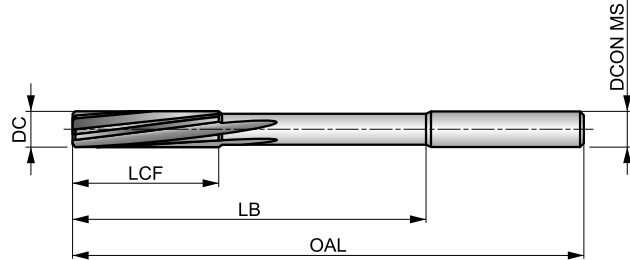

HM	Bright	DIN 8093
R	DIN 6535HA	B
$\varnothing_{.95-5.5}$ $+0.004$ $\varnothing_{5.51-12}$ $+0.005$		

Grupo de Material de la pieza adecuado y condiciones de velocidad de corte iniciales (m/min) y código de avance alfabético. Tablas con avance por revolución a partir de la pag.251.

P1.1 ■ 23 B	P1.2 ■ 26 B	P1.3 ■ 27 B	P2.1 ■ 20 B	P2.2 ■ 18 B	P2.3 ■ 16 C	P3.1 ■ 16 B	P3.2 ■ 13 B	P3.3 ■ 11 C	P4.1 ■ 10 B	P4.2 ■ 8 C	P4.3 ■ 7 C	M1.1 ■ 10 C	M1.2 ■ 8 C
M2.1 ■ 9 C	M2.2 ■ 7 C	M2.3 ■ 6 B	K1.1 ■ 20 D	K1.2 ■ 15 D	K1.3 ■ 11 D	K2.1 ■ 21 D	K2.2 ■ 17 D	K2.3 ■ 14 D	K3.1 ■ 18 D	K3.2 ■ 14 D	K3.3 ■ 11 D	K5.1 ■ 19 D	K5.2 ■ 15 D
K5.3 ■ 11 D	N1.1 ■ 60 D	N1.2 ■ 45 D	N1.3 ■ 30 D	N2.1 ■ 38 D	N2.2 ■ 35 D	N2.3 ■ 25 D	N3.1 ■ 64 E	N3.2 ■ 38 E	N3.3 ■ 19 E	N4.1 ■ 35 C	N4.2 ■ 30 C		

DCON MS tolerancia h6.

Producto	DC	OAL	LCF	LB	NOF	DCON MS
	(mm)	(mm)	(mm)	(mm)		(mm)
B4810.98	0.98	50.0	6.0	28.00	3	3.00
B4810.99	0.99	50.0	6.0	28.00	3	3.00
B4811.00	1.00	50.0	6.0	28.00	3	3.00
B4811.01	1.01	50.0	6.0	28.00	3	3.00
B4811.02	1.02	50.0	6.0	28.00	3	3.00
B4811.03	1.03	50.0	6.0	28.00	3	3.00
B4811.48	1.48	50.0	9.0	28.00	3	3.00
B4811.49	1.49	50.0	9.0	28.00	3	3.00
B4811.50	1.50	50.0	9.0	28.00	3	3.00
B4811.51	1.51	50.0	10.0	28.00	3	3.00
B4811.52	1.52	50.0	10.0	28.00	3	3.00
B4811.53	1.53	50.0	10.0	28.00	3	3.00
B4811.98	1.98	50.0	12.0	28.00	4	3.00
B4811.99	1.99	50.0	12.0	28.00	4	3.00
B4812.00	2.00	50.0	12.0	28.00	4	3.00
B4812.01	2.01	50.0	12.0	28.00	4	3.00
B4812.02	2.02	50.0	12.0	28.00	4	3.00
B4812.03	2.03	50.0	12.0	28.00	4	3.00
B4812.48	2.48	60.0	16.0	28.00	4	3.00
B4812.49	2.49	60.0	16.0	28.00	4	3.00
B4812.50	2.50	60.0	16.0	28.00	4	3.00
B4812.51	2.51	60.0	16.0	28.00	4	3.00
B4812.52	2.52	60.0	16.0	28.00	4	3.00
B4812.53	2.53	60.0	16.0	28.00	4	3.00
B4812.97	2.97	65.0	17.0	28.00	6	4.00
B4812.98	2.98	65.0	17.0	28.00	6	4.00
B4812.99	2.99	65.0	17.0	28.00	6	4.00
B4813.00	3.00	65.0	17.0	28.00	6	4.00
B4813.01	3.01	65.0	17.0	28.00	6	4.00
B4813.02	3.02	65.0	17.0	28.00	6	4.00
B4813.03	3.03	65.0	17.0	28.00	6	4.00
B4813.97	3.97	75.0	19.0	28.00	6	4.00
B4813.98	3.98	75.0	19.0	28.00	6	4.00
B4813.99	3.99	75.0	19.0	28.00	6	4.00
B4814.00	4.00	75.0	19.0	28.00	6	4.00
B4814.01	4.01	75.0	19.0	28.00	6	4.00
B4814.02	4.02	75.0	19.0	28.00	6	4.00
B4814.03	4.03	75.0	19.0	28.00	6	4.00
B4814.97	4.97	93.0	23.0	36.00	6	6.00
B4814.98	4.98	93.0	23.0	36.00	6	6.00
B4814.99	4.99	93.0	23.0	36.00	6	6.00
B4815.00	5.00	93.0	23.0	36.00	6	6.00
B4815.01	5.01	93.0	23.0	36.00	6	6.00
B4815.02	5.02	93.0	23.0	36.00	6	6.00
B4815.03	5.03	93.0	23.0	36.00	6	6.00
B4815.97	5.97	93.0	26.0	36.00	6	6.00
B4815.98	5.98	93.0	26.0	36.00	6	6.00
B4815.99	5.99	93.0	26.0	36.00	6	6.00
B4816.00	6.00	93.0	26.0	36.00	6	6.00
B4816.01	6.01	93.0	26.0	36.00	6	6.00
B4816.02	6.02	93.0	26.0	36.00	6	6.00
B4816.03	6.03	93.0	26.0	36.00	6	6.00
B4817.97	7.97	117.0	33.0	36.00	6	8.00
B4817.98	7.98	117.0	33.0	36.00	6	8.00



Producto	DC	OAL	LCF	LB	NOF	DCON MS
	(mm)	(mm)	(mm)	(mm)		(mm)
B4817.99	7.99	117.0	33.0	36.00	6	8.00
B4818.00	8.00	117.0	33.0	36.00	6	8.00
B4818.01	8.01	117.0	33.0	36.00	6	8.00
B4818.02	8.02	117.0	33.0	36.00	6	8.00
B4818.03	8.03	117.0	33.0	36.00	6	8.00
B4818.04	8.04	117.0	33.0	36.00	6	8.00
B4819.97	9.97	133.0	38.0	40.00	6	10.00
B4819.98	9.98	133.0	38.0	40.00	6	10.00
B4819.99	9.99	133.0	38.0	40.00	6	10.00
B48110.00	10.00	133.0	38.0	40.00	6	10.00
B48110.01	10.01	133.0	38.0	40.00	6	10.00
B48110.02	10.02	133.0	38.0	40.00	6	10.00

Producto	DC	OAL	LCF	LB	NOF	DCON MS
	(mm)	(mm)	(mm)	(mm)		(mm)
B48110.03	10.03	133.0	38.0	40.00	6	10.00
B48110.04	10.04	133.0	38.0	40.00	6	10.00
B48110.05	10.05	133.0	38.0	40.00	6	10.00
B48111.97	11.97	151.0	44.0	45.00	6	12.00
B48111.98	11.98	151.0	44.0	45.00	6	12.00
B48111.99	11.99	151.0	44.0	45.00	6	12.00
B48112.00	12.00	151.0	44.0	45.00	6	12.00
B48112.01	12.01	151.0	44.0	45.00	6	12.00
B48112.02	12.02	151.0	44.0	45.00	6	12.00
B48112.03	12.03	151.0	44.0	45.00	6	12.00
B48112.04	12.04	151.0	44.0	45.00	6	12.00
B48112.05	12.05	151.0	44.0	45.00	6	12.00



B441



Escariador de Máquina con Punta de Metal Duro, Mango Cilíndrico, Tolerancia H7, Acabado Brillante

La cabeza de metal duro soldada prolongará la vida útil de la herramienta y ofrecerá un rendimiento superior al escariar agujeros dentro de los límites de la tolerancia H7. El diseño extremadamente desigual de los canales reduce vibraciones y mejora la redondez del agujero, el acabado superficial y el tamaño. Esta herramienta ofrece un gran rendimiento en máquinas CNC.

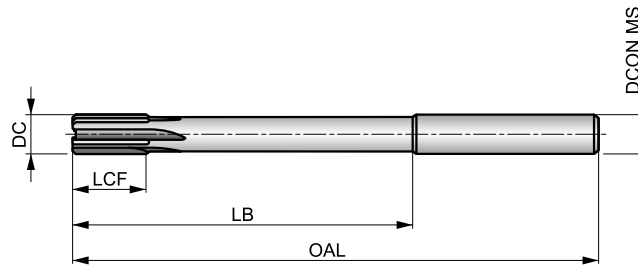

HM	Bright	DIN 8050
R		A
H7		

Grupo de Material de la pieza adecuado y condiciones de velocidad de corte iniciales (m/min) y código de avance alfabético. Tablas con avance por revolución a partir de la pag.251.

P1.1 ■ 23 B	P1.2 ■ 26 B	P1.3 ■ 27 B	P2.1 ■ 20 B	P2.2 ■ 18 B	P2.3 ■ 16 C	P3.1 ■ 16 B	P3.2 ■ 13 B	P3.3 ■ 11 C	P4.1 ■ 10 B	P4.2 ■ 8 C	P4.3 ■ 7 C	M1.1 ▣ 10 C	M1.2 ▣ 8 C
M2.1 ▣ 9 C	M2.2 ▣ 7 C	M2.3 ▣ 6 B	K1.1 ■ 20 D	K1.2 ■ 15 D	K1.3 ■ 11 D	K2.1 ■ 21 D	K2.2 ■ 17 D	K2.3 ■ 14 D	K3.1 ■ 18 D	K3.2 ■ 14 D	K3.3 ■ 11 D	K5.1 ■ 19 D	K5.2 ■ 15 D
K5.3 ■ 11 D	N1.1 ▣ 60 D	N1.2 ■ 45 D	N1.3 ■ 30 D	N2.1 ■ 38 D	N2.2 ■ 35 D	N2.3 ■ 25 D	N3.1 ■ 64 E	N3.2 ■ 38 E	N3.3 ▣ 19 E	N4.1 ▣ 35 C	N4.2 ▣ 30 C		

DCON MS tolerancia h9; con Punta de Metal Duro

Producto	DC (mm)	OAL (mm)	LCF (mm)	LB (mm)	NOF	DCON MS (mm)
B44110.0	10.00	133.0	19.0	87.00	6	10.00
B44111.0	11.00	142.0	19.0	96.00	6	10.00
B44112.0	12.00	151.0	19.0	105.00	6	10.00
B44113.0	13.00	151.0	19.0	105.00	6	10.00
B44114.0	14.00	160.0	19.0	110.00	6	12.50
B44115.0	15.00	162.0	19.0	112.00	6	12.50
B44116.0	16.00	170.0	22.0	120.00	6	12.50
B44117.0	17.00	175.0	22.0	123.00	6	14.00
B44118.0	18.00	182.0	22.0	130.00	6	14.00
B44119.0	19.00	189.0	22.0	131.00	6	16.00
B44120.0	20.00	195.0	22.0	137.00	6	16.00



B411



Escariador de Máquina con Punta de Metal Duro, Mango Cónico, Tolerancia H7, Acabado Brillante

La cabeza de metal duro soldada ofrece mejoras significativas en el rendimiento y una vida útil más prolongada de la herramienta al escariar materiales duros y abrasivos. Los canales helicoidales tienen un espaciado desigual entre ellos, lo que reduce eficientemente las vibraciones y mejora la simetría, el tamaño y el acabado del agujero.

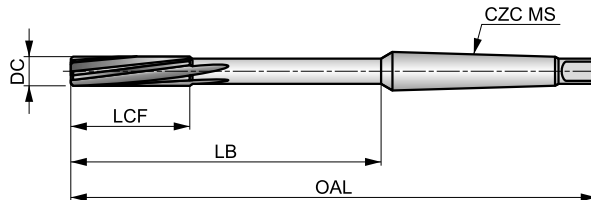

HM	Bright	DIN 8094
R		B
H7		

Grupo de Material de la pieza adecuado y condiciones de velocidad de corte iniciales (m/min) y código de avance alfabético. Tablas con avance por revolución a partir de la pag.251.

P1.1 ■ 23 B	P1.2 ■ 26 B	P1.3 ■ 27 B	P2.1 ■ 20 B	P2.2 ■ 18 B	P2.3 ■ 16 C	P3.1 ■ 16 B	P3.2 ■ 13 B	P3.3 ■ 11 C	P4.1 ■ 10 B	P4.2 ■ 8 C	P4.3 ■ 7 C	M1.1 ■ 10 C	M1.2 ■ 8 C
M2.1 ■ 19 C	M2.2 ■ 17 C	M2.3 ■ 16 B	K1.1 ■ 20 D	K1.2 ■ 15 D	K1.3 ■ 11 D	K2.1 ■ 21 D	K2.2 ■ 17 D	K2.3 ■ 14 D	K3.1 ■ 18 D	K3.2 ■ 14 D	K3.3 ■ 11 D	K5.1 ■ 19 D	K5.2 ■ 15 D
K5.3 ■ 11 D	N1.1 ■ 60 D	N1.2 ■ 45 D	N1.3 ■ 30 D	N2.1 ■ 38 D	N2.2 ■ 35 D	N2.3 ■ 25 D	N3.1 ■ 64 E	N3.2 ■ 38 E	N3.3 ■ 19 E	N4.1 ■ 35 C	N4.2 ■ 30 C		

DC <= 16mm Cabeza de Metal Duro; DC > 16mm con Punta de Metal Duro

Producto	DC (mm)	OAL (mm)	LCF (mm)	LB (mm)	NOF	CZC MS
B4115.0	5.00	133.0	23.0	67.50	6	MK 1
B4116.0	6.00	138.0	26.0	72.50	6	MK 1
B4117.0	7.00	150.0	31.0	84.50	6	MK 1
B4118.0	8.00	156.0	33.0	90.50	6	MK 1
B4119.0	9.00	162.0	36.0	96.50	6	MK 1
B41110.0	10.00	168.0	38.0	102.50	6	MK 1
B41112.0	12.00	182.0	44.0	116.50	6	MK 1
B41114.0	14.00	189.0	47.0	123.50	8	MK 1
B41115.0	15.00	204.0	50.0	124.00	8	MK 2
B41116.0	16.00	210.0	52.0	130.00	8	MK 2
B41117.0	17.00	214.0	54.0	134.00	6	MK 2
B41118.0	18.00	219.0	56.0	139.00	6	MK 2
B41119.0	19.00	223.0	58.0	143.00	6	MK 2
B41120.0	20.00	228.0	60.0	148.00	6	MK 2
B41122.0	22.00	237.0	64.0	157.00	6	MK 2
B41124.0	24.00	268.0	68.0	169.00	8	MK 3
B41125.0	25.00	268.0	68.0	169.00	8	MK 3
B41126.0	26.00	273.0	70.0	174.00	8	MK 3
B41130.0	30.00	281.0	73.0	182.00	8	MK 3



B442



Escariador de Máquina, Metal Duro, Mango Cónico, Espacio Desigual, Tolerancia H7, Acabado Brillante

Diseñado con canales extremadamente desiguales para reducir la vibración y mejorar el tamaño del agujero, la redondez y el acabado superficial. El chaflán de entrada a 45 ° garantiza una ubicación y un centrado precisos para brindarle un mejor rendimiento y calidad de agujero. La punta de metal duro soldada proporciona una mayor vida útil de la herramienta y un rendimiento superior.

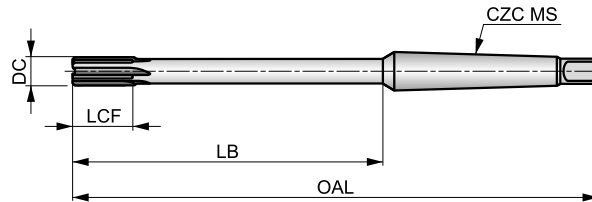

HM	Bright	DIN 8051
R		A
H7		

Grupo de Material de la pieza adecuado y condiciones de velocidad de corte iniciales (m/min) y código de avance alfabético. Tablas con avance por revolución a partir de la pag.251.

P1.1 ■ 23 B	P1.2 ■ 26 B	P1.3 ■ 27 B	P2.1 ■ 20 B	P2.2 ■ 18 B	P2.3 ■ 16 C	P3.1 ■ 16 B	P3.2 ■ 13 B	P3.3 ■ 11 C	P4.1 ■ 10 B	P4.2 ■ 8 C	P4.3 ■ 7 C	M1.1 ▣ 10 C	M1.2 ▣ 8 C
M2.1 ▣ 9 C	M2.2 ▣ 7 C	M2.3 ▣ 6 B	K1.1 ■ 20 D	K1.2 ■ 15 D	K1.3 ■ 11 D	K2.1 ■ 21 D	K2.2 ■ 17 D	K2.3 ■ 14 D	K3.1 ■ 18 D	K3.2 ■ 14 D	K3.3 ■ 11 D	K5.1 ■ 19 D	K5.2 ■ 15 D
K5.3 ■ 11 D	N1.1 ▣ 60 D	N1.2 ■ 45 D	N1.3 ■ 30 D	N2.1 ■ 38 D	N2.2 ■ 35 D	N2.3 ■ 25 D	N3.1 ■ 64 E	N3.2 ■ 38 E	N3.3 ▣ 19 E	N4.1 ▣ 35 C	N4.2 ▣ 30 C		

Producto	DC (mm)	OAL (mm)	LCF (mm)	LB (mm)	NOF	CZC MS
B44210.0	10.00	168.0	19.0	102.50	6	MK 1
B44212.0	12.00	182.0	19.0	116.50	6	MK 1
B44214.0	14.00	189.0	19.0	123.50	6	MK 1
B44215.0	15.00	204.0	19.0	124.00	6	MK 2
B44216.0	16.00	210.0	22.0	130.00	6	MK 2
B44217.0	17.00	214.0	22.0	134.00	6	MK 2
B44218.0	18.00	219.0	22.0	139.00	6	MK 2
B44219.0	19.00	223.0	22.0	143.00	6	MK 2
B44220.0	20.00	228.0	22.0	148.00	6	MK 2



B100



Escariador HSS, Mango Cilíndrico, Tolerancia H7, Acabado Brillante/Templado al Vapor

Diseñado principalmente para escariar a mano. Tiene una hélice izquierda rectificada con precisión y corte a derecha (en el sentido de las agujas del reloj) para un escariado suave, creando un agujero más preciso y un buen acabado superficial. Adecuado para escariar muchos materiales, incluidos aceros.

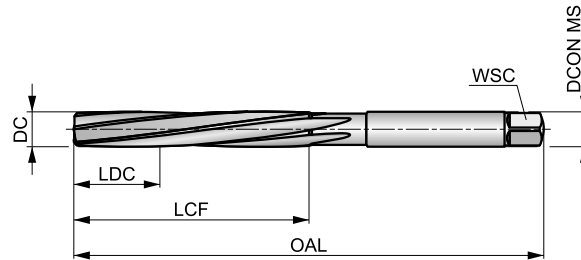

HSS	Bright ST	DIN 206
R		B
H7		

Grupo de Material de la pieza adecuado y condiciones de velocidad de corte iniciales (m/min) y código de avance alfabético. Tablas con avance por revolución a partir de la pag.251.

P1.1	P1.2	P1.3	P2.1	P2.2	P2.3	P3.1	P3.2	P3.3	P4.1	P4.2	P4.3	M1.1	M1.2
■	■	■	■	■	■	■	■	■	■	■	■	■	■
M2.1	K1.1	K1.2	K1.3	K2.1	K2.2	K2.3	K3.1	K3.2	N1.1	N1.2	N1.3	N2.1	N2.2
■	■	■	■	■	■	■	■	■	■	■	■	■	■
N2.3	N3.1	N3.2	N3.3	N4.1	N4.2								
■	■	■	■	■	■								

DCON MS tolerancia e9.

Producto	DC (inch)	DC (mm)	OAL (mm)	LCF (mm)	LDC (mm)	NOF	WSC (mm)	DCON MS (mm)
B1001.5	-	1.50	41.0	20.0	5.00	3	1.12	1.50
B1001/16	1/16	1.59	41.0	20.0	5.00	3	1.12	1.59
B1001.6	-	1.60	44.0	21.0	5.00	3	1.25	1.60
B1005/64	5/64	1.98	47.0	23.0	6.00	4	1.40	1.98
B1002.0	-	2.00	50.0	25.0	6.00	4	1.60	2.00
B1003/32	3/32	2.38	54.0	27.0	7.00	4	1.80	2.38
B1002.5	-	2.50	58.0	29.0	7.00	4	2.10	2.50
B1007/64	7/64	2.78	62.0	31.0	8.00	6	2.10	2.78
B1003.0	-	3.00	62.0	31.0	8.00	6	2.40	3.00
B1001/8	1/8	3.18	66.0	33.0	8.00	6	2.40	3.18
B1003.2	-	3.20	66.0	33.0	8.00	6	2.40	3.20
B1003.5	-	3.50	71.0	35.0	9.00	6	2.70	3.50
B1009/64	9/64	3.57	71.0	35.0	9.00	6	2.70	3.57
B1005/32	5/32	3.97	76.0	38.0	10.00	6	3.00	3.97
B1004.0	-	4.00	76.0	38.0	10.00	6	3.00	4.00
B10011/64	11/64	4.37	81.0	41.0	10.00	6	3.40	4.37
B1004.5	-	4.50	81.0	41.0	10.00	6	3.40	4.50
B1003/16	3/16	4.76	87.0	44.0	11.00	6	3.80	4.76
B1005.0	-	5.00	87.0	44.0	11.00	6	3.80	5.00
B10013/64	13/64	5.16	87.0	44.0	11.00	6	3.80	5.16
B1005.5	-	5.50	93.0	47.0	12.00	6	4.30	5.50
B1007/32	7/32	5.56	93.0	47.0	12.00	6	4.30	5.56
B10015/64	15/64	5.95	93.0	47.0	12.00	6	4.90	5.95
B1006.0	-	6.00	93.0	47.0	12.00	6	4.90	6.00
B1001/4	1/4	6.35	100.0	50.0	13.00	6	4.90	6.35
B1006.5	-	6.50	100.0	50.0	13.00	6	4.90	6.50
B10017/64	17/64	6.75	107.0	54.0	14.00	6	5.50	6.75



Producto	DC	DC	OAL	LCF	LDC	NOF	WSC	DCON MS
	(inch)	(mm)	(mm)	(mm)	(mm)		(mm)	(mm)
B1007.0	–	7.00	107.0	54.0	14.00	6	5.50	7.00
B1009/32	9/32	7.14	107.0	54.0	14.00	6	6.20	7.14
B1007.5	–	7.50	107.0	54.0	14.00	6	6.20	7.50
B10019/64	19/64	7.54	115.0	58.0	15.00	6	6.20	7.54
B1005/16	5/16	7.94	115.0	58.0	15.00	6	6.20	7.94
B1008.0	–	8.00	115.0	58.0	15.00	6	6.20	8.00
B10021/64	21/64	8.33	115.0	58.0	15.00	6	7.00	8.33
B1008.5	–	8.50	115.0	58.0	15.00	6	7.00	8.50
B10011/32	11/32	8.73	124.0	62.0	16.00	6	7.00	8.73
B1009.0	–	9.00	124.0	62.0	16.00	6	7.00	9.00
B10023/64	23/64	9.13	124.0	62.0	16.00	6	8.00	9.13
B1009.5	–	9.50	124.0	62.0	16.00	6	8.00	9.50
B1003/8	3/8	9.52	124.0	62.0	17.00	6	8.00	9.52
B10025/64	25/64	9.92	133.0	66.0	17.00	6	8.00	9.92
B10010.0	–	10.00	133.0	66.0	17.00	6	8.00	10.00
B10013/32	13/32	10.32	133.0	66.0	17.00	6	8.00	10.32
B10010.5	–	10.50	133.0	66.0	17.00	6	8.00	10.50
B10011.0	–	11.00	142.0	71.0	18.00	6	9.00	11.00
B1007/16	7/16	11.11	142.0	71.0	18.00	6	9.00	11.11
B10011.5	–	11.50	142.0	71.0	18.00	6	9.00	11.50
B10012.0	–	12.00	152.0	76.0	19.00	6	9.00	12.00
B10012.5	–	12.50	152.0	76.0	19.00	6	10.00	12.50
B1001/2	1/2	12.70	152.0	76.0	19.00	6	10.00	12.70
B10013.0	–	13.00	152.0	76.0	19.00	6	10.00	13.00
B10017/32	17/32	13.49	163.0	81.0	20.00	8	11.00	13.49
B10013.5	–	13.50	163.0	81.0	20.00	8	11.00	13.50
B10014.0	–	14.00	163.0	81.0	20.00	8	11.00	14.00
B1009/16	9/16	14.29	163.0	81.0	20.00	8	11.00	14.29
B10014.5	–	14.50	163.0	81.0	20.00	8	11.00	14.50
B10015.0	–	15.00	163.0	81.0	20.00	8	12.00	15.00
B10019/32	19/32	15.08	163.0	81.0	22.00	8	12.00	15.08
B1005/8	5/8	15.88	175.0	87.0	22.00	8	12.00	15.88
B10016.0	–	16.00	175.0	87.0	22.00	8	12.00	16.00
B10017.0	–	17.00	175.0	87.0	22.00	8	13.00	17.00
B10011/16	11/16	17.46	188.0	93.0	23.00	8	14.50	17.46
B10018.0	–	18.00	188.0	93.0	23.00	8	14.50	18.00
B10019.0	–	19.00	188.0	93.0	23.00	8	14.50	19.00
B1003/4	3/4	19.05	188.0	93.0	25.00	8	14.50	19.05
B10020.0	–	20.00	201.0	100.0	25.00	8	16.00	20.00
B10013/16	13/16	20.64	201.0	100.0	25.00	8	16.00	20.64
B10021.0	–	21.00	201.0	100.0	25.00	8	16.00	21.00
B10022.0	–	22.00	215.0	107.0	27.00	8	18.00	22.00
B1007/8	7/8	22.22	215.0	107.0	27.00	8	18.00	22.22
B10023.0	–	23.00	215.0	107.0	27.00	8	18.00	23.00
B10024.0	–	24.00	231.0	115.0	29.00	8	18.00	24.00
B10025.0	–	25.00	231.0	115.0	29.00	8	20.00	25.00
B1001	1"	25.40	231.0	115.0	29.00	8	20.00	25.40
B10026.0	–	26.00	231.0	115.0	29.00	8	20.00	26.00
B10027.0	–	27.00	247.0	124.0	31.00	10	22.00	27.00
B10028.0	–	28.00	247.0	124.0	31.00	10	22.00	28.00
B10029.0	–	29.00	247.0	124.0	31.00	10	22.00	29.00
B10030.0	–	30.00	247.0	124.0	31.00	10	24.00	30.00
B10031.0	–	31.00	265.0	133.0	33.00	10	24.00	31.00
B10032.0	–	32.00	265.0	133.0	33.00	10	24.00	32.00
B10033.0	–	33.00	265.0	133.0	33.00	10	26.00	33.00
B10034.0	–	34.00	284.0	142.0	36.00	10	26.00	34.00
B10035.0	–	35.00	284.0	142.0	36.00	10	29.00	35.00
B10036.0	–	36.00	284.0	142.0	36.00	10	29.00	36.00
B10037.0	–	37.00	284.0	142.0	36.00	10	29.00	37.00
B10038.0	–	38.00	305.0	152.0	38.00	10	29.00	38.00
B10039.0	–	39.00	305.0	152.0	38.00	10	32.00	39.00
B10040.0	–	40.00	305.0	152.0	38.00	10	32.00	40.00
B10045.0	–	45.00	326.0	163.0	41.00	12	35.00	45.00
B10050.0	–	50.00	347.0	174.0	44.00	12	39.00	50.00



B334



Escariador HSS de Mano, Ajustable, Mango Cilíndrico

Este escariador de mano es fácilmente ajustable, lo que hace posible terminar agujeros de diferentes diámetros con un solo escariador. Con cuchillas rectificadas de precisión y geometría recta se logra un escariado suave, un tamaño de agujero preciso y un acabado superficial mejorado. Adecuado para escariar en la mayoría de materiales.

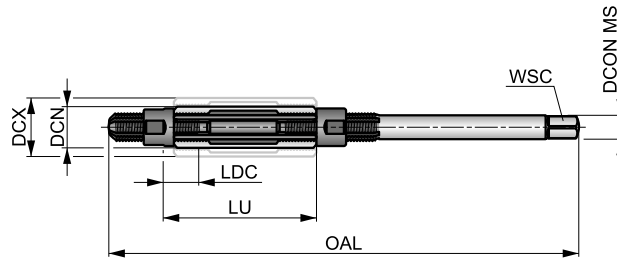

HSS	Bright	DORMER
R		

Grupo de Material de la pieza adecuado y condiciones de velocidad de corte iniciales (m/min) y código de avance alfabético. Tablas con avance por revolución a partir de la pag.251.

P1.1	P1.2	P1.3	P2.1	P2.2	P2.3	P3.1	P3.2	P3.3	P4.1	P4.2	P4.3	M1.1	M1.2
■	■	■	■	■	■	■	■	■	■	■	■	■	■
M2.1	K1.1	K1.2	K1.3	K2.1	K2.2	K2.3	K3.1	K3.2	N1.1	N1.2	N1.3	N2.1	N2.2
■	■	■	■	■	■	■	■	■	■	■	■	■	■
N2.3	N3.1	N3.2	N3.3	N4.1	N4.2								
■	■	■	■	■	■								

Producto	Nr.	DCN	DCX	OAL	LU	LDC	NOF	WSC
		(mm)	(mm)	(mm)	(mm)	(mm)		(mm)
B334000	000	6.40	7.20	110.0	32.00	7.00	4	3.00
B33400	00	7.20	8.00	110.0	32.00	7.00	4	3.40
B3340	0	8.00	9.00	115.0	34.00	9.00	5	3.80
B3341	1	9.00	10.00	115.0	34.00	9.00	5	4.30
B3342	2	10.00	11.00	115.0	34.00	9.00	5	4.90
B3343	3	11.00	12.00	125.0	35.00	9.00	5	4.90
B3344	4	12.00	13.50	135.0	41.00	9.00	5	6.20
B3345	5	13.50	15.50	146.0	50.00	12.00	5	7.00
B3346	6	15.50	18.00	166.0	60.00	12.00	5	8.00
B3347	7	18.00	21.00	178.0	65.00	15.00	5	9.00
B3348	8	21.00	24.00	195.0	76.00	15.00	5	11.00
B3349	9	24.00	27.50	218.0	82.00	18.00	5	12.00
B33410	10	27.50	31.50	245.0	86.00	18.00	5	14.50
B33411	11	31.50	37.00	280.0	98.00	18.00	6	18.00
B33412	12	37.00	45.00	325.0	108.00	20.00	6	20.00
B33413	13	45.00	55.00	370.0	118.00	20.00	6	26.00
B33414	14	55.00	67.00	400.0	125.00	20.00	6	32.00
B33415	15	67.00	80.00	435.0	140.00	23.00	8	39.00
B33416	16	80.00	95.00	475.0	155.00	23.00	8	49.00



B335



Accesorios para Portaescariador B334 (Cuchillas y Tuercas)

La tuerca y las cuchillas se pueden comprar por separado y cada una está disponible en 19 tamaños.

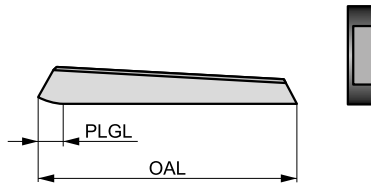

Producto	Nr.	PLGL	OAL
		(mm)	(mm)
B335000BLADES	000	7.00	32.0
B335000NUT	000	—	—
B33500BLADES	00	7.00	32.0
B33500NUT	00	—	—
B3350BLADES	0	9.00	34.0
B3350NUT	0	—	—
B3351BLADES	1	9.00	34.0
B3351NUT	1	—	—
B3352BLADES	2	9.00	34.0
B3352NUT	2	—	—
B3353BLADES	3	9.00	35.0
B3353NUT	3	—	—
B3354BLADES	4	9.00	41.0
B3354NUT	4	—	—
B3355BLADES	5	12.00	50.0
B3355NUT	5	—	—
B3356BLADES	6	12.00	60.0
B3356NUT	6	—	—
B3357BLADES	7	15.00	65.0

Producto	Nr.	PLGL	OAL
		(mm)	(mm)
B3357NUT	7	—	—
B3358BLADES	8	15.00	76.0
B3358NUT	8	—	—
B3359BLADES	9	18.00	82.0
B3359NUT	9	—	—
B33510BLADES	10	18.00	86.0
B33510NUT	10	—	—
B33511BLADES	11	18.00	98.0
B33511NUT	11	—	—
B33512BLADES	12	20.00	108.0
B33512NUT	12	—	—
B33513BLADES	13	20.00	118.0
B33513NUT	13	—	—
B33514BLADES	14	20.00	125.0
B33514NUT	14	—	—
B33515BLADES	15	23.00	140.0
B33515NUT	15	—	—
B33516BLADES	16	23.00	155.0
B33516NUT	16	—	—



B901



Escariador de Máquina HSS-E, Mango Cilíndrico, Tolerancia H7, Acabado Brillante/Templado al Vapor

La geometría rectificada de precisión, con hélice a izquierda y acción de corte a derecha, mejora el acabado superficial y el tamaño del agujero. El escariador tiene mango recto para conseguir un escariado de alto rendimiento en máquinas. Adecuado para escariar en muchos materiales.

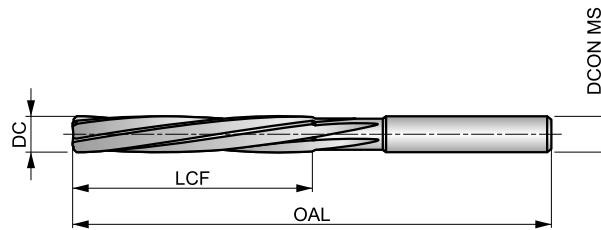

HSS-E	Bright ST	BS 328
R		B
H7		

Grupo de Material de la pieza adecuado y condiciones de velocidad de corte iniciales (m/min) y código de avance alfabético. Tablas con avance por revolución a partir de la pag.251.

P1.1 ■ 15 C	P1.2 ■ 16 C	P1.3 ■ 17 C	P2.1 ■ 13 C	P2.2 ■ 11 C	P2.3 ▧ 10 B	P3.1 ■ 7 B	P3.2 ■ 6 B	P3.3 ▧ 5 B	P4.1 ■ 4 B	P4.2 ▧ 4 B	P4.3 ▧ 3 A	M1.1 ▧ 10 C	M1.2 ▧ 8 C
M2.1 ▧ 9 C	K1.1 ■ 14 E	K1.2 ■ 10 D	K1.3 ▧ 8 D	K2.1 ■ 12 C	K2.2 ■ 10 C	K2.3 ▧ 8 C	K3.1 ▧ 11 C	K3.2 ▧ 8 C	N1.1 ▧ 23 F	N1.2 ■ 17 F	N1.3 ■ 12 F	N2.1 ■ 25 E	N2.2 ■ 22 E
N2.3 ▧ 14 E	N3.1 ■ 34 D	N3.2 ■ 20 E	N3.3 ■ 10 D	N4.1 ▧ 22 B	N4.2 ▧ 21 B								

Producto	DC (inch)	DC (mm)	OAL (mm)	LCF (mm)	NOF	DCON MS (mm)
B9011.5	—	1.50	44.0	21.0	4	1.50
B9011/16	1/16	1.59	44.0	21.0	4	1.59
B9012.0	—	2.00	50.0	25.0	4	2.00
B9013/32	3/32	2.38	58.0	29.0	4	2.38
B9012.5	—	2.50	58.0	29.0	4	2.50
B9013.0	—	3.00	62.0	31.0	4	3.00
B9011/8	1/8	3.18	66.0	33.0	4	3.18
B9013.5	—	3.50	71.0	35.0	4	3.50
B9015/32	5/32	3.97	76.0	38.0	6	3.97
B9014.0	—	4.00	76.0	38.0	6	4.00
B9014.5	—	4.50	81.0	41.0	6	4.50
B9013/16	3/16	4.76	87.0	44.0	6	4.76
B9015.0	—	5.00	87.0	44.0	6	5.00
B90113/64	13/64	5.16	87.0	44.0	6	5.16
B9015.5	—	5.50	93.0	47.0	6	5.50

Producto	DC (inch)	DC (mm)	OAL (mm)	LCF (mm)	NOF	DCON MS (mm)
B9017/32	7/32	5.56	93.0	47.0	6	5.56
B90115/64	15/64	5.95	93.0	47.0	6	5.95
B9016.0	—	6.00	93.0	47.0	6	6.00
B9011/4	1/4	6.35	100.0	50.0	6	6.35
B9017.0	—	7.00	107.0	54.0	6	7.00
B9019/32	9/32	7.14	107.0	54.0	6	7.14
B9015/16	5/16	7.94	115.0	58.0	6	7.94
B9018.0	—	8.00	115.0	58.0	6	8.00
B9019.0	—	9.00	124.0	62.0	6	9.00
B9013/8	3/8	9.52	133.0	66.0	6	9.52
B90110.0	—	10.00	133.0	66.0	6	10.00
B90111.0	—	11.00	142.0	71.0	6	11.00
B9017/16	7/16	11.11	142.0	71.0	6	11.11
B90112.0	—	12.00	152.0	76.0	6	12.00
B9011/2	1/2	12.70	152.0	76.0	6	12.70



B301



Escariador de Mano HSS para Pasadores Cónicos, Conicidad 1:48, Templado al Vapor y Acabado Brillante
 Diseñado para acabado de agujeros cónicos para pasadores cónicos imperiales de proporción estándar 1 a 48. Con un diámetro pequeño reducido, la herramienta se ubica y centra fácilmente en el agujero pretaladrado para mejorar la precisión y el rendimiento. Adecuado para escariado en muchos materiales.

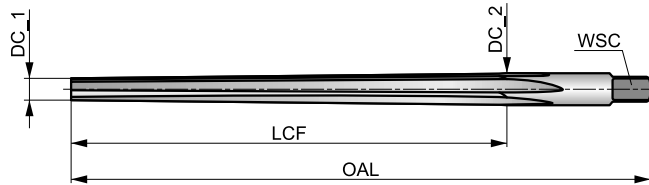

HSS	Bright ST	BS 328
R		A
1:48		

Grupo de Material de la pieza adecuado y condiciones de velocidad de corte iniciales (m/min) y código de avance alfabético. Tablas con avance por revolución a partir de la pag.251.

P1.1	P1.2	P1.3	P2.1	P2.2	P2.3	P3.1	P3.2	P3.3	P4.1	P4.2	P4.3	M1.1	M1.2
■	■	■	■	■	■	■	■	■	■	■	■	■	■
M2.1	K1.1	K1.2	K1.3	K2.1	K2.2	K2.3	K3.1	K3.2	N1.1	N1.2	N1.3	N2.1	N2.2
■	■	■	■	■	■	■	■	■	■	■	■	■	■
N2.3	N3.1	N3.2	N3.3	N4.1	N4.2								
■	■	■	■	■	■								

DC <= 1/4 límite de tolerancia +0.0030; DC >= 9/32 límite de tolerancia +0.0050.

Producto	nom d	DC_1	DC_2	OAL	LCF	NOF	WSC	DCON MS
		(mm)	(mm)	(mm)	(mm)		(mm)	(mm)
B3011/16	1/16	1.10	1.63	51.0	25.0	4	1.20	1.63
B3015/64	5/64	1.50	2.03	51.0	25.0	4	1.60	2.03
B3013/32	3/32	1.75	2.41	57.0	32.0	4	2.00	2.41
B3017/64	7/64	2.03	2.82	64.0	38.0	4	2.20	2.82
B3011/8	1/8	2.30	3.23	70.0	44.0	4	2.50	3.23
B3019/64	9/64	2.64	3.63	73.0	48.0	4	2.80	3.63
B3015/32	5/32	2.95	4.01	76.0	51.0	4	3.10	4.01
B30111/64	11/64	3.23	4.42	89.0	57.0	4	3.60	4.42
B3013/16	3/16	3.50	4.95	102.0	70.0	4	4.00	4.95
B3017/32	7/32	4.13	5.59	102.0	70.0	6	4.50	5.59
B3011/4	1/4	4.64	6.43	117.0	86.0	6	5.00	6.43
B3019/32	9/32	5.23	7.42	143.0	105.0	6	5.60	7.42
B3015/16	5/16	5.84	8.03	143.0	105.0	6	6.30	8.03
B30111/32	11/32	6.43	8.81	152.0	114.0	6	7.10	8.81
B3013/8	3/8	7.03	9.68	165.0	127.0	6	8.00	9.68
B30113/32	13/32	7.42	10.46	191.0	146.0	6	8.00	10.46
B3017/16	7/16	8.21	11.25	191.0	146.0	6	9.00	11.25
B3011/2	1/2	9.41	12.85	210.0	165.0	6	10.00	12.85



B903



Escariador de Mano HSS para Pasadores Cónicos, Conicidad 1:50, Templado al Vapor y Acabado Brillante
 Diseñado para acabado de agujeros cónicos para pasadores cónicos métricos de proporción estándar 1 a 50. El diámetro del extremo es reducido para que sea más fácil ubicar y centrar el escariador en el agujero. Adecuado para escariado en muchos materiales.

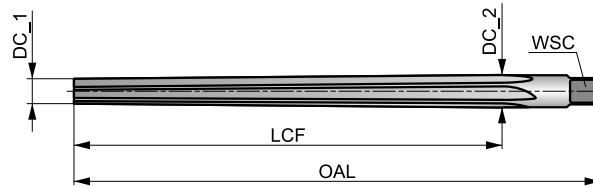

HSS	Bright ST	DIN 9
R		A
1:50		

Grupo de Material de la pieza adecuado y condiciones de velocidad de corte iniciales (m/min) y código de avance alfabético. Tablas con avance por revolución a partir de la pag.251.

P1.1	P1.2	P1.3	P2.1	P2.2	P2.3	P3.1	P3.2	P3.3	P4.1	P4.2	P4.3	M1.1	M1.2
■	■	■	■	■	■	■	■	■	■	■	■	■	■
M2.1	K1.1	K1.2	K1.3	K2.1	K2.2	K2.3	K3.1	K3.2	N1.1	N1.2	N1.3	N2.1	N2.2
■	■	■	■	■	■	■	■	■	■	■	■	■	■
N2.3	N3.1	N3.2	N3.3	N4.1	N4.2								
■	■	■	■	■	■								

DCON MS tolerancia h11; DC <= 5mm límite de tolerancia +0.0750; DC < 5mm límite de tolerancia +0.1250.

Producto	nom d	DC_1	DC_2	OAL	LCF	NOF	WSC	DCON MS
		(mm)	(mm)	(mm)	(mm)		(mm)	(mm)
B9031.5	1.5	1.40	2.14	57.0	37.0	4	1.80	2.14
B9032.0	2.0	1.90	2.86	68.0	48.0	4	2.24	2.86
B9032.5	2.5	2.40	3.36	68.0	48.0	4	2.80	3.36
B9033.0	3.0	2.90	4.06	80.0	58.0	4	3.15	4.00
B9034.0	4.0	3.90	5.26	93.0	68.0	4	4.00	5.00
B9035.0	5.0	4.90	6.36	100.0	73.0	4	5.00	6.30
B9036.0	6.0	5.90	8.00	135.0	105.0	6	6.30	7.90
B9038.0	8.0	7.90	10.80	180.0	145.0	6	8.00	10.50
B90310.0	10.0	9.90	13.40	215.0	175.0	6	10.00	13.30
B90312.0	12.0	11.80	16.00	255.0	210.0	8	11.20	16.00
B90313.0	13.0	12.86	16.74	255.0	210.0	8	12.50	16.74
B90314.0	14.0	13.86	17.74	255.0	210.0	8	12.50	17.74
B90316.0	16.0	15.80	20.40	280.0	230.0	8	14.00	20.40
B90320.0	20.0	19.80	24.80	310.0	250.0	8	18.00	24.80



B952

DORMER

Escariador de Máquina HSS-E para Pasadores Cónicos, Conicidad 1:50, Mango Cilíndrico

Con corte a derecha y a izquierda, proporciona un escariado suave para un tamaño de agujero más preciso y un mejor acabado. Se ha reducido el diámetro de la punta, lo que facilita la ubicación y el centrado del escariador en el agujero. Adecuado para escariar en muchos materiales.

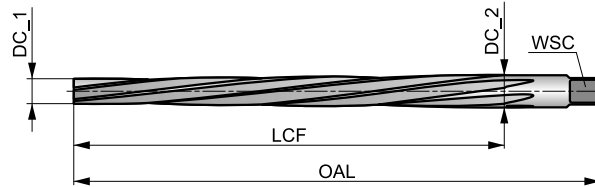

HSS	Bright	DIN 9
R		B
1:50		

Grupo de Material de la pieza adecuado y condiciones de velocidad de corte iniciales (m/min) y código de avance alfabético. Tablas con avance por revolución a partir de la pag.251.

P1.1	P1.2	P1.3	P2.1	P2.2	P2.3	P3.1	P3.2	P3.3	P4.1	P4.2	P4.3	M1.1	M1.2
■	■	■	■	■	■	■	■	■	■	■	■	■	■
M2.1	K1.1	K1.2	K1.3	K2.1	K2.2	K2.3	K3.1	K3.2	N1.1	N1.2	N1.3	N2.1	N2.2
■	■	■	■	■	■	■	■	■	■	■	■	■	■
N2.3	N3.1	N3.2	N3.3	N4.1	N4.2								
■	■	■	■	■	■								

DCON MS tolerancia h11; DC <= 2.5mm Estrías rectas, forma A.

Producto	nom d	DC_1	DC_2	OAL	LCF	NOF	WSC	DCON MS
		(mm)	(mm)	(mm)	(mm)		(mm)	(mm)
B9521.2	1.2	1.10	1.74	50.0	32.0	3	2.40	3.15
B9521.5	1.5	1.40	2.14	57.0	37.0	3	2.40	3.15
B9522.0	2.0	1.90	2.86	68.0	48.0	3	2.40	3.15
B9522.5	2.5	2.40	3.36	68.0	48.0	4	2.40	3.15
B9523.0	3.0	2.90	4.06	80.0	58.0	5	3.00	4.00
B9523.5	3.5	3.40	4.66	87.0	63.0	5	3.40	4.50
B9524.0	4.0	3.90	5.26	93.0	68.0	5	3.80	5.00
B9524.5	4.5	4.40	5.80	95.0	70.0	5	4.30	5.60
B9525.0	5.0	4.90	6.36	100.0	73.0	5	4.90	6.30
B9525.5	5.5	5.40	7.20	118.0	90.0	6	5.50	7.10
B9526.0	6.0	5.90	8.00	135.0	105.0	6	6.20	8.00
B9526.5	6.5	6.40	8.60	140.0	110.0	6	6.20	8.00
B9527.0	7.0	6.90	9.40	160.0	125.0	6	7.00	9.00
B9528.0	8.0	7.90	10.80	180.0	145.0	6	8.00	10.00
B9529.0	9.0	8.90	12.10	195.0	160.0	6	9.00	11.20
B95210.0	10.0	9.90	13.40	215.0	175.0	6	10.00	12.50
B95212.0	12.0	11.80	16.00	255.0	210.0	8	11.00	14.00
B95213.0	13.0	12.80	17.00	255.0	210.0	8	12.00	16.00
B95214.0	14.0	13.80	18.00	255.0	210.0	8	12.00	16.00
B95216.0	16.0	15.80	20.40	280.0	230.0	8	14.50	18.00
B95220.0	20.0	19.80	24.80	310.0	250.0	8	18.00	22.40
B95225.0	25.0	24.70	30.70	370.0	300.0	10	22.00	28.00
B95230.0	30.0	29.70	36.10	400.0	320.0	10	24.00	31.50
B95240.0	40.0	39.70	46.50	430.0	340.0	12	32.00	40.00
B95250.0	50.0	49.70	56.90	460.0	360.0	12	39.00	50.00



B122



Escariador de Mano HSS, Mango Reducido, Hélice a Izquierda, Templado al Vapor y Acabado Bronce

Diseñado para realinear agujeros en chapas de acero delgadas, antes de atornillarlas o remacharlas. Diseñado para utilizar a mano. El pequeño diámetro del piloto simplifica la ubicación y alineación de la herramienta en agujeros pretaladrados. Adecuado para escariado en muchos materiales.

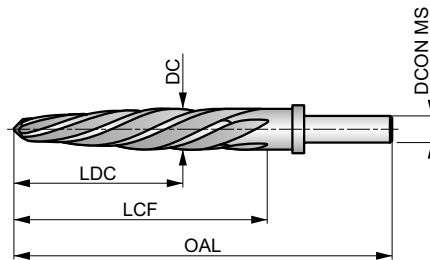

HSS	ST Bronze	ANSI
R		

Grupo de Material de la pieza adecuado y condiciones de velocidad de corte iniciales (m/min) y código de avance alfabético. Tablas con avance por revolución a partir de la pag.251.

P1.1 ■ 15 C	P1.2 ■ 16 C	P1.3 ■ 17 C	P2.1 ■ 13 C	P2.2 ■ 11 C	P3.1 ■ 7 B	M1.1 ■ 11 C	M1.2 ■ 10 B	M2.1 ■ 9 B	N1.1 ■ 23 F	N1.2 ■ 17 F	N2.1 ■ 23 E	N2.2 ■ 21 E	N3.1 ■ 34 D
N3.2 ■ 20 E	N4.1 ■ 22 B	N4.2 ■ 21 B											

Producto	DC (inch)	DC (inch)	OAL (inch)	LCF (inch)	NOF	DCONMS (inch)
B1223/8	3/8	0.3750	4.5/8	2.1/2	4	3/8
B1221/2	1/2	0.5000	5.7/8	3.3/4	5	1/2
B1229/16	9/16	0.5625	5.7/8	3.3/4	5	1/2
B1225/8	5/8	0.6250	6.3/8	4.1/4	5	1/2
B12211/16	11/16	0.6875	6.3/8	4.1/4	5	1/2
B1223/4	3/4	0.7500	6.7/8	4.1/2	5	1/2
B12213/16	13/16	0.8125	6.7/8	4.1/2	5	1/2
B1227/8	7/8	0.8750	6.7/8	4.1/2	5	1/2
B12215/16	15/16	0.9375	6.7/8	4.1/2	5	1/2
B1221	1"	1.0000	6.7/8	4.1/2	5	1/2
B1221.1/16	1.1/16	1.0625	6.7/8	4.1/2	5	1/2



B953



Escariador de Máquina HSS-E para Pasadores Cónicos, Conicidad 1:50, Mango Cilíndrico

Con gran ángulo de hélice y corte a derecha y a izquierda. El cono del escariador está diseñado para terminar los agujeros cónicos para alojar pasadores cónicos métricos de proporción estándar de 1 a 50, mientras que la punta cónica tiene un diámetro reducido para mejorar el rendimiento. Adecuado para escariar en muchos materiales.

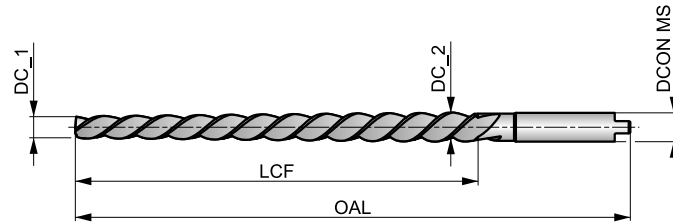

HSS-E	Bright	DIN 2179
R		1:50

Grupo de Material de la pieza adecuado y condiciones de velocidad de corte iniciales (m/min) y código de avance alfabético. Tablas con avance por revolución a partir de la pag.251.

P1.1 ■ 10 B	P1.2 ■ 12 B	P1.3 ■ 13 B	P2.1 ■ 9 B	P2.2 ■ 8 B	P2.3 ▣ 6 A	P3.1 ■ 7 A	P3.2 ▣ 6 A	P3.3 ▣ 3 A	P4.1 ■ 4 A	P4.2 ▣ 3 A	P4.3 ▣ 2 A	M1.1 ▣ 11 C	M1.2 ▣ 10 B
M2.1 ▣ 9 B	M2.2 ▣ 8 B	K1.1 ■ 10 C	K1.2 ■ 6 B	K1.3 ▣ 4 B	K2.1 ■ 8 A	K2.2 ■ 6 A	K2.3 ▣ 4 A	K3.1 ■ 7 A	K3.2 ▣ 4 A	N1.1 ▣ 14 D	N1.2 ■ 12 D	N1.3 ■ 9 D	N2.1 ■ 16 C
N2.2 ■ 14 C	N2.3 ▣ 10 C	N3.1 ■ 22 B	N3.2 ■ 14 C	N3.3 ▣ 6 B	N4.1 ▣ 22 B								

DCON MS tolerancia h9.

Producto	nom d	DC_1	DC_2	OAL	LCF	NOF	DCON MS
		(mm)	(mm)	(mm)	(mm)		(mm)
B9531.0	1.0	0.80	1.46	60.0	33.0	2	1.40
B9531.5	1.5	1.40	2.14	70.0	37.0	2	2.10
B9532.0	2.0	1.90	2.86	86.0	48.0	3	3.15
B9532.5	2.5	2.40	3.36	86.0	48.0	3	3.15
B9533.0	3.0	2.90	4.06	100.0	58.0	3	4.00
B9534.0	4.0	3.90	5.26	112.0	68.0	3	5.00
B9535.0	5.0	4.90	6.36	122.0	73.0	3	6.30
B9536.0	6.0	5.90	8.00	160.0	105.0	3	8.00
B9536.5	6.5	6.40	8.78	188.0	119.0	3	8.50
B9538.0	8.0	7.90	10.80	207.0	145.0	3	10.00
B95310.0	10.0	9.90	13.40	245.0	175.0	3	12.50
B95312.0	12.0	11.80	16.00	290.0	210.0	3	16.00



B180



Escariador de Máquina HSS-E, Mango Cilíndrico, Tolerancia H7, Acabado Brillante

Escariador de alto rendimiento para máquinas CNC y montaje en portaherramientas o mandriles de alta precisión. La hélice rectificada con precisión a izquierda y la acción de corte a derecha garantizan un escariado suave y un mejor acabado superficial y tamaño del agujero. Adecuado para escariar en muchos materiales.

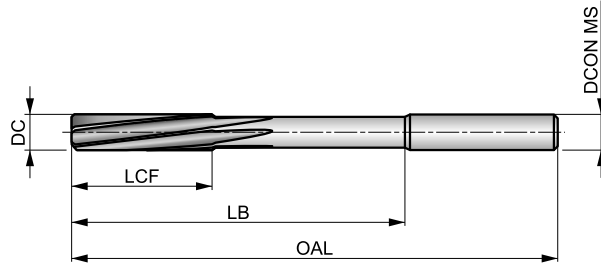

HSS-E	Bright	DIN 212
R	DIN 6535HA	B
H7		

Grupo de Material de la pieza adecuado y condiciones de velocidad de corte iniciales (m/min) y código de avance alfabético. Tablas con avance por revolución a partir de la pag.251.

P1.1 ■ 21 C	P1.2 ■ 24 C	P1.3 ■ 25 C	P2.1 ■ 18 C	P2.2 ■ 16 C	P2.3 ■ 14 B	P3.1 ■ 13 B	P3.2 ■ 11 B	P3.3 ■ 9 B	P4.1 ■ 8 B	P4.2 ■ 7 B	P4.3 ■ 5 A	M1.1 ■ 11 C	M1.2 ■ 10 B
M2.1 ■ 9 B	K1.1 ■ 16 E	K1.2 ■ 12 D	K1.3 ■ 9 D	K2.1 ■ 16 C	K2.2 ■ 13 C	K2.3 ■ 10 C	K3.1 ■ 14 C	K3.2 ■ 11 C	N1.1 ■ 24 F	N1.2 ■ 18 F	N1.3 ■ 11 F	N2.1 ■ 27 E	N2.2 ■ 24 E
N2.3 ■ 16 E	N3.1 ■ 47 D	N3.2 ■ 28 E	N3.3 ■ 14 D	N4.1 ■ 30 B									

DCON MS tolerancia h6.

Producto	DC (mm)	OAL (mm)	LCF (mm)	LB (mm)	NOF	DCON MS (mm)
B1801.5	1.50	40.0	8.0	18.00	3	2.00
B1801.6	1.60	43.0	9.0	20.00	3	2.00
B1801.7	1.70	43.0	9.0	20.00	3	2.00
B1801.8	1.80	46.0	10.0	22.00	4	2.00
B1801.9	1.90	46.0	10.0	22.00	4	2.00
B1802.0	2.00	49.0	11.0	24.00	4	2.00
B1802.1	2.10	49.0	11.0	24.00	4	2.00
B1802.2	2.20	53.0	12.0	26.00	4	3.00
B1802.3	2.30	53.0	12.0	26.00	4	3.00
B1802.4	2.40	57.0	14.0	28.00	4	3.00
B1802.5	2.50	57.0	14.0	28.00	4	3.00
B1802.6	2.60	57.0	14.0	28.00	4	3.00
B1802.7	2.70	61.0	15.0	32.00	6	3.00
B1802.8	2.80	61.0	15.0	32.00	6	3.00
B1802.9	2.90	61.0	15.0	32.00	6	3.00
B1803.0	3.00	61.0	15.0	32.00	6	3.00
B1803.1	3.10	65.0	16.0	35.00	6	4.00
B1803.2	3.20	65.0	16.0	35.00	6	4.00
B1803.3	3.30	65.0	16.0	35.00	6	4.00
B1803.4	3.40	70.0	18.0	40.00	6	4.00
B1803.5	3.50	70.0	18.0	40.00	6	4.00
B1803.6	3.60	70.0	18.0	40.00	6	4.00
B1803.7	3.70	70.0	18.0	40.00	6	4.00
B1803.8	3.80	75.0	19.0	43.00	6	4.00
B1803.9	3.90	75.0	19.0	43.00	6	4.00
B1804.0	4.00	75.0	19.0	43.00	6	4.00
B1804.1	4.10	75.0	19.0	43.00	6	4.00

Producto	DC (mm)	OAL (mm)	LCF (mm)	LB (mm)	NOF	DCON MS (mm)
B1804.2	4.20	75.0	19.0	43.00	6	4.00
B1804.3	4.30	80.0	21.0	47.00	6	5.00
B1804.4	4.40	80.0	21.0	47.00	6	5.00
B1804.5	4.50	80.0	21.0	47.00	6	5.00
B1804.6	4.60	80.0	21.0	47.00	6	5.00
B1804.7	4.70	80.0	21.0	47.00	6	5.00
B1804.8	4.80	86.0	23.0	52.00	6	5.00
B1804.9	4.90	86.0	23.0	52.00	6	5.00
B1805.0	5.00	86.0	23.0	52.00	6	5.00
B1805.1	5.10	86.0	23.0	52.00	6	5.00
B1805.2	5.20	86.0	23.0	52.00	6	5.00
B1805.3	5.30	86.0	23.0	52.00	6	5.00
B1805.4	5.40	93.0	26.0	57.00	6	6.00
B1805.5	5.50	93.0	26.0	57.00	6	6.00
B1805.6	5.60	93.0	26.0	57.00	6	6.00
B1805.7	5.70	93.0	26.0	57.00	6	6.00
B1805.8	5.80	93.0	26.0	57.00	6	6.00
B1805.9	5.90	93.0	26.0	57.00	6	6.00
B1806.0	6.00	93.0	26.0	57.00	6	6.00
B1806.1	6.10	101.0	28.0	63.00	6	6.00
B1806.2	6.20	101.0	28.0	63.00	6	6.00
B1806.3	6.30	101.0	28.0	63.00	6	6.00
B1806.4	6.40	101.0	28.0	63.00	6	6.00
B1806.5	6.50	101.0	28.0	63.00	6	6.00
B1806.6	6.60	101.0	28.0	63.00	6	6.00
B1806.7	6.70	101.0	28.0	63.00	6	6.00
B1806.8	6.80	109.0	31.0	69.00	6	8.00



Producto	DC	OAL	LCF	LB	NOF	DCON MS
	(mm)	(mm)	(mm)	(mm)		(mm)
B1806.9	6.90	109.0	31.0	69.00	6	8.00
B1807.0	7.00	109.0	31.0	69.00	6	8.00
B1807.1	7.10	109.0	31.0	69.00	6	8.00
B1807.2	7.20	109.0	31.0	69.00	6	8.00
B1807.3	7.30	109.0	31.0	69.00	6	8.00
B1807.4	7.40	109.0	31.0	69.00	6	8.00
B1807.5	7.50	109.0	31.0	69.00	6	8.00
B1807.6	7.60	117.0	33.0	75.00	6	8.00
B1807.7	7.70	117.0	33.0	75.00	6	8.00
B1807.8	7.80	117.0	33.0	75.00	6	8.00
B1807.9	7.90	117.0	33.0	75.00	6	8.00
B1808.0	8.00	117.0	33.0	75.00	6	8.00
B1808.1	8.10	117.0	33.0	75.00	6	8.00
B1808.2	8.20	117.0	33.0	75.00	6	8.00
B1808.3	8.30	117.0	33.0	75.00	6	8.00
B1808.4	8.40	117.0	33.0	75.00	6	8.00
B1808.5	8.50	117.0	33.0	75.00	6	8.00
B1808.6	8.60	125.0	36.0	81.00	6	10.00
B1808.7	8.70	125.0	36.0	81.00	6	10.00
B1808.8	8.80	125.0	36.0	81.00	6	10.00
B1808.9	8.90	125.0	36.0	81.00	6	10.00

Producto	DC	OAL	LCF	LB	NOF	DCON MS
	(mm)	(mm)	(mm)	(mm)		(mm)
B1809.0	9.00	125.0	36.0	81.00	6	10.00
B1809.1	9.10	125.0	36.0	81.00	6	10.00
B1809.2	9.20	125.0	36.0	81.00	6	10.00
B1809.3	9.30	125.0	36.0	81.00	6	10.00
B1809.4	9.40	125.0	36.0	81.00	6	10.00
B1809.5	9.50	125.0	36.0	81.00	6	10.00
B1809.6	9.60	133.0	38.0	87.00	6	10.00
B1809.7	9.70	133.0	38.0	87.00	6	10.00
B1809.8	9.80	133.0	38.0	87.00	6	10.00
B1809.9	9.90	133.0	38.0	87.00	6	10.00
B18010.0	10.00	133.0	38.0	87.00	6	10.00
B18011.0	11.00	142.0	41.0	96.00	6	10.00
B18012.0	12.00	151.0	44.0	105.00	6	10.00
B18013.0	13.00	151.0	44.0	105.00	6	10.00
B18014.0	14.00	160.0	47.0	110.00	8	14.00
B18015.0	15.00	162.0	50.0	112.00	8	14.00
B18016.0	16.00	170.0	52.0	120.00	8	14.00
B18017.0	17.00	175.0	54.0	123.00	8	14.00
B18018.0	18.00	182.0	56.0	130.00	8	14.00
B18019.0	19.00	189.0	58.0	131.00	8	16.00
B18020.0	20.00	195.0	60.0	137.00	8	16.00



B170



Escariador de Máquina HSS-E Centesimal, Mango Cilíndrico, Incrementos de 0.01 mm, Acabado Brillante
 Los diferentes incrementos de tamaño le permiten producir agujeros precisos y tolerancias adicionales. Con una hélice a izquierda y una acción de corte a derecha, la geometría rectificada de precisión proporciona un escariado suave y mejora el tamaño del agujero y el acabado superficial. Adecuado para escariar en muchos materiales.

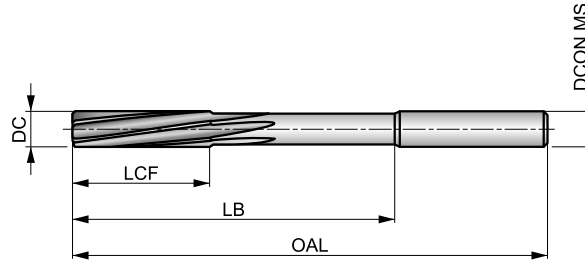

HSS-E	Bright	DIN 212
R		B
$\phi_{.95-5.5}$ $+0.004$ $\phi_{5.51-12}$ $+0.005$		

Grupo de Material de la pieza adecuado y condiciones de velocidad de corte iniciales (m/min) y código de avance alfabético. Tablas con avance por revolución a partir de la pag.251.

P1.1 ■ 21 C	P1.2 ■ 24 C	P1.3 ■ 25 C	P2.1 ■ 18 C	P2.2 ■ 16 C	P2.3 ■ 14 B	P3.1 ■ 13 B	P3.2 ■ 11 B	P3.3 ■ 9 B	P4.1 ■ 8 B	P4.2 ■ 7 B	P4.3 ■ 5 A	M1.1 ■ 11 C	M1.2 ■ 10 B
M2.1 ■ 9 B	K1.1 ■ 16 E	K1.2 ■ 12 D	K1.3 ■ 9 D	K2.1 ■ 16 C	K2.2 ■ 13 C	K2.3 ■ 10 C	K3.1 ■ 14 C	K3.2 ■ 11 C	N1.1 ■ 24 D	N1.2 ■ 18 F	N1.3 ■ 11 F	N2.1 ■ 27 E	N2.2 ■ 24 E
N2.3 ■ 16 E	N3.1 ■ 47 D	N3.2 ■ 28 E	N3.3 ■ 14 D	N4.1 ■ 30 B									

DCON MS tolerancia h9.

Producto	DC	OAL	LCF	LB	NOF	DCON MS
	(mm)	(mm)	(mm)	(mm)		(mm)
B170.98	0.98	34.0	5.5	15.00	3	1.00
B170.99	0.99	34.0	5.5	15.00	3	1.00
B1701.0	1.00	34.0	5.5	15.00	3	1.00
B1701.01	1.01	34.0	5.5	15.00	3	1.00
B1701.02	1.02	34.0	5.5	15.00	3	1.00
B1701.03	1.03	34.0	5.5	15.00	3	1.00
B1701.04	1.04	34.0	5.5	15.00	3	1.00
B1701.05	1.05	34.0	5.5	15.00	3	1.00
B1701.49	1.49	40.0	8.0	18.00	3	1.50
B1701.5	1.50	40.0	8.0	18.00	3	1.50
B1701.51	1.51	43.0	9.0	20.00	3	1.60
B1701.52	1.52	43.0	9.0	20.00	3	1.60
B1701.98	1.98	49.0	11.0	24.00	4	2.00
B1701.99	1.99	49.0	11.0	24.00	4	2.00
B1702.0	2.00	49.0	11.0	24.00	4	2.00
B1702.01	2.01	49.0	11.0	24.00	4	2.00
B1702.02	2.02	49.0	11.0	24.00	4	2.00
B1702.03	2.03	49.0	11.0	24.00	4	2.00
B1702.04	2.04	49.0	11.0	24.00	4	2.00
B1702.05	2.05	49.0	11.0	24.00	4	2.00
B1702.49	2.49	57.0	14.0	28.00	4	2.50
B1702.5	2.50	57.0	14.0	28.00	4	2.50
B1702.51	2.51	57.0	14.0	28.00	4	2.50
B1702.52	2.52	57.0	14.0	28.00	4	2.50
B1702.98	2.98	61.0	15.0	32.00	6	3.00
B1702.99	2.99	61.0	15.0	32.00	6	3.00
B1703.0	3.00	61.0	15.0	32.00	6	3.00

Producto	DC	OAL	LCF	LB	NOF	DCON MS
	(mm)	(mm)	(mm)	(mm)		(mm)
B1703.01	3.01	65.0	16.0	35.00	6	3.20
B1703.02	3.02	65.0	16.0	35.00	6	3.20
B1703.03	3.03	65.0	16.0	35.00	6	3.20
B1703.04	3.04	65.0	16.0	35.00	6	3.20
B1703.05	3.05	65.0	16.0	35.00	6	3.20
B1703.49	3.49	70.0	18.0	40.00	6	3.50
B1703.5	3.50	70.0	18.0	40.00	6	3.50
B1703.51	3.51	70.0	18.0	40.00	6	3.50
B1703.52	3.52	70.0	18.0	40.00	6	3.50
B1703.98	3.98	75.0	19.0	43.00	6	4.00
B1703.99	3.99	75.0	19.0	43.00	6	4.00
B1704.0	4.00	75.0	19.0	43.00	6	4.00
B1704.01	4.01	75.0	19.0	43.00	6	4.00
B1704.02	4.02	75.0	19.0	43.00	6	4.00
B1704.03	4.03	75.0	19.0	43.00	6	4.00
B1704.04	4.04	75.0	19.0	43.00	6	4.00
B1704.05	4.05	75.0	19.0	43.00	6	4.00
B1704.49	4.49	80.0	21.0	47.00	6	4.50
B1704.5	4.50	80.0	21.0	47.00	6	4.50
B1704.51	4.51	80.0	21.0	47.00	6	4.50
B1704.52	4.52	80.0	21.0	47.00	6	4.50
B1704.98	4.98	86.0	23.0	52.00	6	5.00
B1704.99	4.99	86.0	23.0	52.00	6	5.00
B1705.0	5.00	86.0	23.0	52.00	6	5.00
B1705.01	5.01	86.0	23.0	52.00	6	5.00
B1705.02	5.02	86.0	23.0	52.00	6	5.00
B1705.03	5.03	86.0	23.0	52.00	6	5.00



Producto	DC	OAL	LCF	LB	NOF	DCON MS
	(mm)	(mm)	(mm)	(mm)		(mm)
B1705.04	5.04	86.0	23.0	52.00	6	5.00
B1705.05	5.05	86.0	23.0	52.00	6	5.00
B1705.49	5.49	93.0	26.0	57.00	6	5.60
B1705.5	5.50	93.0	26.0	57.00	6	5.60
B1705.51	5.51	93.0	26.0	57.00	6	5.60
B1705.52	5.52	93.0	26.0	57.00	6	5.60
B1705.98	5.98	93.0	26.0	57.00	6	5.60
B1705.99	5.99	93.0	26.0	57.00	6	5.60
B1706.0	6.00	93.0	26.0	57.00	6	5.60
B1706.01	6.01	101.0	28.0	63.00	6	6.30
B1706.02	6.02	101.0	28.0	63.00	6	6.30
B1706.03	6.03	101.0	28.0	63.00	6	6.30
B1706.04	6.04	101.0	28.0	63.00	6	6.30
B1706.05	6.05	101.0	28.0	63.00	6	6.30
B1706.49	6.49	101.0	28.0	63.00	6	6.30
B1706.5	6.50	101.0	28.0	63.00	6	6.30
B1706.51	6.51	101.0	28.0	63.00	6	6.30
B1706.52	6.52	101.0	28.0	63.00	6	6.30
B1706.98	6.98	109.0	31.0	69.00	6	7.10
B1706.99	6.99	109.0	31.0	69.00	6	7.10
B1707.0	7.00	109.0	31.0	69.00	6	7.10
B1707.01	7.01	109.0	31.0	69.00	6	7.10
B1707.02	7.02	109.0	31.0	69.00	6	7.10
B1707.03	7.03	109.0	31.0	69.00	6	7.10
B1707.04	7.04	109.0	31.0	69.00	6	7.10
B1707.05	7.05	109.0	31.0	69.00	6	7.10
B1707.49	7.49	109.0	31.0	69.00	6	7.10
B1707.5	7.50	109.0	31.0	69.00	6	7.10
B1707.51	7.51	117.0	33.0	75.00	6	8.00
B1707.52	7.52	117.0	33.0	75.00	6	8.00
B1707.98	7.98	117.0	33.0	75.00	6	8.00
B1707.99	7.99	117.0	33.0	75.00	6	8.00
B1708.0	8.00	117.0	33.0	75.00	6	8.00
B1708.01	8.01	117.0	33.0	75.00	6	8.00
B1708.02	8.02	117.0	33.0	75.00	6	8.00
B1708.03	8.03	117.0	33.0	75.00	6	8.00
B1708.04	8.04	117.0	33.0	75.00	6	8.00
B1708.05	8.05	117.0	33.0	75.00	6	8.00
B1708.49	8.49	117.0	33.0	75.00	6	8.00
B1708.5	8.50	117.0	33.0	75.00	6	8.00

Producto	DC	OAL	LCF	LB	NOF	DCON MS
	(mm)	(mm)	(mm)	(mm)		(mm)
B1708.51	8.51	125.0	36.0	81.00	6	9.00
B1708.52	8.52	125.0	36.0	81.00	6	9.00
B1708.98	8.98	125.0	36.0	81.00	6	9.00
B1708.99	8.99	125.0	36.0	81.00	6	9.00
B1709.0	9.00	125.0	36.0	81.00	6	9.00
B1709.01	9.01	125.0	36.0	81.00	6	9.00
B1709.02	9.02	125.0	36.0	81.00	6	9.00
B1709.03	9.03	125.0	36.0	81.00	6	9.00
B1709.04	9.04	125.0	36.0	81.00	6	9.00
B1709.05	9.05	125.0	36.0	81.00	6	9.00
B1709.49	9.49	125.0	36.0	81.00	6	9.00
B1709.5	9.50	125.0	36.0	81.00	6	9.00
B1709.51	9.51	133.0	38.0	87.00	6	10.00
B1709.52	9.52	133.0	38.0	87.00	6	10.00
B1709.98	9.98	133.0	38.0	87.00	6	10.00
B1709.99	9.99	133.0	38.0	87.00	6	10.00
B17010.0	10.00	133.0	38.0	87.00	6	10.00
B17010.01	10.01	133.0	38.0	87.00	6	10.00
B17010.02	10.02	133.0	38.0	87.00	6	10.00
B17010.03	10.03	133.0	38.0	87.00	6	10.00
B17010.04	10.04	133.0	38.0	87.00	6	10.00
B17010.05	10.05	133.0	38.0	87.00	6	10.00
B17010.49	10.49	133.0	38.0	87.00	6	10.00
B17010.51	10.51	133.0	38.0	87.00	6	10.00
B17010.52	10.52	133.0	38.0	87.00	6	10.00
B17010.98	10.98	142.0	41.0	96.00	6	10.00
B17010.99	10.99	142.0	41.0	96.00	6	10.00
B17011.0	11.00	142.0	41.0	96.00	6	10.00
B17011.01	11.01	142.0	41.0	96.00	6	10.00
B17011.02	11.02	142.0	41.0	96.00	6	10.00
B17011.03	11.03	142.0	41.0	96.00	6	10.00
B17011.04	11.04	142.0	41.0	96.00	6	10.00
B17011.05	11.05	142.0	41.0	96.00	6	10.00
B17011.49	11.49	142.0	41.0	96.00	6	10.00
B17011.5	11.50	142.0	41.0	96.00	6	10.00
B17011.51	11.51	142.0	41.0	96.00	6	10.00
B17011.52	11.52	142.0	41.0	96.00	6	10.00
B17011.98	11.98	151.0	44.0	105.00	6	10.00
B17011.99	11.99	151.0	44.0	105.00	6	10.00
B17012.0	12.00	151.0	44.0	105.00	6	10.00



B157



Escariador de Máquina HSS-E de Hélice Rápida, Mango Cilíndrico, Tolerancia H7, Acabado Brillante

El gran ángulo de hélice a izquierda y el corte a derecha ofrecen un escariado suave, particularmente al mecanizar materiales no ferreos, como el aluminio. También es adecuado para escariar otros materiales. La entrada cónica hace que sea fácil de ubicar y centrar, lo que garantiza un mejor rendimiento y calidad del agujero.

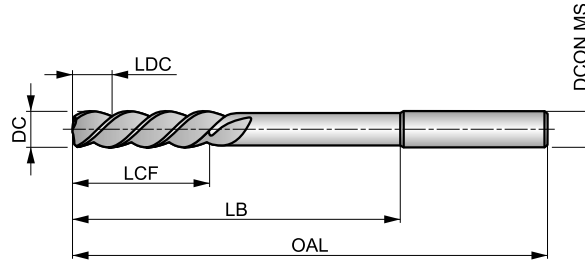

HSS-E	Bright	DIN 212
R		E
H7		

Grupo de Material de la pieza adecuado y condiciones de velocidad de corte iniciales (m/min) y código de avance alfabético. Tablas con avance por revolución a partir de la pag.251.

P1.1 ■ 21 C	P1.2 ■ 24 C	P1.3 ■ 25 C	P2.1 ■ 18 C	P2.2 ■ 16 C	P3.1 ■ 13 B	P3.2 ■ 11 B	M1.1 ■ 11 C	M1.2 ■ 10 C	M2.1 ■ 9 C	M2.2 ■ 8 B	M2.3 ■ 7 B	N1.1 ■ 28 F	N1.2 ■ 21 F
N1.3 ■ 14 F	N2.1 ■ 31 E	N2.2 ■ 28 E	N2.3 ■ 20 E										

DCON MS tolerancia h9.

Producto	DC (mm)	OAL (mm)	LCF (mm)	LDC (mm)	LB (mm)	NOF	DCON MS (mm)
B1572.0	2.00	49.0	11.0	3.50	24.00	3	2.00
B1573.0	3.00	61.0	15.0	4.00	32.00	3	3.00
B1574.0	4.00	75.0	19.0	4.00	43.00	3	4.00
B1575.0	5.00	86.0	23.0	4.50	52.00	3	5.00
B1576.0	6.00	93.0	26.0	6.00	57.00	3	5.60
B1577.0	7.00	109.0	31.0	7.00	69.00	3	7.10
B1578.0	8.00	117.0	33.0	9.00	75.00	3	8.00
B1579.0	9.00	125.0	36.0	9.50	81.00	3	9.00
B15710.0	10.00	133.0	38.0	10.00	87.00	3	10.00
B15711.0	11.00	142.0	41.0	10.50	96.00	3	10.00
B15712.0	12.00	151.0	44.0	11.00	105.00	3	10.00
B15713.0	13.00	151.0	44.0	11.50	105.00	3	10.00
B15714.0	14.00	160.0	47.0	12.00	110.00	3	12.50
B15715.0	15.00	162.0	50.0	12.50	112.00	3	12.50
B15716.0	16.00	170.0	52.0	13.00	120.00	3	12.50
B15717.0	17.00	175.0	54.0	13.50	123.00	3	14.00
B15718.0	18.00	182.0	56.0	14.00	130.00	3	14.00
B15719.0	19.00	189.0	58.0	14.50	131.00	3	16.00
B15720.0	20.00	195.0	60.0	15.00	137.00	3	16.00



B161



Escariador de Máquina HSS-E, Mango Cónico, Tolerancia H7, Acabado Brillante/Templado al Vapor

La hélice rectificada con precisión a izquierda y la acción de corte a derecha garantizan un escariado suave y un mejor acabado superficial y tamaño del agujero. Adecuado para escariar en muchos materiales.

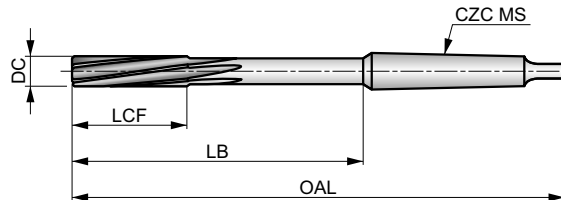

HSS-E	Bright	DIN 208
R		B
H7		

Grupo de Material de la pieza adecuado y condiciones de velocidad de corte iniciales (m/min) y código de avance alfabético. Tablas con avance por revolución a partir de la pag.251.

P1.1 ■ 21 C	P1.2 ■ 24 C	P1.3 ■ 25 C	P2.1 ■ 18 C	P2.2 ■ 16 C	P2.3 ▣ 14 B	P3.1 ■ 13 B	P3.2 ■ 11 B	P3.3 ▣ 9 B	P4.1 ■ 8 B	P4.2 ▣ 7 B	P4.3 ▣ 5 A	M1.1 ▣ 11 C	M1.2 ▣ 10 B
M2.1 ▣ 9 B	K1.1 ■ 16 E	K1.2 ■ 12 D	K1.3 ▣ 9 D	K2.1 ■ 16 C	K2.2 ■ 13 C	K2.3 ▣ 10 C	K3.1 ■ 14 C	K3.2 ▣ 11 C	N1.1 ▣ 24 F	N1.2 ■ 18 F	N1.3 ■ 11 F	N2.1 ▣ 27 E	N2.2 ■ 24 E
N2.3 ■ 16 E	N3.1 ■ 47 D	N3.2 ■ 28 E	N3.3 ▣ 14 D	N4.1 ▣ 30 B									

Producto	DC	OAL	LCF	LB	NOF	CZC MS
	(mm)	(mm)	(mm)	(mm)		
B1613.0	3.00	113.0	15.0	47.50	6	MK 1
B1614.0	4.00	124.0	19.0	58.50	6	MK 1
B1615.0	5.00	133.0	23.0	67.50	6	MK 1
B1616.0	6.00	138.0	26.0	72.50	6	MK 1
B1617.0	7.00	150.0	31.0	84.50	6	MK 1
B1618.0	8.00	156.0	33.0	90.50	6	MK 1
B1619.0	9.00	162.0	36.0	96.50	6	MK 1
B16110.0	10.00	168.0	38.0	102.50	6	MK 1
B16111.0	11.00	175.0	41.0	109.50	6	MK 1
B16112.0	12.00	182.0	44.0	116.50	6	MK 1
B16113.0	13.00	182.0	44.0	116.50	6	MK 1
B16114.0	14.00	189.0	47.0	123.50	8	MK 1
B16115.0	15.00	204.0	50.0	124.00	8	MK 2
B16116.0	16.00	210.0	52.0	130.00	8	MK 2
B16117.0	17.00	214.0	54.0	134.00	8	MK 2
B16118.0	18.00	219.0	56.0	139.00	8	MK 2
B16119.0	19.00	223.0	58.0	143.00	8	MK 2
B16120.0	20.00	228.0	60.0	148.00	8	MK 2
B16121.0	21.00	232.0	62.0	152.00	8	MK 2
B16122.0	22.00	237.0	64.0	157.00	8	MK 2
B16123.0	23.00	241.0	66.0	161.00	8	MK 2
B16124.0	24.00	268.0	68.0	169.00	8	MK 3

Producto	DC	OAL	LCF	LB	NOF	CZC MS
	(mm)	(mm)	(mm)	(mm)		
B16125.0	25.00	268.0	68.0	169.00	8	MK 3
B16126.0	26.00	273.0	70.0	174.00	8	MK 3
B16127.0	27.00	277.0	71.0	178.00	10	MK 3
B16128.0	28.00	277.0	71.0	178.00	10	MK 3
B16129.0	29.00	281.0	73.0	182.00	10	MK 3
B16130.0	30.00	281.0	73.0	182.00	10	MK 3
B16131.0	31.00	285.0	75.0	186.00	10	MK 3
B16132.0	32.00	317.0	77.0	193.00	10	MK 4
B16133.0	33.00	317.0	77.0	193.00	10	MK 4
B16134.0	34.00	321.0	78.0	197.00	10	MK 4
B16135.0	35.00	321.0	78.0	197.00	10	MK 4
B16136.0	36.00	325.0	79.0	201.00	10	MK 4
B16138.0	38.00	329.0	81.0	205.00	10	MK 4
B16140.0	40.00	329.0	81.0	205.00	10	MK 4
B16142.0	42.00	333.0	82.0	209.00	12	MK 4
B16144.0	44.00	336.0	83.0	212.00	12	MK 4
B16145.0	45.00	336.0	83.0	212.00	12	MK 4
B16146.0	46.00	340.0	84.0	216.00	12	MK 4
B16147.0	47.00	340.0	84.0	216.00	12	MK 4
B16148.0	48.00	344.0	86.0	220.00	12	MK 4
B16150.0	50.00	344.0	86.0	220.00	12	MK 4



B101



Escariador HSS-E de Máquina, Mango Cónico, Tolerancia H7

Escariador de máquina de mango cónico según BS 328. La hélice rectificada con precisión a izquierda y la acción de corte a derecha garantizan un escariado suave y un mejor acabado superficial y tamaño del agujero. Adecuado para escariar en muchos materiales.

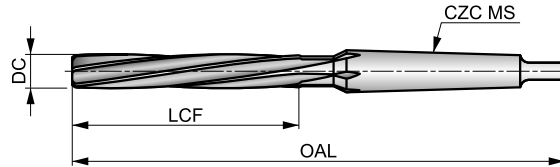

HSS-E	Bright ST	BS 328
R		B
H7		

Grupo de Material de la pieza adecuado y condiciones de velocidad de corte iniciales (m/min) y código de avance alfabético. Tablas con avance por revolución a partir de la pag.251.

P1.1 ■ 15 C	P1.2 ■ 16 C	P1.3 ■ 17 C	P2.1 ■ 13 C	P2.2 ■ 11 C	P2.3 ▣ 10 B	P3.1 ■ 7 B	P3.2 ■ 6 B	P3.3 ▣ 5 B	P4.1 ■ 4 B	P4.2 ▣ 4 B	P4.3 ▣ 3 A	M1.1 ▣ 7 B	M1.2 ▣ 6 A
K1.1 ■ 14 E	K1.2 ■ 10 D	K1.3 ▣ 8 D	K2.1 ■ 12 C	K2.2 ■ 10 C	K2.3 ▣ 8 C	K3.1 ■ 11 C	K3.2 ▣ 8 C	N1.1 ▣ 23 F	N1.2 ■ 17 F	N1.3 ■ 9 F	N2.1 ▣ 25 E	N2.2 ■ 18 E	N2.3 ■ 14 E
N3.1 ■ 34 D	N3.2 ■ 20 E	N3.3 ▣ 10 D	N4.1 ▣ 22 B										

Producto	DC (inch)	DC (mm)	OAL (mm)	LCF (mm)	NOF	CZC MS
B1013.0	—	3.00	112.0	33.0	4	MK 1
B1011/8	1/8	3.18	112.0	33.0	4	MK 1
B1013.5	—	3.50	115.0	35.0	6	MK 1
B1014.0	—	4.00	117.0	38.0	6	MK 1
B1014.5	—	4.50	120.0	41.0	6	MK 1
B1013/16	3/16	4.76	124.0	44.0	6	MK 1
B1015.0	—	5.00	124.0	44.0	6	MK 1
B1015.5	—	5.50	127.0	47.0	6	MK 1
B1016.0	—	6.00	127.0	47.0	6	MK 1
B1011/4	1/4	6.35	130.0	50.0	6	MK 1
B1016.5	—	6.50	130.0	50.0	6	MK 1
B1017.0	—	7.00	134.0	54.0	6	MK 1
B1015/16	5/16	7.94	138.0	58.0	6	MK 1
B1018.0	—	8.00	138.0	58.0	6	MK 1
B1018.5	—	8.50	138.0	58.0	6	MK 1
B1019.0	—	9.00	142.0	62.0	6	MK 1
B1019.5	—	9.50	142.0	62.0	6	MK 1
B1013/8	3/8	9.52	146.0	66.0	6	MK 1
B10110.0	—	10.00	146.0	66.0	6	MK 1
B10110.5	—	10.50	146.0	66.0	6	MK 1
B10111.0	—	11.00	151.0	71.0	6	MK 1
B1017/16	7/16	11.11	151.0	71.0	6	MK 1
B10112.0	—	12.00	156.0	76.0	6	MK 1
B10112.5	—	12.50	156.0	76.0	6	MK 1
B1011/2	1/2	12.70	156.0	76.0	6	MK 1
B10113.0	—	13.00	156.0	76.0	6	MK 1
B10113.5	—	13.50	161.0	81.0	6	MK 1
B10114.0	—	14.00	161.0	81.0	8	MK 1

Producto	DC (inch)	DC (mm)	OAL (mm)	LCF (mm)	NOF	CZC MS
B1019/16	9/16	14.29	181.0	81.0	8	MK 2
B10114.5	—	14.50	181.0	81.0	8	MK 2
B10115.0	—	15.00	181.0	81.0	8	MK 2
B10115.5	—	15.50	187.0	87.0	8	MK 2
B1015/8	5/8	15.88	187.0	87.0	8	MK 2
B10116.0	—	16.00	187.0	87.0	8	MK 2
B10116.5	—	16.50	187.0	87.0	8	MK 2
B10117.0	—	17.00	187.0	87.0	8	MK 2
B10118.0	—	18.00	193.0	93.0	8	MK 2
B10119.0	—	19.00	193.0	93.0	8	MK 2
B1013/4	3/4	19.05	200.0	100.0	8	MK 2
B10120.0	—	20.00	200.0	100.0	8	MK 2
B10113/16	13/16	20.64	200.0	100.0	8	MK 2
B10121.0	—	21.00	200.0	100.0	8	MK 2
B10122.0	—	22.00	207.0	107.0	8	MK 2
B1017/8	7/8	22.22	207.0	107.0	8	MK 2
B10123.0	—	23.00	207.0	107.0	8	MK 2
B10124.0	—	24.00	242.0	115.0	8	MK 3
B10125.0	—	25.00	242.0	115.0	10	MK 3
B1011	1"	25.40	242.0	115.0	10	MK 3
B10126.0	—	26.00	242.0	115.0	10	MK 3
B10127.0	—	27.00	251.0	124.0	10	MK 3
B10128.0	—	28.00	251.0	124.0	10	MK 3
B1011.1/8	1.1/8	28.58	251.0	124.0	10	MK 3
B10129.0	—	29.00	251.0	124.0	10	MK 3
B10130.0	—	30.00	251.0	124.0	10	MK 3
B10131.0	—	31.00	260.0	133.0	10	MK 3
B1011.1/4	1.1/4	31.75	260.0	133.0	10	MK 3



Producto	DC	DC	OAL	LCF	NOF	CZC MS
	(inch)	(mm)	(mm)	(mm)		
B10132.0	–	32.00	293.0	133.0	10	MK 4
B10134.0	–	34.00	302.0	142.0	10	MK 4
B1011.3/8	1.3/8	34.93	302.0	142.0	10	MK 4
B10135.0	–	35.00	302.0	142.0	10	MK 4
B10136.0	–	36.00	302.0	142.0	10	MK 4
B10137.0	–	37.00	302.0	142.0	10	MK 4
B10138.0	–	38.00	312.0	152.0	10	MK 4
B1011.1/2	1.1/2	38.10	312.0	152.0	10	MK 4
B10139.0	–	39.00	312.0	152.0	10	MK 4
B10140.0	–	40.00	312.0	152.0	10	MK 4
B10141.0	–	41.00	312.0	152.0	10	MK 4

Producto	DC	DC	OAL	LCF	NOF	CZC MS
	(inch)	(mm)	(mm)	(mm)		
B10142.0	–	42.00	312.0	152.0	10	MK 4
B10143.0	–	43.00	323.0	163.0	10	MK 4
B10144.0	–	44.00	323.0	163.0	10	MK 4
B1011.3/4	1.3/4	44.45	323.0	163.0	10	MK 4
B10145.0	–	45.00	323.0	163.0	12	MK 4
B10146.0	–	46.00	323.0	163.0	12	MK 4
B10147.0	–	47.00	323.0	163.0	12	MK 4
B10148.0	–	48.00	334.0	174.0	12	MK 4
B10150.0	–	50.00	334.0	174.0	12	MK 4
B1012	2"	50.80	334.0	174.0	12	MK 4



B121



Escariador HSS de Mango Cónico

Diseñado para realinear agujeros en grandes fabricaciones, donde se unen dos o más piezas, antes de atornillarlas o remacharlas. El pequeño diámetro del piloto del cono de relación 1 a 10 simplifica la necesidad de ubicar y alinear la herramienta en agujeros pretaladrados. Adecuado para escariado en muchos materiales.

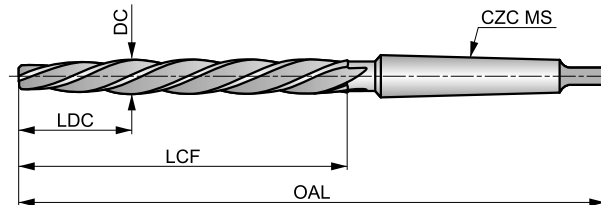

HSS	Bright ST	DIN 311
R		k11

Grupo de Material de la pieza adecuado y condiciones de velocidad de corte iniciales (m/min) y código de avance alfabético. Tablas con avance por revolución a partir de la pag.251.

P1.1 ■ 15 C	P1.2 ■ 16 C	P1.3 ■ 17 C	P2.1 ■ 13 C	P2.2 ■ 11 C	P2.3 ▣ 10 B	P3.1 ■ 7 B	P3.2 ■ 6 B	P3.3 ▣ 5 B	P4.1 ■ 4 B	P4.2 ▣ 4 B	P4.3 ▣ 3 A	K1.1 ■ 14 E	K1.2 ■ 10 D
K1.3 ▣ 8 D	K2.1 ■ 12 C	K2.2 ■ 10 C	K2.3 ▣ 8 C	K3.1 ▣ 11 C	K3.2 ▣ 8 C	N1.1 ▣ 23 F	N1.2 ■ 17 F	N1.3 ■ 9 F	N2.1 ▣ 21 E	N2.2 ■ 18 E	N2.3 ▣ 14 E	N3.1 ■ 34 D	N3.2 ■ 20 E
N3.3 ▣ 10 D	N4.1 ▣ 21 B												

Conicidad 1:10 (LDC).

Producto	DC (mm)	OAL (mm)	LCF (mm)	LDC (mm)	NOF	CZC MS
B12110.0	10.00	171.0	95.0	30.00	4	MK 1
B12111.0	11.00	176.0	100.0	33.00	4	MK 1
B12112.0	12.00	199.0	105.0	39.00	4	MK 2
B12113.0	13.00	199.0	105.0	39.00	4	MK 2
B12114.0	14.00	209.0	115.0	42.00	4	MK 2
B12115.0	15.00	219.0	125.0	45.00	4	MK 2
B12116.0	16.00	229.0	135.0	48.00	4	MK 2
B12117.0	17.00	251.0	135.0	51.00	4	MK 3
B12118.0	18.00	261.0	145.0	58.00	4	MK 3
B12119.0	19.00	261.0	145.0	58.00	4	MK 3
B12120.0	20.00	271.0	155.0	62.00	4	MK 3
B12121.0	21.00	271.0	155.0	62.00	4	MK 3
B12122.0	22.00	281.0	165.0	66.00	4	MK 3
B12123.0	23.00	281.0	165.0	66.00	4	MK 3
B12124.0	24.00	296.0	180.0	72.00	4	MK 3
B12125.0	25.00	296.0	180.0	72.00	4	MK 3
B12126.0	26.00	296.0	180.0	72.00	4	MK 3
B12130.0	30.00	311.0	195.0	78.00	5	MK 3



B954



Escariador de Máquina HSS-E para Pasadores Cónicos, Conicidad 1:50

Se consigue un escariado suave con precisión y rendimiento mejorados mediante el diseño especial con gran ángulo de hélice a izquierda y el corte a derecha. Diseñado para terminar agujeros para alojar pasadores cónicos métricos de proporción estándar de 1 a 50. Adecuado para escariar en muchos materiales.

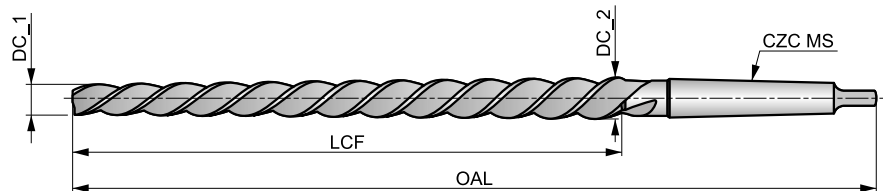

HSS-E	Bright	DIN 2180
R		1:50

Grupo de Material de la pieza adecuado y condiciones de velocidad de corte iniciales (m/min) y código de avance alfabético. Tablas con avance por revolución a partir de la pag.251.

P1.1 ■ 10 B	P1.2 ■ 12 B	P1.3 ■ 13 B	P2.1 ■ 9 B	P2.2 ■ 8 B	P2.3 ▣ 6 A	P3.1 ■ 7 A	P3.2 ■ 6 A	P3.3 ▣ 3 A	P4.1 ■ 4 A	P4.2 ▣ 3 A	P4.3 ▣ 2 A	M1.1 ▣ 11 C	M1.2 ▣ 10 B
M2.1 ▣ 9 B	M2.2 ▣ 8 B	K1.1 ■ 10 C	K1.2 ■ 6 B	K1.3 ▣ 4 B	K2.1 ■ 8 A	K2.2 ■ 6 A	K2.3 ▣ 4 A	K3.1 ■ 11 A	K3.2 ▣ 8 A	N1.1 ▣ 14 F	N1.2 ■ 12 F	N1.3 ■ 9 F	N2.1 ■ 16 E
N2.2 ■ 14 E	N2.3 ▣ 10 E	N3.1 ■ 22	N3.2 ■ 14 E	N3.3 ▣ 6	N4.1 ▣ 22 B								

Producto	nom d	DC_1	DC_2	OAL	LCF	NOF	CZC MS
		(mm)	(mm)	(mm)	(mm)		
B9545.0	5.0	4.90	6.36	155.0	73.0	3	MK 1
B9546.0	6.0	5.90	8.00	187.0	105.0	3	MK 1
B9548.0	8.0	7.90	10.80	227.0	145.0	3	MK 1
B95410.0	10.0	9.90	13.40	257.0	175.0	3	MK 1
B95412.0	12.0	11.80	16.00	315.0	210.0	3	MK 2
B95413.0	13.0	12.86	16.74	295.0	194.0	3	MK 2
B95414.0	14.0	13.86	17.74	295.0	194.0	3	MK 2
B95416.0	16.0	15.80	20.40	335.0	230.0	3	MK 2
B95420.0	20.0	19.80	24.80	377.0	250.0	3	MK 3
B95425.0	25.0	24.70	30.70	427.0	300.0	3	MK 3
B95430.0	30.0	29.70	36.10	475.0	320.0	4	MK 4



B955



Escariador Hueco HSS-E, Tolerancia H7, Acabado Brillante/Templado al Vapor

Escariadores huecos para ser montados en un eje portaescariador. La hélice rectificada con precisión a izquierda y la acción de corte a derecha garantizan un escariado suave. Con chafán guía a 45 ° para una ubicación precisa y centrado en el agujero, para mejorar el rendimiento y la calidad superficial. Adecuado para escariar en muchos materiales.

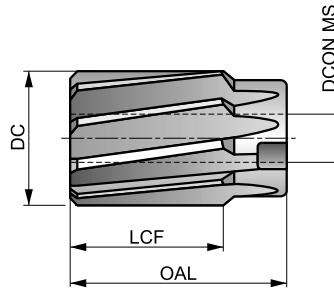

HSS-E	Bright ST	DIN 219
R	B	H7

Grupo de Material de la pieza adecuado y condiciones de velocidad de corte iniciales (m/min) y código de avance alfabético. Tablas con avance por revolución a partir de la pag.251.

P1.1 ■ 15 C	P1.2 ■ 16 C	P1.3 ■ 17 C	P2.1 ■ 13 C	P2.2 ■ 11 C	P2.3 ▧ 10 B	P3.1 ■ 7 B	P3.2 ■ 6 B	P3.3 ▧ 5 B	P4.1 ■ 4 B	P4.2 ▧ 4 B	P4.3 ▧ 3 A	M1.1 ▧ 11 C	M1.2 ▧ 10 B
M2.1 ▧ 9 B	K1.1 ■ 10 E	K1.2 ■ 8 D	K1.3 ▧ 7 D	K2.1 ■ 10 C	K2.2 ■ 9 C	K2.3 ▧ 6 C	K3.1 ▧ 10 C	K3.2 ▧ 7 C	N1.1 ▧ 17 F	N1.2 ■ 17 F	N1.3 ■ 10 F	N2.1 ▧ 23 E	N2.2 ■ 21 E
N2.3 ■ 13 E	N3.1 ■ 34 D	N3.2 ■ 20 E	N3.3 ▧ 10 D	N4.1 ▧ 24 C									

Producto	DC (mm)	OAL (mm)	LCF (mm)	NOF	DCON MS (mm)
B95525.0	25.00	45.0	32.0	8	13.00
B95526.0	26.00	45.0	32.0	8	13.00
B95527.0	27.00	45.0	32.0	8	13.00
B95528.0	28.00	45.0	32.0	8	13.00
B95529.0	29.00	45.0	32.0	8	13.00
B95530.0	30.00	45.0	32.0	8	13.00
B95531.0	31.00	50.0	36.0	10	16.00
B95532.0	32.00	50.0	36.0	10	16.00
B95534.0	34.00	50.0	36.0	10	16.00
B95535.0	35.00	50.0	36.0	10	16.00
B95536.0	36.00	56.0	40.0	10	19.00
B95537.0	37.00	56.0	40.0	10	19.00
B95538.0	38.00	56.0	40.0	10	19.00
B95540.0	40.00	56.0	40.0	10	19.00

Producto	DC (mm)	OAL (mm)	LCF (mm)	NOF	DCON MS (mm)
B95542.0	42.00	56.0	40.0	10	19.00
B95544.0	44.00	63.0	45.0	12	22.00
B95545.0	45.00	63.0	45.0	12	22.00
B95548.0	48.00	63.0	45.0	12	22.00
B95550.0	50.00	63.0	45.0	12	22.00
B95552.0	52.00	71.0	50.0	12	27.00
B95555.0	55.00	71.0	50.0	12	27.00
B95558.0	58.00	71.0	50.0	12	27.00
B95560.0	60.00	71.0	50.0	12	27.00
B95565.0	65.00	80.0	56.0	14	32.00
B95570.0	70.00	80.0	56.0	14	32.00
B95575.0	75.00	90.0	63.0	14	40.00
B95580.0	80.00	90.0	63.0	14	40.00



B956



Portaescariador Mango Cónico, para Escariador Hueco B955

Eje portaescariador para montar escariadores huecos en máquinas. Tiene mango cónico para sujetarlo directamente en el husillo de la máquina. Para obtener piezas de repuesto del eje (destornilladores, tuercas y arandelas) consulte la gama B957 de Dormer para conocer la disponibilidad.

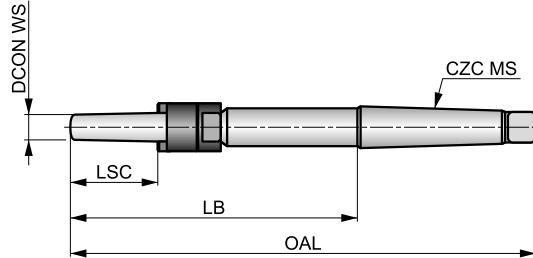

HSS-E



DIN 217



Producto	DCON WS (mm)	OAL (mm)	LSC (mm)	LB (mm)	CZC MS
B95613.0	13.00	250.0	45	151.00	MK 3
B95616.0	16.00	261.0	50	162.00	MK 3
B95619.0	19.00	298.0	56	174.00	MK 4
B95622.0	22.00	312.0	63	188.00	MK 4
B95627.0	27.00	359.0	71	203.00	MK 5
B95632.0	32.00	376.0	80	220.00	MK 5
B95640.0	40.00	396.0	90	240.00	MK 5



B957

DORMER



Accesorios para Portaescariador para Escariador Hueco B956

La gama B957 de repuestos para ejes B956 consta de destornilladores, tuercas y arandelas. Se pueden comprar individualmente por tamaño, lo que garantiza un uso continuo de forma segura. Los destornilladores, tuercas y arandelas B957 se fabrican según los estándares requeridos.

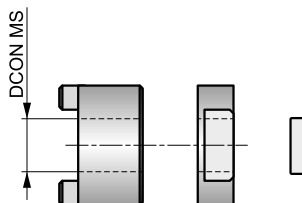

Producto	Nr.	DCON MS
		(mm)
B957N3DRIVER	3	13.00
B957N3NUT	3	—
B957N3WASHER	3	—
B957N4DRIVER	4	16.00
B957N4NUT	4	—
B957N4WASHER	4	—
B957N5DRIVER	5	19.00
B957N5NUT	5	—
B957N5WASHER	5	—
B957N6DRIVER	6	22.00
B957N6NUT	6	—
B957N6WASHER	6	—
B957N7DRIVER	7	27.00
B957N7NUT	7	—
B957N7WASHER	7	—
B957N8DRIVER	8	32.00
B957N8NUT	8	—
B957N8WASHER	8	—
B957N9DRIVER	9	40.00
B957N9NUT	9	—
B957N9WASHER	9	—



G400



Avellanador de Metal Duro a 90°, Mango Cilíndrico, Acabado Brillante

Avellanador de alto rendimiento a 90° con acabado brillante, diseñado para uso en máquinas CNC donde se requiere alta productividad y calidad. Puede utilizarse para aachafanar agujeros en materiales duros y abrasivos. El ángulo de 90° está diseñado para avellanar agujeros para tornillos estándar con cabezas de 90°.

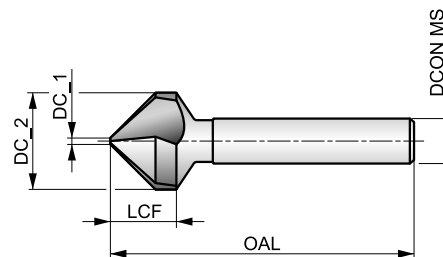

HM	Bright	DIN 335C
R	90°	

Grupo de Material de la pieza adecuado y condiciones de velocidad de corte iniciales (m/min) y código de avance alfabético. Tablas con avance por revolución a partir de la pag.251.

P1.1 ■ 64 E	P1.2 ■ 72 E	P1.3 ■ 74 E	P2.1 ■ 55 E	P2.2 ■ 48 D	P2.3 ■ 43 B	P3.1 ■ 45 D	P3.2 ■ 36 D	P3.3 ■ 30 B	P4.1 ■ 26 D	P4.2 ■ 23 B	P4.3 ■ 18 A	M1.1 ■ 24 C	M1.2 ■ 21 C
M2.1 ■ 22 C	M2.2 ▧ 18 C	M2.3 ▧ 15 B	M3.1 ■ 20 B	M3.2 ▧ 17 B	M3.3 ▧ 15 B	M4.1 ▧ 15 A	M4.2 ▧ 13 A	K1.1 ■ 45 F	K1.2 ■ 33 D	K1.3 ■ 25 D	K2.1 ■ 46 C	K2.2 ■ 37 C	K2.3 ▧ 30 C
K3.1 ■ 41 C	K3.2 ■ 31 C	K3.3 ▧ 25 C	K4.1 ■ 38 C	K4.2 ■ 28 C	K4.3 ■ 21 C	K4.4 ▧ 18 C	K4.5 ▧ 15 C	K5.1 ■ 43 C	K5.2 ■ 32 C	K5.3 ■ 25 C	N1.1 ▧ 75 G	N1.2 ■ 55 G	N1.3 ■ 40 F
N2.1 ■ 40 F	N2.2 ■ 36 F	N2.3 ■ 26 F	N3.1 ■ 42 F	N3.2 ■ 25 F	N3.3 ▧ 13 D	N4.3 ■ 17 E	S1.1 ■ 12 C	S1.2 ■ 10 A	S1.3 ▧ 9 A	S2.1 ■ 8 B	S2.2 ▧ 7 A	S3.1 ■ 6 B	S3.2 ▧ 5 A
S4.1 ■ 5 B	S4.2 ▧ 4 A	H1.1 ■ 12 A	H2.1 ■ 7 A	H2.2 ▧ 6 B	H3.1 ■ 8 A	H3.2 ▧ 7 B	H4.1 ■ 5 A	H4.2 ▧ 4 B					

DCON MS tolerancia h6.

Producto	DC_2 (mm)	DC_1 (mm)	LCF (mm)	OAL (mm)	DCON MS (mm)	NOF
G4006.3	6.30	1.50	5.0	45.0	5.00	3
G4008.3	8.30	2.00	6.0	50.0	6.00	3
G40010.4	10.40	2.50	7.1	50.0	6.00	3
G40012.4	12.40	2.80	8.0	56.0	8.00	3
G40016.5	16.50	3.20	10.0	60.0	10.00	3
G40020.5	20.50	3.50	12.5	63.0	10.00	3
G40025.0	25.00	3.80	15.0	67.0	10.00	3
G40031.0	31.00	4.20	18.0	71.0	12.00	3



G135



Avellanador a 60°, Mango Cilíndrico, Acabado Brillante

Con ángulo de 60° para achaflanar agujeros para tornillos especiales y eliminar rebabas de agujeros taladrados en diámetros de hasta 25,0 mm. Para uso en operaciones manuales y en máquinas. Adecuado para achaflanar agujeros en muchos materiales.

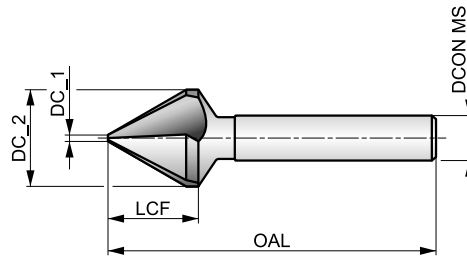

HSS	Bright	DIN 334C
R	60°	

Grupo de Material de la pieza adecuado y condiciones de velocidad de corte iniciales (m/min) y código de avance alfabético. Tablas con avance por revolución a partir de la pag.251.

P1.1 ■ 23 E	P1.2 ■ 26 E	P1.3 ■ 27 E	P2.1 ■ 20 E	P2.2 ■ 18 D	P2.3 ▧ 16 B	P3.1 ■ 16 D	P3.2 ▧ 13 D	P3.3 ▧ 11 B	P4.1 ■ 10 D	P4.2 ▧ 8 B	M1.1 ▧ 8 C	M1.2 ▧ 6 C	M2.1 ▧ 7 C
M2.2 ▧ 6 C	K1.1 ▧ 20 F	K1.2 ▧ 15 D	K2.1 ▧ 21 C	K2.2 ▧ 17 C	K3.1 ▧ 18 C	K3.2 ▧ 14 C	K5.1 ▧ 19 C	K5.2 ▧ 15 C	N1.1 ▧ 40 G	N1.2 ■ 30 G	N1.3 ▧ 20 F	N2.1 ■ 20 F	N2.2 ▧ 18 F
N3.1 ■ 21 F	N3.2 ■ 12 F	N3.3 ▧ 6 D	N4.1 ▧ 40 G	N4.2 ▧ 35 G									

DCON MS tolerancia h9.

Producto	DC_2 (mm)	DC_1 (mm)	LCF (mm)	OAL (mm)	DCON MS (mm)	NOF
G1356.3	6.30	1.60	6.8	45.0	5.00	3
G1358.0	8.00	2.00	8.5	50.0	6.00	3
G13510.0	10.00	2.50	7.6	50.0	6.00	3
G13512.5	12.50	3.20	11.7	56.0	8.00	3
G13516.0	16.00	4.00	14.5	63.0	10.00	3
G13520.0	20.00	5.00	17.5	67.0	10.00	3
G13525.0	25.00	6.30	20.5	71.0	10.00	3



G335



Avellanador HSS a 60°, Mango Cilíndrico, con Recubrimiento TiN

Para avellanar agujeros biselados a 60° para alojar tornillos especiales y eliminar las rebabas de los agujeros perforados. El recubrimiento de TiN mejora el rendimiento y prolonga la vida útil de la herramienta. Herramienta versátil que se puede utilizar tanto en aplicaciones manuales como en máquinas. Adecuado para biselar agujeros en muchos materiales.

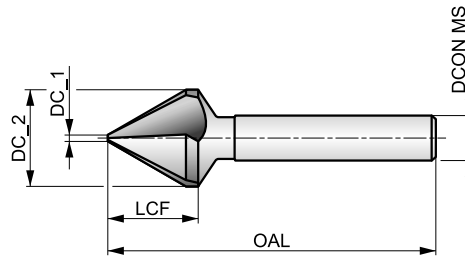

HSS	TiN	DIN 334C
R	60°	

Grupo de Material de la pieza adecuado y condiciones de velocidad de corte iniciales (m/min) y código de avance alfabético. Tablas con avance por revolución a partir de la pag.251.

P1.1 ■ 33 E	P1.2 ■ 37 E	P1.3 ■ 38 E	P2.1 ■ 28 E	P2.2 ■ 25 D	P2.3 ■ 22 B	P3.1 ■ 23 D	P3.2 ■ 18 D	P3.3 ■ 15 B	P4.1 ■ 13 D	P4.2 ■ 11 B	P4.3 ■ 9 B	M1.1 ■ 10 C	M1.2 ■ 8 C
M2.1 ■ 19 C	M3.1 ■ 8 B	K1.1 ■ 34 F	K1.2 ■ 25 D	K1.3 ■ 19 D	K2.1 ■ 35 C	K2.2 ■ 28 C	K2.3 ■ 23 C	K3.1 ■ 31 C	K3.2 ■ 24 C	K3.3 ■ 19 C	K4.1 ■ 29 C	K4.2 ■ 22 C	K4.3 ■ 16 C
K5.1 ■ 32 C	K5.2 ■ 24 C	K5.3 ■ 19 C	N1.1 ■ 53 G	N1.2 ■ 40 G	N1.3 ■ 27 F	N2.1 ■ 27 F	N2.2 ■ 24 F	N2.3 ■ 17 F	N3.1 ■ 28 F	N3.2 ■ 16 F	N3.3 ■ 8 D	N4.1 ■ 58 G	N4.2 ■ 50 G

DCON MS tolerancia h9.

Producto	DC_2 (mm)	DC_1 (mm)	LCF (mm)	OAL (mm)	DCON MS (mm)	NOF
G3356.3	6.30	1.60	6.8	45.0	5.00	3
G3358.0	8.00	2.00	8.5	50.0	6.00	3
G33510.0	10.00	2.50	7.6	50.0	6.00	3
G33512.5	12.50	3.20	11.7	56.0	8.00	3
G33516.0	16.00	4.00	14.5	63.0	10.00	3
G33520.0	20.00	5.00	17.5	67.0	10.00	3
G33525.0	25.00	6.30	20.5	71.0	10.00	3



G137



Avellanador HSS a 60°, Mango Cónico, Acabado Brillante

Avellanadores con acabado brillante y ángulo de 60° para achaflanar agujeros para tornillos especiales y eliminar rebabas de agujeros taladrados. El diseño de mango cónico permite que la herramienta se pueda fijar directamente en el husillo de la máquina. Adecuado para achaflanar agujeros en muchos materiales.

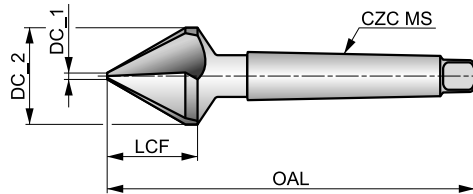

HSS	Bright	DIN 334D
R	60°	

Grupo de Material de la pieza adecuado y condiciones de velocidad de corte iniciales (m/min) y código de avance alfabético. Tablas con avance por revolución a partir de la pag.251.

P1.1 ■ 23 E	P1.2 ■ 26 E	P1.3 ■ 27 E	P2.1 ■ 20 E	P2.2 ■ 18 D	P2.3 ▣ 16 B	P3.1 ■ 16 D	P3.2 ▣ 13 D	P3.3 ▣ 11 B	P4.1 ■ 10 D	P4.2 ▣ 8 B	M1.1 ▣ 8 C	M1.2 ▣ 6 C	M2.1 ▣ 7 C
M2.2 ▣ 6 C	K1.1 ▣ 20 F	K1.2 ▣ 15 D	K2.1 ▣ 21 C	K2.2 ▣ 17 C	K3.1 ▣ 18 C	K3.2 ▣ 14 C	K5.1 ▣ 19 C	K5.2 ▣ 15 C	N1.1 ▣ 40 G	N1.2 ■ 30 G	N1.3 ▣ 20 F	N2.1 ■ 20 F	N2.2 ▣ 18 F
N3.1 ■ 21 F	N3.2 ■ 12 F	N3.3 ▣ 6 D	N4.1 ▣ 40 G	N4.2 ▣ 35 G									

Producto	DC_2 (mm)	DC_1 (mm)	LCF (mm)	OAL (mm)	CZC MS	NOF
G13716.0	16.00	4.00	14.5	90.0	MK 1	3
G13720.0	20.00	5.00	17.5	106.0	MK 2	3
G13725.0	25.00	6.30	20.0	112.0	MK 2	3
G13731.5	31.50	10.00	23.0	118.0	MK 2	3
G13740.0	40.00	12.50	28.5	150.0	MK 3	3
G13750.0	50.00	16.00	36.0	160.0	MK 3	3
G13763.0	63.00	20.00	43.0	190.0	MK 4	3
G13780.0	80.00	25.00	54.0	200.0	MK 4	3



G154



Avellanador HSS a 82°, Mango Cilíndrico, Acabado Brillante

Avellanador de 82° para tornillos de cabeza plana y para achaflanar agujeros. Herramienta versátil para uso tanto en máquinas como en taladros manuales. Adecuado para achaflanar agujeros en la mayoría de materiales.

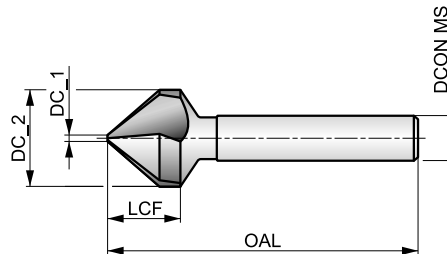

HSS	Bright	DIN 335C
R	82°	

Grupo de Material de la pieza adecuado y condiciones de velocidad de corte iniciales (m/min) y código de avance alfabético. Tablas con avance por revolución a partir de la pag.251.

P1.1 ■ 23 E	P1.2 ■ 26 E	P1.3 ■ 27 E	P2.1 ■ 20 E	P2.2 ■ 18 D	P2.3 ■ 16 B	P3.1 ■ 16 D	P3.2 ■ 13 D	P3.3 ■ 11 B	P4.1 ■ 10 D	P4.2 ■ 8 B	M1.1 ■ 8 C	M1.2 ■ 6 C	M2.1 ■ 7 C
M2.2 ■ 16 C	K1.1 ■ 20 F	K1.2 ■ 15 D	K2.1 ■ 21 C	K2.2 ■ 17 C	K3.1 ■ 18 C	K3.2 ■ 14 C	K5.1 ■ 14 C	K5.2 ■ 10 C	N1.1 ■ 40 G	N1.2 ■ 30 G	N1.3 ■ 20 F	N2.1 ■ 20 F	N2.2 ■ 18 F
N3.1 ■ 21 F	N3.2 ■ 12 F	N3.3 ■ 6 D	N4.1 ■ 40 G	N4.2 ■ 35 G									

DCON MS tolerancia h9.

Producto	DC_2 (mm)	DC_1 (mm)	LCF (mm)	OAL (mm)	DCON MS (mm)	NOF
G1546.3	6.30	1.50	5.5	45.0	5.00	3
G1548.3	8.30	2.00	6.5	50.0	6.00	3
G15410.4	10.40	2.50	7.6	50.0	6.00	3
G15412.4	12.40	2.80	8.5	56.0	8.00	3
G15416.5	16.50	3.20	10.5	60.0	10.00	3
G15420.5	20.50	3.50	13.0	63.0	10.00	3
G15425.0	25.00	3.80	15.5	67.0	10.00	3



G129

DORMER



Avellanador HSS a 90°, con un Solo Canal, Mango Cilíndrico, con Acabado Brillante

Avellanador de 90° diseñado para achaflanar y para eliminar rebabas en agujeros taladrados. El diseño de un solo filo reduce vibraciones para proporcionar una operación de achaflanado suave. Adecuado para achaflanar agujeros en aceros de bajo contenido en carbono y materiales no féreos de resistencia media, como el aluminio.

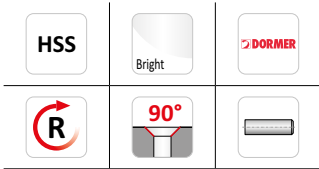
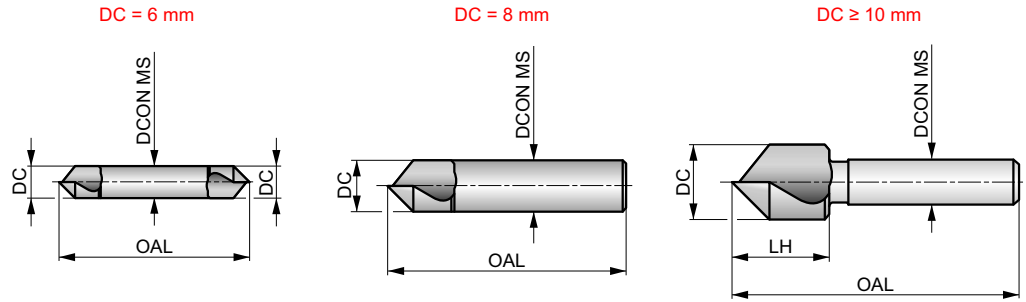

Grupo de Material de la pieza adecuado y condiciones de velocidad de corte iniciales (m/min) y código de avance alfabético. Tablas con avance por revolución a partir de la pag.251.

P1.1 ■ 21 D	P1.2 ■ 24 D	P1.3 ■ 25 D	P2.1 ■ 18 D	P2.2 ■ 16 C	P2.3 ▣ 14 A	P3.1 ■ 13 B	P3.2 ▣ 11 B	M1.1 ▣ 8 B	M1.2 ▣ 6 B	M2.1 ▣ 7 B	K1.1 ▣ 18 D	K1.2 ▣ 13 C	K2.1 ▣ 19 A
K2.2 ▣ 15 A	K3.1 ▣ 16 A	K3.2 ▣ 12 A	N1.1 ■ 34 D	N1.2 ■ 25 D	N1.3 ▣ 16 C	N2.1 ▣ 16 C	N2.2 ▣ 14 C	N3.1 ■ 17 C	N3.2 ■ 9 C	N3.3 ▣ 5 B	N4.1 ▣ 35 D	N4.2 ▣ 30 D	

DCON MS tolerancia h9.

Producto	DC (mm)	LH (mm)	OAL (mm)	DCON MS (mm)	NOF
G1296.0	6.00	—	45.0	6.00	1
G1298.0	8.00	—	50.0	8.00	1
G12910.0	10.00	17.0	49.0	8.00	1
G12912.5	12.50	17.0	49.0	8.00	1
G12916.0	16.00	20.0	56.0	10.00	1
G12920.0	20.00	24.0	60.0	10.00	1
G12925.0	25.00	25.0	75.0	12.00	1
G12931.5	31.50	29.0	80.0	12.00	1



G149



Avellanador HSS-E a 90°, con Agujero Pasante, Mango Cilíndrico, con Acabado Brillante

Avellanador de 90° diseñado para achaflanar agujeros y para eliminar rebabas en agujeros taladrados. El diseño especial de agujero cruzado dirige la viruta lejos del filo de corte para ofrecer una operación de achaflanado suave. Adecuado para achaflanar agujeros en la mayoría de materiales.

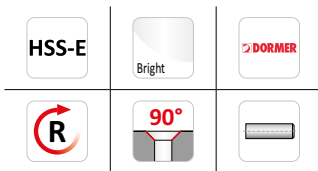
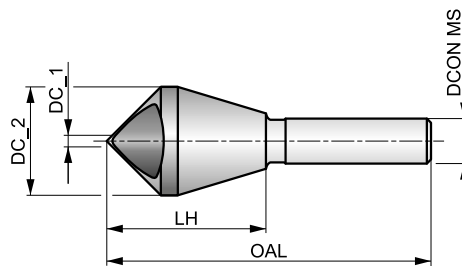

Grupo de Material de la pieza adecuado y condiciones de velocidad de corte iniciales (m/min) y código de avance alfabético. Tablas con avance por revolución a partir de la pag.251.

P1.1 ▣21 D	P1.2 ▣24 D	P1.3 ▣25 D	P2.1 ▣18 D	P2.2 ▣16 C	P2.3 ▣14 A	P3.1 ▣16 B	P3.2 ▣13 B	M1.1 ▣8 B	M1.2 ▣6 B	M2.1 ▣7 B	K1.1 ▣18 D	K2.1 ▣19 A	K3.1 ▣16 A
K5.1 ▣14 A	N1.1 ▣34 D	N1.2 ▣25 D	N1.3 ▣16 C	N2.1 ▣16 C	N2.2 ▣14 C	N3.1 ▣17 C	N3.2 ▣9 C	N3.3 ▣5 B	N4.1 ▣17 D	N4.2 ▣5 D			

Producto	DC_2 (mm)	DC_1 (mm)	LH (mm)	OAL (mm)	DCON MS (mm)	DC (mm)	NOF
G1495	5.00	2.00	19.0	45.0	6.00	10.00	1
G14910	10.00	5.00	23.0	48.0	8.00	14.00	1
G14915	15.00	10.00	34.0	65.0	10.00	21.00	1
G14920	20.00	15.00	43.0	84.0	12.00	28.00	1
G14925	25.00	20.00	48.0	102.0	15.00	35.00	1
G14930	30.00	25.00	61.0	115.0	15.00	44.00	1
G14935	35.00	30.00	65.0	127.0	15.00	48.00	1
G14940	40.00	35.00	66.0	136.0	15.00	53.00	1
G14950	50.00	40.00	85.0	166.0	20.00	60.00	1



G136



Avellanador HSS a 90°, Mango Cilíndrico, con Acabado Brillante

Avellanador de 90° diseñado para achaflanar agujeros y para eliminar rebabas en agujeros taladrados. El mango reducido permite avellanados de mayor diámetro en portaherramientas y portabrocas estándar. Herramienta versátil, que se puede utilizar en aplicaciones manuales y en máquinas. Adecuado para achaflanar agujeros en la mayoría de materiales.

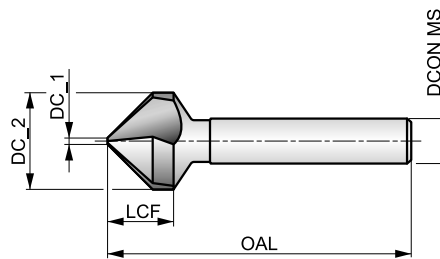

HSS	Bright	DIN 335C
R	90°	

Grupo de Material de la pieza adecuado y condiciones de velocidad de corte iniciales (m/min) y código de avance alfabético. Tablas con avance por revolución a partir de la pag.251.

P1.1 ■ 23 E	P1.2 ■ 26 E	P1.3 ■ 27 E	P2.1 ■ 20 E	P2.2 ■ 18 D	P2.3 ▣ 16 B	P3.1 ■ 16 D	P3.2 ■ 13 D	P3.3 ▣ 11 B	P4.1 ■ 10 D	P4.2 ▣ 8 B	M1.1 ▣ 8 C	M1.2 ▣ 6 C	M2.1 ▣ 7 C
M2.2 ▣ 16 C	K1.1 ▣ 20 F	K1.2 ▣ 15 D	K2.1 ▣ 21 C	K2.2 ▣ 17 C	K3.1 ▣ 18 C	K3.2 ▣ 14 C	K5.1 ▣ 19 C	K5.2 ▣ 15 C	N1.1 ▣ 40 G	N1.2 ■ 30 G	N1.3 ▣ 20 F	N2.1 ■ 20 F	N2.2 ▣ 18 F
N3.1 ■ 21 F	N3.2 ■ 12 F	N3.3 ▣ 6 D	N4.1 ▣ 40 G	N4.2 ▣ 35 G									

DCON MS tolerancia h9.

Los productos de esta serie también están disponibles en forma de Set. Por favor, vea G236.

Producto	DC_2 (mm)	DC_1 (mm)	LCF (mm)	OAL (mm)	DCON MS (mm)	NOF
G1364.3	4.30	1.30	4.0	40.0	4.00	3
G1365.0	5.00	1.50	4.5	40.0	4.00	3
G1365.3	5.30	1.50	4.5	40.0	4.00	3
G1365.8	5.80	1.50	5.0	45.0	5.00	3
G1366.0	6.00	1.50	5.0	45.0	5.00	3
G1366.3	6.30	1.50	5.5	45.0	5.00	3
G1367.0	7.00	1.80	5.5	50.0	6.00	3
G1367.3	7.30	1.80	6.1	50.0	6.00	3
G1368.0	8.00	2.00	6.1	50.0	6.00	3
G1368.3	8.30	2.00	6.5	50.0	6.00	3
G1369.4	9.40	2.20	7.2	50.0	6.00	3
G13610.0	10.00	2.50	7.6	50.0	6.00	3
G13610.4	10.40	2.50	7.6	50.0	6.00	3

Producto	DC_2 (mm)	DC_1 (mm)	LCF (mm)	OAL (mm)	DCON MS (mm)	NOF
G13611.5	11.50	2.80	8.0	56.0	8.00	3
G13612.4	12.40	2.80	8.5	56.0	8.00	3
G13613.4	13.40	2.90	9.0	56.0	8.00	3
G13615.0	15.00	3.20	9.5	60.0	10.00	3
G13616.5	16.50	3.20	10.5	60.0	10.00	3
G13619.0	19.00	3.50	11.7	63.0	10.00	3
G13620.5	20.50	3.50	13.0	63.0	10.00	3
G13623.0	23.00	3.80	13.7	67.0	10.00	3
G13625.0	25.00	3.80	15.5	67.0	10.00	3
G13626.0	26.00	3.80	15.5	67.0	10.00	3
G13628.0	28.00	4.00	16.5	71.0	12.00	3
G13630.0	30.00	4.20	18.5	71.0	12.00	3
G13631.0	31.00	4.20	18.5	71.0	12.00	3



G560



Avellanador HSS a 90°, Mango Cilíndrico, con Recubrimiento TiAlN

Avellanador de 90° diseñado para achaflanar agujeros para tornillos estándar y para eliminar rebabas en agujeros taladrados. El mango reducido permite avellanados de mayor diámetro en portaherramientas y portabrocas estándar. Herramienta versátil, que se puede utilizar en aplicaciones manuales y en máquinas. El recubrimiento TiAlN mejora el rendimiento y prolonga la vida útil de la herramienta.

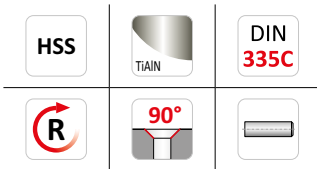
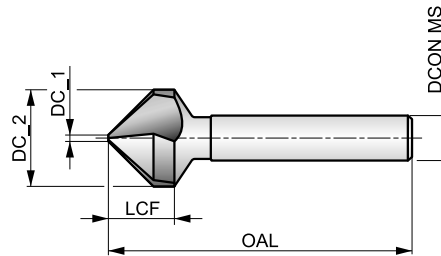

Grupo de Material de la pieza adecuado y condiciones de velocidad de corte iniciales (m/min) y código de avance alfabético. Tablas con avance por revolución a partir de la pag.251.

P1.1 ■ 40 E	P1.2 ■ 45 E	P1.3 ■ 46 E	P2.1 ■ 34 E	P2.2 ■ 30 D	P2.3 ■ 27 B	P3.1 ■ 28 D	P3.2 ■ 22 D	P3.3 ■ 19 B	P4.1 ■ 16 D	P4.2 ■ 14 B	P4.3 ▧11 B	M1.1 ▧11 C	M1.2 ▧9 C
M2.1 ▧10 C	M2.2 ▧9 C	M2.3 ▧8 B	K1.1 ■ 41 F	K1.2 ■ 30 D	K1.3 ▧23 D	K2.1 ■ 42 C	K2.2 ■ 34 C	K2.3 ▧27 C	K3.1 ■ 37 C	K3.2 ■ 28 C	K3.3 ▧23 C	K4.1 ▧34 C	K4.2 ▧26 C
K4.3 ▧19 C	K5.1 ■ 39 C	K5.2 ■ 29 C	K5.3 ▧23 C	N1.1 ▧60 G	N1.2 ▧45 G	N1.3 ■ 30 F	N2.1 ■ 30 F	N2.2 ■ 27 F	N2.3 ■ 19 F	N3.1 ■ 32 F	N3.2 ■ 18 F	N3.3 ▧9 D	N4.1 ▧62 G
N4.2 ▧155 G													

DCON MS tolerancia h9.

Los productos de esta serie también están disponibles en forma de Set. Por favor, vea G236.

Producto	DC_2 (mm)	DC_1 (mm)	LCF (mm)	OAL (mm)	DCON MS (mm)	NOF
G5606.3	6.30	1.50	5.5	45.0	5.00	3
G5608.0	8.00	2.00	6.1	50.0	6.00	3
G5608.3	8.30	2.00	6.5	50.0	6.00	3
G56010.0	10.00	2.50	7.6	50.0	6.00	3
G56010.4	10.40	2.50	7.6	50.0	6.00	3
G56012.4	12.40	2.80	8.5	56.0	8.00	3
G56016.5	16.50	3.20	10.5	60.0	10.00	3
G56020.5	20.50	3.50	13.0	63.0	10.00	3
G56025.0	25.00	3.80	15.5	67.0	10.00	3
G56031.0	31.00	4.20	18.5	71.0	12.00	3



G106



Avellanador HSS a 90°, Mango a Tres Planos, con Acabado Brillante

Avellanador de 90° diseñado para achaflanar agujeros para tornillos estándar y para eliminar rebabas en agujeros taladrados. El mango con tres planos de apriete mejora el amarre en portabrocas de tres garras. Adecuado para achaflanar agujeros en la mayoría de materiales.

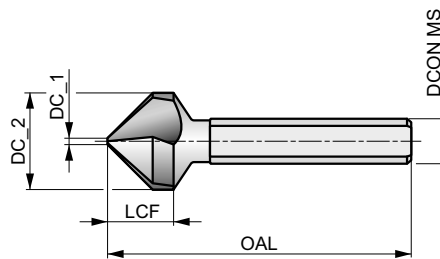

HSS	Bright	DIN 335C
R	90°	

Grupo de Material de la pieza adecuado y condiciones de velocidad de corte iniciales (m/min) y código de avance alfabético. Tablas con avance por revolución a partir de la pag.251.

P1.1 ■ 23 E	P1.2 ■ 26 E	P1.3 ■ 27 E	P2.1 ■ 20 E	P2.2 ■ 18 D	P2.3 ▣ 16 B	P3.1 ■ 16 D	P3.2 ■ 13 D	P3.3 ▣ 11 B	P4.1 ■ 10 D	P4.2 ▣ 8 B	M1.1 ▣ 8 C	M1.2 ▣ 6 C	M2.1 ▣ 7 C
M2.2 ▣ 6 C	K1.1 ■ 20 F	K1.2 ■ 15 D	K2.1 ▣ 21 C	K2.2 ▣ 17 C	K3.1 ▣ 18 C	K3.2 ▣ 14 C	K5.1 ▣ 19 C	K5.2 ▣ 15 C	N1.1 ▣ 40 G	N1.2 ■ 30 G	N1.3 ▣ 20 F	N2.1 ▣ 20 F	N2.2 ▣ 18 F
N3.1 ■ 21 F	N3.2 ▣ 12 F	N3.3 ▣ 6 D	N4.1 ▣ 40 G	N4.2 ▣ 35 G									

DCON MS tolerancia h9.

Los productos de esta serie también están disponibles en forma de Set. Por favor, vea G236.

Producto	DC_2 (mm)	DC_1 (mm)	LCF (mm)	OAL (mm)	DCON MS (mm)	NOF
G1066.3	6.30	1.50	5.6	45.0	5.00	3
G1068.3	8.30	2.00	6.9	50.0	6.00	3
G10610.4	10.40	2.50	7.8	50.0	6.00	3
G10612.4	12.40	2.80	8.6	56.0	8.00	3
G10616.5	16.50	3.20	11.1	60.0	10.00	3
G10620.5	20.50	3.50	12.9	63.0	10.00	3
G10625.0	25.00	3.80	15.7	67.0	10.00	3
G10631.0	31.00	4.20	18.5	71.0	12.00	3
G10634.0	34.00	4.50	19.0	103.0	16.00	3
G10637.0	37.00	4.50	21.2	118.0	16.00	3
G10640.0	40.00	4.50	20.0	118.0	16.00	3
G10650.0	50.00	5.00	23.6	126.0	16.00	3



G506



Avellanador HSS a 90°, Mango a Tres Planos, con Recubrimiento TiAlN

Avellanador de 90° diseñado para achaflanar agujeros para tornillos estándar y para eliminar rebabas en agujeros taladrados. El mango con tres planos de apriete mejora el amarre en portabrocas de tres garras, especialmente en máquinas de mano. El recubrimiento TiAlN prolonga la vida útil de la herramienta. Adecuado para achaflanar agujeros en la mayoría de materiales.

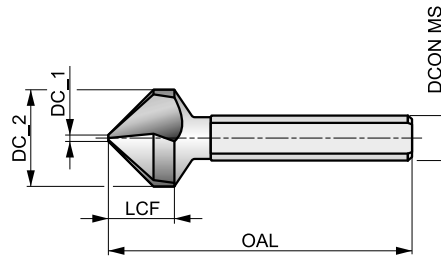

HSS	TiAlN	DIN 335C
R	90°	

Grupo de Material de la pieza adecuado y condiciones de velocidad de corte iniciales (m/min) y código de avance alfabético. Tablas con avance por revolución a partir de la pag.251.

P1.1 ■ 40 E	P1.2 ■ 45 E	P1.3 ■ 46 E	P2.1 ■ 34 E	P2.2 ■ 30 D	P2.3 ■ 27 B	P3.1 ■ 28 D	P3.2 ■ 22 D	P3.3 ■ 19 B	P4.1 ■ 16 D	P4.2 ■ 14 B	P4.3 ▣ 11 B	M1.1 ▣ 11 C	M1.2 ▣ 9 C
M2.1 ▣ 10 C	M2.2 ▣ 9 C	M2.3 ▣ 8 B	K1.1 ■ 41 F	K1.2 ■ 30 D	K1.3 ▣ 23 D	K2.1 ■ 42 C	K2.2 ■ 34 C	K2.3 ▣ 27 C	K3.1 ■ 37 C	K3.2 ■ 28 C	K3.3 ▣ 23 C	K4.1 ▣ 34 C	K4.2 ▣ 26 C
K4.3 ▣ 19 C	K5.1 ■ 39 C	K5.2 ■ 29 C	K5.3 ▣ 23 C	N1.1 ▣ 60 G	N1.2 ▣ 45 G	N1.3 ■ 30 F	N2.1 ■ 30 F	N2.2 ■ 27 F	N2.3 ■ 19 F	N3.1 ■ 32 F	N3.2 ■ 18 F	N3.3 ▣ 9 D	N4.1 ▣ 62 G
N4.2 ▣ 55 G													

DCON MS tolerancia h9.

Los productos de esta serie también están disponibles en forma de Set. Por favor, vea G236.

Producto	DC_2 (mm)	DC_1 (mm)	LCF (mm)	OAL (mm)	DCON MS (mm)	NOF
G5066.3	6.30	1.50	5.6	45.0	5.00	3
G5068.3	8.30	2.00	6.9	50.0	6.00	3
G50610.4	10.40	2.50	7.8	50.0	6.00	3
G50612.4	12.40	2.80	8.6	56.0	8.00	3
G50616.5	16.50	3.20	11.1	60.0	10.00	3
G50620.5	20.50	3.50	12.9	63.0	10.00	3
G50625.0	25.00	3.80	15.7	67.0	10.00	3
G50631.0	31.00	4.20	18.5	71.0	12.00	3
G50634.0	34.00	4.50	19.0	103.0	16.00	3
G50637.0	37.00	4.50	21.2	118.0	16.00	3
G50640.0	40.00	4.50	20.0	118.0	16.00	3
G50650.0	50.00	5.00	23.6	126.0	16.00	3



G142



Avellanador HSS a 90°, Mango Cilíndrico, con Acabado Brillante, para Acero Inoxidable.

Avellanador de 90° diseñado para achaflanar agujeros para tornillos estándar y para eliminar rebabas en agujeros taladrados. Mayor relieve para proporcionar un filo de corte más afilado, lo que mejora el rendimiento al mecanizar materiales pegajosos, como aceros inoxidables y materiales no férreos. Se puede utilizar en aplicaciones manuales y en máquinas.

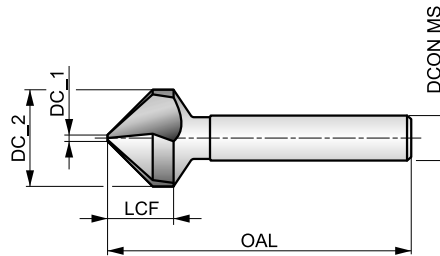

HSS	Bright	DIN 335C
R	90°	

Grupo de Material de la pieza adecuado y condiciones de velocidad de corte iniciales (m/min) y código de avance alfabético. Tablas con avance por revolución a partir de la pag.251.

P1.1 ■ 23 E	P1.2 ■ 26 E	P1.3 ■ 27 E	P2.1 ■ 20 E	P2.2 ■ 18 D	P2.3 ▣ 16 B	P3.1 ■ 16 D	P3.2 ■ 13 D	P3.3 ▣ 11 B	P4.1 ■ 10 D	P4.2 ▣ 8 B	M1.1 ■ 11 C	M1.2 ■ 9 C	M2.1 ■ 10 C
M2.2 ▣ 8 C	M3.1 ■ 7 B	M3.2 ▣ 6 B	M4.1 ▣ 4 A	N1.1 ■ 40 G	N1.2 ■ 30 G	N1.3 ▣ 20 F	N2.1 ▣ 20 F	N2.2 ▣ 18 F	N2.3 ▣ 20 F	N3.1 ■ 34 F	N3.2 ■ 20 F	N3.3 ■ 10 D	N4.1 ■ 40 G
N4.2 ■ 35 G													

DCON MS tolerancia h9.

Producto	DC_2 (mm)	DC_1 (mm)	LCF (mm)	OAL (mm)	DCON MS (mm)	NOF
G1424.8	4.80	1.30	4.5	40.0	4.00	3
G1425.0	5.00	1.50	4.5	40.0	4.00	3
G1426.0	6.00	1.50	5.0	45.0	5.00	3
G1426.3	6.30	1.50	5.5	45.0	5.00	3
G1427.0	7.00	1.80	5.5	50.0	6.00	3
G1427.3	7.30	1.80	6.1	50.0	6.00	3
G1428.0	8.00	2.00	6.1	50.0	6.00	3
G1428.3	8.30	2.00	6.5	50.0	6.00	3
G14210.0	10.00	2.50	7.6	50.0	6.00	3
G14210.4	10.40	2.50	7.6	50.0	6.00	3
G14211.5	11.50	2.80	8.0	56.0	8.00	3
G14212.4	12.40	2.80	8.5	56.0	8.00	3
G14215.0	15.00	3.20	9.5	60.0	10.00	3
G14216.5	16.50	3.20	10.5	60.0	10.00	3
G14219.0	19.00	3.50	11.7	63.0	10.00	3
G14220.5	20.50	3.50	13.0	63.0	10.00	3
G14223.0	23.00	3.80	13.7	67.0	10.00	3
G14225.0	25.00	3.80	15.5	67.0	10.00	3
G14231.0	31.00	4.20	18.5	71.0	12.00	3



G570



Avellanador HSS-E a 90°, Mango Cilíndrico, con Recubrimiento AlTiCN

Avellanador de 90° diseñado para achaflanar agujeros para tornillos estándar y para eliminar rebabas en agujeros taladrados. Se puede utilizar en aplicaciones manuales y en máquinas. Especialmente indicado para achaflanar agujeros en materiales duros y abrasivos. El recubrimiento AlTiCN mejora el rendimiento y prolonga la vida útil de la herramienta.

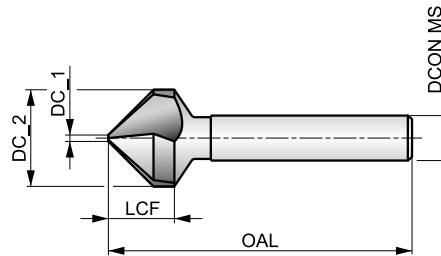

HSS-E	AlTiCN	DIN 335C
R	90°	

Grupo de Material de la pieza adecuado y condiciones de velocidad de corte iniciales (m/min) y código de avance alfabético. Tablas con avance por revolución a partir de la pag.251.

P1.1 ■ 40 E	P1.2 ■ 45 E	P1.3 ■ 46 E	P2.1 ■ 34 E	P2.2 ■ 30 D	P2.3 ■ 27 B	P3.1 ■ 28 D	P3.2 ■ 22 D	P3.3 ■ 19 B	P4.1 ■ 16 D	P4.2 ■ 14 B	P4.3 ■ 11 B	M1.1 ■ 23 C	M1.2 ■ 20 C
M2.1 ■ 21 C	M2.2 ■ 17 C	M2.3 ■ 14 A	M3.1 ■ 14 B	M3.2 ■ 12 B	M3.3 ■ 11 B	M4.1 ■ 15 A	M4.2 ■ 13 A	K1.1 ■ 41 C	K1.2 ■ 30 C	K1.3 ■ 23 C	K2.1 ■ 42 C	K2.2 ■ 34 C	K2.3 ■ 27 C
K3.1 ■ 37 C	K3.2 ■ 28 C	K3.3 ■ 23 C	K4.1 ■ 34 C	K4.2 ■ 26 C	K4.3 ■ 19 C	K5.1 ■ 39 C	K5.2 ■ 29 C	K5.3 ■ 23 C	N1.1 ■ 60 G	N1.2 ■ 45 G	N1.3 ■ 30 F	N2.1 ■ 30 F	N2.2 ■ 27 F
N2.3 ■ 19 F	N3.1 ■ 32 F	N3.2 ■ 18 F	N3.3 ■ 9 D										

DCON MS tolerancia h9.

Producto	DC_2 (mm)	DC_1 (mm)	LCF (mm)	OAL (mm)	DCON MS (mm)	NOF
G5706.3	6.30	1.50	6.5	45.0	5.00	3
G5708.3	8.30	2.00	8.2	50.0	6.00	3
G57010.4	10.40	2.50	9.7	50.0	6.00	3
G57012.4	12.40	2.80	10.6	56.0	8.00	3
G57016.5	16.50	3.20	13.9	60.0	10.00	3
G57020.5	20.50	3.50	17.1	63.0	10.00	3
G57025.0	25.00	3.80	21.4	67.0	10.00	3
G57031.0	31.00	4.20	24.4	71.0	12.00	3



G107



Avellanador HSS-E 90°, con Mango Hexagonal, Acabado Brillante

Avellanador versátil con mango hexagonal que facilita su fijación en adaptadores para destornilladores eléctricos. El avellanador a 90° produce chaflanes en agujeros para tornillos estándar y elimina rebabas en agujeros taladrados. Adecuado para achaflanar agujeros en la mayoría de materiales.

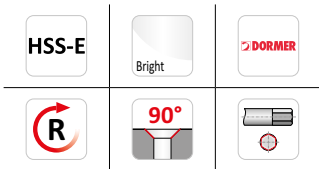
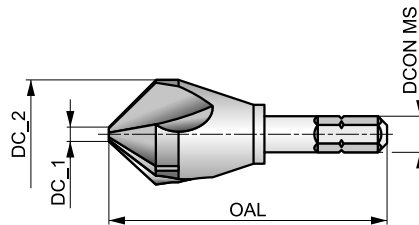

Grupo de Material de la pieza adecuado y condiciones de velocidad de corte iniciales (m/min) y código de avance alfabético. Tablas con avance por revolución a partir de la pag.251.

P1.1 ■ 23 E	P1.2 ■ 26 E	P1.3 ■ 27 E	P2.1 ■ 20 E	P2.2 ■ 18 D	P2.3 ▧ 16 B	P3.1 ■ 16 D	P3.2 ■ 13 D	P3.3 ▧ 11 B	P4.1 ■ 10 D	P4.2 ▧ 8 B	M1.1 ▧ 11 C	M1.2 ▧ 9 C	M2.1 ▧ 10 C
M2.2 ▧ 9 C	M2.3 ▧ 8 B	K1.1 ■ 20 F	K1.2 ▧ 15 D	K2.1 ■ 21 C	K2.2 ▧ 17 C	K3.1 ■ 18 C	K3.2 ▧ 14 C	K4.1 ▧ 15 C	K5.1 ■ 19 C	K5.2 ▧ 15 C	N1.1 ▧ 40 G	N1.2 ■ 30 G	N1.3 ▧ 20 F
N2.1 ▧ 20 F	N2.2 ▧ 18 F	N2.3 ▧ 20 F	N3.1 ■ 21 F	N3.2 ▧ 12 F	N3.3 ▧ 6 D	N4.1 ▧ 40 G	N4.2 ▧ 35 G						

6.35; 1/4" mango hexagonal; DIN 74.

Producto	DC_2 (mm)	DC_1 (mm)	OAL (mm)	DCONMS (inch)	CZC MS	NOF
G1076.3	6.30	1.50	50.0	1/4"	M2-M3	3
G1078.3	8.30	2.00	50.0	1/4"	M4	3
G10710.4	10.40	2.50	50.0	1/4"	M5	3
G10712.4	12.40	2.80	50.0	1/4"	M6	3
G10716.5	16.50	3.20	50.0	1/4"	M8	3
G10720.5	20.50	3.50	50.0	1/4"	M10	3



G600

DORMER



Avellanador HSS a 90°, Mango Cilíndrico Extra Largo, Acabado Brillante

El mango extra largo permite achaflanar agujeros en áreas de difícil acceso. El avellanado a 90° produce chaflanes para tornillos estándar y limpia las rebabas de los agujeros taladrados. Adecuado para achaflanar agujeros en muchos materiales.

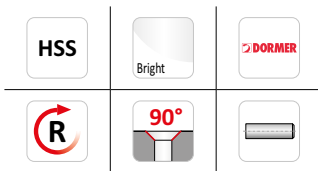

Grupo de Material de la pieza adecuado y condiciones de velocidad de corte iniciales (m/min) y código de avance alfabético. Tablas con avance por revolución a partir de la pag.251.

P1.1 ■ 20 E	P1.2 ■ 22 E	P1.3 ■ 23 E	P2.1 ■ 17 E	P2.2 ■ 15 D	P2.3 ■ 13 B	P3.1 ■ 12 D	P3.2 ■ 9 D	P3.3 ■ 8 B	P4.1 ■ 7 D	P4.2 ■ 6 B	M1.1 ■ 8 C	M1.2 ■ 6 C	M2.1 ■ 7 C
M2.2 ■ 16 C	K1.1 ■ 17 E	K1.2 ■ 12 C	K2.1 ■ 18 B	K2.2 ■ 14 B	K3.1 ■ 15 B	K3.2 ■ 11 B	K5.1 ■ 16 B	K5.2 ■ 12 B	N1.1 ■ 35 G	N1.2 ■ 25 G	N1.3 ■ 15 F	N2.1 ■ 15 F	N2.2 ■ 13 F
N3.1 ■ 16 E	N3.2 ■ 10 E	N3.3 ■ 5 C											

DCON MS tolerancia h9.

Producto	DC_2 (mm)	DC_1 (mm)	LCF (mm)	OAL (mm)	DCON MS (mm)	NOF
G6006.3	6.30	1.30	5.6	154.0	5.00	3
G6008.3	8.30	1.80	6.9	155.0	6.00	3
G60010.4	10.40	2.20	7.8	157.0	6.00	3
G60012.4	12.40	2.50	8.6	158.0	8.00	3
G60015.0	15.00	2.80	10.3	159.0	10.00	3
G60016.5	16.50	2.80	11.1	161.0	10.00	3
G60020.5	20.50	3.00	12.9	164.0	10.00	3
G60025.0	25.00	3.20	15.7	168.0	10.00	3



G132



Avellanador HSS a 90°, Multi Canales, Acabado Brillante

Avellanador de 90° diseñado para achaflanar agujeros para tornillos estándar y para eliminar rebabas en agujeros taladrados. Múltiples dientes para reducir vibraciones, lo que proporciona una operación de achaflanado suave. Herramienta versátil para su uso en aplicaciones manuales y en máquinas. Adecuado para achaflanar agujeros en la mayoría de materiales.

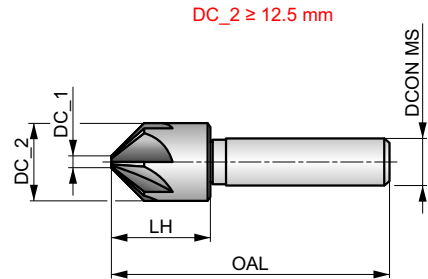
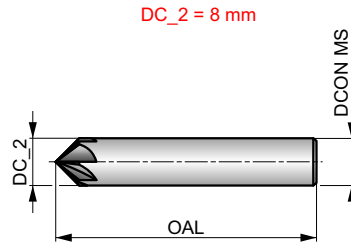

HSS	Bright	DIN 335A
R	90°	

Grupo de Material de la pieza adecuado y condiciones de velocidad de corte iniciales (m/min) y código de avance alfabético. Tablas con avance por revolución a partir de la pag.251.

P2.2 ▣ 18 E	P2.3 ▣ 16 D	P3.2 ▣ 13 D	P3.3 ▣ 11 B	P4.1 ▣ 10 D	P4.2 ▣ 8 C	P4.3 ▣ 7 B	M3.3 ▣ 3 A	M4.1 ▣ 4 A	K1.1 ▣ 20 F	K1.2 ▣ 15 D	K1.3 ▣ 11 D	K2.2 ▣ 17 C	K2.3 ▣ 14 D
K3.1 ▣ 18 E	K3.2 ▣ 14 E	K3.3 ▣ 11 D	K4.1 ▣ 17 C	K4.2 ▣ 13 C	K5.1 ▣ 19	K5.2 ▣ 15	K5.3 ▣ 11 D	N1.3 ▣ 20 F	N2.3 ▣ 13 F	N3.2 ▣ 12 F	N4.3 ▣ 5 G		

DCON MS tolerancia h9.

Producto	DC_2 (mm)	DC_1 (mm)	LH (mm)	OAL (mm)	DCON MS (mm)	NOF
G1328.0	8.00	—	—	48.0	8.00	5
G13212.5	12.50	2.00	15.5	48.0	8.00	5
G13216.0	16.00	3.20	19.5	56.0	10.00	7
G13220.0	20.00	5.00	23.0	60.0	10.00	7



G138



Avellanador HSS a 90°, Mango Cónico, con Acabado Brillante

Avellanador de 90° diseñado para achaflanar agujeros para tornillos estándar y para eliminar rebabas en agujeros taladrados. El mango cónico permite que la herramienta se pueda utilizar en aplicaciones de máquinas en las que se sujeta directamente en el husillo. Adecuado para achaflanar agujeros en la mayoría de materiales.

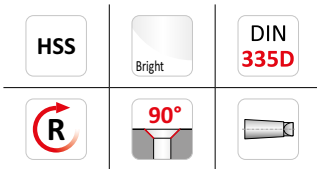
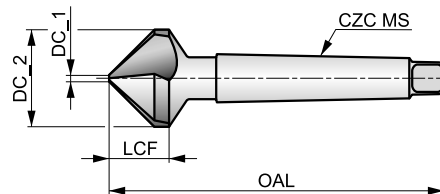

Grupo de Material de la pieza adecuado y condiciones de velocidad de corte iniciales (m/min) y código de avance alfabético. Tablas con avance por revolución a partir de la pag.251.

P1.1 ■ 23 E	P1.2 ■ 26 E	P1.3 ■ 27 E	P2.1 ■ 20 E	P2.2 ■ 18 D	P2.3 ▧ 16 B	P3.1 ■ 16 D	P3.2 ▧ 13 D	P3.3 ▧ 11 B	P4.1 ■ 10 D	P4.2 ▧ 8 B	M1.1 ▧ 8	M1.2 ▧ 6	M2.1 ▧ 7
M2.2 ▧ 6	K1.1 ▧ 20 F	K1.2 ▧ 15 D	K2.1 ▧ 21 C	K2.2 ▧ 17 C	K3.1 ▧ 18 C	K3.2 ▧ 14 C	K5.1 ▧ 19 C	K5.2 ▧ 15 C	N1.1 ▧ 40 G	N1.2 ■ 30 G	N1.3 ▧ 20 F	N2.1 ■ 20 F	N2.2 ▧ 18 F
N3.1 ■ 21 F	N3.2 ■ 12 F	N3.3 ▧ 6 D	N4.1 ▧ 40 G	N4.2 ▧ 35 G									

Producto	DC_2 (mm)	DC_1 (mm)	LCF (mm)	OAL (mm)	CZC MS	NOF
G13825.0	25.00	3.80	15.5	106.0	MK 2	3
G13830.0	30.00	4.20	18.5	112.0	MK 2	3
G13831.0	31.00	4.20	20.0	112.0	MK 2	3
G13834.0	34.00	4.50	19.5	118.0	MK 2	3
G13837.0	37.00	4.80	21.7	118.0	MK 2	3
G13840.0	40.00	10.00	20.5	140.0	MK 3	3
G13850.0	50.00	14.00	24.1	150.0	MK 3	3
G13863.0	63.00	16.00	28.5	180.0	MK 4	3
G13880.0	80.00	22.00	36.0	190.0	MK 4	3



G338



Avellanador HSS a 90°, Mango Cónico, con Recubrimiento TiN

Avellanador de 90° diseñado para achaflanar agujeros para tornillos estándar y para eliminar rebabas en agujeros taladrados. Rendimiento mejorado para mecanizar durante largos periodos a alta velocidad. El mango cónico permite sujetar la herramienta directamente en el husillo. El recubrimiento TiN mejora el rendimiento y prolonga la vida útil de la herramienta. Adecuado para la mayoría de materiales.

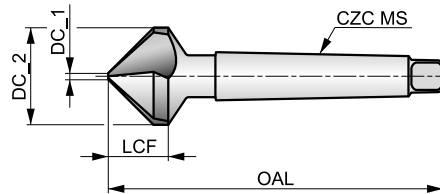

HSS	TiN	DIN 335D
R	90°	

Grupo de Material de la pieza adecuado y condiciones de velocidad de corte iniciales (m/min) y código de avance alfabético. Tablas con avance por revolución a partir de la pag.251.

P1.1 ■ 33 E	P1.2 ■ 37 E	P1.3 ■ 38 E	P2.1 ■ 28 E	P2.2 ■ 25 D	P2.3 ■ 22 B	P3.1 ■ 23 D	P3.2 ■ 18 D	P3.3 ■ 15 B	P4.1 ■ 13 D	P4.2 ■ 11 B	P4.3 ▧ 9 B	M1.1 ▧ 11 C	M1.2 ▧ 9 C
M2.1 ▧ 10 C	M2.2 ▧ 9 C	M2.3 ▧ 8 B	K1.1 ■ 34 F	K1.2 ■ 25 D	K1.3 ▧ 19 D	K2.1 ■ 35 C	K2.2 ■ 28 C	K2.3 ▧ 23 C	K3.1 ■ 31 C	K3.2 ■ 24 C	K3.3 ▧ 19 C	K4.1 ▧ 29 C	K4.2 ▧ 22 C
K4.3 ▧ 16 C	K5.1 ■ 32 C	K5.2 ■ 24 C	K5.3 ▧ 19 C	N1.1 ■ 53 G	N1.2 ■ 40 G	N1.3 ■ 27 F	N2.1 ■ 27 F	N2.2 ■ 24 F	N2.3 ■ 17 F	N3.1 ■ 28 F	N3.2 ■ 16 F	N3.3 ▧ 8 D	N4.1 ▧ 58 G
N4.2 ▧ 50 G													

Producto	DC_2 (mm)	DC_1 (mm)	LCF (mm)	OAL (mm)	CZC MS	NOF
G33825.0	25.00	3.80	15.5	106.0	MK 2	3
G33831.0	31.00	4.20	20.0	112.0	MK 2	3
G33837.0	37.00	4.80	21.7	118.0	MK 2	3
G33840.0	40.00	10.00	20.5	140.0	MK 3	3
G33850.0	50.00	14.00	24.1	150.0	MK 3	3
G33863.0	63.00	16.00	28.5	180.0	MK 4	3



G171



Avellanador HSS a 100°, Mango Cilíndrico, con Recubrimiento TiAlN

Un avellanador a 100° diseñado para achaflanar agujeros estándar y eliminar rebabas. Una herramienta versátil con recubrimiento TiAlN que mejora el rendimiento y aumenta la vida de filo. Se puede utilizar en máquinas automáticas y manuales. Adecuada para achaflanar agujeros en la mayoría de materiales.

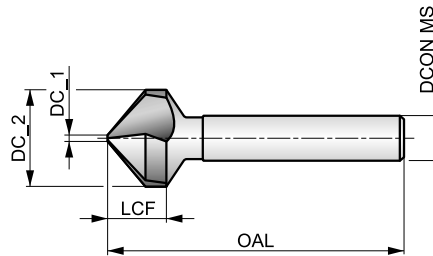

HSS	TiAlN	DIN 335C
R	100°	

Grupo de Material de la pieza adecuado y condiciones de velocidad de corte iniciales (m/min) y código de avance alfabético. Tablas con avance por revolución a partir de la pag.251.

P1.1 ■ 40 E	P1.2 ■ 45 E	P1.3 ■ 46 E	P2.1 ■ 34 E	P2.2 ■ 30 D	P2.3 ■ 27 B	P3.1 ■ 28 D	P3.2 ■ 22 D	P3.3 ■ 19 B	P4.1 ■ 16 D	P4.2 ■ 14 B	P4.3 ■ 11 B	M1.1 ■ 11 C	M1.2 ■ 9 C
M2.1 ■ 10 C	K1.1 ■ 41 F	K1.2 ■ 30 D	K1.3 ■ 23 D	K2.1 ■ 42 C	K2.2 ■ 34 C	K2.3 ■ 27 C	K3.1 ■ 37 C	K3.2 ■ 28 C	K3.3 ■ 23 C	K4.1 ■ 34 C	K4.2 ■ 26 C	K4.3 ■ 19 C	K5.1 ■ 39 C
K5.2 ■ 29 C	K5.3 ■ 23 C	N1.1 ■ 60 G	N1.2 ■ 45 G	N1.3 ■ 30 F	N2.1 ■ 30 F	N2.2 ■ 27 F	N2.3 ■ 19 F	N3.1 ■ 32 F	N3.2 ■ 18 F	N3.3 ■ 9 D	N4.1 ■ 62 G	N4.2 ■ 55 G	

DCON MS tolerancia h9.

Producto	DC_2 (mm)	DC_1 (mm)	LCF (mm)	OAL (mm)	DCON MS (mm)	NOF
G1716.3	6.30	1.50	4.5	44.0	5.00	3
G1718.3	8.30	2.00	5.5	49.0	6.00	3
G17110.4	10.40	2.50	6.6	49.0	6.00	3
G17112.4	12.40	2.80	7.0	53.0	8.00	3
G17116.5	16.50	3.20	9.0	56.0	10.00	3
G17120.5	20.50	3.50	11.0	61.0	10.00	3
G17125.0	25.00	3.80	13.5	65.0	10.00	3



G314



Broca HSS Multi-Diámetro, para Chapas Metálicas, Acabado Brillante

Las brocas escalonadas cónicas tienen un diseño de varios diámetros que permite la ampliación gradual de los agujeros hasta el diámetro requerido. El mango cilíndrico reducido hace que todos los diámetros se puedan sujetar en un portabrocas y un soporte estándar. Adecuado para agrandar agujeros en muchos materiales.

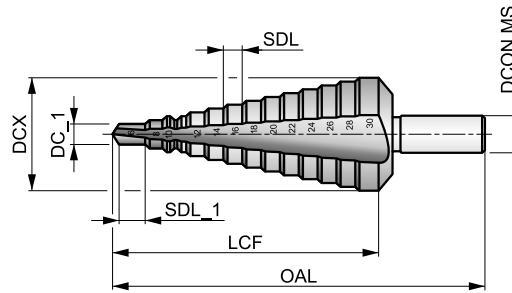

HSS	Bright	DORMER
R	20°	

Grupo de Material de la pieza adecuado y condiciones de velocidad de corte iniciales (m/min) y código de avance alfabético. Tablas con avance por revolución a partir de la pag.251.

P1.1 ■ 20	P1.2 ■ 22	P1.3 ■ 23	P2.1 ■ 17	P2.2 ■ 15	P2.3 ■ 13	P3.1 ■ 12	P3.2 ■ 9	M1.1 ■ 8	M1.2 ■ 6	M2.1 ■ 7	K1.1 ■ 17	N1.1 ■ 30	N1.2 ■ 23
N1.3 ■ 15	N2.1 ■ 31	N2.2 ■ 28	N3.1 ■ 34	N3.2 ■ 20	N3.3 ■ 10	N4.1 ■ 30	N4.2 ■ 20						

SDI = Incrementos de diámetro de paso.

Producto	Nr.	DC_1	DCX	SDL	SDI	SDL_1	LCF	OAL	DCON MS
		(mm)	(mm)	(mm)	(mm)	(mm)	(mm)	(mm)	(mm)
G314412	412	4.00	12.00	5.00	4 - 5 - 6 - 7 - 8 - 9 - 10 - 11 - 12	5.00	61.0	80.0	6.00
G3141220	1220	12.00	20.00	4.00	12 - 13 - 14 - 15 - 16 - 17 - 18 - 19 - 20	4.00	55.0	76.0	9.00
G3142030	2030	20.00	30.00	4.00	20 - 21 - 22 - 23 - 24 - 25 - 26 - 27 - 28 - 29 - 30	4.00	67.0	88.0	12.00
G3143040	3040	30.00	40.00	4.00	30 - 31 - 32 - 33 - 34 - 35 - 36 - 37 - 38 - 39 - 40	4.00	74.0	98.0	13.00
G314420	420	4.00	20.00	4.00	4 - 6 - 8 - 10 - 12 - 14 - 16 - 18 - 20	4.00	48.0	76.0	8.00
G314630	630	6.00	30.00	4.00	6 - 8 - 10 - 12 - 14 - 16 - 18 - 20 - 22 - 24 - 26 - 28 - 30	4.00	73.0	98.0	10.00
G314M	M	9.00	36.00	3.00	9 - 12 - 15 - 18 - 21 - 24 - 27 - 30 - 33 - 36	3.00	57.0	86.0	12.00



G125



Refrentador HSS a 180°, Mango Cilíndrico, Acabado Brillante

Avellanador con un ángulo de 180° diseñado para producir agujeros para tornillos de cabeza estándar. Tiene un piloto sólido (disponible para diferentes tolerancias de agujero premecanizado), que ayuda a guiar con precisión el avellanado en agujeros de tamaño métrico estándar. Adecuado para avellanar agujeros en muchos materiales.

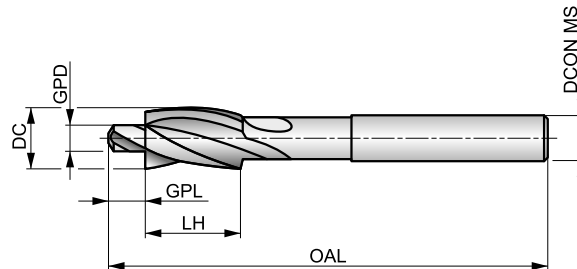

HSS	Bright	DIN 373
R	180°	

Grupo de Material de la pieza adecuado y condiciones de velocidad de corte iniciales (m/min) y código de avance alfabético. Tablas con avance por revolución a partir de la pag.251.

P1.1 ■ 20 E	P1.2 ■ 22 E	P1.3 ■ 23 E	P2.1 ■ 17 E	P2.2 ■ 15 D	P2.3 ■ 13 C	P3.1 ■ 12 D	P3.2 ■ 9 D	P3.3 ■ 8 C	P4.1 ■ 7 D	P4.2 ■ 6 C	M1.1 ■ 8 D	M1.2 ■ 6 D	M2.1 ■ 7 D
M2.2 ■ 6 D	M2.3 ■ 5 C	K1.1 ■ 17 E	K1.2 ■ 12 E	K1.3 ■ 11 E	K2.1 ■ 15 D	K2.2 ■ 12 D	K2.3 ■ 10 C	K3.1 ■ 13 D	K3.2 ■ 10 D	K4.1 ■ 12 D	K4.2 ■ 9 D	K5.1 ■ 14 D	K5.2 ■ 10 D
N1.1 ■ 30 G	N1.2 ■ 23 G	N1.3 ■ 15 G	N2.1 ■ 31 G	N2.2 ■ 28 G	N2.3 ■ 20 G	N3.1 ■ 34 C	N3.2 ■ 20 C	N3.3 ■ 10 C	N4.1 ■ 30 C	N4.2 ■ 20 C			

DCON MS tolerancia h9.

Producto	DC (mm)	GPD (mm)	CZC MS	GPL (mm)	OAL (mm)	LH (mm)	DCON MS (mm)	NOF
G1256.5X2.5 ³⁾	6.50	2.50	M 3 t	4.50	71.0	14.0	5.00	3
G1256.5X3.2 ¹⁾	6.50	3.20	M 3 f	4.50	71.0	14.0	5.00	3
G1256.5X3.4 ²⁾	6.50	3.40	M 3 m	4.50	71.0	14.0	5.00	3
G1258.0X3.3 ³⁾	8.00	3.30	M 4 t	5.00	71.0	14.0	5.00	3
G1258.0X4.3 ¹⁾	8.00	4.30	M 4 f	5.00	71.0	14.0	5.00	3
G1258.0X4.5 ²⁾	8.00	4.50	M 4 m	5.00	71.0	14.0	5.00	3
G12510.0X4.2 ³⁾	10.00	4.20	M 5 t	5.50	80.0	18.0	8.00	3
G12510.0X5.3 ¹⁾	10.00	5.30	M 5 f	5.50	80.0	18.0	8.00	3
G12510.0X5.5 ²⁾	10.00	5.50	M 5 m	5.50	80.0	18.0	8.00	3
G12511.0X5.0 ³⁾	11.00	5.00	M 6 t	6.00	80.0	18.0	8.00	3
G12511.0X6.4 ¹⁾	11.00	6.40	M 6 f	6.00	80.0	18.0	8.00	3
G12511.0X6.6 ²⁾	11.00	6.60	M 6 m	6.00	80.0	18.0	8.00	3
G12515.0X6.8 ³⁾	15.00	6.80	M 8 t	8.00	100.0	22.0	12.50	3
G12515.0X8.4 ¹⁾	15.00	8.40	M 8 f	8.00	100.0	22.0	12.50	3
G12515.0X9.0 ²⁾	15.00	9.00	M 8 m	8.00	100.0	22.0	12.50	3
G12518.0X8.5 ³⁾	18.00	8.50	M 10 t	10.00	100.0	22.0	12.50	3
G12518.0X10.5 ¹⁾	18.00	10.50	M 10 f	10.00	100.0	22.0	12.50	3
G12518.0X11.0 ²⁾	18.00	11.00	M 10 m	10.00	100.0	22.0	12.50	3
G12520.0X10.2 ³⁾	20.00	10.20	M 12 t	10.00	100.0	22.0	12.50	3
G12520.0X13.0 ¹⁾	20.00	13.00	M 12 f	10.00	100.0	22.0	12.50	3
G12520.0X13.5 ²⁾	20.00	13.50	M 12 m	10.00	100.0	22.0	12.50	3

¹⁾ f= Para agujero pasante fino

²⁾ m= Para agujero pasante medio

³⁾ t= para agujero roscado



G236



Juego de Avellanadores en Caja de Plástico Cilíndrica

Juegos que contienen varios tamaños de avellanadores a 90°. Hay 5 juegos diferentes con G106, G136 o G560 disponibles. Adecuados para muchos materiales.

A=Tipos en el Juego, B=No en el Juego, C=Diámetros en el Juego.

Producto	Nr.	A	B	C
G2361	1	G136	6	6.30 mm, 8.30 mm, 10.40 mm, 12.40 mm, 16.50 mm, 20.50 mm
G2362	2	G136	4	6.30 mm, 10.40 mm, 16.50 mm, 20.50 mm
G2363	3	G560	6	6.30 mm, 8.30 mm, 10.40 mm, 12.40 mm, 16.50 mm, 20.50 mm
G2364	4	G106	6	6.30 mm, 8.30 mm, 10.40 mm, 12.40 mm, 16.50 mm, 20.50 mm
G2365	5	G506	6	6.30 mm, 8.30 mm, 10.40 mm, 12.40 mm, 16.50 mm, 20.50 mm



TABLA DE VELOCIDADES DE AVANCE PARA ESCARIADORES

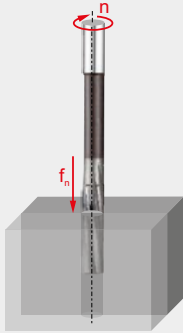

Avance por revolución (f_n en mm/rev)
Dependiendo de las condiciones de trabajo puede ser necesario ajustar estos valores $\pm 15\%$

Cómo utilizar esta tabla para encontrar el valor de avance por revolución (f_n):

1. Localice su código alfa en la página del producto (ejemplo: 21C, «C» es el código alfa).
2. Localice en la fila superior de la tabla el diámetro más adecuado para su aplicación de corte.
3. Localice su código alfa en la columna de la izquierda de la tabla.
4. La intersección (celda) del diámetro y el código alfa es el avance por revolución (f_n).

		ø DC (mm)																		
		1.00	1.50	2.00	3.00	4.00	5.00	6.00	7.00	8.00	10.00	12.00	15.00	16.00	20.00	25.00	30.00	40.00	50.00	80.00
Avances	A	0.030	0.045	0.055	0.078	0.090	0.100	0.125	0.137	0.150	0.170	0.185	0.210	0.220	0.250	0.280	0.320	0.390	0.440	0.500
	B	0.035	0.055	0.072	0.110	0.130	0.150	0.165	0.172	0.180	0.210	0.240	0.270	0.280	0.310	0.360	0.400	0.500	0.550	0.600
	C	0.040	0.065	0.085	0.135	0.160	0.185	0.200	0.210	0.220	0.260	0.285	0.325	0.335	0.390	0.440	0.480	0.600	0.680	0.750
	D	0.050	0.080	0.110	0.160	0.180	0.200	0.235	0.253	0.270	0.320	0.360	0.400	0.410	0.470	0.540	0.600	0.730	0.850	0.950
	E	0.065	0.100	0.140	0.180	0.215	0.250	0.300	0.325	0.350	0.390	0.430	0.485	0.500	0.530	0.640	0.750	0.910	1.100	1.200
	F	0.090	0.140	0.180	0.260	0.305	0.350	0.395	0.417	0.440	0.500	0.550	0.610	0.630	0.700	0.800	0.930	1.200	1.500	1.650

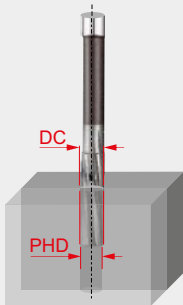

Sobreespesor de mecanizado al utilizar un **escariador de máquina** (MA en mm)
Diámetro de agujero premecanizado
 $PHD = DC - MA$

Cómo utilizar esta tabla para encontrar el diámetro correcto del agujero premecanizado (PHD):

1. Localice en la fila superior de la tabla el rango de diámetro más adecuado para su aplicación de corte.
2. Localice su código de grupo ISO en la columna de la izquierda de la tabla (ejemplo: para el acero inoxidable, el código de grupo ISO es «M»)
3. La intersección (celda) del rango de diámetro y el código de grupo ISO es el sobreespesor de mecanizado (MA)
4. Reste el sobreespesor de mecanizado al diámetro de escariado para obtener el diámetro de agujero premecanizado (PHD).

(Ejemplo: para un agujero de 6 mm en acero (P), el PHD es de 5,85 mm)

		ø DC (mm)										
		1.00	5.00	5.00	8.00	8.00	12.00	12.00	16.00	16.00	30.00	30.00
Grupo ISO	P	0.10		0.15		0.20		0.20		0.30		0.30
	M	0.08		0.10		0.10		0.20		0.20		0.30
	K	0.10		0.15		0.20		0.20		0.30		0.30
	N	0.10		0.15		0.20		0.20		0.30		0.30
	S	0.05		0.10		0.10		0.15		0.20		0.20
	H	0.05		0.05		0.10		0.10		0.15		0.20

Tenga cuidado con las tolerancias de mecanizado de las brocas, ya que el diámetro de la herramienta no es el mismo que el diámetro del agujero producido.

Nota: El sobreespesor recomendado al utilizar un escariador manual es de 0,05 a 0,10 mm



TABLA DE VELOCIDADES DE AVANCE PARA AVELLANADORES

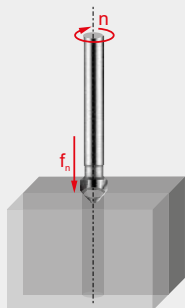

Avance por revolución (f_n en mm/rev)
Dependiendo de las condiciones de trabajo puede ser necesario ajustar estos valores $\pm 15\%$

Cómo utilizar esta tabla para encontrar el valor de avance por revolución (f_n):

1. Localice su código alfa en la página del producto (ejemplo: 23E, «E» es el código alfa).
2. Localice en la fila superior de la tabla el diámetro más adecuado para su aplicación de corte.
3. Localice su código alfa en la columna de la izquierda de la tabla.
4. La intersección (celda) del diámetro y el código alfa es el avance por revolución (f_n).

	$\varnothing DC$ (mm)										
	6.00	8.00	10.00	16.00	20.00	25.00	32.00	40.00	60.00	80.00	
Avances	A	0.030	0.040	0.050	0.060	0.080	0.090	0.100	0.120	0.140	0.160
	B	0.040	0.050	0.060	0.080	0.100	0.120	0.140	0.160	0.180	0.200
	C	0.050	0.060	0.080	0.100	0.120	0.140	0.160	0.180	0.200	0.220
	D	0.060	0.080	0.100	0.120	0.150	0.180	0.200	0.220	0.250	0.280
	E	0.080	0.100	0.120	0.150	0.180	0.200	0.250	0.270	0.300	0.320
	F	0.090	0.110	0.130	0.160	0.190	0.210	0.260	0.290	0.330	0.360
	G	0.100	0.120	0.150	0.180	0.200	0.220	0.280	0.320	0.360	0.400
	H	0.120	0.150	0.180	0.200	0.220	0.250	0.300	0.350	0.400	0.450

Definiciones y nomenclatura del escariador

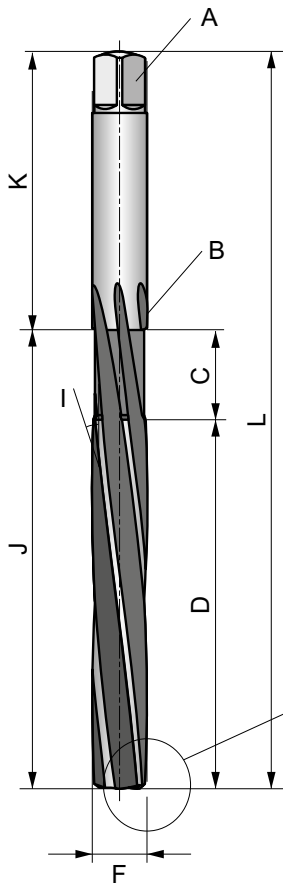

A	Espiga o cuadradillo de arrastre
B	Diámetro de sangrado
C	Longitud de sangrado
D	Longitud de corte
E	Longitud del paso biselado
F	Diámetro

G	Paso biselado
H	Ángulo del chaflán de entrada
I	Ángulo de helice
J	Longitud del cuerpo
K	Longitud del mango
L	Longitud total

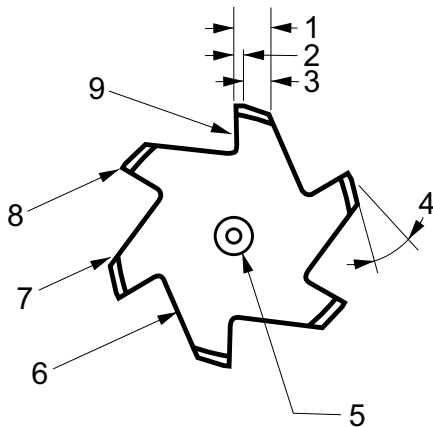
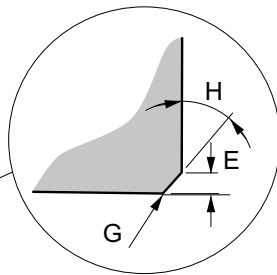

1	Ancho de la parte plana
2	Cara plana circular
3	Espacio libre
4	Ángulo de desprendimiento
5	Agujero central
6	Canal
7	Talón
8	Filo de corte
9	Cara

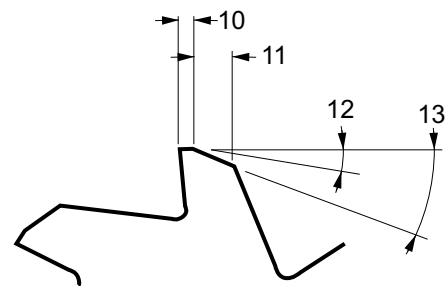

10	Ancho de holgura primaria
11	Ancho de holgura secundaria
12	Ángulo de salida primario
13	Ángulo de salida secundario



ESCARIADO: INFORMACIÓN TÉCNICA

Escariado

Para obtener los mejores resultados con los escariadores, es esencial hacerlos 'trabajar'. Un error frecuente es el de preparar orificios para escariar dejando dentro poco material. Si se deja en el orificio material insuficiente antes de escariar, el escariador rozará, se desgastará rápidamente y el resultado será la pérdida de diámetro. Para garantizar un buen rendimiento, también es importante no dejar demasiado material en el agujero. (Véase el apartado "Eliminación de material" a continuación).

1. Seleccionar el tipo óptimo de escariador y las velocidades y avances óptimos para la aplicación. Asegurar que los agujeros pretaladrados sean del diámetro correcto.
2. La pieza de trabajo debe sujetarse rígida y el husillo de la máquina no debe tener juego.
3. El portapinzas en el que se sujeta un escariador de mango recto debe ser de buena calidad. Si el escariador resbala en el portapinzas y el avance es automático, el escariador podría romperse.
4. Mantener al mínimo el voladizo de la herramienta respecto al husillo de la máquina.

5. Usar los lubricantes recomendados para prolongar la vida útil del escariador y asegurar que el fluido llegue a los filos de corte. Como la operación de escariar no es un trabajo de corte pesado, normalmente bastará una disolución 40:1 de aceite soluble. Cuando se trata de mecanizado en seco, se puede emplear aire a presión (ej. con el mecanizado de acero de fundición gris).
6. No permitir que las estrías del escariador se atasquen de virutas.
7. Antes de volver a reafilar el escariador, comprobar la concentricidad entre centros. En la mayoría de los casos, sólo habrá que rectificar el paso del bisel.
8. Mantener afilados los escariadores. El reafilado frecuente es rentable, pero es importante entender que los escariadores sólo cortan en el chaflán de entrada y no en las superficies entre estrías. Por lo tanto, sólo hay que rectificar dichas superficies. La exactitud de la rectificación es importante para la calidad del acabado del orificio y la vida útil de la herramienta.

Eliminación de material

La eliminación de material recomendada al escariar depende del material de aplicación y el acabado de la superficie del orificio pretaladrado. En la siguiente tabla se dan las directrices generales para la eliminación de material:

Tamaño del agujero escariado (mm)	Con pretaladrado	Con pretaladrado de núcleo
Menos de 4	0.1	0.1
De 4 a 11	0.2	0.15
De 11 a 39	0.3	0.2
De 39 a 50	0.4	0.3

Tamaño del agujero escariado (pulgadas)	Con pretaladrado	Con pretaladrado de núcleo
Menos de 3/16"	0.004"	0.004"
3/16" a 1/2"	0.008"	0.006"
1/2" a 1 1/2"	0.010"	0.008"
1 1/2" a 2"	0.016"	0.010"

ESCARIADO MANUAL/A MÁQUINA

Aunque tanto los escariadores manuales como los de máquina ofrecen la misma capacidad en cuanto al tamaño del agujero terminado, el uso de uno u otro debe considerarse según la aplicación. Por razones de alineación, un escariador manual tiene una entrada cónica larga, mientras que un escariador de máquina cuenta con un paso biselado de tan solo 45°. Un escariador de máquina solo corta en el paso biselado, mientras que un escariador manual corta tanto en el paso biselado como en el cónico.



ESCARIADO: LÍMITES DE TOLERANCIA E INFORMACIÓN TÉCNICA

Límites de tolerancia

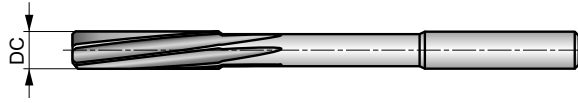

1. En el diámetro de corte de los escariadores estándar

El diámetro (DC) se mide sobre la superficie circular entre estrías inmediatamente detrás del bisel o paso cónico. La tolerancia se ajusta a DIN 1420 y sirve para producir agujeros H7.

TOLERANCIA DEL ESCARIADOR			
Diámetro (mm)		Límite de tolerancia (mm)	
Por encima de	Hasta e incluido	Alto +	Bajo +
–	3	0.008	0.004
3	6	0.010	0.005
6	10	0.012	0.006
10	18	0.015	0.008

TOLERANCIA DEL ESCARIADOR			
Diámetro (mm)		Límite de tolerancia (mm)	
Por encima de	Hasta e incluido	Alto +	Bajo +
18	30	0.017	0.009
30	50	0.021	0.012
50	80	0.025	0.014

2. En un agujero H7

La tolerancia más común en un agujero acabado es H7 (ver la tabla de abajo). Para cualquier otra tolerancia, ver la figura y la tabla del punto 3 (se muestra más abajo); esta tabla se puede usar para calcular el ancho y la ubicación de tolerancia de los escariadores.

TOLERANCIA DEL AGUJERO			
Diámetro (mm)		Límite de tolerancia (mm)	
Por encima de	Hasta e incluido	Alto +	Bajo +
–	3	0.010	0
3	6	0.012	0
6	10	0.015	0
10	18	0.018	0

TOLERANCIA DEL AGUJERO			
Diámetro (mm)		Límite de tolerancia (mm)	
Por encima de	Hasta e incluido	Alto +	Bajo +
18	30	0.021	0
30	50	0.025	0
50	80	0.030	0

3. Cuando es necesario definir las dimensiones para un escariador especial para cortar según una tolerancia específica, por ejemplo D8, se puede usar esta guía.

Ancho de tolerancia del diámetro (μm)								
Ancho de tolerancia (micrones)	por encima de 1 incl. 3	por encima de 3 incl. 6	por encima de 6 incl. 10	por encima de 10 incl. 18	por encima de 18 incl. 30	por encima de 30 incl. 50	por encima de 50 incl. 80	por encima de 80 incl. 120
IT5	4	5	6	8	9	11	13	15
IT6	6	8	9	11	13	16	19	22
IT7	10	12	15	18	21	25	30	35
IT8	14	18	22	27	33	39	46	54
IT9	25	30	36	43	52	62	74	87
IT10	40	48	58	70	84	100	120	140
IT11	60	75	90	110	130	160	190	220
IT12	100	120	150	180	210	250	300	350

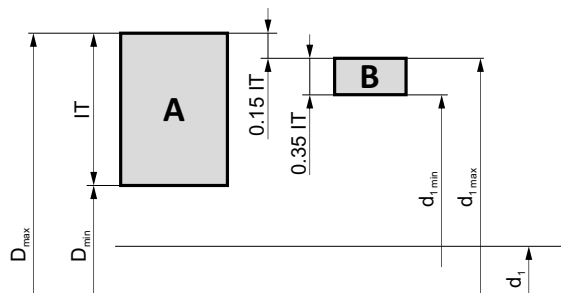

- A** = Tolerancia del Agujero
- B** = Tolerancia del Escariador
- IT** = Ancho de tolerancia
- D_{max} = Diámetro máx. del agujero
- D_{min} = Diámetro mín. del agujero
- d_1 = Diámetro nominal
- d_{1max} = Diámetro máx. del escariador
- d_{1min} = Diámetro mín. del escariador

por ejemplo: agujero de 10 mm con tolerancia D8, diám. máx. = 10,062, diám. mín. = 10,040, toler. del agujero (IT8) = 0,022

Límite máximo: 0.15 x tolerancia de agujero (IT8) = 0.0033, redondeado = 0.004

Límite mínimo: 0.35 x tolerancia de agujero (IT8) = 0.0077, redondeado = 0.008

Límite máximo para escariador = 10.062 - 0.004 = 10.058

Límite mínimo para escariador = 10.058 - 0.008 = 10.050



ESCARIADO: INFORMACIÓN TÉCNICA

Selección de escariadores en función de la aplicación

Los tipos más comunes de escariadores tienen una espiral a la izquierda, ya que las principales aplicaciones incluyen agujeros pasantes que requieren que las virutas sean impulsadas hacia adelante. Para los agujeros ciegos se recomienda el uso de escariadores con canales rectos o espirales a la derecha.

Las condiciones de escariado más eficaces dependen de la aplicación, el material, la calidad del agujero requerido, el arranque de viruta, la lubricación y otros factores. En las tablas de WMG y de avance de los escariadores de máquina (véase el catálogo de Dormer o el selector

de productos) y en las tablas de arranque de viruta se muestra una guía general de las velocidades superficiales y los avances de los escariadores.

El espacio extremadamente desigual en los escariadores significa que la división no es la misma para cada diente. Como no hay dos dientes diametralmente opuestos, el escariador produce un agujero con una variación de redondez de entre 1 y 2 μm . La diferencia es de hasta 10 μm con el espaciado desigual convencional.

Escariadores de metal duro: comparación de espaciado/espaciado europeo

Espaciado desigual
Error de redondez de hasta 10 μm

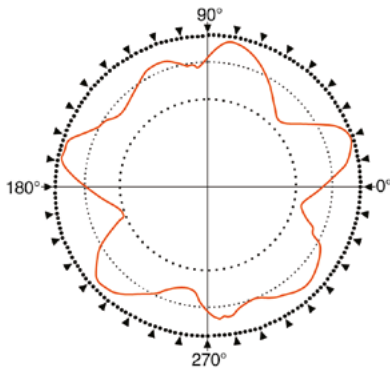

Resultados de redondez

Espaciado extremadamente desigual
Error de redondez de hasta 1-2 μm

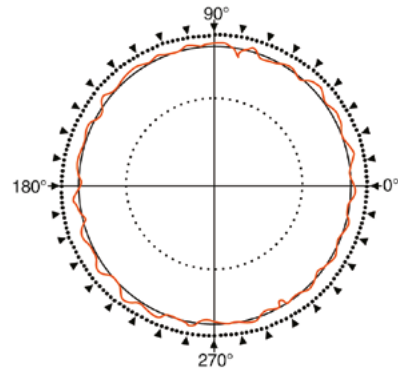

Resultados de redondez



ESCARIADO: INDICACIONES GENERALES E INFORMACIÓN TÉCNICA

Problemas en el escariado

Problema	Causa	Remedio
Rotura o torsión en la espiga	Ajuste incorrecto entre el mango y el portaherramientas	Comprobar que el mango y el portaherramientas están limpios y no están dañados
Desgaste rápido de la herramienta	Material insuficiente que eliminar	Aumentar la cantidad de material que eliminar
Agujero sobredimensionado	Excesiva variación de la altura del labio	Reafilarse según las especificaciones correctas
	Desplazamiento en el husillo de la máquina	Reparar y rectificar el desplazamiento del husillo
	Desviaciones en el portaherramientas	Reemplazar el portaherramientas
	El mango de la herramienta está dañado	Sustituir o rectificar el mango
	Forma ovalada de la herramienta	Sustituir o rectificar la herramienta
	Ángulo del paso biselado asimétrico	Reafilarse según las especificaciones correctas
	Avance o velocidad de corte de la herramienta demasiado alto	Ajustar las condiciones de corte de acuerdo con el catálogo
Menor tamaño del agujero	Material insuficiente que eliminar	Aumentar la cantidad de material que eliminar
	Excesiva generación de calor en el escariado El agujero se amplía y se contrae	Incrementar la refrigeración
	El diámetro de la herramienta está desgastado e infradimensionado	Reafilarse según las especificaciones correctas
	Avance o velocidad de corte de la herramienta demasiado baja	Ajustar las condiciones de corte de acuerdo con el catálogo
	El agujero pretaladrado es demasiado pequeño	Reducir la cantidad de material que eliminar
Agujeros ovalados y cónicos	Desplazamiento en el husillo de la máquina	Reparar y rectificar el desplazamiento del husillo
	Mal centrado entre la herramienta y el agujero	Usar un escariador guiado
	Ángulo de avance del bisel asimétrico	Reafilarse según las especificaciones correctas
Acabado del agujero deficiente	Excesivo material a eliminar	Reducir la cantidad de material que eliminar
	Herramienta muy gastada	Reafilarse según las especificaciones correctas
	Ángulo de desprendimiento demasiado pequeño	Reafilarse según las especificaciones correctas
	Emulsión o aceite de corte demasiado diluido	Incrementar el % de concentración
	Avance y/o velocidad demasiado baja	Ajustar las condiciones de corte de acuerdo con el catálogo
	Velocidad de corte demasiado alta	Ajustar las condiciones de corte de acuerdo con el catálogo
La herramienta se clava o se rompe	Herramienta muy gastada	Reafilarse según las especificaciones correctas
	Chaflán de salida de la herramienta demasiado pequeño	Verificar y reemplazar o modificar la herramienta
	Ancho entre estrías demasiado grande	Verificar y reemplazar o modificar la herramienta
	El material de la pieza de trabajo tiende a retorcerse	Utilizar un escariador regulable para compensar el desplazamiento
	El agujero pretaladrado es demasiado pequeño	Reducir la cantidad de material que eliminar
	Material heterogéneo con inclusiones duras	Usar un escariador de metal duro



INFORMACIÓN TÉCNICA GENERAL

	Calidad	Dureza (HV10)	C %	W %	Mo %	Cr %	V %	Co %	Material de la herramienta
	M2	810 – 850	0.9	6.4	5.0	4.2	1.8	–	HSS
	M35	830 – 870	0.93	6.4	5.0	4.2	1.8	4.8	HSCO
	M42	870 – 960	1.08	1.5	9.4	3.9	1.2	8.0	

Propiedades	Materiales HSS	Materiales de metal duro	K10/30F (se suele utilizar para herramientas duras)
Dureza (HV30)	800-950	1300 – 1800	1600
Densidad (g/cm ³)	8.0 – 9.0	7.2 – 15	14.45
Fuerza de compresión (N/mm ²)	3000 – 4000	3000 – 8000	6250
Resistencia a la flexión, (flexión) (N/mm ²)	2500 – 4000	1000 – 4700	4300
Resistencia al calor (°C)	550	1000	900
Módulo eléctrico (KN/mm ²)	260 – 300	460 – 630	580
Tamaño de grano (µm)	–	0.2 – 10	0.8

La combinación de la partícula dura (WC) y el metal aglutinante (Co) provoca los siguientes cambios en las características.

Característica	Un mayor contenido de WC	Un mayor contenido de Co
Dureza	Mayor dureza	Menor dureza
Fuerza de compresión (CS)	Mayor CS	Menor CS
Resistencia a la flexión (BS)	Menor BS	Mayor BS

El tamaño de grano también influye en las propiedades del material. Los tamaños de grano pequeños se traducen en una mayor dureza y los granos gruesos, en una mayor tenacidad.

Tratamiento de la superficie y ejemplos de propiedades del recubrimiento

Tratamientos de la superficie	Color	Material de recubrimiento	Dureza (HV)	Espesor (µm)	Estructura del recubrimiento	Coefficiente de fricción respecto al acero	Temp. aplic. máx. (°C)
	Oro	TiN	2300	1-4	Monocapa	0.4	600
	Gris negruzco	TiAlN	3300	3	Nanoestructura	0.3-0.35	900



INFORMACIÓN TÉCNICA GENERAL

Tolerancias estándar de la industria para ejes y agujeros

Los valores de tolerancia se indican en micras (μm)

Fórmula para las micras ...1 $\mu\text{m} = 0,001 \text{ mm} / 0,000039''$

Tolerancia	Diámetro (mm)							
	> 1 ≤ 3	> 3 ≤ 6	> 6 ≤ 10	> 10 ≤ 18	> 18 ≤ 30	> 30 ≤ 50	> 50 ≤ 80	> 80 ≤ 120
	Diámetro (pulgadas)							
	> 0.039" ≤ 0.118"	> 0.118" ≤ 0.236"	> 0.236" ≤ 0.394"	> 0.394" ≤ 0.709"	> 0.709" ≤ 1.181"	> 1.181" ≤ 1.968"	> 1.968" ≤ 3.149"	> 3.149" ≤ 4.724"
Valores de tolerancia (μm)								
e8	-14 / -28	-20 / -38	-25 / -47	-32 / -59	-40 / -73	-50 / -89	-60 / -106	-72 / -126
f6	-6 / -12	-10 / -18	-13 / -22	-16 / -27	-20 / -33	-25 / -41	-30 / -49	-36 / -58
f7	-6 / -16	-10 / -22	-13 / -28	-16 / -34	-20 / -41	-25 / -50	-30 / -60	-36 / -71
h6	0 / -6	0 / -8	0 / -9	0 / -11	0 / -13	0 / -16	0 / -19	0 / -22
h7	0 / -10	0 / -12	0 / -15	0 / -18	0 / -21	0 / -25	0 / -30	0 / -35
h8	0 / -14	0 / -18	0 / -22	0 / -27	0 / -33	0 / -39	0 / -46	0 / -54
h9	0 / -25	0 / -30	0 / -36	0 / -43	0 / -52	0 / -62	0 / -74	0 / -87
h10	0 / -40	0 / -48	0 / -58	0 / -70	0 / -84	0 / -100	0 / -120	0 / -140
h11	0 / -60	0 / -75	0 / -90	0 / -110	0 / -130	0 / -160	0 / -190	0 / -220
h12	0 / -100	0 / -120	0 / -150	0 / -180	0 / -210	0 / -250	0 / -300	0 / -350
k10	+ 40 / 0	+ 48 / 0	+ 58 / 0	+ 70 / 0	+ 84 / 0	+ 100 / 0	+ 120 / 0	+ 140 / 0
k12	+ 100 / 0	+ 120 / 0	+ 150 / 0	+ 180 / 0	+ 210 / 0	+ 250 / 0	+ 300 / 0	+ 350 / 0
m7	+ 2 / + 12	+ 4 / + 16	+ 6 / + 21	+ 7 / + 25	+ 8 / + 29	+ 9 / + 34	+ 11 / + 41	+ 13 / + 48
js14	+ / -125	+ / -150	+ / -180	+ / -215	+ / -260	+ / -310	+ / -370	+ / -435
js16	+ / -300	+ / -375	+ / -450	+ / -550	+ / -650	+ / -800	+ / -950	+ / -1100
H7	+ 10 / 0	+ 12 / 0	+ 15 / 0	+ 18 / 0	+ 21 / 0	+ 25 / 0	+ 30 / 0	+ 35 / 0
H8	+ 14 / 0	+ 18 / 0	+ 22 / 0	+ 27 / 0	+ 33 / 0	+ 39 / 0	+ 46 / 0	+ 54 / 0
H9	+ 25 / 0	+ 30 / 0	+ 36 / 0	+ 43 / 0	+ 52 / 0	+ 62 / 0	+ 74 / 0	+ 87 / 0
H12	+ 100 / 0	+ 120 / 0	+ 150 / 0	+ 180 / 0	+ 210 / 0	+ 250 / 0	+ 300 / 0	+ 350 / 0
P9	-6 / -31	-12 / -42	-15 / -51	-18 / -61	-22 / -74	-26 / -86	-32 / -106	-37 / -124
S7	-13 / -22	-15 / -27	-17 / -32	-21 / -39	-27 / -48	-34 / -59	-42 / -72	-58 / -93



INFORMACIÓN TÉCNICA GENERAL

Tabla de velocidades de corte

		Vc															
m/min		5	8	10	15	20	25	30	40	50	60	70	80	90	100	110	150
SFM (pies/min)		16	26	32	50	66	82	98	130	165	197	230	262	296	330	362	495
Ø		RPM															
mm	pulgadas																
1.00	—	1592	2546	3183	4775	6366	7958	9549	12732	15916	19099	22282	25465	28648	31831	35014	47747
1.50	—	1061	1698	2122	3183	4244	5305	6366	8488	10610	12732	14854	16977	19099	21221	23343	31831
2.00	—	796	1273	1592	2387	3183	3979	4775	6366	7958	9549	11141	12732	14324	15916	17507	23873
2.50	—	637	1019	1273	1910	2546	3183	3820	5093	6366	7639	8913	10186	11459	12732	14006	19099
3.00	—	531	849	1061	1592	2122	2653	3183	4244	5305	6366	7427	8488	9549	10610	11671	15916
3.18	1/8	500	801	1001	1501	2002	2502	3003	4004	5005	6006	7007	8008	9009	10010	11011	15015
3.50	—	455	728	909	1364	1819	2274	2728	3638	4547	5457	6366	7276	8185	9095	10004	13642
4.00	—	398	637	796	1194	1592	1989	2387	3183	3979	4775	5570	6366	7162	7958	8754	11937
4.50	—	354	566	707	1061	1415	1768	2122	2829	3537	4244	4951	5659	6366	7074	7781	10610
4.76	3/16	334	535	669	1003	1337	1672	2006	2675	3344	4012	4681	5350	6018	6687	7356	10031
5.00	—	318	509	637	955	1273	1592	1910	2546	3183	3820	4456	5093	5730	6366	7003	9549
6.00	—	265	424	531	796	1061	1326	1592	2122	2653	3183	3714	4244	4775	5305	5836	7958
6.35	1/4	251	401	501	752	1003	1253	1504	2005	2506	3008	3509	4010	4511	5013	5514	7519
7.00	—	227	364	455	682	909	1137	1364	1819	2274	2728	3183	3638	4093	4547	5002	6821
7.94	5/16	200	321	401	601	802	1002	1203	1604	2004	2405	2806	3207	3608	4009	4410	6013
8.00	—	199	318	398	597	796	995	1194	1592	1989	2387	2785	3183	3581	3979	4377	5968
9.00	—	177	283	354	531	707	884	1061	1415	1768	2122	2476	2829	3183	3537	3890	5305
9.53	3/8	167	267	334	501	668	835	1002	1336	1670	2004	2338	2672	3006	3340	3674	5010
10.00	—	159	255	318	477	637	796	955	1273	1592	1910	2228	2546	2865	3183	3501	4775
11.11	7/16	143	229	287	430	573	716	860	1146	1433	1719	2006	2292	2579	2865	3152	4298
12.00	—	133	212	265	398	531	663	796	1061	1326	1592	1857	2122	2387	2653	2918	3979
12.70	1/2	125	201	251	376	501	627	752	1003	1253	1504	1754	2005	2256	2506	2757	3760
14.00	—	114	182	227	341	455	568	682	909	1137	1364	1592	1819	2046	2274	2501	3410
14.29	9/16	111	178	223	334	446	557	668	891	1114	1337	1559	1782	2005	2228	2450	3341
15.00	—	106	170	212	318	424	531	637	849	1061	1273	1485	1698	1910	2122	2334	3183
15.88	5/8	100	160	200	301	401	501	601	802	1002	1203	1403	1604	1804	2004	2205	3007
16.00	—	99	159	199	298	398	497	597	796	995	1194	1393	1592	1790	1989	2188	2984
17.46	11/16	91	146	182	273	365	456	547	729	912	1094	1276	1458	1641	1823	2005	2735
18.00	—	88	141	177	265	354	442	531	707	884	1061	1238	1415	1592	1768	1945	2653
19.05	3/4	84	134	167	251	334	418	501	668	835	1003	1170	1337	1504	1671	1838	2506
20.00	—	80	127	159	239	318	398	477	637	796	955	1114	1273	1432	1592	1751	2387
24.00	—	66	106	133	199	265	332	398	531	663	796	928	1061	1194	1326	1459	1989
25.00	—	64	102	127	191	255	318	382	509	637	764	891	1019	1146	1273	1401	1910
27.00	—	59	94	118	177	236	295	354	472	589	707	825	943	1061	1179	1297	1768
30.00	—	53	85	106	159	212	265	318	424	531	637	743	849	955	1061	1167	1592
32.00	—	50	80	99	149	199	249	298	398	497	597	696	796	895	995	1094	1492
36.00	—	44	71	88	133	177	221	265	354	442	531	619	707	796	884	973	1326
40.00	—	40	64	80	119	159	199	239	318	398	477	557	637	716	796	875	1194
50.00	—	32	51	64	95	127	159	191	255	318	382	446	509	573	637	700	955



INFORMACIÓN TÉCNICA GENERAL

Dureza y resistencia a la tracción

HV	HRC	HB	Resistencia	
			N/mm ²	Toneladas/sq. in.
Vickers	Rockwell	Brinell		
940	68	—	—	—
900	67	—	—	—
864	66	—	—	—
829	65	—	—	—
800	64	—	—	—
773	63	—	—	—
745	62	—	—	—
720	61	—	—	—
698	60	—	—	—
675	59	—	—	—
655	58	—	2200	142
650	—	618	2180	141
640	—	608	2145	139
639	57	607	2140	138
630	—	599	2105	136
620	—	589	2070	134
615	56	584	2050	133
610	—	580	2030	131
600	—	570	1995	129
596	55	567	1980	128
590	—	561	1955	126
580	—	551	1920	124
578	54	549	1910	124
570	—	542	1880	122
560	53	532	1845	119
550	—	523	1810	117
544	52	517	1790	116
540	—	513	1775	115
530	—	504	1740	113
527	51	501	1730	112
520	—	494	1700	110
514	50	488	1680	109
510	—	485	1665	108
500	—	475	1630	105
497	49	472	1620	105
490	—	466	1595	103
484	48	460	1570	102
480	—	456	1555	101
473	47	449	1530	99
470	—	447	1520	98
460	—	437	1485	96
458	46	435	1480	96
450	—	428	1455	94
446	45	424	1440	93
440	—	418	1420	92

HV	HRC	HB	Resistencia	
			N/mm ²	Toneladas/sq. in.
Vickers	Rockwell	Brinell		
434	44	413	1400	91
423	43	402	1360	88
413	42	393	1330	86
403	41	383	1300	84
392	40	372	1260	82
382	39	363	1230	80
373	38	354	1200	78
364	37	346	1170	76
355	36	337	1140	74
350	—	333	1125	73
345	35	328	1110	72
340	—	323	1095	71
336	34	319	1080	70
330	—	314	1060	69
327	33	311	1050	68
320	—	304	1030	67
317	32	301	1020	66
310	31	295	995	64
302	30	287	970	63
300	—	285	965	62
295	—	280	950	61
293	29	278	940	61
290	—	276	930	60
287	28	273	920	60
285	—	271	915	59
280	27	266	900	58
275	—	261	880	57
272	26	258	870	56
270	—	257	865	56
268	25	255	860	56
265	—	252	850	55
260	24	247	835	54
255	23	242	820	53
250	22	238	800	52
245	—	233	785	51
243	21	231	780	50
240	—	228	770	50
235	—	223	755	49
230	—	219	740	48
225	—	214	720	47
220	—	209	705	46
215	—	204	690	45
210	—	199	675	44
205	—	195	660	43
200	—	190	640	41



**BROCAS DE CABEZA INTERCAMBIABLE
BROCAS DE PLAQUITA INTERCAMBIABLE**





MECANIZADO DE AGUJEROS: ÍNDICE GENERAL

6		WMG E ISO 13399
12	BROCAS	INSTRUCCIONES
15		BROCAS DE METAL DURO INTEGRAL
66		BROCAS DE HSS
176		INFORMACIÓN TÉCNICA
186		ACEITES DE CORTE
190		ESCARIADORES Y AVELLANADORES
264	BROCAS DE PLAQUITA INTERCAMBIABLE	INSTRUCCIONES
271		BROCAS HYDRA
297		INFORMACIÓN TÉCNICA
307		BROCAS DE PLAQUITA INTERCAMBIABLE
327		INFORMACIÓN TÉCNICA
350	SISTEMAS DE MANDRILADO	INSTRUCCIONES
359		CABEZALES DE MANDRINADO
376		ACCESORIOS DE MANDRINADO
381		PLAQUITAS DE CORTE
404		ÚTILES DE SUJECCIÓN
418		KITS DE MANDRINADO
429		INFORMACIÓN TÉCNICA



PLAQUITAS DE CORTE: PÁGINA RESUMEN



1

SCET

	IC	D1	L	S
	[mm]	[mm]	[mm]	[mm]
0502	5.556	2.40	5.56	2.38
0602	6.350	2.90	6.35	2.38
0703	7.937	3.50	7.94	3.18
09T3	9.525	4.50	9.53	3.97
1204	12.700	5.60	12.70	4.76
1505	15.875	5.60	15.88	5.56

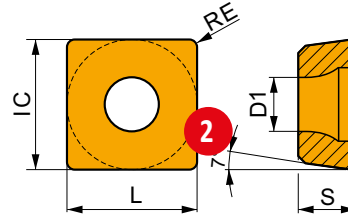

Valores de inicio adecuados para la velocidad de corte (vc), avance (f) y profundidad de corte (ap). Consulte nuestra APP Calculadora de mecanizado para obtener más cálculos.

Product	RE [mm]	P			M			K			N			S			H		
		vc [m/min]	f [mm/rev]	ap [mm]	vc [m/min]	f [mm/rev]	ap [mm]	vc [m/min]	f [mm/rev]	ap [mm]	vc [m/min]	f [mm/rev]	ap [mm]	vc [m/min]	f [mm/rev]	ap [mm]			

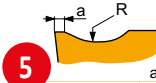

Geometría UD con diseño universal para plaquitas periféricas.

SCET 050204-UD	0,12
SCET 060204-UD	0,15
SCET 070308-UD	0,15
SCET 09T308-UD	0,15
SCET 120408-UD	0,20
SCET 150512-UD	0,20

SCET 050204-UD	D8330	0.4	165	0.08	-	-	-	-	155	0.08	-	-	-	-	-	-	-	-
	D9335	0.4	240	0.08	-	-	-	-	225	0.08	-	-	-	-	-	-	-	-
SCET 060204-UD	D8330	0.4	165	0.11	-	-	-	-	155	0.11	-	-	-	-	-	-	-	-
	D9335	0.4	240	0.11	-	-	-	-	225	0.11	-	-	-	-	-	-	-	-
SCET 070308-UD	D8330	0.8	165	0.13	-	-	-	-	155	0.13	-	-	-	-	-	-	-	-
	D9335	0.8	240	0.13	-	-	-	-	225	0.13	-	-	-	-	-	-	-	-
SCET 09T308-UD	D8330	0.8	165	0.14	-	-	-	-	155	0.14	-	-	-	-	-	-	-	-
	D9335	0.8	240	0.14	-	-	-	-	225	0.14	-	-	-	-	-	-	-	-
SCET 120408-UD	D8330	0.8	165	0.16	-	-	-	-	155	0.16	-	-	-	-	-	-	-	-
	D9335	0.8	240	0.16	-	-	-	-	225	0.16	-	-	-	-	-	-	-	-
SCET 150512-UD	D8330	1.2	165	0.18	-	-	-	-	155	0.18	-	-	-	-	-	-	-	-
	D9335	1.2	240	0.18	-	-	-	-	225	0.18	-	-	-	-	-	-	-	-

SCET120408-UD:D9335

Utilice el código de especificación completo de la plaqueta de corte para realizar el pedido.

- Calidad
- Incluye dos puntos
- Código ISO para la plaqueta de corte



PLAQUITAS DE CORTE: PÁGINA RESUMEN

Pos.	Descripción
1	Denominación de la plaquita de corte
2	Representación esquemática de la plaquita de corte
3	Tabla de tamaños de plaquita de corte (mm)
4	Imagen representativa de una plaquita de corte
5	Perfil del filo de corte principal
6	Símbolos: características especiales y tipo de filo de corte

Pos.	Descripción
7	Código ISO para la plaquita de corte
8	Calidad
9	Radios de plaquita de corte (mm)
10	Descripción de la geometría
11	Área de aplicación de la plaquita de corte



BROCAS DE PLAQUITA INTERCAMBIABLE: PÁGINA RESUMEN

1 **802D**



PRAMET 3 S



Cuerpo de Broca 802D de placa intercambiable 2XD con Refrigeración Interna

Cuerpo de broca de plaquitas intercambiables de alto rendimiento para taladrar agujeros ciegos y pasantes. Potencialmente también taladrado de agujeros cruzados, descentrados y en paquetes de chapas, interpolación helicoidal, fresado axial (plunge), taladrado en superficies cóncavas o en ángulo, taladrado con cortes interrumpidos, achaflanado y mandrinado. Disponible desde Ø15 hasta Ø40 mm en 2xD.

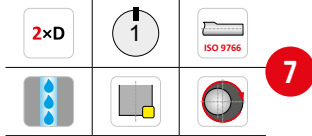
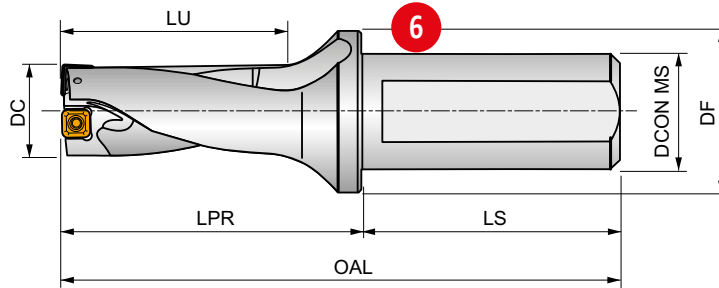

Product	DC	APMX	OAL	LPR	LS	LU	DCON MS	DF	\bar{D}	D^+					
	[mm]	[mm]	[mm]	[mm]	[mm]	[mm]	[mm]	[mm]	[mm]	[mm]					
802D-15-30-S25	15	30.00	121	65	56	34.5	25	35	0.25	0.35	EP253253	GI300	GI313	0.30	HM001
802D-16-32-S25	16	32.00	123	67	56	37	25	35	0.45	0.45	EP253253	GI300	GI313	0.30	HM001
802D-17-34-S25	17	34.00	125	69	56	39.5	25	35	0.50	0.50	EP253253	GI301	GI314	0.31	HM002
802D-18-36-S25	18	36.00	127	71	56	42	25	35	0.35	0.25	EP253253	GI301	GI314	0.31	HM002
802D-19-38-S25	19	38.00	129	73	56	44.5	25	35	0.15	0.45	EP253253	GI301	GI314	0.32	HM002

GI300	XPET 0502AP	SCET 050204-UD
GI301	XPET 0602AP	SCET 050204-UD
GI302	XPET 0602AP	SCET 060204-UD
GI303	XPET 0703AP	SCET 060204-UD
GI304	XPET 0703AP	SCET 070308-UD
GI305	XPET 0903AP	SCET 070308-UD
GI306	XPET 0903AP	SCET 09T308-UD
GI307	XPET 11T3AP	SCET 09T308-UD
GI308	XPET 11T3AP	SCET 120408-UD
GI309	XPET 12T3AP	SCET 120408-UD
GI313	XPET 0502AP-SD	SCET 050204-SD
GI314	XPET 0602AP-SD	SCET 050204-SD
GI315	XPET 0602AP-SD	SCET 060204-SD
GI316	XPET 0703AP-SD	SCET 060204-SD
GI317	XPET 0703AP-SD	SCET 070308-SD
GI318	XPET 0903AP-SD	SCET 070308-SD
GI319	XPET 0903AP-SD	SCET 09T308-SD
GI320	XPET 11T3AP-SD	SCET 09T308-SD
GI321	XPET 11T3AP-SD	SCET 120408-SD
GI322	XPET 12T3AP-SD	SCET 120408-SD

GI300	XPET 0502AP	SCET 050204-UD
GI301	XPET 0602AP	SCET 050204-UD
GI302	XPET 0602AP	SCET 060204-UD
GI303	XPET 0703AP	SCET 060204-UD



BROCAS DE PLAQUITA INTERCAMBIABLE: PÁGINA RESUMEN

Pos.	Descripción	Pos.	Descripción
1	Denominación de la broca	11	Ajuste radial (mm)
2	Recomendaciones de grupo de material	12	Manguito ajustable
3	Sistema de fijación de la plaquita de corte	13	Grupo de plaquitas de corte compatibles con rompevirutas UD ^{1),2)}
4	Descripción de la herramienta	14	Grupo de plaquitas de corte compatibles con rompevirutas SD ^{1),2)}
5	Imagen	15	Peso (kg)
6	Representación esquemática de la herramienta	16	Grupo de piezas de repuesto ¹⁾
7	Características del producto	17	Plaquitas de corte compatibles con rompevirutas UD
8	Aplicaciones del producto	18	Plaquitas de corte compatibles con rompevirutas SD
9	Código de la herramienta	19	Piezas de repuesto
10	Dimensiones de la herramienta		

¹⁾ El código de grupo de plaquitas de corte compatibles y piezas de repuesto se utiliza únicamente con fines de guía dentro de este catálogo. No se puede utilizar para pedidos.

²⁾ Las plaquitas de corte externas (SCET) e internas (XPET) deben tener siempre el mismo rompevirutas (AVISO: El rompevirutas UD no está visiblemente incluido en la denominación de las plaquitas de corte XPET, p. ej. XPET 0502AP); la información necesaria para la correcta elección del rompevirutas (UD o SD) se puede encontrar en el embalaje de la plaquita de corte.



1 **H851**



Cuerpo HYDRA 1.5XD, con Refrigeración Interna, Recubrimiento Niquelado Brillante

Se utiliza con cabezas HYDRA R950, R960 y R970. Se pueden utilizar varios diámetros de cabeza con el mismo cuerpo. Los agujeros de refrigerante alineados con las cabezas de corte ofrecen una refrigeración eficiente. El mango con brida evita que la broca se mueva en el soporte. La superficie brillante niquelada protege del óxido y la corrosión y mejora la evacuación de virutas.

2

HYDRA

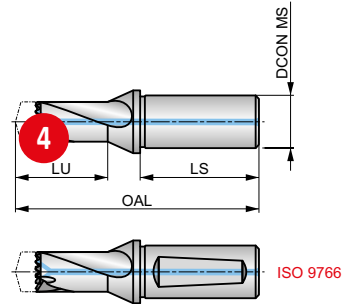

HSS	DORMER	1.5xD
Bright Ni	ISO 9766	R

5

Cuatro (4) tornillos y un (1) destornillador se incluyen en cada cuerpo de broca, DCON MS tolerancia h6.

Product	DCONMS	DCON MS	LU	OAL	LS	ADINTMS
	[inch]	[mm]	[mm]	[mm]	[mm]	
H85131/64	5/8	15.88	25.50	88.5	47.6	Cylindrical
H8511/2	5/8	15.88	25.80	88.8	47.6	Cylindrical
H85117/32	5/8	15.88	30.90	93.9	47.6	Cylindrical
H85112.0	-	16.00	25.50	88.5	48.0	ISO 9766
H85112.5	-	16.00	25.80	88.8	48.0	ISO 9766
H85113.0	-	16.00	27.00	90.0	48.0	ISO 9766
H85114.0	-	16.00	30.90	93.9	48.0	ISO 9766
H8519/16	3/4	19.05	30.30	93.9	50.8	Cylindrical
H85139/64	3/4	19.05	32.30	97.3	50.8	Cylindrical
H85111/16	3/4	19.05	32.30	99.9	50.8	Cylindrical
H85116	3/4	19.05	39.00	101.4	50.8	Cylindrical
H85123/32	3/4	19.05	39.00	104.0	50.8	Cylindrical
H85115.0	-	20.00	32.30	97.3	50.0	ISO 9766
H85116.0	-	20.00	34.90	99.9	50.0	ISO 9766
H85117.0	-	20.00	36.40	101.4	50.0	ISO 9766
H85118.0	-	20.00	39.00	104.0	50.0	ISO 9766
H85119.0	-	25.00	40.40	111.4	56.0	ISO 9766
H85120.0	-	25.00	43.00	114.0	56.0	ISO 9766
H85121.0	-	25.00	44.50	115.5	56.0	ISO 9766

6

7

Pos.	Descripción
1	Denominación de la broca
2	Descripción del producto
3	Imagen
4	Representación esquemática de la herramienta

Pos.	Descripción
5	Características del producto
6	Código de producto
7	Dimensiones del producto



CABEZAS INTERCAMBIABLES Y BROCAS DE PLAQUITA INTERCAMBIABLE: RESUMEN DE SÍMBOLOS

SÍMBOLOS GENERALES

ÁNGULO DE APLICACIÓN

 Uso principal

 Uso posible

 Punta de la broca 140°

GRUPO DE NORMAS BÁSICO (BSG)

DENOMINACIÓN DE LA FIJACIÓN

RECUBRIMIENTO

 Normas Dormer

 S = fijación por tornillo

 Niquelado brillante

 Recubrimiento especial de TiAlN (+ silicón + cromo)

PROPIEDADES DE SUMINISTRO DE REFRIGERANTE (CSP)

CLASE DE TOLERANCIA DEL DIÁMETRO DE CORTE(TCDC)

DIRECCIÓN DE CORTE

 Refrigeración interna

 h7 - Clase de tolerancia

 Giro/corte a la derecha

CARACTERÍSTICAS GENERALES DE LAS HERRAMIENTAS

 1 diente efectivo por revolución

 Posibilidad de uso para mecanizado excéntrico

 Diseño monobloque

 Mango universal

FILO DE CORTE DE LA PLAQUITA DE CORTE

CARACTERÍSTICAS DE LA PLAQUITA DE CORTE

CÓDIGO DE MATERIAL (BMC)

 Filo redondeado con faceta

 Para materiales difíciles de mecanizar (viruta larga)

 Metal duro

 Condiciones de trabajo pesadas

 Acero rápido

 Uso universal

OPERACIONES DE TALADRADO

 Mandrinado de agujeros ciegos

 Taladrado a través de un agujero existente

 Achaflanado (biselado)

 Taladrado de agujeros ciegos

 Taladrado de materiales apilados

 Corte interrumpido

 Mandrilado

 Taladrado en una superficie curva

 Mandrilado de agujeros pasantes

 Mandrilado a través de agujeros transversales

 Taladrado en una superficie inclinada

 Taladrado de agujeros pasantes

 Mandrilado hasta una escuadra

 Mandrilado de interpolación helicoidal

 Taladrado de uniones soldadas

 Salida de broca en superficie inclinada

 Taladrado de interpolación helicoidal



CABEZAS INTERCAMBIABLES Y BROCAS DE PLAQUITA INTERCAMBIABLE: RESUMEN DE SÍMBOLOS

OTROS SÍMBOLOS

 Par de apriete del tornillo (Nm)

MANGO

 Mango cilíndrico con ala

 DIN 6535 - Mango HB (Weldon) o HE (Whistle Notch)

 ISO 9766 - Mango cilíndrico (con o sin cara plana)

PÁGINAS TÉCNICAS

 Avance (mm/rev)

 Velocidad de corte muy alta (condiciones estables)

 Velocidad de corte alta, alta rigidez del sistema (condiciones estables)

 Velocidad de corte media, rigidez del sistema limitada (corte ligeramente interrumpido)

 Velocidad de corte media, rigidez del sistema limitada (corte ligeramente interrumpido)

 Velocidad de corte baja, rigidez del sistema baja (corte interrumpido)

 Velocidad de corte muy baja, rigidez del sistema muy baja (condiciones muy inestables)

RELACIÓN ENTRE LONGITUD Y DIÁMETRO ÚTIL (ULDR)

1.5xD Relación entre profundidad de la herramienta y diámetro útil 1,5xD

12xD Relación entre profundidad de la herramienta y diámetro útil 12xD

3xD Relación entre profundidad de la herramienta y diámetro útil 3xD

5xD Relación entre profundidad de la herramienta y diámetro útil 5xD

8xD Relación entre profundidad de la herramienta y diámetro útil 8xD

2xD Relación entre profundidad de la herramienta y diámetro útil 2xD

4xD Relación entre profundidad de la herramienta y diámetro útil 4xD



BROCAS HYDRA



HYDRA

BROCAS DE CABEZA INTERCAMBIABLE DE ALTO RENDIMIENTO

Hemos complementado nuestra gama de taladrado Hydra con nuevas longitudes de cuerpo: 12xD para aplicaciones de agujeros más profundos y 1,5xD para una rigidez mejorada en agujeros poco profundos.

Con ellas se completa la gama de brocas que montan toda la familia de cabezas de metal duro para el mecanizado de acero, acero inoxidable y fundición.

CARACTERÍSTICAS Y BENEFICIOS

- **Alto rendimiento constante**, incluso tras numerosos cambios de cabeza.
- **Reducción de costes de inventario** – un mismo cuerpo es compatible con cabezas de metal duro de distinto tamaño.
- **Versátil** – el mango cilíndrico con planos de apriete permite su montaje en múltiples portaherramientas.
- **Cambio de cabeza fácil y rápido** con mínimas interrupciones en el proceso de producción. Las cabezas se pueden cambiar sin desmontar la broca de la máquina.
- El acoplamiento exacto de la cabeza y el cuerpo maximiza la rigidez de la herramienta para una **superior precisión del agujero** y tolerancias más precisas.

MATERIAL

SUSTRATO MICROGRANO PREMIUM (cabeza)

- El sustrato micrograno proporciona una excelente combinación de dureza y tenacidad que se traduce en una alta resistencia al desgaste y mayor vida de filo.

ACERO ENDURECIDO (cuerpo)

- Acero endurecido con niquelado de alto brillo para una mayor resistencia frente al desgaste y la corrosión.

RECUBRIMIENTO

EL RECUBRIMIENTO A BASE DE NITRURO DE TITANIO Y ALUMINIO PROPORCIONA:

- Alta tenacidad y resistencia a la oxidación.
- Protección antidesgaste elevada en materiales abrasivos como la fundición.
- Alta dureza a altas temperaturas generadas al taladrar fundiciones.
- Productividad y vida de herramienta incrementada.

TIPOS DE CABEZA



R950

ACERO



R960

ACERO
INOXIDABLE



R970

FUNDICIÓN



HYDRA

BROCAS DE CABEZA INTERCAMBIABLE DE ALTO RENDIMIENTO

GEOMETRÍA

DISEÑO DE ESQUINA

- Un diseño de esquina robusto incrementa la estabilidad durante el taladrado y reduce las fuerzas producidas durante la rotura de la superficie de salida.
- Esto mejora la calidad de la superficie de salida y ayuda a evitar pequeñas roturas a la salida del agujero que suelen ocurrir al taladrar materiales granulares.

GEOMETRÍA DE PUNTA

- La punta adelgazada con un ángulo de 140 grados proporciona una buena capacidad autocentrante y bajas fuerzas de empuje taladrando en muchos materiales.

UNA GAMA COMPLETA

- Disponible en longitudes de 1.5xD, 3xD, 5xD, 8xD y 12xD con agujeros de refrigeración para mejorar la eficiencia del corte y la evacuación de viruta, aumentando la productividad
- Metrico: de 12,00 mm a 42.00 mm.
- Fraccional: de 15/32 de pulgada a 1,5/8 de pulgada.
- Los mejores resultados se obtienen con portaherramientas hidráulicos. También se pueden usar los portaherramientas de tipo ER y Weldon.

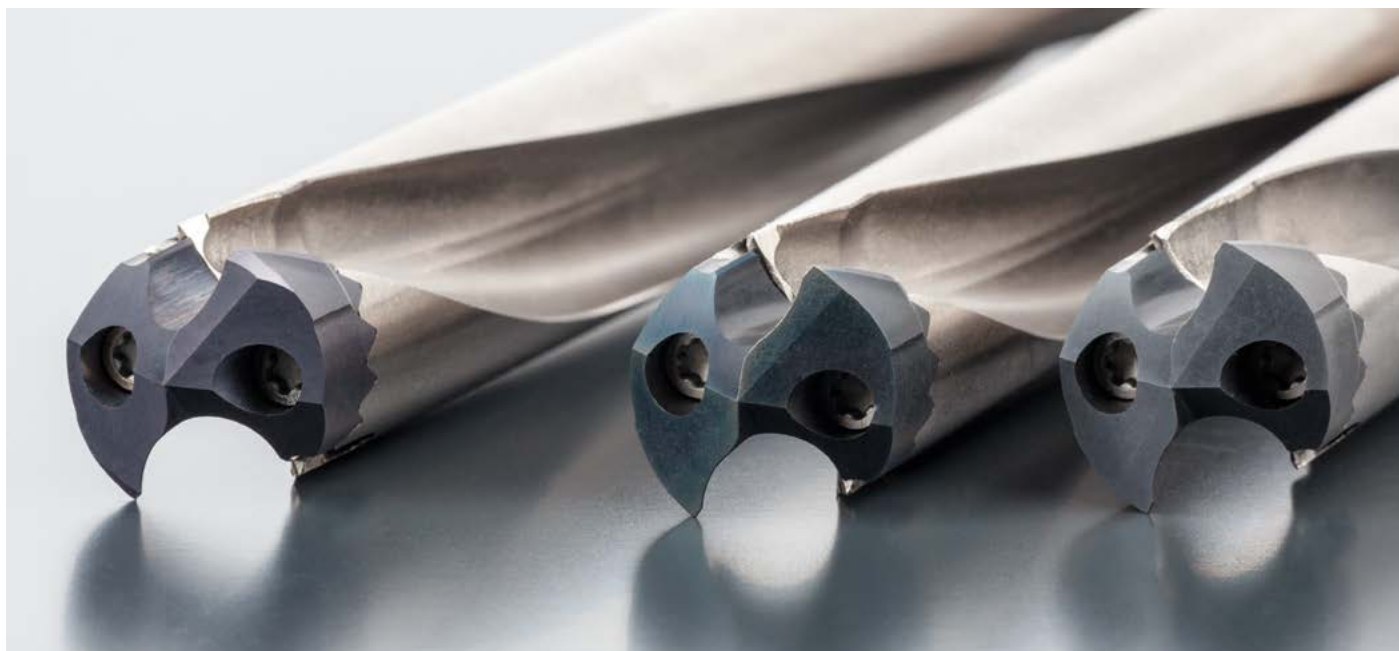

LONGITUDES DE CUERPO

1.5xD



3xD



5xD



8xD



12xD





BROCAS HYDRA: NAVEGADOR DE MATERIALES DE HERRAMIENTA



Materiales de herramientas

Acero rápido		Se trata de un acero rápido de aleación media que presenta una buena maquinabilidad y un excelente rendimiento. El HSS presenta características de dureza, tenacidad y resistencia al desgaste que lo hacen atractivo en una amplia variedad de aplicaciones, por ejemplo en brocas y machos de roscar.
---------------------	-----------------------------------------------------------------------------------	---------------------------------------------------------------------------------------------------------------------------------------------------------------------------------------------------------------------------------------------------------------------------------------------------------

Materiales de metal duro

Materiales de metal duro (o materiales duros)		<p>Un sustrato pulvimetalúrgico sinterizado, formado por un compuesto de carburo metálico con metal aglutinante. La materia prima más importante es el carburo de tungsteno (WC). El carburo de tungsteno contribuye al endurecimiento del material. El carburo de tántalo (TaC), el carburo de titanio (TiC) y el carburo de niobio (NbC) complementan al WC y adaptan sus propiedades según se desee. Estos tres materiales se conocen como carburos cúbicos. El cobalto (Co) actúa como aglutinante y mantiene el material unido.</p> <p>Los materiales de carburo suelen caracterizarse por su alta resistencia a la compresión, su elevada dureza y, por tanto, su alta resistencia al desgaste, pero también por su limitada resistencia a la flexión y por su tenacidad. El carburo se utiliza en machos de roscar, escariadores, fresas, brocas y fresas de roscar.</p>
------------------------------------------------------	-----------------------------------------------------------------------------------	---------------------------------------------------------------------------------------------------------------------------------------------------------------------------------------------------------------------------------------------------------------------------------------------------------------------------------------------------------------------------------------------------------------------------------------------------------------------------------------------------------------------------------------------------------------------------------------------------------------------------------------------------------------------------------------------------------------------------------------------------------------------------------------------------------------------------------------------------------------------------------

Recubrimientos superficiales

Niquelado brillante		La superficie niquelada brillante protege el cuerpo de acero endurecido de la oxidación, la corrosión y también mejora la evacuación de las virutas.
Ti-phon (TiAlCrSiN)		El recubrimiento Ti-phon es un recubrimiento similar al de TiAlN, pero con la adición de cromo (Cr) y silicio (Si) especialmente formulados para los cabezales Hydra, a fin de evitar la formación de filos de aportación y mejorar en gran medida la evacuación de las virutas. Este recubrimiento presenta una alta dureza en caliente, una gran resistencia a la oxidación y una lubricidad superior cuando se utiliza en herramientas para aplicaciones de mecanizado que implican fuertes tensiones mecánicas y térmicas, altas velocidades y altos avances. Estas propiedades del recubrimiento se traducen en una resistencia al desgaste y una fuerza del filo superiores.



DORMER PRAMET



TODAS LAS HERRAMIENTAS

La aplicación de cálculo de mecanizado incluye todas nuestras herramientas rotativas e intercambiables: ¡más de **40 000** productos en total! Independientemente del tipo de mecanizado que necesite, tenemos la solución adecuada para usted.

Simplemente fiables.

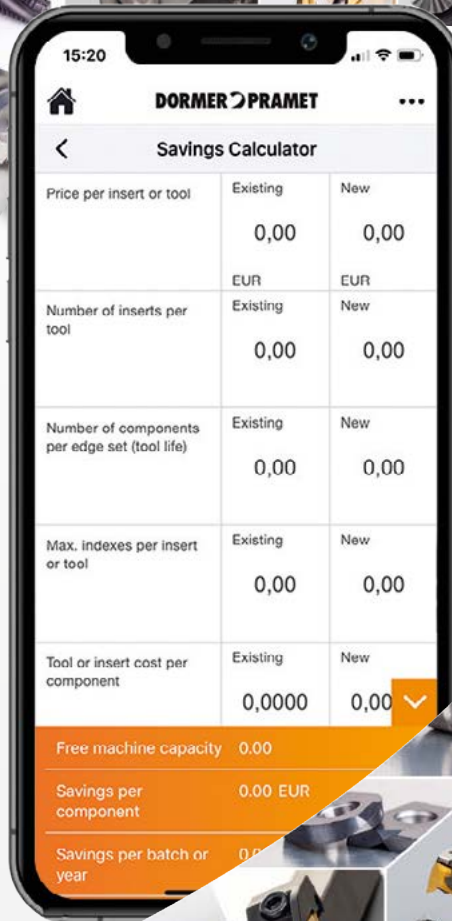











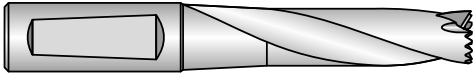















Código de Material (BMC)		HM	HM	HM	HSS	HSS	HSS	HSS	HSS				
Grupo básico estándar (BSG)													
Longitud Útil (ULDR)					1.5×D	3×D	5×D	8×D	12×D				
Ángulo de aplicación													
Recubrimiento													
Mango													
Mano (dirección de corte)													
Refrigeración (CSP)													
Código de Familia de Producto		R950	R960	R970	H851	H853	H855	H858	H8512	H860	H861		
		12.00 - 42.00, 15/32 - 1.5/8	12.00 - 30.50, 15/32 - 1.3/16	12.00 - 42.00, 15/32 - 1.5/8	12.00 - 30.50, 15/32 - 1.3/16	12.00 - 42.50, 15/32 - 1.5/8	12.00 - 42.50, 15/32 - 1.5/8	13.50 - 42.50, 35/64 - 1.5/8	13.50 - 25.65, 35/64 - 1.1/64	N1 - N7	N1 - N6		
		281	283	285	287	289	291	293	294	295	296		
P	P1	<input checked="" type="checkbox"/>	<input type="checkbox"/>										
	P2	<input type="checkbox"/>	<input checked="" type="checkbox"/>										
	P3	<input type="checkbox"/>											
	P4	<input type="checkbox"/>											
M	M1		<input type="checkbox"/>										
	M2		<input type="checkbox"/>										
	M3		<input type="checkbox"/>										
	M4		<input type="checkbox"/>										
K	K1		<input type="checkbox"/>	<input type="checkbox"/>									
	K2	<input type="checkbox"/>	<input checked="" type="checkbox"/>	<input type="checkbox"/>									
	K3	<input type="checkbox"/>	<input checked="" type="checkbox"/>	<input type="checkbox"/>									
	K4	<input type="checkbox"/>	<input checked="" type="checkbox"/>	<input type="checkbox"/>									
	K5	<input type="checkbox"/>	<input checked="" type="checkbox"/>	<input type="checkbox"/>									
N	N1												
	N2												
	N3												
	N4												
	N5												
S	S1		<input checked="" type="checkbox"/>										
	S2		<input checked="" type="checkbox"/>										
	S3		<input checked="" type="checkbox"/>										
	S4		<input checked="" type="checkbox"/>										
H	H1												
	H2												
	H3												
	H4												

■ Primera Opción Opción Alternativa



BROCAS DE ALTO RENDIMIENTO CON CABEZA INTERCAMBIABLE

Configuración										
	DC	H851 1.5×D	H853 3×D	H855 5×D	H858 8×D	H8512 12×D	R950	R960	R970	H860
						 DC	 DC	 DC		
Rango	12.00 – 30.50 15/32" – 1.3/16"	12.00 – 42.50 15/32" – 1.5/8"	12.00 – 42.50 15/32" – 1.5/8"	13.50 – 42.50 35/64" – 1.5/8"	13.50 – 25.65 35/64" – 1.1/64"	12.00 – 42.00 15/32" – 1.5/8"	12.00 – 30.50 15/32" – 1.3/16"	12.00 – 42.00 15/32" – 1.5/8"	N1 – N7	N1 – N6
Páginas	 287	 289	 291	 293	 294	 281	 283	 285	 295	 296

DC	H851 1.5×D	H853 3×D	H855 5×D	H858 8×D	H8512 12×D	R950	R960	R970	H860	H861
15/32"						R95015/32	R96015/32	R97015/32		
12.0						R95012.0	R96012.0	R97012.0		
12.1	H85112.0	H85312.0	H85512.0	–	–	R95012.1	R96012.1	R97012.1		
12.2	H85131/64	H85331/64	H85531/64			R95012.2	R96012.2	R97012.2		
31/64"						R95031/64	R96031/64	R97031/64		
12.5						R95012.5	R96012.5	R97012.5		
12.6						R95012.6	R96012.6	R97012.6		
1/2"	H85112.5	H85312.5	H85512.5	–	–	R9501/2	R9601/2	R9701/2		
12.8	H8511/2	H8531/2	H8551/2			R95012.8	R96012.8	R97012.8		
12.9						R95012.9	R96012.9	R97012.9		
13.0						R95013.0	R96013.0	R97013.0		
33/64"						R95033/64	R96033/64	R97033/64		
13.2	H85113.0	H85313.0	H85513.0	–	–	R95013.2	R96013.2	R97013.2		
17/32"	H85117/32	H85317/32	H85517/32			R95017/32	R96017/32	R97017/32		
13.5						R95013.5	R96013.5	R97013.5		
13.6						R95013.6	R96013.6	R97013.6		
13.7						R95013.7	R96013.7	R97013.7		
13.8						R95013.8	R96013.8	R97013.8		
35/64"						R95035/64	R96035/64	R97035/64		
14.0	H85114.0	H85314.0	H85514.0	H85814.0	H851214.0	R95014.0	R96014.0	R97014.0	H860N1	H861N1
14.1	H8519/16	H8539/16	H8559/16			R95014.1	R96014.1	R97014.1		
14.2						R95014.2	R96014.2	R97014.2		
9/16"						R9509/16	R9609/16	R9709/16		
14.5						R95014.5	R96014.5	R97014.5		
14.6						R95014.6	R96014.6	R97014.6		
37/64"						R95037/64	R96037/64	R97037/64		
14.7						R95014.7	R96014.7	R97014.7		
14.8						R95014.8	R96014.8	R97014.8		
15.0						R95015.0	R96015.0	R97015.0		
19/32"						R95019/32	R96019/32	R97019/32		
15.1	H85115.0	H85315.0	H85515.0	H85815.0	H851215.0	R95015.1	R96015.1	R97015.1		
15.2	H85139/64	H85339/64	H85539/64			R95015.2	R96015.2	R97015.2		
15.24						R95015.24	R96015.24	R97015.24		
39/64"						R95039/64	R96039/64	R97039/64		
15.5						R95015.5	R96015.5	R97015.5		



BROCAS DE ALTO RENDIMIENTO CON CABEZA INTERCAMBIABLE

DC	H851 1.5xD	H853 3xD	H855 5xD	H858 8xD	H8512 12xD	R950	R960	R970	H860	H861							
15.6	H85116.0	H85316.0	H85516.0	H85816.0	H851216.0	R95015.6	R96015.6	R97015.6	H860N2	H861N2							
15.7						R95015.7	R96015.7	R97015.7									
5/8"						R9505/8	R9605/8	R9705/8									
16.0						R95016.0	R96016.0	R97016.0									
16.08						R95016.08	R96016.08	R97016.08									
16.1						H85141/64	H85341/64	H85541/64			R95016.1	R96016.1	R97016.1				
16.2						R95016.2	R96016.2	R97016.2									
16.3						R95016.3	R96016.3	R97016.3									
41/64"						R95041/64	R96041/64	R97041/64									
16.5						R95016.5	R96016.5	R97016.5									
16.6	H85117.0	H85317.0	H85517.0	H85817.0	H851217.0	R95016.6	R96016.6	R97016.6	H860N2	H861N2							
21/32"						R95021/32	R96021/32	R97021/32									
16.7						R95016.7	R96016.7	R97016.7									
17.0						R95017.0	R96017.0	R97017.0									
43/64"						H851111/16	H85311/16	H85511/16			R95043/64	R96043/64	R97043/64				
17.1						R95017.1	R96017.1	R97017.1									
17.2						R95017.2	R96017.2	R97017.2									
11/16"						R95011/16	R96011/16	R97011/16									
17.5						R95017.5	R96017.5	R97017.5									
17.6						H85118.0	H85318.0	H85518.0			H85818.0	H851218.0	R95017.6	R96017.6	R97017.6	H860N3	H861N3
17.7	R95017.7	R96017.7	R97017.7														
45/64"	R95045/64	R96045/64	R97045/64														
18.0	H85123/32	H85323/32	H85523/32	R95018.0	R96018.0				R97018.0								
18.1	R95018.1	R96018.1	R97018.1														
18.2	R95018.2	R96018.2	R97018.2														
23/32"	R95023/32	R96023/32	R97023/32														
18.5	R95018.5	R96018.5	R97018.5														
18.6	H85119.0	H85319.0	H85519.0	H85819.0	H851219.0				R95018.6	R96018.6			R97018.6	H860N3	H861N3		
47/64"									R95047/64	R96047/64			R97047/64				
18.7						R95018.7	R96018.7	R97018.7									
18.9						R95018.9	R96018.9	R97018.9									
19.0						R95019.0	R96019.0	R97019.0									
3/4"						R9503/4	R9603/4	R9703/4									
19.1						H85149/64	H85349/64	H85549/64	R95019.1	R96019.1	R97019.1						
19.2						R95019.2	R96019.2	R97019.2									
19.25						R95019.25	R96019.25	R97019.25									
19.3						R95019.3	R96019.3	R97019.3									
19.35	R95019.35	R96019.35	R97019.35														
49/64"	R95049/64	R96049/64	R97049/64														
19.5	R95019.5	R96019.5	R97019.5														
19.6	H85120.0	H85320.0	H85520.0	H85820.0	H851220.0	R95019.6	R96019.6	R97019.6	H860N4	H861N3							
19.7						R95019.7	R96019.7	R97019.7									
25/32"						H85151/64	H85351/64	H85551/64			R95025/32	R96025/32	R97025/32				
20.0						R95020.0	R96020.0	R97020.0									
51/64"						R95051/64	R96051/64	R97051/64									
20.5						R95020.5	R96020.5	R97020.5									
13/16"						R95013/16	R96013/16	R97013/16									
21.0						R95021.0	R96021.0	R97021.0									
53/64"						H85121.0	H85321.0	H85521.0			R95053/64	R96053/64	R97053/64				
27/32"						H85127/32	H85327/32	H85527/32			R95027/32	R96027/32	R97027/32				
21.5	R95021.5	R96021.5	R97021.5														
55/64"	H85122.0	H85322.0	H85522.0	H85822.0	H851222.0	R95055/64	R96055/64	R97055/64	H860N4	H861N3							
22.0						R95022.0	R96022.0	R97022.0									
7/8"						R9507/8	R9607/8	R9707/8									
22.5						R95022.5	R96022.5	R97022.5									
57/64"						R95057/64	R96057/64	R97057/64									
22.7						R95022.7	R96022.7	R97022.7									
23.0	H85123.0	H85323.0	H85523.0	H85823.0	H851223.0	R95023.0	R96023.0	R97023.0	H860N4	H861N3							
29/32"						R95029/32	R96029/32	R97029/32									
59/64"						R95059/64	R96059/64	R97059/64									
23.5						R95023.5	R96023.5	R97023.5									



BROCAS DE ALTO RENDIMIENTO CON CABEZA INTERCAMBIABLE

DC	H851 1.5xD	H853 3xD	H855 5xD	H858 8xD	H8512 12xD	R950	R960	R970	H860	H861
15/16	H85124.0 H85131/32	H85324.0 H85331/32	H85524.0 H85531/32	H85824.0	H851224.0	R95015/16	R96015/16	R97015/16	H860N4	H861N3
24.0						R95024.0	R96024.0	R97024.0		
61/64						R95061/64	R96061/64	R97061/64		
24.5						R95024.5	R96024.5	R97024.5		
31/32"						R95031/32	R96031/32	R97031/32		
25.0	H85125.0 H8511.1/64	H85325.0 H8531.1/64	H85525.0 H8551.1/64	H85825.0	H851225.0	R95025.0	R96025.0	R97025.0	H860N5	H861N4
63/64"						R95063/64	R96063/64	R97063/64		
1"						R9501	R9601	R9701		
25.5						R95025.5	R96025.5	R97025.5		
25.6						R95025.6	–	–		
25.65						R95025.65	R96025.65	R97025.65		
1.1/64"						R9501.1/64	R9601.1/64	R9701.1/64		
26.0						R95026.0	R96026.0	R97026.0		
1.1/32"						R9501.1/32	R9601.1/32	R9701.1/32		
26.5						R95026.5	R96026.5	R97026.5		
1.3/64	R9501.3/64	R9601.3/64	R9701.3/64							
1.1/16"	H85127.0 H8511.3/32	H85327.0 H8531.3/32	H85527.0 H8551.3/32	H85827.0	–	R9501.1/16	R9601.1/16	R9701.1/16	H860N6	H861N5
27.0						R95027.0	R96027.0	R97027.0		
1.5/64"						R9501.5/64	R9601.5/64	R9701.5/64		
27.5						R95027.5	R96027.5	R97027.5		
1.3/32"						R9501.3/32	R9601.3/32	R9701.3/32		
28.0	H85128.0 H8511.1/8	H85328.0 H8531.1/8	H85528.0 H8551.1/8	H85828.0	–	R95028.0	R96028.0	R97028.0	H860N7	H861N6
1.7/64"						R9501.7/64	R9601.7/64	R9701.7/64		
28.5						R95028.5	R96028.5	R97028.5		
1.1/8"						R9501.1/8	R9601.1/8	R9701.1/8		
1.9/64"	H85129.0 H8511.11/64	H85329.0 H8531.11/64	H85529.0 H8551.11/64	H85829.0	–	R9501.9/64	R9601.9/64	R9701.9/64	H860N8	H861N7
29.0						R95029.0	R96029.0	R97029.0		
1.5/32"						R9501.5/32	R9601.5/32	R9701.5/32		
29.5						R95029.5	R96029.5	R97029.5		
1.11/64"						R9501.11/64	R9601.11/64	R9701.11/64		
30.0	H85130.0 H8511.3/16	H85330.0 H8531.3/16	H85530.0 H8551.3/16	H85830.0	–	R95030.0	R96030.0	R97030.0	H860N9	H861N8
1.3/16"						R9501.3/16	R9601.3/16	R9701.3/16		
30.5						R95030.5	R96030.5	R97030.5		
1.7/32"	–	H85332.0	H85532.0	H85832.0	–	R9501.7/32	–	R9701.7/32	H860N10	H861N9
31.0						R95031.0	–	R97031.0		
1.1/4"						R9501.1/4	–	R9701.1/4		
32.0						R95032.0	–	R97032.0		
32.5	–	H85333.5	H85533.5	H85833.5	–	R95032.5	–	R97032.5	H860N11	H861N10
1.19/64"						R9501.19/64	–	R9701.19/64		
33.0						R95033.0	–	R97033.0		
33.5						R95033.5	–	R97033.5		
34.0	–	H85335.0	H85535.0	H85835.0	–	R95034.0	–	R97034.0	H860N12	H861N11
1.11/32"						R9501.11/32	–	R9701.11/32		
34.5						R95034.5	–	R97034.5		
1.3/8"						R9501.3/8	–	R9701.3/8		
35.0	–	H85336.5	H85536.5	H85836.5	–	R95035.0	–	R97035.0	H860N13	H861N12
36.0						R95036.0	–	R97036.0		
1.27/64"						R9501.27/64	–	R9701.27/64		
36.5						R95036.5	–	R97036.5		
37.0	–	H85338.0	H85538.0	H85838.0	–	R95037.0	–	R97037.0	H860N14	H861N13
1.15/32"						R9501.15/32	–	R9701.15/32		
37.5						R95037.5	–	R97037.5		
38.0						R95038.0	–	R97038.0		
1.1/2"	–	H85339.5	H85539.5	H85839.5	–	R9501.1/2	–	R9701.1/2	H860N15	H861N14
38.5						R95038.5	–	R97038.5		
1.17/32"						R9501.17/32	–	R9701.17/32		
39.0						R95039.0	–	R97039.0		
39.5	–	H85341.0	H85541.0	H85841.0	–	R95039.5	–	R97039.5	H860N16	H861N15
1.9/16"						R9501.9/16	–	R9701.9/16		
40.0						R95040.0	–	R97040.0		
41.0	–	–	–	–	–	R95041.0	–	R97041.0	–	–



BROCAS DE ALTO RENDIMIENTO CON CABEZA INTERCAMBIABLE

DC	H851 1.5×D	H853 3×D	H855 5×D	H858 8×D	H8512 12×D	R950	R960	R970	H860	H861
1.5/8"	–	H85342.5	H85542.5	H85842.5	–	R9501.5/8	–	R9701.5/8	H860N7	H861N6
42.0						R95042.0	–	R97042.0		

Accesorios

H860	H861	Cabeza Hydra DC			Tamaño de la llave/broca
		Métrica (mín.-máx.)	Fraccional (mín.-máx.)	Decimal (mín.-máx.)	
H860N1	H861N1	12.0 mm – 15.5 mm	15/32" – 39/64"	0.4688" – 0.6102"	8IP
H860N2	H861N2	15.6 mm – 18.5 mm	5/8" – 23/32"	0.6142" – 0.7283"	10IP
H860N3	H861N3	18.6 mm – 21.5 mm	47/64" – 27/32"	0.7323" – 0.8465"	15IP
H860N4	H861N3	22.0 mm – 24.5 mm	55/64" – 31/32"	0.8594" – 0.9688"	15IP
H860N5	H861N4	25.0 mm – 27.5 mm	63/64" – 1-3/32"	0.9843" – 1.0938"	20IP
H860N6	H861N5	28.0 mm – 33.5 mm	1-7/64" – 1-19/64"	1.1024" – 1.3189"	25IP
H860N7	H861N6	34.0 mm – 42.0 mm	1-11/32" – 1-5/8"	1.3386" – 1.6535"	4 mm



R950

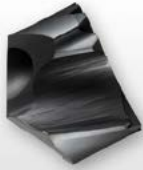

Cabeza HYDRA para Acero, con Recubrimiento Ti-phon

Cabeza intercambiable de precisión y altamente rentable para ofrecer un alto rendimiento en aceros y materiales más duros. La punta dividida de 140° favorece el autocentrado y reduce las fuerzas de corte. El recubrimiento Ti-phon evita el filo de aportación y mejora en gran medida el flujo de viruta, con una resistencia superior al desgaste y gran resistencia del filo.

HYDRA

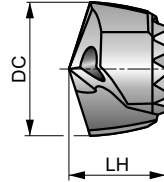

HM	DORMER	140°
Ti-phon	R	
DC h7		

H851	Aplicar valores de partida para la velocidad y el avance con un factor de corrección de 1,10
H853	Aplicar valores de partida para la velocidad y el avance con un factor de corrección de 1,00
H855	Aplicar valores de partida para la velocidad y el avance con un factor de corrección de 0,95
H858	Aplicar valores de partida para la velocidad y el avance con un factor de corrección de 0,90
H8512	Aplicar valores de partida para la velocidad y el avance con un factor de corrección de 0,80

Grupo de Material de la pieza adecuado y condiciones de velocidad de corte iniciales (m/min) y código de avance alfabético.

P1.1 █ 133 W	P1.2 █ 148 W	P1.3 █ 154 W	P2.1 █ 114 W	P2.2 █ 100 W	P2.3 █ 88 W	P3.1 █ 125 W	P3.2 █ 101 W	P3.3 █ 85 W	P4.1 █ 75 W	P4.2 █ 63 W	P4.3 █ 52 T	M2.3 █ 41 T	M4.2 █ 35 T
K2.1 █ 108 V	K2.2 █ 88 V	K2.3 █ 70 V	K3.1 █ 96 V	K3.2 █ 73 V	K3.3 █ 59 V	K4.1 █ 89 V	K4.2 █ 67 V	K4.3 █ 49 V	K4.4 █ 42 V	K4.5 █ 35 V	K5.1 █ 100 V	K5.2 █ 76 V	K5.3 █ 58 V

Producto	DC	DC	DC	LH
	(inch)	(mm)	(inch)	(mm)
R95015/32	15/32	11.91	0.4688	9.1
R95012.0	—	12.00	0.4724	9.1
R95012.1	—	12.10	0.4764	9.1
R95012.2	—	12.20	0.4803	9.1
R95031/64	31/64	12.30	0.4844	9.1
R95012.5	—	12.50	0.4921	9.4
R95012.6	—	12.60	0.4961	9.4
R9501/2	1/2	12.70	0.5000	9.4
R95012.8	—	12.80	0.5039	9.4
R95012.9	—	12.90	0.5079	9.4
R95013.0	—	13.00	0.5118	9.7
R95033/64	33/64	13.10	0.5156	9.7
R95013.2	—	13.20	0.5197	9.7
R95017/32	17/32	13.49	0.5313	9.7
R95013.5	—	13.50	0.5315	10.3
R95013.6	—	13.60	0.5354	10.3
R95013.7	—	13.70	0.5394	10.3
R95013.8	—	13.80	0.5433	10.3
R95035/64	35/64	13.89	0.5469	10.3
R95014.0	—	14.00	0.5512	10.3
R95014.1	—	14.10	0.5551	10.3
R95014.2	—	14.20	0.5591	10.3
R9509/16	9/16	14.29	0.5625	10.3
R95014.5	—	14.50	0.5709	10.3
R95014.6	—	14.60	0.5748	11.0
R95037/64	37/64	14.68	0.5781	11.0
R95014.7	—	14.70	0.5787	11.0
R95014.8	—	14.80	0.5827	11.0
R95015.0	—	15.00	0.5906	11.0
R95019/32	19/32	15.08	0.5938	11.0

Producto	DC	DC	DC	LH
	(inch)	(mm)	(inch)	(mm)
R95015.1	—	15.10	0.5945	11.0
R95015.2	—	15.20	0.5984	11.0
R95015.24	—	15.24	0.6000	11.0
R95039/64	39/64	15.48	0.6094	11.0
R95015.5	—	15.50	0.6102	11.0
R95015.6	—	15.60	0.6142	11.6
R95015.7	—	15.70	0.6181	11.6
R9505/8	5/8	15.88	0.6250	11.6
R95016.0	—	16.00	0.6299	11.6
R95016.08	—	16.08	0.6331	11.6
R95016.1	—	16.10	0.6339	11.6
R95016.2	—	16.20	0.6378	11.6
R95041/64	41/64	16.27	0.6406	11.6
R95016.3	—	16.30	0.6417	11.6
R95016.5	—	16.50	0.6496	11.6
R95016.6	—	16.60	0.6535	12.2
R95021/32	21/32	16.67	0.6563	12.2
R95016.7	—	16.70	0.6575	12.2
R95017.0	—	17.00	0.6693	12.2
R95043/64	43/64	17.07	0.6719	12.2
R95017.1	—	17.10	0.6732	12.2
R95017.2	—	17.20	0.6772	12.2
R95011/16	11/16	17.46	0.6875	12.2
R95017.5	—	17.50	0.6890	12.2
R95017.6	—	17.60	0.6929	12.9
R95017.7	—	17.70	0.6969	12.9
R95045/64	45/64	17.86	0.7031	12.9
R95018.0	—	18.00	0.7087	12.9
R95018.1	—	18.10	0.7126	12.9
R95018.2	—	18.20	0.7165	12.9



Producto	DC	DC	DC	LH
	(inch)	(mm)	(inch)	(mm)
R95023/32	23/32	18.26	0.7188	12.9
R95018.5	–	18.50	0.7283	12.9
R95018.6	–	18.60	0.7323	13.5
R95047/64	47/64	18.65	0.7344	13.5
R95018.7	–	18.70	0.7362	13.5
R95018.9	–	18.90	0.7441	13.5
R95019.0	–	19.00	0.7480	13.5
R9503/4	3/4	19.05	0.7500	13.5
R95019.1	–	19.10	0.7520	13.5
R95019.2	–	19.20	0.7559	13.5
R95019.25	–	19.25	0.7579	13.5
R95019.3	–	19.30	0.7598	13.5
R95019.35	–	19.35	0.7618	13.5
R95049/64	49/64	19.45	0.7656	13.5
R95019.5	–	19.50	0.7677	13.5
R95019.6	–	19.60	0.7717	14.1
R95019.7	–	19.70	0.7756	14.1
R95025/32	25/32	19.84	0.7813	14.1
R95020.0	–	20.00	0.7874	14.1
R95051/64	51/64	20.24	0.7969	14.1
R95020.5	–	20.50	0.8071	14.1
R95013/16	13/16	20.64	0.8125	14.8
R95021.0	–	21.00	0.8268	14.8
R95053/64	53/64	21.03	0.8281	14.8
R95027/32	27/32	21.43	0.8438	14.8
R95021.5	–	21.50	0.8465	14.8
R95055/64	55/64	21.83	0.8594	15.0
R95022.0	–	22.00	0.8661	15.0
R9507/8	7/8	22.22	0.8750	15.0
R95022.5	–	22.50	0.8858	15.0
R95057/64	57/64	22.62	0.8906	15.0
R95022.7	–	22.70	0.8937	15.0
R95023.0	–	23.00	0.9055	15.1
R95029/32	29/32	23.02	0.9063	15.1
R95059/64	59/64	23.42	0.9219	15.1
R95023.5	–	23.50	0.9252	15.1
R95015/16	15/16	23.81	0.9375	15.4
R95024.0	–	24.00	0.9449	15.4
R95061/64	61/64	24.21	0.9531	15.4
R95024.5	–	24.50	0.9646	15.4
R95031/32	31/32	24.61	0.9688	15.4
R95025.0	–	25.00	0.9844	15.8
R95063/64	63/64	25.00	0.9844	15.8
R9501	1"	25.40	1.0000	15.8
R95025.5	–	25.50	1.0039	15.8
R95025.6	–	25.60	1.0079	15.8
R95025.65	–	25.65	1.0098	15.8
R9501.1/64	1.1/64	25.80	1.0156	15.8
R95026.0	–	26.00	1.0236	16.4
R9501.1/32	1.1/32	26.19	1.0313	16.4

Producto	DC	DC	DC	LH
	(inch)	(mm)	(inch)	(mm)
R95026.5	–	26.50	1.0433	16.4
R9501.3/64	1.3/64	26.59	1.0469	16.4
R9501.1/16	1.1/16	26.99	1.0625	17.1
R95027.0	–	27.00	1.0630	17.1
R9501.5/64	1.5/64	27.38	1.0781	17.1
R95027.5	–	27.50	1.0827	17.1
R9501.3/32	1.3/32	27.78	1.0938	17.1
R95028.0	–	28.00	1.1024	17.7
R9501.7/64	1.7/64	28.18	1.1094	17.7
R95028.5	–	28.50	1.1220	17.7
R9501.1/8	1.1/8	28.58	1.1250	17.7
R9501.9/64	1.9/64	28.97	1.1406	18.3
R95029.0	–	29.00	1.1417	18.3
R9501.5/32	1.5/32	29.37	1.1563	18.3
R95029.5	–	29.50	1.1614	18.3
R9501.11/64	1.11/64	29.77	1.1719	18.3
R95030.0	–	30.00	1.1811	19.0
R9501.3/16	1.3/16	30.16	1.1875	19.0
R95030.5	–	30.50	1.2008	19.0
R9501.7/32	1.7/32	30.96	1.2188	21.0
R95031.0	–	31.00	1.2205	21.0
R9501.1/4	1.1/4	31.75	1.2500	21.0
R95032.0	–	32.00	1.2598	21.0
R95032.5	–	32.50	1.2795	21.0
R9501.19/64	1.19/64	32.94	1.2969	21.0
R95033.0	–	33.00	1.2992	21.0
R95033.5	–	33.50	1.3189	21.0
R95034.0	–	34.00	1.3386	23.0
R9501.11/32	1.11/32	34.13	1.3438	23.0
R95034.5	–	34.50	1.3583	23.0
R9501.3/8	1.3/8	34.93	1.3750	23.0
R95035.0	–	35.00	1.3780	23.0
R95036.0	–	36.00	1.4173	23.0
R9501.27/64	1.27/64	36.12	1.4219	23.0
R95036.5	–	36.50	1.4370	23.0
R95037.0	–	37.00	1.4567	25.0
R9501.15/32	1.15/32	37.31	1.4688	25.0
R95037.5	–	37.50	1.4764	25.0
R95038.0	–	38.00	1.4961	25.0
R9501.1/2	1.1/2	38.10	1.5000	25.0
R95038.5	–	38.50	1.5157	25.0
R9501.17/32	1.17/32	38.89	1.5313	25.0
R95039.0	–	39.00	1.5354	25.0
R95039.5	–	39.50	1.5551	25.0
R9501.9/16	1.9/16	39.69	1.5625	27.0
R95040.0	–	40.00	1.5748	27.0
R95041.0	–	41.00	1.6142	27.0
R9501.5/8	1.5/8	41.28	1.6250	27.0
R95042.0	–	42.00	1.6535	27.0



R960

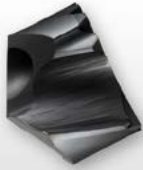

Cabeza HYDRA para Acero Inoxidable, con Recubrimiento Ti-phon

Cabeza intercambiable de precisión y altamente rentable para ofrecer un alto rendimiento en acero inoxidable. La punta dividida de 140° favorece el autocentrado y reduce las fuerzas de corte. El recubrimiento Ti-phon evita el filo de aportación y mejora en gran medida el flujo de viruta, con una resistencia superior al desgaste y gran resistencia del filo.

HYDRA

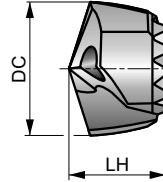

HM	DORMER	140°
Ti-phon	R	
DC h7		

H851	Aplicar valores de partida para la velocidad y el avance con un factor de corrección de 1,10
H853	Aplicar valores de partida para la velocidad y el avance con un factor de corrección de 1,00
H855	Aplicar valores de partida para la velocidad y el avance con un factor de corrección de 0,95
H858	Aplicar valores de partida para la velocidad y el avance con un factor de corrección de 0,90
H8512	Aplicar valores de partida para la velocidad y el avance con un factor de corrección de 0,80

Grupo de Material de la pieza adecuado y condiciones de velocidad de corte iniciales (m/min) y código de avance alfabético.

P1.1	P1.2	P1.3	P2.1	M1.1	M1.2	M2.1	M2.2	M2.3	M3.1	M3.2	M3.3	M4.1	M4.2
■ 133 W	■ 148 W	■ 154 W	■ 114 W	■ 82 V	■ 70 V	■ 73 V	■ 60 V	▣ 50 T	■ 58 T	■ 50 T	■ 45 T	■ 40 T	▣ 34 T
K1.1	K1.2	K1.3	K2.1	K2.2	K2.3	K3.1	K3.2	K3.3	K4.1	K4.2	K4.3	K4.4	K4.5
■ 120 V	■ 89 V	■ 67 V	▣ 108 V	▣ 88 V	▣ 70 V	▣ 96 V	▣ 73 V	▣ 59 V	▣ 89 V	▣ 67 V	▣ 49 V	▣ 42 V	▣ 35 V
K5.1	K5.2	K5.3	S1.1	S1.2	S1.3	S2.1	S2.2	S3.1	S3.2	S4.1	S4.2		
▣ 100 V	▣ 76 V	▣ 58 V	▣ 45 T	▣ 35 T	▣ 30 S	▣ 40 S	▣ 35 S	▣ 30 S	▣ 25 S	▣ 23 S	▣ 20 S		

Producto	DC	DC	DC	LH
	(inch)	(mm)	(inch)	(mm)
R96015/32	15/32	11.91	0.4688	9.1
R96012.0	—	12.00	0.4724	9.1
R96012.1	—	12.10	0.4764	9.1
R96012.2	—	12.20	0.4803	9.1
R96031/64	31/64	12.30	0.4844	9.1
R96012.5	—	12.50	0.4921	9.4
R96012.6	—	12.60	0.4961	9.4
R9601/2	1/2	12.70	0.5000	9.4
R96012.8	—	12.80	0.5039	9.4
R96012.9	—	12.90	0.5079	9.4
R96013.0	—	13.00	0.5118	9.7
R96033/64	33/64	13.10	0.5156	9.7
R96013.2	—	13.20	0.5197	9.7
R96017/32	17/32	13.49	0.5313	9.7
R96013.5	—	13.50	0.5315	10.3
R96013.6	—	13.60	0.5354	10.3
R96013.7	—	13.70	0.5394	10.3
R96013.8	—	13.80	0.5433	10.3
R96035/64	35/64	13.89	0.5469	10.3
R96014.0	—	14.00	0.5512	10.3
R96014.1	—	14.10	0.5551	10.3
R96014.2	—	14.20	0.5591	10.3
R9609/16	9/16	14.29	0.5625	10.3
R96014.5	—	14.50	0.5709	10.3
R96014.6	—	14.60	0.5748	11.0
R96037/64	37/64	14.68	0.5781	11.0
R96014.7	—	14.70	0.5787	11.0
R96014.8	—	14.80	0.5827	11.0

Producto	DC	DC	DC	LH
	(inch)	(mm)	(inch)	(mm)
R96015.0	—	15.00	0.5906	11.0
R96019/32	19/32	15.08	0.5938	11.0
R96015.1	—	15.10	0.5945	11.0
R96015.2	—	15.20	0.5984	11.0
R96015.24	—	15.24	0.6000	11.0
R96039/64	39/64	15.48	0.6094	11.0
R96015.5	—	15.50	0.6102	11.0
R96015.6	—	15.60	0.6142	11.6
R96015.7	—	15.70	0.6181	11.6
R9605/8	5/8	15.88	0.6250	11.6
R96016.0	—	16.00	0.6299	11.6
R96016.08	—	16.08	0.6331	11.6
R96016.1	—	16.10	0.6339	11.6
R96016.2	—	16.20	0.6378	11.6
R96041/64	41/64	16.27	0.6406	11.6
R96016.3	—	16.30	0.6417	11.6
R96016.5	—	16.50	0.6496	11.6
R96016.6	—	16.60	0.6535	12.2
R96021/32	21/32	16.67	0.6563	12.2
R96016.7	—	16.70	0.6575	12.2
R96017.0	—	17.00	0.6693	12.2
R96043/64	43/64	17.07	0.6719	12.2
R96017.1	—	17.10	0.6732	12.2
R96017.2	—	17.20	0.6772	12.2
R96011/16	11/16	17.46	0.6875	12.2
R96017.5	—	17.50	0.6890	12.2
R96017.6	—	17.60	0.6929	12.9
R96017.7	—	17.70	0.6969	12.9



Producto	DC	DC	DC	LH
	(inch)	(mm)	(inch)	(mm)
R96045/64	45/64	17.86	0.7031	12.9
R96018.0	–	18.00	0.7087	12.9
R96018.1	–	18.10	0.7126	12.9
R96018.2	–	18.20	0.7165	12.9
R96023/32	23/32	18.26	0.7188	12.9
R96018.5	–	18.50	0.7283	12.9
R96018.6	–	18.60	0.7323	13.5
R96047/64	47/64	18.65	0.7344	13.5
R96018.7	–	18.70	0.7362	13.5
R96018.9	–	18.90	0.7441	13.5
R96019.0	–	19.00	0.7480	13.5
R9603/4	3/4	19.05	0.7500	13.5
R96019.1	–	19.10	0.7520	13.5
R96019.2	–	19.20	0.7559	13.5
R96019.25	–	19.25	0.7579	13.5
R96019.3	–	19.30	0.7598	13.5
R96019.35	–	19.35	0.7618	13.5
R96049/64	49/64	19.45	0.7656	13.5
R96019.5	–	19.50	0.7677	13.5
R96019.6	–	19.60	0.7717	14.1
R96019.7	–	19.70	0.7756	14.1
R96025/32	25/32	19.84	0.7813	14.1
R96020.0	–	20.00	0.7874	14.1
R96051/64	51/64	20.24	0.7969	14.1
R96020.5	–	20.50	0.8071	14.1
R96013/16	13/16	20.64	0.8125	14.8
R96021.0	–	21.00	0.8268	14.8
R96053/64	53/64	21.03	0.8281	14.8
R96027/32	27/32	21.43	0.8438	14.8
R96021.5	–	21.50	0.8465	14.8
R96055/64	55/64	21.83	0.8594	15.0
R96022.0	–	22.00	0.8661	15.0
R9607/8	7/8	22.22	0.8750	15.0
R96022.5	–	22.50	0.8858	15.0
R96057/64	57/64	22.62	0.8906	15.0
R96022.7	–	22.70	0.8937	15.0

Producto	DC	DC	DC	LH
	(inch)	(mm)	(inch)	(mm)
R96023.0	–	23.00	0.9055	15.1
R96029/32	29/32	23.02	0.9063	15.1
R96059/64	59/64	23.42	0.9219	15.1
R96023.5	–	23.50	0.9252	15.1
R96015/16	15/16	23.81	0.9375	15.4
R96024.0	–	24.00	0.9449	15.4
R96061/64	61/64	24.21	0.9531	15.4
R96024.5	–	24.50	0.9646	15.4
R96031/32	31/32	24.61	0.9688	15.4
R96025.0	–	25.00	0.9844	15.8
R96063/64	63/64	25.00	0.9844	15.8
R9601	1"	25.40	1.0000	15.8
R96025.5	–	25.50	1.0039	15.8
R96025.65	–	25.65	1.0098	15.8
R9601.1/64	1.1/64	25.80	1.0156	15.8
R96026.0	–	26.00	1.0236	16.4
R9601.1/32	1.1/32	26.19	1.0313	16.4
R96026.5	–	26.50	1.0433	16.4
R9601.3/64	1.3/64	26.59	1.0469	16.4
R9601.1/16	1.1/16	26.99	1.0625	17.1
R96027.0	–	27.00	1.0630	17.1
R9601.5/64	1.5/64	27.38	1.0781	17.1
R96027.5	–	27.50	1.0827	17.1
R9601.3/32	1.3/32	27.78	1.0938	17.1
R96028.0	–	28.00	1.1024	17.7
R9601.7/64	1.7/64	28.18	1.1094	17.7
R96028.5	–	28.50	1.1220	17.7
R9601.1/8	1.1/8	28.58	1.1250	17.7
R9601.9/64	1.9/64	28.97	1.1406	18.3
R96029.0	–	29.00	1.1417	18.3
R9601.5/32	1.5/32	29.37	1.1563	18.3
R96029.5	–	29.50	1.1614	18.3
R9601.11/64	1.11/64	29.77	1.1719	18.3
R96030.0	–	30.00	1.1811	19.0
R9601.3/16	1.3/16	30.16	1.1875	19.0
R96030.5	–	30.50	1.2008	19.0



R970

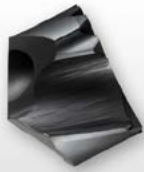

Cabeza HYDRA para Hierro Fundido, con Recubrimiento Ti-phon

Cabeza intercambiable de precisión y altamente rentable para ofrecer un alto rendimiento en fundición. La punta dividida de 140° favorece el auto-centrado y reduce las fuerzas de corte. El recubrimiento Ti-phon evita el filo de aportación y mejora en gran medida el flujo de viruta, con una resistencia superior al desgaste y gran resistencia del filo.

HYDRA

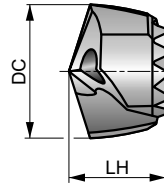

HM	DORMER	140°
Ti-phon	R	
DC h7		

H851	Aplicar valores de partida para la velocidad y el avance con un factor de corrección de 1,10
H853	Aplicar valores de partida para la velocidad y el avance con un factor de corrección de 1,00
H855	Aplicar valores de partida para la velocidad y el avance con un factor de corrección de 0,95
H858	Aplicar valores de partida para la velocidad y el avance con un factor de corrección de 0,90
H8512	Aplicar valores de partida para la velocidad y el avance con un factor de corrección de 0,80

Grupo de Material de la pieza adecuado y condiciones de velocidad de corte iniciales (m/min) y código de avance alfabético.

K1.1 ■ 120 V	K1.2 ■ 89 V	K1.3 ■ 67 V	K2.1 ■ 98 V	K2.2 ■ 80 V	K2.3 ■ 64 V	K3.1 ■ 97 V	K3.2 ■ 67 V	K3.3 ■ 54 V	K4.1 ■ 81 V	K4.2 ■ 61 V	K4.3 ■ 45 V	K4.4 ■ 38 V	K4.5 ■ 32 V
K5.1 ■ 91 V	K5.2 ■ 69 V	K5.3 ■ 53 V											

Producto	DC	DC	DC	LH
	(inch)	(mm)	(inch)	(mm)
R97015/32	15/32	11.91	0.4688	9.1
R97012.0	—	12.00	0.4724	9.1
R97012.1	—	12.10	0.4764	9.1
R97012.2	—	12.20	0.4803	9.1
R97031/64	31/64	12.30	0.4844	9.1
R97012.5	—	12.50	0.4921	9.4
R97012.6	—	12.60	0.4961	9.4
R9701/2	1/2	12.70	0.5000	9.4
R97012.8	—	12.80	0.5039	9.4
R97012.9	—	12.90	0.5079	9.4
R97013.0	—	13.00	0.5118	9.7
R97033/64	33/64	13.10	0.5156	9.7
R97013.2	—	13.20	0.5197	9.7
R97017/32	17/32	13.49	0.5313	9.7
R97013.5	—	13.50	0.5315	10.3
R97013.6	—	13.60	0.5354	10.3
R97013.7	—	13.70	0.5394	10.3
R97013.8	—	13.80	0.5433	10.3
R97035/64	35/64	13.89	0.5469	10.3
R97014.0	—	14.00	0.5512	10.3
R97014.1	—	14.10	0.5551	10.3
R97014.2	—	14.20	0.5591	10.3
R9709/16	9/16	14.29	0.5625	10.3
R97014.5	—	14.50	0.5709	10.3
R97014.6	—	14.60	0.5748	11.0
R97037/64	37/64	14.68	0.5781	11.0
R97014.7	—	14.70	0.5787	11.0
R97014.8	—	14.80	0.5827	11.0
R97015.0	—	15.00	0.5906	11.0
R97019/32	19/32	15.08	0.5938	11.0

Producto	DC	DC	DC	LH
	(inch)	(mm)	(inch)	(mm)
R97015.1	—	15.10	0.5945	11.0
R97015.2	—	15.20	0.5984	11.0
R97015.24	—	15.24	0.6000	11.0
R97039/64	39/64	15.48	0.6094	11.0
R97015.5	—	15.50	0.6102	11.0
R97015.6	—	15.60	0.6142	11.6
R97015.7	—	15.70	0.6181	11.6
R9705/8	5/8	15.88	0.6250	11.6
R97016.0	—	16.00	0.6299	11.6
R97016.08	—	16.08	0.6331	11.6
R97016.1	—	16.10	0.6339	11.6
R97016.2	—	16.20	0.6378	11.6
R97041/64	41/64	16.27	0.6406	11.6
R97016.3	—	16.30	0.6417	11.6
R97016.5	—	16.50	0.6496	11.6
R97016.6	—	16.60	0.6535	12.2
R97021/32	21/32	16.67	0.6563	12.2
R97016.7	—	16.70	0.6575	12.2
R97017.0	—	17.00	0.6693	12.2
R97043/64	43/64	17.07	0.6719	12.2
R97017.1	—	17.10	0.6732	12.2
R97017.2	—	17.20	0.6772	12.2
R97011/16	11/16	17.46	0.6875	12.2
R97017.5	—	17.50	0.6890	12.2
R97017.6	—	17.60	0.6929	12.9
R97017.7	—	17.70	0.6969	12.9
R97045/64	45/64	17.86	0.7031	12.9
R97018.0	—	18.00	0.7087	12.9
R97018.1	—	18.10	0.7126	12.9
R97018.2	—	18.20	0.7165	12.9



Producto	DC	DC	DC	LH
	(inch)	(mm)	(inch)	(mm)
R97023/32	23/32	18.26	0.7188	12.9
R97018.5	–	18.50	0.7283	12.9
R97018.6	–	18.60	0.7323	13.5
R97047/64	47/64	18.65	0.7344	13.5
R97018.7	–	18.70	0.7362	13.5
R97018.9	–	18.90	0.7441	13.5
R97019.0	–	19.00	0.7480	13.5
R9703/4	3/4	19.05	0.7500	13.5
R97019.1	–	19.10	0.7520	13.5
R97019.2	–	19.20	0.7559	13.5
R97019.25	–	19.25	0.7579	13.5
R97019.3	–	19.30	0.7598	13.5
R97019.35	–	19.35	0.7618	13.5
R97049/64	49/64	19.45	0.7656	13.5
R97019.5	–	19.50	0.7677	13.5
R97019.6	–	19.60	0.7717	14.1
R97019.7	–	19.70	0.7756	14.1
R97025/32	25/32	19.84	0.7813	14.1
R97020.0	–	20.00	0.7874	14.1
R97051/64	51/64	20.24	0.7969	14.1
R97020.5	–	20.50	0.8071	14.1
R97013/16	13/16	20.64	0.8125	14.8
R97021.0	–	21.00	0.8268	14.8
R97053/64	53/64	21.03	0.8281	14.8
R97027/32	27/32	21.43	0.8438	14.8
R97021.5	–	21.50	0.8465	14.8
R97055/64	55/64	21.83	0.8594	15.0
R97022.0	–	22.00	0.8661	15.0
R9707/8	7/8	22.22	0.8750	15.0
R97022.5	–	22.50	0.8858	15.0
R97057/64	57/64	22.62	0.8906	15.0
R97022.7	–	22.70	0.8937	15.0
R97023.0	–	23.00	0.9055	15.1
R97029/32	29/32	23.02	0.9063	15.1
R97059/64	59/64	23.42	0.9219	15.1
R97023.5	–	23.50	0.9252	15.1
R97015/16	15/16	23.81	0.9375	15.4
R97024.0	–	24.00	0.9449	15.4
R97061/64	61/64	24.21	0.9531	15.4
R97024.5	–	24.50	0.9646	15.4
R97031/32	31/32	24.61	0.9688	15.4
R97025.0	–	25.00	0.9844	15.8
R97063/64	63/64	25.00	0.9844	15.8
R9701	1"	25.40	1.0000	15.8
R97025.5	–	25.50	1.0039	15.8
R97025.65	–	25.65	1.0098	15.8
R9701.1/64	1.1/64	25.80	1.0156	15.8
R97026.0	–	26.00	1.0236	16.4
R9701.1/32	1.1/32	26.19	1.0313	16.4

Producto	DC	DC	DC	LH
	(inch)	(mm)	(inch)	(mm)
R97026.5	–	26.50	1.0433	16.4
R9701.3/64	1.3/64	26.59	1.0469	16.4
R9701.1/16	1.1/16	26.99	1.0625	17.1
R97027.0	–	27.00	1.0630	17.1
R9701.5/64	1.5/64	27.38	1.0781	17.1
R97027.5	–	27.50	1.0827	17.1
R9701.3/32	1.3/32	27.78	1.0938	17.1
R97028.0	–	28.00	1.1024	17.7
R9701.7/64	1.7/64	28.18	1.1094	17.7
R97028.5	–	28.50	1.1220	17.7
R9701.1/8	1.1/8	28.58	1.1250	17.7
R9701.9/64	1.9/64	28.97	1.1406	18.3
R97029.0	–	29.00	1.1417	18.3
R9701.5/32	1.5/32	29.37	1.1563	18.3
R97029.5	–	29.50	1.1614	18.3
R9701.11/64	1.11/64	29.77	1.1719	18.3
R97030.0	–	30.00	1.1811	19.0
R9701.3/16	1.3/16	30.16	1.1875	19.0
R97030.5	–	30.50	1.2008	19.0
R9701.7/32	1.7/32	30.96	1.2188	21.0
R97031.0	–	31.00	1.2205	21.0
R9701.1/4	1.1/4	31.75	1.2500	21.0
R97032.0	–	32.00	1.2598	21.0
R97032.5	–	32.50	1.2795	21.0
R9701.19/64	1.19/64	32.94	1.2969	21.0
R97033.0	–	33.00	1.2992	21.0
R97033.5	–	33.50	1.3189	21.0
R97034.0	–	34.00	1.3386	23.0
R9701.11/32	1.11/32	34.13	1.3438	23.0
R97034.5	–	34.50	1.3583	23.0
R9701.3/8	1.3/8	34.93	1.3750	23.0
R97035.0	–	35.00	1.3780	23.0
R97036.0	–	36.00	1.4173	23.0
R9701.27/64	1.27/64	36.12	1.4219	23.0
R97036.5	–	36.50	1.4370	23.0
R97037.0	–	37.00	1.4567	25.0
R9701.15/32	1.15/32	37.31	1.4688	25.0
R97037.5	–	37.50	1.4764	25.0
R97038.0	–	38.00	1.4961	25.0
R9701.1/2	1.1/2	38.10	1.5000	25.0
R97038.5	–	38.50	1.5157	25.0
R9701.17/32	1.17/32	38.89	1.5313	25.0
R97039.0	–	39.00	1.5354	25.0
R97039.5	–	39.50	1.5551	25.0
R9701.9/16	1.9/16	39.69	1.5625	27.0
R97040.0	–	40.00	1.5748	27.0
R97041.0	–	41.00	1.6142	27.0
R9701.5/8	1.5/8	41.28	1.6250	27.0
R97042.0	–	42.00	1.6535	27.0

NEW**H851****DORMER**

Cuerpo HYDRA 1.5XD, con Refrigeración Interna, Recubrimiento Niquelado Brillante

Se utiliza con cabezas HYDRA R950, R960 y R970. Se pueden utilizar varios diámetros de cabeza con el mismo cuerpo. Los agujeros de refrigerante alineados con las cabezas de corte ofrecen una refrigeración eficiente. El mango con brida evita que la broca se mueva en el soporte. La superficie brillante niquelada protege del óxido y la corrosión y mejora la evacuación de virutas.

HYDRA

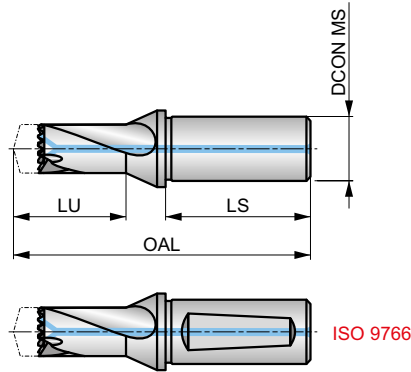

HSS	DORMER	1.5xD
Bright Ni	ISO 9766	R

Cuatro (4) tornillos y un (1) destornillador se incluyen en cada cuerpo de broca, DCON MS tolerancia h6.

Producto	DCONMS	DCON MS	LU	OAL	LS	ADINTMS
	(inch)	(mm)	(mm)	(mm)	(mm)	
H85131/64	5/8	15.88	25.50	88.5	47.6	Cylindrical
H8511/2	5/8	15.88	25.80	88.8	47.6	Cylindrical
H85117/32	5/8	15.88	30.90	93.9	47.6	Cylindrical
H85112.0	—	16.00	25.50	88.5	48.0	ISO 9766
H85112.5	—	16.00	25.80	88.8	48.0	ISO 9766
H85113.0	—	16.00	27.00	90.0	48.0	ISO 9766
H85114.0	—	16.00	30.90	93.9	48.0	ISO 9766
H8519/16	3/4	19.05	30.30	93.9	50.8	Cylindrical
H85139/64	3/4	19.05	32.30	97.3	50.8	Cylindrical
H85141/64	3/4	19.05	34.90	99.9	50.8	Cylindrical
H85111/16	3/4	19.05	36.40	101.4	50.8	Cylindrical
H85123/32	3/4	19.05	39.00	104.0	50.8	Cylindrical
H85115.0	—	20.00	32.30	97.3	50.0	ISO 9766
H85116.0	—	20.00	34.90	99.9	50.0	ISO 9766
H85117.0	—	20.00	36.40	101.4	50.0	ISO 9766
H85118.0	—	20.00	39.00	104.0	50.0	ISO 9766
H85119.0	—	25.00	40.40	111.4	56.0	ISO 9766
H85120.0	—	25.00	43.00	114.0	56.0	ISO 9766
H85121.0	—	25.00	44.50	115.5	56.0	ISO 9766
H85122.0	—	25.00	46.10	117.1	56.0	ISO 9766
H85123.0	—	25.00	47.00	118.0	56.0	ISO 9766
H85149/64	1"	25.40	40.40	111.4	57.1	Cylindrical
H85151/64	1"	25.40	43.00	114.0	57.1	Cylindrical
H85127/32	1"	25.40	44.50	115.5	57.1	Cylindrical
H85157/64	1"	25.40	46.10	117.1	57.1	Cylindrical
H85159/64	1"	25.40	47.00	118.0	57.1	Cylindrical
H85131/32	1"	25.40	49.30	124.3	57.1	Cylindrical
H8511.1/64	1.1/4	31.75	49.70	124.7	60.3	Cylindrical
H8511.3/64	1.1/4	31.75	52.30	127.3	60.3	Cylindrical
H8511.3/32	1.1/4	31.75	52.80	127.8	60.3	Cylindrical
H8511.1/8	1.1/4	31.75	54.40	129.4	60.3	Cylindrical
H8511.11/64	1.1/4	31.75	55.80	130.8	60.3	Cylindrical
H8511.3/16	1.1/4	31.75	58.40	133.4	60.3	Cylindrical
H85124.0	—	32.00	49.30	124.3	60.0	ISO 9766



Producto	DCONMS	DCON MS	LU	OAL	LS	ADINTMS
	(inch)	(mm)	(mm)	(mm)	(mm)	
H85125.0	–	32.00	49.70	124.7	60.0	ISO 9766
H85126.0	–	32.00	52.30	127.3	60.0	ISO 9766
H85127.0	–	32.00	52.80	127.8	60.0	ISO 9766
H85128.0	–	32.00	54.40	129.4	60.0	ISO 9766
H85129.0	–	32.00	55.80	130.8	60.0	ISO 9766
H85130.0	–	32.00	58.40	133.4	60.0	ISO 9766



H853



Cuerpo HYDRA 3XD, con Refrigeración Interna, Recubrimiento Niquelado Brillante

Se utiliza con cabezas HYDRA R950, R960 y R970. Se pueden utilizar varios diámetros de cabeza con el mismo cuerpo. Los agujeros de refrigerante alineados con las cabezas de corte ofrecen una refrigeración eficiente. La superficie brillante niquelada protege del óxido y la corrosión y mejora la evacuación de virutas.

HYDRA

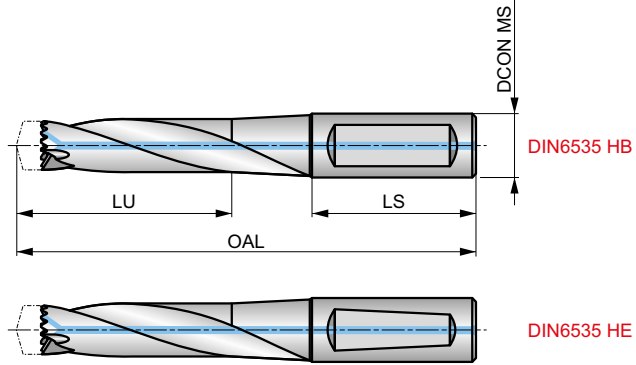

HSS	DORMER	3xD
Bright Ni	DIN 6535HB DIN 6535HE	R

Cuatro (4) tornillos y un (1) destornillador se incluyen en cada cuerpo de broca, DCON MS tolerancia h6.

Producto	DCONMS	DCON MS	LU	OAL	LS	ADINTMS
	(inch)	(mm)	(mm)	(mm)	(mm)	
H85312.0	—	16.00	44.00	105.0	48.0	DIN6535HE
H85331/64	5/8	15.88	44.00	105.0	48.0	DIN6535HB
H85312.5	—	16.00	44.00	105.0	48.0	DIN6535HE
H8531/2	5/8	15.88	44.00	105.0	48.0	DIN6535HB
H85313.0	—	16.00	47.00	110.0	48.0	DIN6535HE
H85317/32	5/8	15.88	47.00	110.0	48.0	DIN6535HB
H85314.0	—	16.00	52.50	116.5	48.0	DIN6535HE
H8539/16	3/4	19.05	52.50	116.5	48.0	DIN6535HB
H85315.0	—	20.00	55.50	126.5	50.0	DIN6535HE
H85339/64	3/4	19.05	55.50	126.5	50.0	DIN6535HB
H85316.0	—	20.00	59.50	131.5	50.0	DIN6535HE
H85341/64	3/4	19.05	59.50	131.5	50.0	DIN6535HB
H85317.0	—	20.00	62.50	136.5	50.0	DIN6535HE
H85311/16	3/4	19.05	62.50	136.5	50.0	DIN6535HB
H85318.0	—	20.00	66.50	141.5	50.0	DIN6535HE
H85323/32	3/4	19.05	66.50	141.5	50.0	DIN6535HB
H85319.0	—	25.00	69.50	156.5	56.0	DIN6535HE
H85349/64	1"	25.40	69.50	156.5	56.0	DIN6535HB
H85320.0	—	25.00	73.50	156.5	56.0	DIN6535HE
H85351/64	1"	25.40	73.50	156.5	56.0	DIN6535HB
H85321.0	—	25.00	76.50	156.5	56.0	DIN6535HE
H85327/32	1"	25.40	76.50	156.5	56.0	DIN6535HB
H85322.0	—	25.00	80.10	161.5	56.0	DIN6535HE
H85357/64	1"	25.40	80.10	161.5	56.0	DIN6535HB
H85323.0	—	25.00	82.50	160.5	56.0	DIN6535HE
H85359/64	1"	25.40	82.50	160.5	56.0	DIN6535HB
H85324.0	—	32.00	86.20	170.2	60.0	DIN6535HE
H85331/32	1"	25.40	86.20	170.2	60.0	DIN6535HB
H85325.0	—	32.00	88.00	170.0	60.0	DIN6535HE
H8531.1/64	1.1/4	31.75	88.00	170.0	60.0	DIN6535HB
H85326.0	—	32.00	92.00	175.0	60.0	DIN6535HE
H8531.3/64	1.1/4	31.75	92.00	175.0	60.0	DIN6535HB
H85327.0	—	32.00	94.00	175.0	60.0	DIN6535HE
H8531.3/32	1.1/4	31.75	94.00	175.0	60.0	DIN6535HB



Producto	DCONMS	DCON MS	LU	OAL	LS	ADINTMS
	(inch)	(mm)	(mm)	(mm)	(mm)	
H85328.0	–	32.00	97.00	180.0	60.0	DIN6535HE
H8531.1/8	1.1/4	31.75	97.00	180.0	60.0	DIN6535HB
H85329.0	–	32.00	100.00	185.0	60.0	DIN6535HE
H8531.11/64	1.1/4	31.75	100.00	185.0	60.0	DIN6535HB
H85330.0	–	32.00	104.00	185.0	60.0	DIN6535HE
H8531.3/16	1.1/4	31.75	104.00	185.0	60.0	DIN6535HB
H85332.0	–	32.00	111.50	196.5	60.0	DIN6535HE
H85333.5	–	32.00	116.50	201.5	60.0	DIN6535HE
H85335.0	–	40.00	121.50	216.5	70.0	DIN6535HB
H85336.5	–	40.00	125.50	221.5	70.0	DIN6535HB
H85338.0	–	40.00	131.50	226.5	70.0	DIN6535HB
H85339.5	–	40.00	136.50	231.5	70.0	DIN6535HB
H85341.0	–	40.00	146.50	246.5	70.0	DIN6535HB
H85342.5	–	40.00	151.60	251.6	70.0	DIN6535HB



H855



Cuerpo HYDRA 5XD, con Refrigeración Interna, Recubrimiento Niquelado Brillante

Se utiliza con cabezas HYDRA R950, R960 y R970. Se pueden utilizar varios diámetros de cabeza con el mismo cuerpo. Los agujeros de refrigerante alineados con las cabezas de corte ofrecen una refrigeración eficiente. La superficie brillante niquelada protege del óxido y la corrosión y mejora la evacuación de virutas.

HYDRA

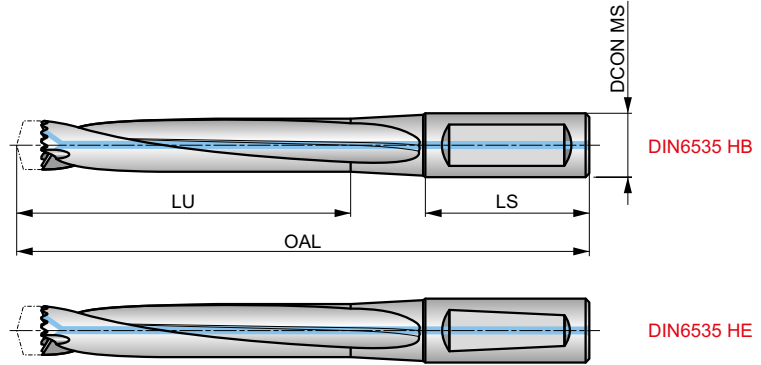

HSS	DORMER	5xD
Bright Ni	DIN 6535HB DIN 6535HE	R

Cuatro (4) tornillos y un (1) destornillador se incluyen en cada cuerpo de broca, DCON MS tolerancia h6.

Producto	DCONMS	DCON MS	LU	OAL	LS	ADINTMS
	(inch)	(mm)	(mm)	(mm)	(mm)	
H85512.0	—	16.00	69.00	130.0	48.0	DIN6535HE
H85531/64	5/8	15.88	69.00	130.0	48.0	DIN6535HB
H85512.5	—	16.00	69.00	130.0	48.0	DIN6535HE
H8551/2	5/8	15.88	69.00	130.0	48.0	DIN6535HB
H85513.0	—	16.00	74.00	140.0	48.0	DIN6535HE
H85517/32	5/8	15.88	74.00	140.0	48.0	DIN6535HB
H85514.0	—	16.00	81.50	146.5	48.0	DIN6535HE
H8559/16	3/4	19.05	81.50	146.5	48.0	DIN6535HB
H85515.0	—	20.00	86.50	156.5	50.0	DIN6535HE
H85539/64	3/4	19.05	86.50	156.5	50.0	DIN6535HB
H85516.0	—	20.00	92.50	166.5	50.0	DIN6535HE
H85541/64	3/4	19.05	92.50	166.5	50.0	DIN6535HB
H85517.0	—	20.00	97.50	171.5	50.0	DIN6535HE
H85511/16	3/4	19.05	97.50	171.5	50.0	DIN6535HB
H85518.0	—	20.00	103.50	176.5	50.0	DIN6535HE
H85523/32	3/4	19.05	103.50	176.5	50.0	DIN6535HB
H85519.0	—	25.00	108.50	191.5	56.0	DIN6535HE
H85549/64	1"	25.40	108.50	191.5	56.0	DIN6535HB
H85520.0	—	25.00	114.50	196.5	56.0	DIN6535HE
H85551/64	1"	25.40	114.50	196.5	56.0	DIN6535HB
H85521.0	—	25.00	119.50	196.5	56.0	DIN6535HE
H85527/32	1"	25.40	119.50	196.5	56.0	DIN6535HB
H85522.0	—	25.00	125.10	201.1	56.0	DIN6535HE
H85557/64	1"	25.40	125.10	201.1	56.0	DIN6535HB
H85523.0	—	25.00	129.50	210.5	56.0	DIN6535HE
H85559/64	1"	25.40	129.50	210.5	56.0	DIN6535HB
H85524.0	—	32.00	135.20	220.2	60.0	DIN6535HE
H85531/32	1"	25.40	135.20	220.2	60.0	DIN6535HB
H85525.0	—	32.00	140.00	225.0	60.0	DIN6535HE
H8551.1/64	1.1/4	31.75	140.00	225.0	60.0	DIN6535HB
H85526.0	—	32.00	146.00	230.0	60.0	DIN6535HE
H8551.3/64	1.1/4	31.75	146.00	230.0	60.0	DIN6535HB
H85527.0	—	32.00	151.00	235.0	60.0	DIN6535HE
H8551.3/32	1.1/4	31.75	151.00	235.0	60.0	DIN6535HB



Producto	DCONMS	DCON MS	LU	OAL	LS	ADINTMS
	(inch)	(mm)	(mm)	(mm)	(mm)	
H85528.0	–	32.00	157.00	240.0	60.0	DIN6535HE
H8551.1/8	1.1/4	31.75	157.00	240.0	60.0	DIN6535HB
H85529.0	–	32.00	162.00	245.0	60.0	DIN6535HE
H8551.11/64	1.1/4	31.75	162.00	245.0	60.0	DIN6535HB
H85530.0	–	32.00	167.00	255.0	60.0	DIN6535HE
H8551.3/16	1.1/4	31.75	167.00	255.0	60.0	DIN6535HB
H85532.0	–	32.00	176.50	261.5	60.0	DIN6535HE
H85533.5	–	32.00	186.50	271.5	60.0	DIN6535HE
H85535.0	–	40.00	196.50	291.5	70.0	DIN6535HB
H85536.5	–	40.00	201.50	296.5	70.0	DIN6535HB
H85538.0	–	40.00	211.50	306.5	70.0	DIN6535HB
H85539.5	–	40.00	221.50	316.5	70.0	DIN6535HB
H85541.0	–	40.00	226.50	325.6	70.0	DIN6535HB
H85542.5	–	40.00	236.50	336.5	70.0	DIN6535HB



H858



Cuerpo HYDRA 8XD, con Refrigeración Interna, Recubrimiento Niquelado Brillante

Se utiliza con cabezas HYDRA R950, R960 y R970. Se pueden utilizar varios diámetros de cabeza con el mismo cuerpo. Los agujeros de refrigerante alineados con las cabezas de corte ofrecen una refrigeración eficiente. La superficie brillante niquelada protege del óxido y la corrosión y mejora la evacuación de virutas.

HYDRA

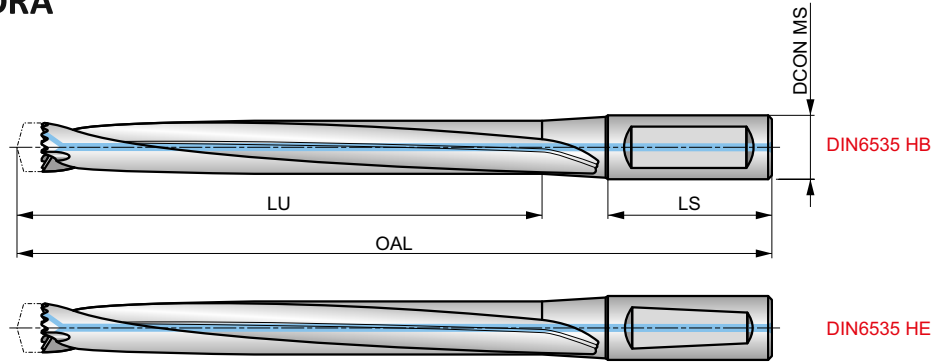

HSS	DORMER	8xD
Bright Ni	DIN 6535HB DIN 6535HE	R

Cuatro (4) tornillos y un (1) destornillador se incluyen en cada cuerpo de broca, DCON MS tolerancia h6.

Producto	DCON MS (mm)	LU (mm)	OAL (mm)	LS (mm)	ADINTMS
H85814.0	16.00	124.50	191.5	48.0	DIN6535HE
H85815.0	20.00	133.50	201.5	50.0	DIN6535HE
H85816.0	20.00	141.50	211.5	50.0	DIN6535HE
H85817.0	20.00	150.50	221.5	50.0	DIN6535HE
H85818.0	20.00	158.50	226.5	50.0	DIN6535HE
H85819.0	25.00	167.50	251.5	56.0	DIN6535HE
H85820.0	25.00	175.50	264.5	56.0	DIN6535HE
H85821.0	25.00	184.50	266.5	56.0	DIN6535HE
H85822.0	25.00	192.10	271.1	56.0	DIN6535HE
H85823.0	25.00	200.50	280.5	56.0	DIN6535HE
H85824.0	32.00	208.20	295.2	60.0	DIN6535HE
H85825.0	32.00	217.00	300.0	60.0	DIN6535HE
H85826.0	32.00	225.00	310.0	60.0	DIN6535HE
H85827.0	32.00	234.00	320.0	60.0	DIN6535HE
H85828.0	32.00	242.00	325.0	60.0	DIN6535HE
H85829.0	32.00	251.00	335.0	60.0	DIN6535HE
H85830.0	32.00	259.00	345.0	60.0	DIN6535HE
H85832.0	32.00	271.50	356.5	60.0	DIN6535HE
H85833.5	32.00	286.50	371.5	60.0	DIN6535HE
H85835.0	40.00	301.50	396.5	70.0	DIN6535HB
H85836.5	40.00	311.50	406.5	70.0	DIN6535HB
H85838.0	40.00	326.50	421.5	70.0	DIN6535HB
H85839.5	40.00	336.50	431.5	70.0	DIN6535HB
H85841.0	40.00	351.50	451.5	70.0	DIN6535HB
H85842.5	40.00	361.50	461.5	70.0	DIN6535HB



NEW

H8512

DORMER



Cuerpo HYDRA 12XD, con Refrigeración Interna, Recubrimiento Niquelado Brillante

Se utiliza con cabezas HYDRA R950, R960 y R970. Se pueden utilizar varios diámetros de cabeza con el mismo cuerpo. Los agujeros de refrigerante alineados con las cabezas de corte ofrecen una refrigeración eficiente. El mango con brida evita que la broca se mueva en el soporte. La superficie brillante niquelada protege del óxido y la corrosión y mejora la evacuación de virutas.

HYDRA

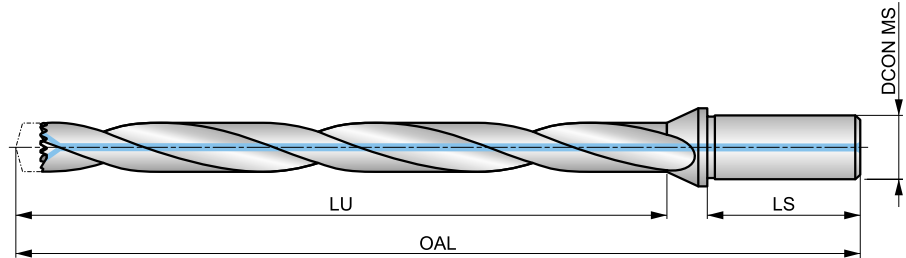

HSS	DORMER	12xD
Bright Ni		R

Cuatro (4) tornillos y un (1) destornillador se incluyen en cada cuerpo de broca, DCON MS tolerancia h6.

Producto	DCON MS (mm)	LU (mm)	OAL (mm)	LS (mm)
H851214.0	16.00	168.00	236.0	48.0
H851215.0	20.00	180.00	250.3	50.0
H851216.0	20.00	192.00	262.6	50.0
H851217.0	20.00	204.00	275.0	50.0
H851218.0	20.00	216.00	287.2	50.0
H851219.0	25.00	228.00	305.6	56.0
H851220.0	25.00	240.00	317.8	56.0
H851221.0	25.00	252.00	330.1	56.0
H851222.0	25.00	264.00	343.0	56.0
H851223.0	25.00	276.00	354.8	56.0
H851224.0	32.00	288.00	371.7	60.0
H851225.0	32.00	300.00	383.8	60.0



H860



Tornillos para HYDRA

Tornillos de repuesto para sujetar firmemente las cabezas HYDRA en su lugar.



HYDRA

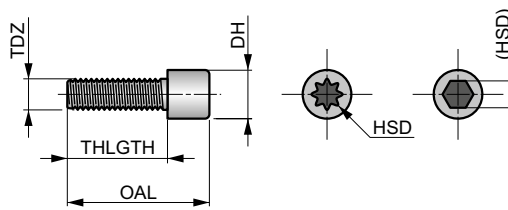

Producto	Nr.	TDZ	OAL	THLGTH	DH	HSD
			(mm)	(mm)	(mm)	
H860N1	1	M2.2	7.5	5.70	3.5	8IP
H860N2	2	M2.5	9.0	7.00	4.1	10IP
H860N3	3	M3.0	10.5	8.00	4.9	15IP
H860N4	4	M3.5	11.5	8.80	5.5	15IP
H860N5	5	M4.0	12.5	9.50	6.0	20IP
H860N6	6	M4.5	14.3	10.80	6.8	25IP
H860N7	7	M5.0	20.0	15.00	8.5	4



H861



Destornillador para HYDRA

Destornilladores para apretar los tornillos HYDRA.

HYDRA

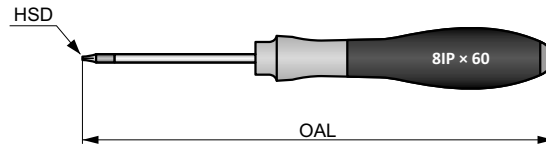

Producto	Nr.	HSD	OAL
			(mm)
H861N1	N1	8IP	164.0
H861N2	N2	10IP	191.0
H861N3	N3	15IP	191.0
H861N4	N4	20IP	218.0
H861N5	N5	25IP	218.0
H861N6	N6	4	186.0



FACTORES DE CORRECCIÓN DE LAS CONDICIONES DE CORTE (EN FUNCIÓN DE LAS LONGITUDES DE CUERPO HYDRA)

H851	Aplicar valores de partida para la velocidad y el avance con un factor de corrección de 1,10
H853	Aplicar valores de partida para la velocidad y el avance con un factor de corrección de 1,00
H855	Aplicar valores de partida para la velocidad y el avance con un factor de corrección de 0,95
H858	Aplicar valores de partida para la velocidad y el avance con un factor de corrección de 0,90
H8512	Aplicar valores de partida para la velocidad y el avance con un factor de corrección de 0,80



**BROCAS DE PLAQUITA
INTERCAMBIABLE INFORMACIÓN TÉCNICA**



HYDRA: INFORMACIÓN TÉCNICA

Tabla de pares

H860	H861	Ø cabeza Hydra gama métrica	Ø cabeza Hydra gama fraccional	Ø cabeza Hydra gama de tamanos decimales (min./max.)	Valores de par Nm (sistema métrico)	Valores de par in/lbs (sistema imperial)
H860N1	H861N1	12.0 mm – 15.5 mm	15/32" – 39/64"	0.4688" – 0.6102"	0.75 – 0.99	6.6 – 8.8
H860N2	H861N2	15.6 mm – 18.5 mm	5/8" – 23/32"	0.6142" – 0.7283"	0.93 – 1.24	8.2 – 11.0
H860N3	H861N3	18.6 mm – 21.5 mm	47/64" – 27/32"	0.7323" – 0.8465"	1.84 – 2.44	16.3 – 21.6
H860N4	H861N3	22.0 mm – 24.5 mm	55/64" – 31/32"	0.8594" – 0.9688"	2.73 – 3.72	24.2 – 32.9
H860N5	H861N4	25.0 mm – 27.5 mm	63/64" – 1-3/32"	0.9843" – 1.0938"	4.14 – 5.52	36.6 – 48.8
H860N6	H861N5	28.0 mm – 33.5 mm	1-7/64" – 1-19/64"	1.1024" – 1.3189"	4.97 – 6.63	44.0 – 58.7
H860N7	H861N6	34.0 mm – 42.0 mm	1-11/32" – 1-5/8"	1.3386" – 1.6535"	7.2	63.7

Datos del tornillo y el destornillador

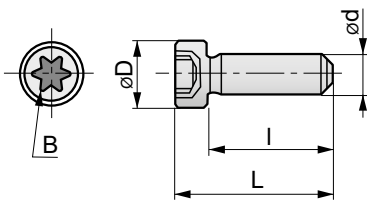

Código e	d	Paso	L (mm)	I (mm)	D (mm)	B
H860N1	M2.2	0.45	7.5	5.7	3.5	8IP
H860N2	M2.5	0.45	9.0	7.0	4.1	10IP
H860N3	M3.0	0.50	10.5	8.0	4.9	15IP
H860N4	M3.5	0.60	11.5	8.8	5.5	15IP
H860N5	M4.0	0.70	12.5	9.5	6.0	20IP
H860N6	M4.5	0.75	14.3	10.8	6.8	25IP

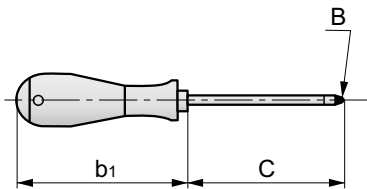

Código e	B	C	b ₁
H861N1	8IP	60	104
H861N2	10IP	80	111
H861N3	15IP	80	111
H861N4	20IP	100	118
H861N5	25IP	100	118

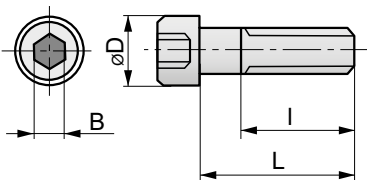

Código e	d	Paso	L (mm)	I (mm)	D (mm)	B
H860N7	M5.0	0.8	15	full	8.5	4

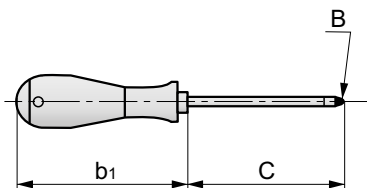

Código e	B	C	b ₁
H861N6	4	75	111



HYDRA: INFORMACIÓN TÉCNICA

Uso del programa especial para el taladrado 8xD y 12xD

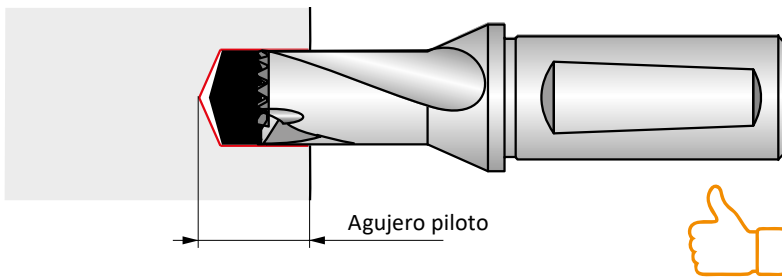

Taladre un agujero piloto (de 1,5xD a 3xD de profundidad) con el mismo diámetro del cabezal HYDRA (si es necesario, compruebe la excentricidad de la broca máx. +/- 0,05 mm).

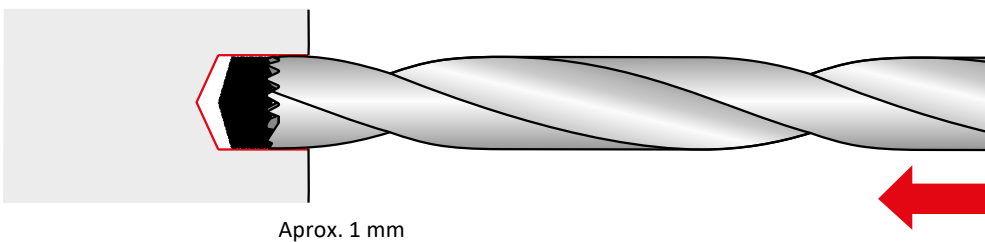

Introduzca el agujero piloto con el cuerpo 8xD o 12xD a un máximo de 500 rpm, hasta aproximadamente 1 mm, por encima de la profundidad del agujero piloto pretaladrado.

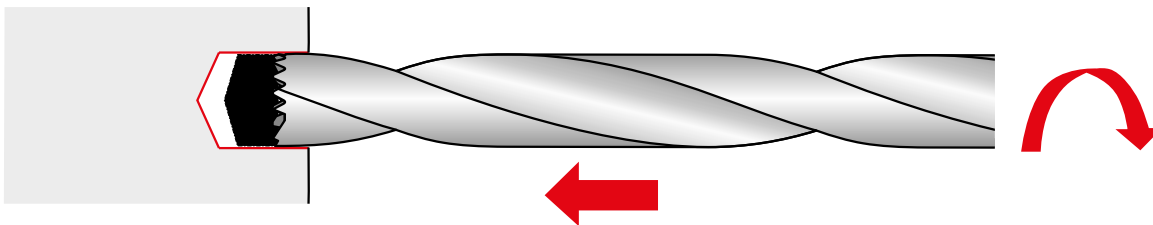

Inicie el flujo de refrigerante y aumente la velocidad de rotación hasta alcanzar el valor de RPM recomendado.

Nota: Aplique un tiempo de permanencia corto y no inicie la alimentación antes de alcanzar el valor de RPM recomendado.

Taladre sin llegar hasta la profundidad requerida.

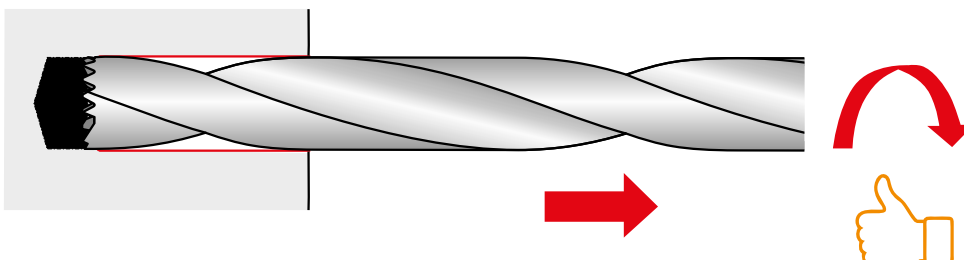

Cuando se alcance la profundidad deseada, retraiga la broca aproximadamente de 0,1 mm a 0,5 mm y reduzca a 500 rpm; a continuación, retraiga la broca por completo con el avance normal. **Nota: Retraer la broca con una velocidad de husillo más elevada puede provocar un daño en el hombro a causa del rebasamiento o dañar la superficie del agujero y afectar a la tolerancia.**



Consejos para taladrar con la broca Hydra

Refrigerantes

Para lograr una evacuación de viruta y un rendimiento de la herramienta máximos se recomienda utilizar refrigerante. Se recomienda una concentración de refrigerante en emulsión del 6 al 8 % para la mayoría de las aplicaciones, con una presión de refrigerante de 20 bar (290 PSI) o superior. Para los aceros de alta resistencia, los aceros inoxidable y las aplicaciones de perforación más duras, utilice una concentración más alta, del 10 al 12 %. En estas aplicaciones, especialmente en aceros inoxidable, se recomienda utilizar la máxima presión de refrigerante en la máquina. Las brocas Hydra con lubricación interior proporcionan una mayor resistencia del alma y reducen el calor en los filos de corte para aumentar la productividad y prolongar la vida útil de la herramienta.

Portaherramientas

Utilice siempre portaherramientas y pinzas que garanticen una buena

concentricidad entre la broca y el husillo de la máquina. Utilice un tope positivo para evitar que la herramienta retroceda en el portaherramientas. Se debe comprobar y mantener con precisión la desviación radial en el conjunto de la herramienta.

Pieza

Una pieza segura y rígida minimizará la desviación y permitirá una mayor precisión y una posición real del agujero.

Avances

Es importante no aplicar velocidades de avance muy bajas en la broca, ya que esto provocaría su parada momentánea y que se quedara sin filo. Esto se da especialmente en materiales con endurecimiento por deformación en frío. Las velocidades de avance deben ser lo suficientemente elevadas para permitir la correcta formación de virutas.

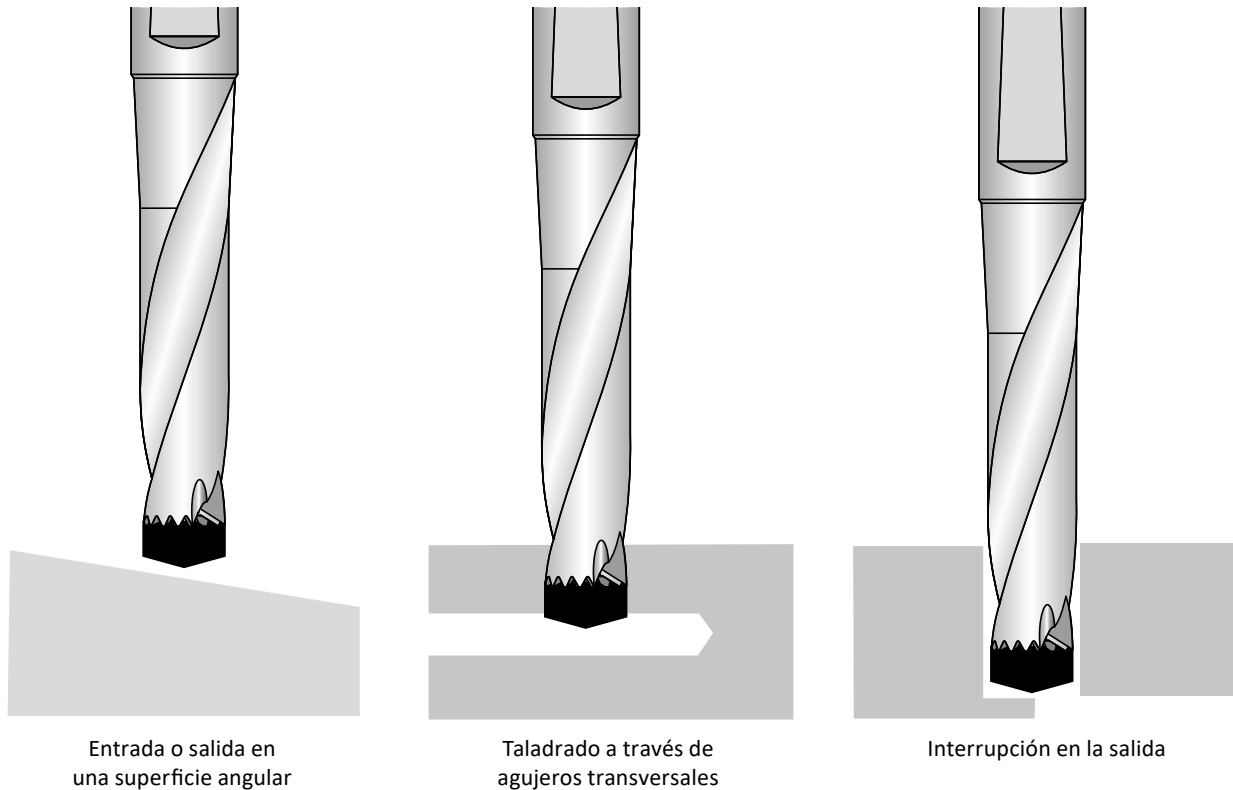

En estos casos de taladrado suele ser recomendable reducir la velocidad de avance a 1/3 (33 %). Taladrado NO es recomendable en un ángulo de entrada de más de 10°; en dicho caso, la superficie debe ser fresada plana primero.



INFORMACIÓN TÉCNICA GENERAL

	Calidad	Dureza (HV10)	C %	W %	Mo %	Cr %	V %	Co %	Material de la herramienta
HSS	M2	810 – 850	0.9	6.4	5.0	4.2	1.8	–	HSS

Propiedades	Materiales HSS	Materiales de metal duro	K10/30F (se suele utilizar para herramientas duras)
Dureza (HV30)	800 – 950	1300 – 1800	1600
Densidad (g/cm³)	8.0 – 9.0	7.2 – 15	14.45
Fuerza de compresión (N/mm²)	3000 – 4000	3000 – 8000	6250
Resistencia a la flexión, (flexión) (N/mm²)	2500 – 4000	1000 – 4700	4300
Resistencia al calor (°C)	550	1000	900
Módulo eléctrico (KN/mm²)	260 – 300	460 – 630	580
Tamaño de grano (µm)	–	0.2 – 10	0.8

La combinación de la partícula dura (WC) y el metal aglutinante (Co) provoca los siguientes cambios en las características.

Característica	Un mayor contenido de WC	Un mayor contenido de Co
Dureza	Mayor dureza	Menor dureza
Fuerza de compresión (CS)	Mayor CS	Menor CS
Resistencia a la flexión (BS)	Menor BS	Mayor BS

El tamaño de grano también influye en las propiedades del material. Los tamaños de grano pequeños se traducen en una mayor dureza y los granos gruesos, en una mayor tenacidad.



INFORMACIÓN TÉCNICA GENERAL

Tolerancias estándar de la industria para ejes y agujeros

Los valores de tolerancia se indican en micras (μm)

Fórmula para las micras ...1 $\mu\text{m} = 0,001 \text{ mm} / 0,000039''$

Tolerancia	Diámetro (mm)							
	> 1 ≤ 3	> 3 ≤ 6	> 6 ≤ 10	> 10 ≤ 18	> 18 ≤ 30	> 30 ≤ 50	> 50 ≤ 80	> 80 ≤ 120
	Diámetro (pulgadas)							
	> 0.039" ≤ 0.118"	> 0.118" ≤ 0.236"	> 0.236" ≤ 0.394"	> 0.394" ≤ 0.709"	> 0.709" ≤ 1.181"	> 1.181" ≤ 1.968"	> 1.968" ≤ 3.149"	> 3.149" ≤ 4.724"
Valores de tolerancia (μm)								
e8	-14 / -28	-20 / -38	-25 / -47	-32 / -59	-40 / -73	-50 / -89	-60 / -106	-72 / -126
f6	-6 / -12	-10 / -18	-13 / -22	-16 / -27	-20 / -33	-25 / -41	-30 / -49	-36 / -58
f7	-6 / -16	-10 / -22	-13 / -28	-16 / -34	-20 / -41	-25 / -50	-30 / -60	-36 / -71
h6	0 / -6	0 / -8	0 / -9	0 / -11	0 / -13	0 / -16	0 / -19	0 / -22
h7	0 / -10	0 / -12	0 / -15	0 / -18	0 / -21	0 / -25	0 / -30	0 / -35
h8	0 / -14	0 / -18	0 / -22	0 / -27	0 / -33	0 / -39	0 / -46	0 / -54
h9	0 / -25	0 / -30	0 / -36	0 / -43	0 / -52	0 / -62	0 / -74	0 / -87
h10	0 / -40	0 / -48	0 / -58	0 / -70	0 / -84	0 / -100	0 / -120	0 / -140
h11	0 / -60	0 / -75	0 / -90	0 / -110	0 / -130	0 / -160	0 / -190	0 / -220
h12	0 / -100	0 / -120	0 / -150	0 / -180	0 / -210	0 / -250	0 / -300	0 / -350
k10	+ 40 / 0	+ 48 / 0	+ 58 / 0	+ 70 / 0	+ 84 / 0	+ 100 / 0	+ 120 / 0	+ 140 / 0
k12	+ 100 / 0	+ 120 / 0	+ 150 / 0	+ 180 / 0	+ 210 / 0	+ 250 / 0	+ 300 / 0	+ 350 / 0
m7	+ 2 / + 12	+ 4 / + 16	+ 6 / + 21	+ 7 / + 25	+ 8 / + 29	+ 9 / + 34	+ 11 / + 41	+ 13 / + 48
js14	+ / -125	+ / -150	+ / -180	+ / -215	+ / -260	+ / -310	+ / -370	+ / -435
js16	+ / -300	+ / -375	+ / -450	+ / -550	+ / -650	+ / -800	+ / -950	+ / -1100
H7	+ 10 / 0	+ 12 / 0	+ 15 / 0	+ 18 / 0	+ 21 / 0	+ 25 / 0	+ 30 / 0	+ 35 / 0
H8	+ 14 / 0	+ 18 / 0	+ 22 / 0	+ 27 / 0	+ 33 / 0	+ 39 / 0	+ 46 / 0	+ 54 / 0
H9	+ 25 / 0	+ 30 / 0	+ 36 / 0	+ 43 / 0	+ 52 / 0	+ 62 / 0	+ 74 / 0	+ 87 / 0
H12	+ 100 / 0	+ 120 / 0	+ 150 / 0	+ 180 / 0	+ 210 / 0	+ 250 / 0	+ 300 / 0	+ 350 / 0
P9	-6 / -31	-12 / -42	-15 / -51	-18 / -61	-22 / -74	-26 / -86	-32 / -106	-37 / -124
S7	-13 / -22	-15 / -27	-17 / -32	-21 / -39	-27 / -48	-34 / -59	-42 / -72	-58 / -93



INFORMACIÓN TÉCNICA GENERAL

Tabla de velocidades de corte

		Vc															
m/min		5	8	10	15	20	25	30	40	50	60	70	80	90	100	110	150
SFM (pies/min)		16	26	32	50	66	82	98	130	165	197	230	262	296	330	362	495
Ø		RPM															
mm	pulgadas																
1.00	—	1592	2546	3183	4775	6366	7958	9549	12732	15916	19099	22282	25465	28648	31831	35014	47747
1.50	—	1061	1698	2122	3183	4244	5305	6366	8488	10610	12732	14854	16977	19099	21221	23343	31831
2.00	—	796	1273	1592	2387	3183	3979	4775	6366	7958	9549	11141	12732	14324	15916	17507	23873
2.50	—	637	1019	1273	1910	2546	3183	3820	5093	6366	7639	8913	10186	11459	12732	14006	19099
3.00	—	531	849	1061	1592	2122	2653	3183	4244	5305	6366	7427	8488	9549	10610	11671	15916
3.18	1/8	500	801	1001	1501	2002	2502	3003	4004	5005	6006	7007	8008	9009	10010	11011	15015
3.50	—	455	728	909	1364	1819	2274	2728	3638	4547	5457	6366	7276	8185	9095	10004	13642
4.00	—	398	637	796	1194	1592	1989	2387	3183	3979	4775	5570	6366	7162	7958	8754	11937
4.50	—	354	566	707	1061	1415	1768	2122	2829	3537	4244	4951	5659	6366	7074	7781	10610
4.76	3/16	334	535	669	1003	1337	1672	2006	2675	3344	4012	4681	5350	6018	6687	7356	10031
5.00	—	318	509	637	955	1273	1592	1910	2546	3183	3820	4456	5093	5730	6366	7003	9549
6.00	—	265	424	531	796	1061	1326	1592	2122	2653	3183	3714	4244	4775	5305	5836	7958
6.35	1/4	251	401	501	752	1003	1253	1504	2005	2506	3008	3509	4010	4511	5013	5514	7519
7.00	—	227	364	455	682	909	1137	1364	1819	2274	2728	3183	3638	4093	4547	5002	6821
7.94	5/16	200	321	401	601	802	1002	1203	1604	2004	2405	2806	3207	3608	4009	4410	6013
8.00	—	199	318	398	597	796	995	1194	1592	1989	2387	2785	3183	3581	3979	4377	5968
9.00	—	177	283	354	531	707	884	1061	1415	1768	2122	2476	2829	3183	3537	3890	5305
9.53	3/8	167	267	334	501	668	835	1002	1336	1670	2004	2338	2672	3006	3340	3674	5010
10.00	—	159	255	318	477	637	796	955	1273	1592	1910	2228	2546	2865	3183	3501	4775
11.11	7/16	143	229	287	430	573	716	860	1146	1433	1719	2006	2292	2579	2865	3152	4298
12.00	—	133	212	265	398	531	663	796	1061	1326	1592	1857	2122	2387	2653	2918	3979
12.70	1/2	125	201	251	376	501	627	752	1003	1253	1504	1754	2005	2256	2506	2757	3760
14.00	—	114	182	227	341	455	568	682	909	1137	1364	1592	1819	2046	2274	2501	3410
14.29	9/16	111	178	223	334	446	557	668	891	1114	1337	1559	1782	2005	2228	2450	3341
15.00	—	106	170	212	318	424	531	637	849	1061	1273	1485	1698	1910	2122	2334	3183
15.88	5/8	100	160	200	301	401	501	601	802	1002	1203	1403	1604	1804	2004	2205	3007
16.00	—	99	159	199	298	398	497	597	796	995	1194	1393	1592	1790	1989	2188	2984
17.46	11/16	91	146	182	273	365	456	547	729	912	1094	1276	1458	1641	1823	2005	2735
18.00	—	88	141	177	265	354	442	531	707	884	1061	1238	1415	1592	1768	1945	2653
19.05	3/4	84	134	167	251	334	418	501	668	835	1003	1170	1337	1504	1671	1838	2506
20.00	—	80	127	159	239	318	398	477	637	796	955	1114	1273	1432	1592	1751	2387
24.00	—	66	106	133	199	265	332	398	531	663	796	928	1061	1194	1326	1459	1989
25.00	—	64	102	127	191	255	318	382	509	637	764	891	1019	1146	1273	1401	1910
27.00	—	59	94	118	177	236	295	354	472	589	707	825	943	1061	1179	1297	1768
30.00	—	53	85	106	159	212	265	318	424	531	637	743	849	955	1061	1167	1592
32.00	—	50	80	99	149	199	249	298	398	497	597	696	796	895	995	1094	1492
36.00	—	44	71	88	133	177	221	265	354	442	531	619	707	796	884	973	1326
40.00	—	40	64	80	119	159	199	239	318	398	477	557	637	716	796	875	1194
50.00	—	32	51	64	95	127	159	191	255	318	382	446	509	573	637	700	955



INFORMACIÓN TÉCNICA GENERAL

Dureza y resistencia a la tracción

HV	HRC	HB	Resistencia	
			N/mm ²	Toneladas/sq. in.
940	68	–	–	–
900	67	–	–	–
864	66	–	–	–
829	65	–	–	–
800	64	–	–	–
773	63	–	–	–
745	62	–	–	–
720	61	–	–	–
698	60	–	–	–
675	59	–	–	–
655	58	–	2200	142
650	–	618	2180	141
640	–	608	2145	139
639	57	607	2140	138
630	–	599	2105	136
620	–	589	2070	134
615	56	584	2050	133
610	–	580	2030	131
600	–	570	1995	129
596	55	567	1980	128
590	–	561	1955	126
580	–	551	1920	124
578	54	549	1910	124
570	–	542	1880	122
560	53	532	1845	119
550	–	523	1810	117
544	52	517	1790	116
540	–	513	1775	115
530	–	504	1740	113
527	51	501	1730	112
520	–	494	1700	110
514	50	488	1680	109
510	–	485	1665	108
500	–	475	1630	105
497	49	472	1620	105
490	–	466	1595	103
484	48	460	1570	102
480	–	456	1555	101
473	47	449	1530	99
470	–	447	1520	98
460	–	437	1485	96
458	46	435	1480	96
450	–	428	1455	94
446	45	424	1440	93
440	–	418	1420	92

HV	HRC	HB	Resistencia	
			N/mm ²	Toneladas/sq. in.
434	44	413	1400	91
423	43	402	1360	88
413	42	393	1330	86
403	41	383	1300	84
392	40	372	1260	82
382	39	363	1230	80
373	38	354	1200	78
364	37	346	1170	76
355	36	337	1140	74
350	–	333	1125	73
345	35	328	1110	72
340	–	323	1095	71
336	34	319	1080	70
330	–	314	1060	69
327	33	311	1050	68
320	–	304	1030	67
317	32	301	1020	66
310	31	295	995	64
302	30	287	970	63
300	–	285	965	62
295	–	280	950	61
293	29	278	940	61
290	–	276	930	60
287	28	273	920	60
285	–	271	915	59
280	27	266	900	58
275	–	261	880	57
272	26	258	870	56
270	–	257	865	56
268	25	255	860	56
265	–	252	850	55
260	24	247	835	54
255	23	242	820	53
250	22	238	800	52
245	–	233	785	51
243	21	231	780	50
240	–	228	770	50
235	–	223	755	49
230	–	219	740	48
225	–	214	720	47
220	–	209	705	46
215	–	204	690	45
210	–	199	675	44
205	–	195	660	43
200	–	190	640	41



DORMER PRAMET



BÚSQUEDA RÁPIDA

Realice una búsqueda de texto de forma fácil y rápida dentro de cualquier publicación de Dormer Pramet de los últimos años a través de nuestra aplicación de biblioteca. Descárguela hoy mismo en su tienda de aplicaciones. **Simplemente fiables.**

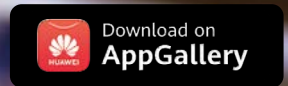



BROCAS DE PLAQUITA INTERCAMBIABLE



VISION GENERAL DE LAS BROCAS INDEXABLES

Longitud util	2×D	3×D	4×D	5×D	XPET..AP	SCET..UD	XPET..AP-SD	SCET..-SD
Foto								
Refrigeración					-	-	-	-
	313	315	318	320	324	323	324	323
Tipo de broca	802D	803D	804D	805D	-	-	-	-
Tolerancia de la broca	± 0.05	± 0.05	± 0.05	± 0.05	-	-	-	-
Tolerancia del agujero *	0/+0.2	0/+0.3	0/+0.4	0/+0.5	-	-	-	-
Acabado superficial *	R _a 2-6 μm	R _a 2-6 μm	R _a 2-6 μm	R _a 2-6 μm	-	-	-	-
Campo de diámetros	15.0-40.0	15.0-58.0	17.0-58.0	19.0-31.0	-	-	-	-
Área de aplicación	P1	■	■	■	■	■	■	■
	P2	■	■	■	■	■	■	■
	P3	■	■	■	■	■	■	■
	P4	■	■	■	■	■	■	■
	M1						■	■
	M2						■	■
	M3						■	■
	M4						■	■
	K1	▣	■	▣	▣	▣	▣	▣
	K2	▣	■	▣	▣	▣	▣	▣
	K3	▣	■	▣	▣	▣	▣	▣
	K4	▣	■	▣	▣	▣	▣	▣
	K5	▣	■	▣	▣	▣	▣	▣
S1						▣	▣	
S2						▣	▣	
S3						▣	▣	
S4						▣	▣	

* La tolerancia del agujero y el acabado superficial dependen en gran medida de las condiciones de mecanizado



BROCAS DE PLAQUITA INTERCAMBIABLE: NAVEGADOR DE CALIDADES

Identificación de la calidad	Área de aplicación	Aplicación	Avance	Velocidad de corte	Resistencia a condiciones de trabajo adversas	Recubrimiento	Color	Sustrato	Ventajas del refrigerante	Descripción de la calidad
D9335	P20 - P35	■				MT-CVD	■	FGM	+++	Esta calidad se recomienda para plaquitas de corte periféricas en brocas de plaquita intercambiable; es más adecuada para velocidades de corte y avances elevados.
	M15 - M30	■								
	K15 - K35	■								
	S10 - S20	■								
D8330	P20 - P35	■				PVD	■	submicron H	+++	Se trata de una calidad universal para la plaquita de corte periférica en brocas de plaquita intercambiable; se puede utilizar en la mayoría de materiales y destaca por su fiabilidad de funcionamiento.
	M15 - M30	■								
	K15 - K35	■								
	S10 - S20	■								
D8345	P30 - P50	■				PVD	■	submicron H	+++	Se trata de una calidad universal para la plaquita de corte central en brocas de plaquita intercambiable; es extremadamente resistente, por lo que es válida para la mayoría de materiales existentes.
	M20 - M40	■								
	K30 - K40	■								
	S20 - S30	■								

Sustrato

submicron H	Sustrato de base WC-Co de grano fino (< 1 µm)
FGM	Sustrato de grado funcional

Recubrimiento

MT-CVD	Método de recubrimiento químico a media temperatura
PVD	Método de recubrimiento físico

Ventajas del refrigerante

+++	Uso esencial de refrigerante
-----	------------------------------

PLAQUITAS – DESIGNACIÓN CÓDIGO ISO

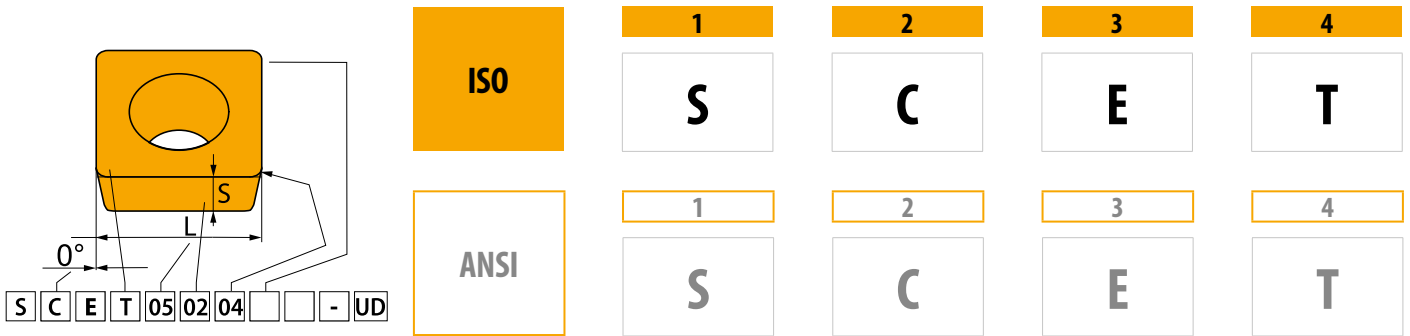

1				2				4														
Forma de plaquita				Ángulo de incidencia				Tipo de plaquita														
H	O	P	R	A	B	C	D	N	R	F	A	M	G	W	T	Q	U	B	H	C	J	X
S	T	C	D	E	F	G	N															
E	M	V	W																			
L	A	B	K	P	O		Especial															

3 3 Tolerancias

	(mm)			(")		
	M(±)	S(±)	IC(±)	M(±)	S(±)	IC(±)
A	0.005	0.025	0.025	.0002"	.001"	.0010"
F	0.005	0.025	0.013	.0002"	.001"	.0005"
C	0.013	0.025	0.025	.0005"	.001"	.0010"
H	0.013	0.025	0.013	.0005"	.001"	.0005"
E	0.025	0.025	0.025	.0010"	.001"	.0010"
G	0.025	0.130	0.025	.0010"	.005"	.0010"
J	0.005	0.025	0.05 – 0.13	.0002"	.001"	.002 – 0.005"
K	0.013	0.025	0.05 – 0.13	.0005"	.001"	.002 – 0.005"
L	0.025	0.025	0.05 – 0.13	.0010"	.001"	.002 – 0.005"
M	0.08 – 0.18	0.130	0.05 – 0.13	.003 – 0.007"	.005"	.002 – 0.005"
N	0.08 – 0.18	0.025	0.05 – 0.13	.003 – 0.007"	.001"	.002 – 0.005"
U	0.05 – 0.38	0.130	0.05 – 0.13	.005 – 0.015"	.005"	.003 – 0.010"

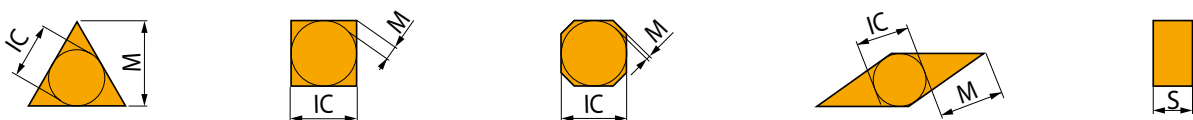



PLAQUITAS – DESIGNACIÓN CÓDIGO ISO

5	6	7	8	9	10
05	02	04			UD
5	6	7	8	9	10
1.8	1.5	1			UD

5		5												
Longitud del filo de corte (tamaño de plaqueta)														
d=IC		H	O	P	S	T	C	D	E	M	V	W	R	K
(mm)	(in)													
3.97	5/32"				03	06		04			06	02		
4.76	3/16"				04	08	04	05	04	04	08	L3		
5.56	7/32"				05	09	05	06	05	05	09	03		
6.35	1/4"	03	02	04	08	11	06	07	08	08	11	04	06	
7.94	5/16"	04	03	05	07	13	08	09	06	07	13	05	07	
9.525	3/8"	05	04	07	09	16	09	11	09	09	16	06	09	16
12.7	1/2"	07	05	09	12	22	12	15	13	12	22	08	12	
15.875	5/8"	09	06	11	15	27	16	19	16	15	27	10	15	
19.05	3/4"	11	07	13	19	33	19	23	19	19	33	13	19	
25.40	1"	14	10	18	25	44	25	31	26	25	44	17	25	
31.75	1 1/4"	18	13	23	31	54	32	38	32	31	54	21	31	

6		7	
Espesor		Radio de punta	
		RE	
		(mm)	(")
01	1.59	0	0"
T1	1.98	0.2	1/128"
02	2.38	0.4	1/64"
03	3.18	0.8	1/32"
04	3.97	1.2	3/64"
05	4.76	1.6	1/16"
06	5.56	2.4	3/32"
07	7.94	3.2	1/8"
09	9.52		

6		7	
Espesor		Radio de punta	
		RE	
		(mm)	(")
01	1.59	0	0"
T1	1.98	0.2	1/128"
02	2.38	0.4	1/64"
03	3.18	0.8	1/32"
04	3.97	1.2	3/64"
05	4.76	1.6	1/16"
06	5.56	2.4	3/32"
07	7.94	3.2	1/8"
09	9.52		

6		7	
Espesor		Radio de punta	
		RE	
		(mm)	(")
01	1.59	0	0"
T1	1.98	0.2	1/128"
02	2.38	0.4	1/64"
03	3.18	0.8	1/32"
04	3.97	1.2	3/64"
05	4.76	1.6	1/16"
06	5.56	2.4	3/32"
07	7.94	3.2	1/8"
09	9.52		

ANSI					
5		6		7	
Círculo inscrito		Espesor		Radio de punta	
Symbol	d=I.C.	Symbol	S	Symbol	RE
	(mm)	(mm)	(")	(mm)	(")
1	3.175	1	1.588	0	0"
1.2	3.969	1.2	1.984	0.099	1/256"
1.5	4.763	1.5	2.381	0.198	1/128"
1.8	5.556	2	3.175	0.397	1/64"
2	6.350	2.5	3.969	0.794	1/32"
2.5	7.938	3	4.763	1.191	3/64"
3	9.525	3.5	5.556	1.588	1/16"
4	12.700	4	6.350	1.984	5/64"
5	15.875	5	7.938	2.381	3/32"
6	19.050	6	9.525	3.175	1/8"
7	22.225	7	11.113	3.969	5/32"
8	25.400	8	12.700	4.763	3/16"
10	31.750	9	14.288	5.556	7/32"
12	38.100	10	15.875	6.350	1/4"

8		8	
Condición del filo de corte			
	Filos vivos		Filos redondeados
	Filos con faceta		Filo redondeado con faceta
	Filos con doble faceta		Filos redondeados con doble faceta

9		9	
Dirección de avance			
R	Avance ←	N	Avance ← Avance →
L	Avance →		

10		10	
Designación del rompevirutas			



MARCADO DE LAS BROCAS

1	2	3		4		5		6	7
8	05	D	-	19	-	95	-	S	25

*Marcaje válido para tipos producidos a partir de 2011



Brocas con plaquitas*

1		2		3		4	
Tipo de herramienta		Longitud aproximada		Variante		Diámetro de corte	
8	Broca intercambiable	02	2 × DC	D	Broca	15.5	DC=5,5mm
		03	3 × DC			19	DC=19mm
		04	4 × DC				
		05	5 × DC				
5		6		7			
Profundidad de taladrado máx.		Tipo de mango		Diámetro del mango			
35	35 mm	E	Whistle Notch	25	DCON MS = 25 mm		
95	95 mm			32	DCON MS = 32 mm		
140	140 mm	S	ISO 9766	40	DCON MS = 40 mm		



802D

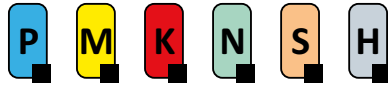

PRAMET

S



Cuerpo de Broca 802D de placa intercambiable 2XD con Refrigeración Interna

Cuerpo de broca de plaquitas intercambiables de alto rendimiento para taladrar agujeros ciegos y pasantes. Potencialmente también taladrado de agujeros cruzados, descentrados y en paquetes de chapas, interpolación helicoidal, fresado axial (plunge), taladrado en superficies cóncavas o en ángulo, taladrado con cortes interrumpidos, achaflanado y mandrinado. Disponible desde Ø15 hasta Ø40 mm en 2xD.

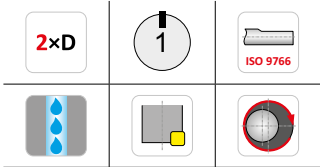
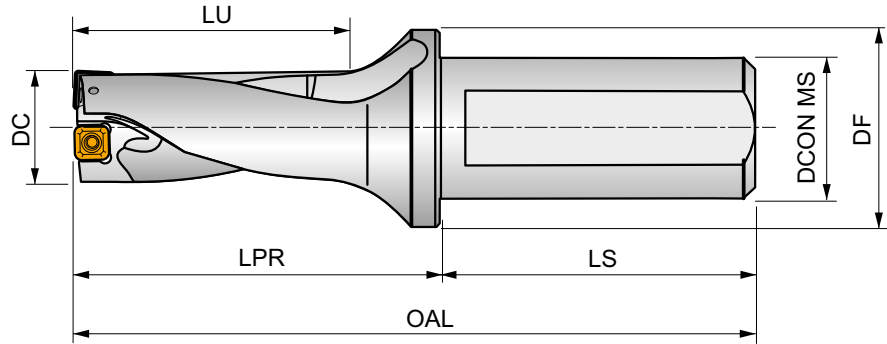

Producto	DC	APMX	OAL	LPR	LS	LU	DCON MS	DF	$\overset{-}{D}$	$\overset{+}{D}$				kg	
	(mm)	(mm)	(mm)	(mm)	(mm)	(mm)	(mm)	(mm)	(mm)	(mm)					
802D-15-30-S25	15	30.00	121	65	56	34.5	25	35	0.25	0.35	EP253253	GI300	GI313	0.30	HM001
802D-16-32-S25	16	32.00	123	67	56	37	25	35	0.15	0.45	EP253253	GI300	GI313	0.30	HM001
802D-17-34-S25	17	34.00	125	69	56	39.5	25	35	0.10	0.50	EP253253	GI300	GI313	0.31	HM001
802D-18-36-S25	18	36.00	127	71	56	42	25	35	0.35	0.25	EP253253	GI301	GI314	0.31	HM002
802D-19-38-S25	19	38.00	129	73	56	44.5	25	35	0.15	0.45	EP253253	GI301	GI314	0.32	HM002
802D-20-40-S25	20	40.00	131	75	56	47	25	35	0.10	0.45	EP253253	GI302	GI315	0.33	HM003
802D-21-42-S25	21	42.00	133	77	56	49.5	25	35	0.10	0.50	EP253253	GI302	GI315	0.34	HM003
802D-22-44-S25	22	44.00	135	79	56	52	25	35	0.45	0.50	EP253253	GI303	GI316	0.35	HM004
802D-23-46-S25	23	46.00	137	81	56	54.5	25	35	0.35	0.50	EP253253	GI304	GI317	0.36	HM005
802D-24-48-S25	24	48.00	139	83	56	57	25	35	0.15	0.50	EP253253	GI304	GI317	0.37	HM005
802D-25-50-S32	25	50.00	145	85	60	57	32	42	0.15	0.50	EP324058	GI304	GI317	0.57	HM005
802D-26-52-S32	26	52.00	147	87	60	59.5	32	42	0.10	0.50	EP324058	GI304	GI317	0.58	HM005
802D-27-54-S32	27	54.00	149	89	60	62	32	42	0.50	0.30	EP324058	GI305	GI318	0.59	HM006
802D-28-56-S32	28	56.00	151	91	60	64.5	32	42	0.30	0.50	EP324058	GI306	GI319	0.61	HM007
802D-29-58-S32	29	58.00	153	93	60	67	32	42	0.20	0.50	EP324058	GI306	GI319	0.62	HM007
802D-30-60-S32	30	60.00	155	95	60	69.5	32	42	0.15	0.50	EP324058	GI306	GI319	0.67	HM007
802D-32-64-S32	32	64.00	159	99	60	70	32	42	0.50	0.35	EP324058	GI307	GI320	0.68	HM008
802D-32-64-S40	32	64.00	167	99	68	70	40	50	0.50	0.35	-	GI307	GI320	1.03	HM008
802D-34-68-S32	34	68.00	163	103	60	75	32	42	0.25	0.50	EP324058	GI307	GI320	0.73	HM008
802D-34-68-S40	34	68.00	171	103	68	75	40	50	0.25	0.50	-	GI307	GI320	1.07	HM008
802D-36-72-S32	36	72.00	167	107	60	80	32	42	0.10	0.50	EP324058	GI308	GI321	0.76	HM009
802D-36-72-S40	36	72.00	173	105	68	77.5	40	50	0.10	0.50	-	GI308	GI321	1.11	HM009
802D-38-76-S32	38	76.00	171	111	60	85	32	42	0.50	0.50	EP324058	GI308	GI321	0.83	HM009
802D-38-76-S40	38	76.00	179	111	68	85	40	50	0.50	0.50	-	GI308	GI321	1.17	HM009
802D-40-80-S32	40	80.00	175	115	60	90	32	42	0.20	0.50	EP324058	GI309	GI322	0.91	HM009
802D-40-80-S40	40	80.00	183	115	68	90	40	50	0.20	0.50	-	GI309	GI322	1.25	HM009



GI300	XPET 0502AP	SCET 050204-UD
GI301	XPET 0602AP	SCET 050204-UD
GI302	XPET 0602AP	SCET 060204-UD
GI303	XPET 0703AP	SCET 060204-UD
GI304	XPET 0703AP	SCET 070308-UD
GI305	XPET 0903AP	SCET 070308-UD
GI306	XPET 0903AP	SCET 09T308-UD
GI307	XPET 11T3AP	SCET 09T308-UD
GI308	XPET 11T3AP	SCET 120408-UD
GI309	XPET 12T3AP	SCET 120408-UD
GI313	XPET 0502AP-SD	SCET 050204-SD
GI314	XPET 0602AP-SD	SCET 050204-SD
GI315	XPET 0602AP-SD	SCET 060204-SD
GI316	XPET 0703AP-SD	SCET 060204-SD
GI317	XPET 0703AP-SD	SCET 070308-SD
GI318	XPET 0903AP-SD	SCET 070308-SD
GI319	XPET 0903AP-SD	SCET 09T308-SD
GI320	XPET 11T3AP-SD	SCET 09T308-SD
GI321	XPET 11T3AP-SD	SCET 120408-SD
GI322	XPET 12T3AP-SD	SCET 120408-SD

HM001	US 2245-T07P	0.9	US 2245-T07P	0.9	FLAG T07P
HM002	US 2205-T07P	0.9	US 2245-T07P	0.9	FLAG T07P
HM003	US 2205-T07P	0.9	US 2205-T07P	0.9	FLAG T07P
HM004	US 2506-T07P	1.2	US 2506-T07P	1.2	FLAG T07P
HM005	US 2507-T08P	1.2	US 3007-T08P	2.0	FLAG T08P
HM006	US 3007-T09P	2.0	US 3007-T09P	2.0	FLAG T09P
HM007	US 3007-T09P	2.0	US 3009-T09P	2.0	FLAG T09P
HM008	US 3510-T15P	3.0	US 3508-T15P	3.0	FLAG T15P
HM009	US 3510-T15P	3.0	US 5012-T15P	5.0	FLAG T15P



803D



PRAMET

S



Cuerpo de Broca 803D de placa intercambiable 3XD con Refrigeración Interna

Cuerpo de broca de plaquitas intercambiables de alto rendimiento para taladrar agujeros ciegos y pasantes. Potencialmente también taladrado de agujeros cruzados, descentrados y en paquetes de chapas, interpolación helicoidal, fresado axial (plunge), taladrado en superficies cóncavas o en ángulo, taladrado con cortes interrumpidos, achaflanado y mandrinado. Disponible desde Ø15 hasta Ø58 mm en 3xD.

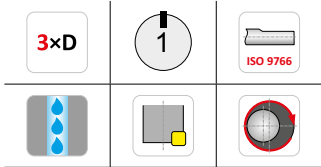
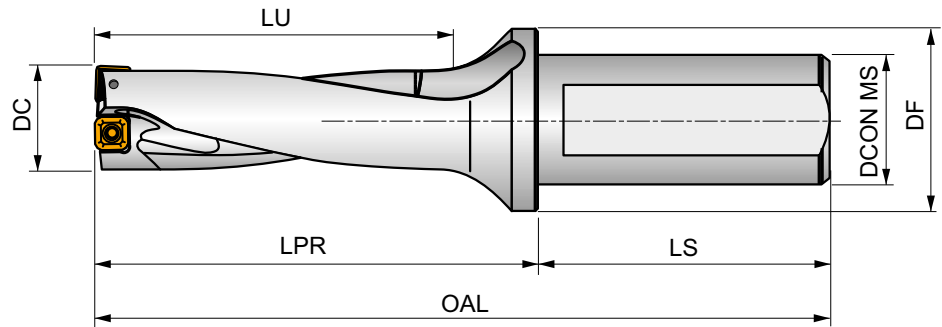

Producto	DC	APMX	OAL	LPR	LS	LU	DCON MS	DF	\bar{D}	\bar{D}^+				kg	
	(mm)	(mm)	(mm)	(mm)	(mm)	(mm)	(mm)	(mm)	(mm)	(mm)					
803D-15-45-S25	15	45.00	136	80	56	49.5	25	35	0.25	0.35	EP253253	GI300	GI313	0.31	HM001
803D-15,5-46,5-S25	15.5	47.00	137.5	81.5	56	51.2	25	35	0.30	0.35	EP253253	GI300	GI313	0.31	HM001
803D-16-48-S25	16	48.00	139	83	56	53	25	35	0.15	0.45	EP253253	GI300	GI313	0.32	HM001
803D-16,5-49,5-S25	16.5	50.00	140.5	84.5	56	54.7	25	35	0.15	0.40	EP253253	GI300	GI313	0.32	HM001
803D-17-51-S25	17	51.00	142	86	56	56.5	25	35	0.10	0.50	EP253253	GI300	GI313	0.32	HM001
803D-17,5-52,5-S25	17.5	53.00	143.5	87.5	56	58.2	25	35	0.50	0.50	EP253253	GI301	GI314	0.32	HM002
803D-18-54-S25	18	54.00	145	89	56	60	25	35	0.35	0.25	EP253253	GI301	GI314	0.33	HM002
803D-18,5-55,5-S25	18.5	56.00	146.5	90.5	56	61.2	25	35	0.35	0.25	EP253253	GI301	GI314	0.34	HM002
803D-19-57-S25	19	57.00	148	92	56	63.5	25	35	0.15	0.45	EP253253	GI301	GI314	0.34	HM002
803D-19,5-58,5-S25	19.5	59.00	149.5	93.5	56	63.7	25	35	0.25	0.40	EP253253	GI302	GI315	0.34	HM003
803D-20-60-S25	20	60.00	151	95	56	67	25	35	0.10	0.45	EP253253	GI302	GI315	0.35	HM003
803D-20,5-61,5-S25	20.5	62.00	152.5	96.5	56	67.2	25	35	0.10	0.50	EP253253	GI302	GI315	0.36	HM003
803D-21-63-S25	21	63.00	154	98	56	70.5	25	35	0.10	0.50	EP253253	GI302	GI315	0.36	HM003
803D-21,5-64,5-S25	21.5	65.00	155.5	99.5	56	70.8	25	35	0.35	0.50	EP253253	GI303	GI316	0.37	HM004
803D-22-66-S25	22	66.00	157	101	56	74	25	35	0.45	0.50	EP253253	GI303	GI316	0.38	HM004
803D-22,5-67,5-S25	22.5	68.00	158.5	102.5	56	74.3	25	35	0.35	0.50	EP253253	GI304	GI317	0.39	HM005
803D-23-69-S25	23	69.00	160	104	56	77.5	25	35	0.35	0.50	EP253253	GI304	GI317	0.40	HM005
803D-23,5-70,5-S25	23.5	71.00	161.5	105.5	56	77.6	25	35	0.10	0.50	EP253253	GI304	GI317	0.40	HM005
803D-24-72-S25	24	72.00	163	107	56	81	25	35	0.15	0.50	EP253253	GI304	GI317	0.41	HM005
803D-24,5-73,5-S25	24.5	74.00	168.5	108.5	60	78.7	25	35	0.10	0.50	EP253253	GI304	GI317	0.42	HM005
803D-25-75-S32	25	75.00	170	110	60	82	32	42	0.15	0.50	EP324058	GI304	GI317	0.62	HM005
803D-25,5-76,5-S32	25.5	77.00	171.5	111.5	60	82.2	32	42	0.50	0.10	EP324058	GI304	GI317	0.63	HM005
803D-26-78-S32	26	78.00	173	113	60	85.5	32	42	0.10	0.50	EP324058	GI304	GI317	0.64	HM005
803D-26,5-79,5-S32	26.5	80.00	174.5	114.5	60	85.7	32	42	0.50	0.10	EP324058	GI305	GI318	0.65	HM006
803D-27-81-S32	27	81.00	176	116	60	89	32	42	0.50	0.30	EP324058	GI305	GI318	0.65	HM006
803D-28-84-S32	28	84.00	179	119	60	92.5	32	42	0.30	0.50	EP324058	GI306	GI319	0.68	HM007
803D-29-87-S32	29	87.00	182	122	60	96	32	42	0.20	0.50	EP324058	GI306	GI319	0.70	HM007



Producto	DC	APMX	OAL	LPR	LS	LU	DCOMMS	DF	\bar{D}	D^+					
	(mm)	(mm)	(mm)	(mm)	(mm)	(mm)		(mm)	(mm)	(mm)					
803D-30-90-S32	30	90.00	185	125	60	99.5	32	42	0.15	0.50	EP324058	GI306	GI319	0.73	HM007
803D-31-93-S32	31	93.00	188	128	60	103	32	42	0.15	0.50	EP324058	GI306	GI319	0.76	HM007
803D-32-96-S32	32	96.00	191	131	60	102	32	42	0.50	0.30	EP324058	GI307	GI320	0.79	HM008
803D-32-96-S40	32	96.00	199	131	68	102	40	50	0.50	0.30	-	GI307	GI320	1.14	HM008
803D-33-99-S32	33	99.00	194	134	60	105.5	32	42	0.50	0.50	EP324058	GI307	GI320	0.83	HM008
803D-33-99-S40	33	99.00	202	134	68	105.5	40	50	0.50	0.50	-	GI307	GI320	1.18	HM008
803D-34-102-S32	34	102.00	197	137	60	109	32	42	0.25	0.50	EP324058	GI307	GI320	0.86	HM008
803D-34-102-S40	34	102.00	205	137	68	109	40	50	0.25	0.50	-	GI307	GI320	1.12	HM008
803D-35-105-S32	35	105.00	200	140	60	112.5	32	42	0.25	0.50	EP324058	GI308	GI321	0.90	HM009
803D-35-105-S40	35	105.00	208	140	68	112.5	40	50	0.25	0.50	-	GI308	GI321	1.24	HM009
803D-36-108-S32	36	108.00	203	143	60	116	32	42	0.10	0.50	EP324058	GI308	GI321	0.91	HM009
803D-36-108-S40	36	108.00	211	143	68	116	40	50	0.10	0.50	-	GI308	GI321	1.25	HM009
803D-37-111-S32	37	111.00	206	146	60	119.5	32	42	0.10	0.50	EP324058	GI308	GI321	0.95	HM009
803D-37-111-S40	37	111.00	214	146	68	119.5	40	50	0.10	0.50	-	GI308	GI321	1.29	HM009
803D-38-114-S32	38	114.00	199	139	60	124.5	32	42	0.50	0.50	EP324058	GI308	GI321	1.00	HM009
803D-38-114-S40	38	114.00	217	149	68	123	40	50	0.50	0.50	-	GI308	GI321	1.34	HM009
803D-39-117-S32	38	114.00	209	149	60	123	32	42	0.40	0.50	EP324058	GI309	GI322	1.06	HM009
803D-39-117-S40	39	117.00	220	152	68	126.5	40	50	0.40	0.50	-	GI309	GI322	1.40	HM009
803D-40-120-S32	40	120.00	215	155	60	130	32	42	0.20	0.50	EP324058	GI309	GI322	1.12	HM009
803D-40-120-S40	40	120.00	223	155	68	130	40	50	0.20	0.50	-	GI309	GI322	1.46	HM009
803D-41-123-S40	41	123.00	219	149	70	133	40	50	0.20	0.50	-	GI309	GI322	1.48	HM009
803D-42-126-S40	42	126.00	221.5	152	70	136	40	50	0.15	0.50	-	GI309	GI322	1.52	HM009
803D-43-129-S40	43	129.00	224	154	70	139	40	50	0.10	0.50	-	GI309	GI322	1.58	HM009
803D-44-132-S40	44	132.00	226.5	157	70	142	40	50	0.50	0.50	-	GI310	GI323	1.63	HM010
803D-45-135-S40	45	135.00	230.5	161	70	144	40	55	0.50	0.50	-	GI311	GI324	1.73	HM010
803D-46-138-S40	46	138.00	235	165	70	148	40	55	0.50	0.50	-	GI311	GI324	1.82	HM010
803D-47-141-S40	47	141.00	237.5	168	70	151	40	55	0.50	0.50	-	GI311	GI324	1.90	HM010
803D-48-144-S40	48	144.00	240	170	70	154	40	55	0.50	0.50	-	GI311	GI324	1.98	HM010
803D-49-147-S40	49	147.00	242.5	173	70	157	40	55	0.30	0.50	-	GI311	GI324	2.06	HM010
803D-50-150-S40	50	150.00	246.5	177	70	160	40	58	0.15	0.50	-	GI311	GI324	2.18	HM010
803D-51-153-S40	51	153.00	249	179	70	163	40	58	0.15	0.50	-	GI311	GI324	2.24	HM010
803D-52-156-S40	52	156.00	251.5	182	70	166	40	58	0.50	0.50	-	GI312	GI325	2.20	HM010
803D-53-159-S40	53	159.00	254	184	70	169	40	58	0.50	0.50	-	GI312	GI325	2.29	HM010
803D-54-162-S40	54	162.00	257.5	188	70	173	40	58	0.50	0.50	-	GI312	GI325	2.39	HM010
803D-55-165-S40	55	165.00	260	190	70	176	40	58	0.50	0.50	-	GI312	GI325	2.46	HM010
803D-56-168-S40	56	168.00	264	194	70	179	40	58	0.50	0.50	-	GI312	GI325	2.59	HM010
803D-57-171-S40	57	171.00	266.5	197	70	182	40	58	0.35	0.50	-	GI312	GI325	2.70	HM010
803D-58-174-S40	58	174.00	270	200	70	186	40	58	0.15	0.50	-	GI312	GI325	2.83	HM010

GI300	XPET 0502AP	SCET 050204-UD
GI301	XPET 0602AP	SCET 050204-UD
GI302	XPET 0602AP	SCET 060204-UD
GI303	XPET 0703AP	SCET 060204-UD
GI304	XPET 0703AP	SCET 070308-UD
GI305	XPET 0903AP	SCET 070308-UD
GI306	XPET 0903AP	SCET 09T308-UD
GI307	XPET 11T3AP	SCET 09T308-UD
GI308	XPET 11T3AP	SCET 120408-UD
GI309	XPET 12T3AP	SCET 120408-UD
GI310	XPET 1504AP	SCET 120408-UD
GI311	XPET 1504AP	SCET 150512-UD
GI312	XPET 1904AP	SCET 150512-UD
GI313	XPET 0502AP-SD	SCET 050204-SD
GI314	XPET 0602AP-SD	SCET 050204-SD
GI315	XPET 0602AP-SD	SCET 060204-SD
GI316	XPET 0703AP-SD	SCET 060204-SD
GI317	XPET 0703AP-SD	SCET 070308-SD
GI318	XPET 0903AP-SD	SCET 070308-SD
GI319	XPET 0903AP-SD	SCET 09T308-SD



GI320	XPET 11T3AP-SD	SCET 09T308-SD
GI321	XPET 11T3AP-SD	SCET 120408-SD
GI322	XPET 12T3AP-SD	SCET 120408-SD
GI323	XPET 1504AP-SD	SCET 120408-SD
GI324	XPET 1504AP-SD	SCET 150512-SD
GI325	XPET 1904AP-SD	SCET 150512-SD

HM001	US 2245-T07P	0.9	US 2245-T07P	0.9	FLAG T07P
HM002	US 2205-T07P	0.9	US 2245-T07P	0.9	FLAG T07P
HM003	US 2205-T07P	0.9	US 2205-T07P	0.9	FLAG T07P
HM004	US 2506-T07P	1.2	US 2506-T07P	1.2	FLAG T07P
HM005	US 2507-T08P	1.2	US 3007-T08P	2.0	FLAG T08P
HM006	US 3007-T09P	2.0	US 3007-T09P	2.0	FLAG T09P
HM007	US 3007-T09P	2.0	US 3009-T09P	2.0	FLAG T09P
HM008	US 3510-T15P	3.0	US 3508-T15P	3.0	FLAG T15P
HM009	US 3510-T15P	3.0	US 5012-T15P	5.0	FLAG T15P
HM010	US 4011-T15P	3.5	US 5012-T15P	5.0	FLAG T15P



804D

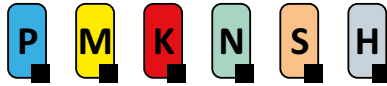

PRAMET

S



Cuerpo de Broca 804D de placa intercambiable 4XD con Refrigeración Interna

Cuerpo de broca de plaquitas intercambiables de alto rendimiento para taladrar agujeros ciegos y pasantes. Potencialmente también taladrado de agujeros cruzados, descentrados y en paquetes de chapas, interpolación helicoidal, fresado axial (plunge), taladrado en superficies cóncavas o en ángulo, taladrado con cortes interrumpidos, achaflanado y mandrinado. Disponible desde Ø17 hasta Ø58 mm en 4xD.

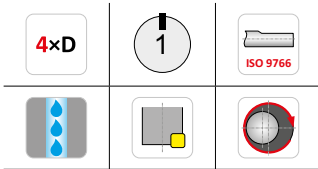
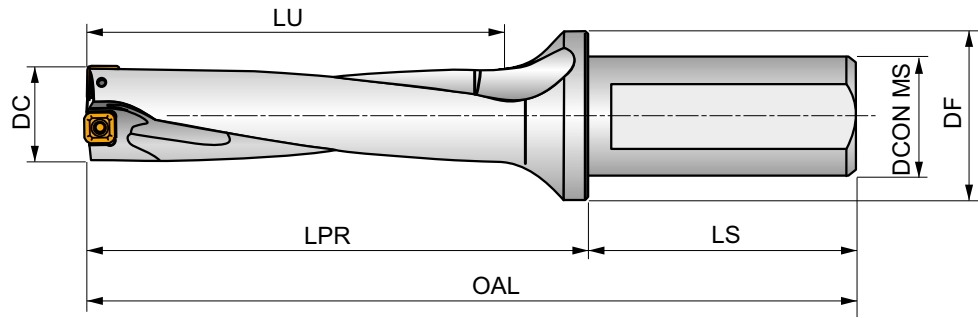

Producto	DC	APMX	OAL	LPR	LS	LU	DCON MS	DF	D ⁻	D ⁺	ISO 9766	ISO 9766	ISO 9766	kg	HM
	(mm)	(mm)	(mm)	(mm)	(mm)	(mm)	(mm)	(mm)	(mm)	(mm)					
804D-17-68-S25	17	68.00	149	93	56	73	25	35	0.10	0.50	-	GI300	GI313	0.34	HM001
804D-18-72-S25	18	72.00	153	97	56	77	25	35	0.35	0.25	-	GI301	GI314	0.35	HM002
804D-19-76-S25	19	76.00	157	101	56	81.5	25	35	0.15	0.45	-	GI301	GI314	0.36	HM002
804D-20-80-S25	20	80.00	161	105	56	85	25	35	0.10	0.45	-	GI302	GI315	0.37	HM003
804D-21-84-S25	21	84.00	165	109	56	89.5	25	35	0.10	0.50	-	GI302	GI315	0.39	HM003
804D-22-88-S25	22	88.00	169	113	56	94	25	35	0.45	0.50	-	GI303	GI316	0.41	HM004
804D-23-92-S25	23	92.00	173	117	56	98.5	25	35	0.35	0.50	-	GI304	GI317	0.44	HM005
804D-24-96-S25	24	96.00	177	121	56	103	25	35	0.15	0.50	-	GI304	GI317	0.45	HM005
804D-25-100-S32	25	100.00	185	125	60	105	32	42	0.15	0.50	-	GI304	GI317	0.67	HM005
804D-26-104-S32	26	104.00	189	129	60	109.5	32	42	0.10	0.50	-	GI304	GI317	0.70	HM005
804D-27-108-S32	27	108.00	193	133	60	114	32	42	0.50	0.30	-	GI305	GI318	0.71	HM006
804D-28-112-S32	28	112.00	197	137	60	118.5	32	42	0.30	0.50	-	GI306	GI319	0.75	HM007
804D-29-116-S32	29	116.00	201	141	60	123	32	42	0.20	0.50	-	GI306	GI319	0.78	HM007
804D-30-120-S32	30	120.00	205	145	60	127.5	32	42	0.15	0.50	-	GI306	GI319	0.82	HM007
804D-31-124-S32	31	124.00	209	149	60	132	32	42	0.15	0.50	-	GI306	GI319	0.85	HM007
804D-32-128-S32	32	128.00	213	153	60	136.5	32	42	0.50	0.30	-	GI307	GI320	0.90	HM008
804D-33-132-S32	33	132.00	217	157	60	141	32	42	0.50	0.50	-	GI307	GI320	0.95	HM008
804D-34-136-S32	34	136.00	221	161	60	145.5	32	42	0.25	0.50	-	GI307	GI320	0.99	HM008
804D-35-140-S32	35	140.00	225	165	60	149	32	42	0.25	0.50	-	GI308	GI321	1.04	HM009
804D-36-144-S32	36	144.00	229	169	60	153.5	32	42	0.10	0.50	-	GI308	GI321	1.05	HM009
804D-37-148-S32	37	148.00	233	173	60	158	32	42	0.10	0.50	-	GI308	GI321	1.11	HM009
804D-38-152-S32	38	152.00	237	177	60	162.5	32	42	0.50	0.50	-	GI308	GI321	1.18	HM009
804D-39-156-S32	39	156.00	241	181	60	167	32	42	0.40	0.50	-	GI309	GI322	1.25	HM009
804D-40-160-S32	40	160.00	245	185	60	171.5	32	42	0.20	0.50	-	GI309	GI322	1.33	HM009
804D-41-164-S40	41	164.00	259	189	70	172	40	50	0.20	0.50	-	GI309	GI322	1.68	HM009
804D-42-168-S40	42	168.00	263	193	70	176.5	40	50	0.15	0.50	-	GI309	GI322	1.76	HM009
804D-43-172-S40	43	172.00	267	197	70	181	40	50	0.10	0.50	-	GI309	GI322	1.83	HM009



Producto	DC	APMX	OAL	LPR	LS	LU	DCON/MS	DF	D ⁻	D ⁺					
	(mm)	(mm)	(mm)	(mm)	(mm)	(mm)	(mm)	(mm)	(mm)	(mm)					
804D-44-176-S40	44	176.00	271	201	70	185.5	40	50	0.50	0.50	-	GI310	GI323	1.91	HM010
804D-45-180-S40	45	180.00	275	205	70	187.5	40	55	0.50	0.50	-	GI311	GI324	2.02	HM010
804D-46-184-S40	46	184.00	279	209	70	192	40	55	0.50	0.50	-	GI311	GI324	2.12	HM010
804D-47-188-S40	47	188.00	283	213	70	196.5	40	55	0.50	0.50	-	GI311	GI324	2.22	HM010
804D-48-192-S40	48	192.00	287	217	70	201	40	55	0.50	0.50	-	GI311	GI324	2.33	HM010
804D-49-196-S40	49	196.00	291	221	70	205.5	40	55	0.30	0.50	-	GI311	GI324	2.45	HM010
804D-50-200-S40	50	200.00	295	225	70	208.5	40	58	0.15	0.50	-	GI311	GI324	2.58	HM010
804D-51-204-S40	51	204.00	299	229	70	213	40	58	0.15	0.50	-	GI311	GI324	2.68	HM010
804D-52-208-S40	52	208.00	303	233	70	217.5	40	58	0.50	0.50	-	GI312	GI325	2.64	HM010
804D-53-212-S40	53	212.00	307	237	70	222	40	58	0.50	0.50	-	GI312	GI325	2.76	HM010
804D-54-216-S40	54	216.00	311	241	70	226.5	40	58	0.50	0.50	-	GI312	GI325	2.90	HM010
804D-55-220-S40	55	220.00	315	245	70	231	40	58	0.50	0.50	-	GI312	GI325	3.00	HM010
804D-56-224-S40	56	224.00	319	249	70	235.5	40	58	0.50	0.50	-	GI312	GI325	3.15	HM010
804D-57-228-S40	57	228.00	323	253	70	240	40	58	0.35	0.50	-	GI312	GI325	3.30	HM010
804D-58-232-S40	58	232.00	327	257	70	244.5	40	58	0.15	0.50	-	GI312	GI325	3.46	HM010

GI300	XPET 0502AP	SCET 050204-UD
GI301	XPET 0602AP	SCET 050204-UD
GI302	XPET 0602AP	SCET 060204-UD
GI303	XPET 0703AP	SCET 060204-UD
GI304	XPET 0703AP	SCET 070308-UD
GI305	XPET 0903AP	SCET 070308-UD
GI306	XPET 0903AP	SCET 09T308-UD
GI307	XPET 11T3AP	SCET 09T308-UD
GI308	XPET 11T3AP	SCET 120408-UD
GI309	XPET 12T3AP	SCET 120408-UD
GI310	XPET 1504AP	SCET 120408-UD
GI311	XPET 1504AP	SCET 150512-UD
GI312	XPET 1904AP	SCET 150512-UD
GI313	XPET 0502AP-SD	SCET 050204-SD
GI314	XPET 0602AP-SD	SCET 050204-SD
GI315	XPET 0602AP-SD	SCET 060204-SD
GI316	XPET 0703AP-SD	SCET 060204-SD
GI317	XPET 0703AP-SD	SCET 070308-SD
GI318	XPET 0903AP-SD	SCET 070308-SD
GI319	XPET 0903AP-SD	SCET 09T308-SD
GI320	XPET 11T3AP-SD	SCET 09T308-SD
GI321	XPET 11T3AP-SD	SCET 120408-SD
GI322	XPET 12T3AP-SD	SCET 120408-SD
GI323	XPET 1504AP-SD	SCET 120408-SD
GI324	XPET 1504AP-SD	SCET 150512-SD
GI325	XPET 1904AP-SD	SCET 150512-SD

HM001	US 2245-T07P	0.9	US 2245-T07P	0.9	FLAG T07P
HM002	US 2205-T07P	0.9	US 2245-T07P	0.9	FLAG T07P
HM003	US 2205-T07P	0.9	US 2205-T07P	0.9	FLAG T07P
HM004	US 2506-T07P	1.2	US 2506-T07P	1.2	FLAG T07P
HM005	US 2507-T08P	1.2	US 3007-T08P	2.0	FLAG T08P
HM006	US 3007-T09P	2.0	US 3007-T09P	2.0	FLAG T09P
HM007	US 3007-T09P	2.0	US 3009-T09P	2.0	FLAG T09P
HM008	US 3510-T15P	3.0	US 3508-T15P	3.0	FLAG T15P
HM009	US 3510-T15P	3.0	US 5012-T15P	5.0	FLAG T15P
HM010	US 4011-T15P	3.5	US 5012-T15P	5.0	FLAG T15P



805D

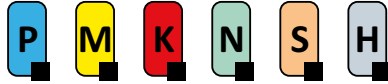

PRAMET

S



Cuerpo de Broca 805D de placa intercambiable 5XD con Refrigeración Interna

Cuerpo de broca de plaquitas intercambiables de alto rendimiento para taladrar agujeros ciegos y pasantes. Potencialmente también taladrado de agujeros cruzados, descentrados y en paquetes de chapas, interpolación helicoidal, fresado axial (plunge), taladrado en superficies cóncavas o en ángulo, taladrado con cortes interrumpidos, achaflanado y mandrinado. Disponible desde Ø19 hasta Ø31 mm en 5xD.

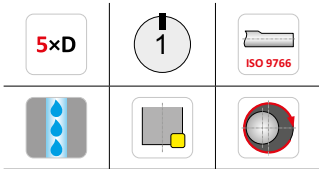
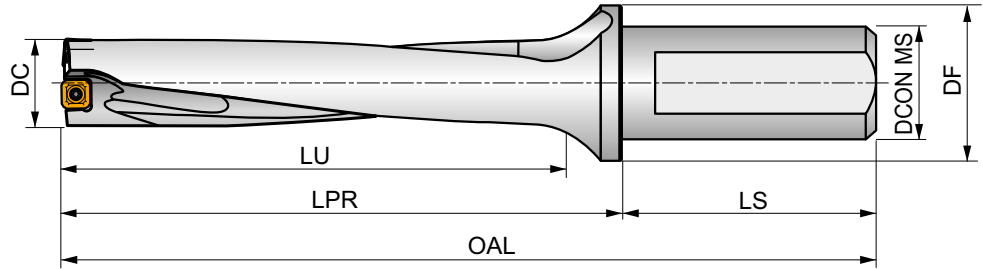

Producto	DC	APMX	OAL	LPR	LS	LU	DCON MS	DF	\bar{D}	D^+					
	(mm)	(mm)	(mm)	(mm)	(mm)	(mm)	(mm)	(mm)	(mm)	(mm)				kg	
805D-19-95-S25	19	95.00	176	120	56	100.5	25	35	0.15	0.45	–	GI301	GI314	0.38	HM002
805D-20-100-S25	20	100.00	181	125	56	105	25	35	0.10	0.45	–	GI302	GI315	0.40	HM003
805D-21-105-S25	21	105.00	186	130	56	110.5	25	35	0.10	0.50	–	GI302	GI315	0.42	HM003
805D-22-110-S25	22	110.00	191	135	56	116	25	35	0.45	0.50	–	GI303	GI316	0.45	HM004
805D-23-115-S25	23	115.00	196	140	56	121.5	25	35	0.35	0.50	–	GI304	GI317	0.48	HM005
805D-24-120-S25	24	120.00	201	145	56	127	25	35	0.15	0.50	–	GI304	GI317	0.49	HM005
805D-25-125-S32	25	125.00	210	150	60	130	32	42	0.15	0.50	–	GI304	GI317	0.72	HM005
805D-26-130-S32	26	130.00	215	155	60	135.5	32	42	0.10	0.50	–	GI304	GI317	0.75	HM005
805D-27-135-S32	27	135.00	220	160	60	141	32	42	0.50	0.30	–	GI305	GI318	0.78	HM006
805D-28-140-S32	28	140.00	225	165	60	146.5	32	42	0.30	0.50	–	GI306	GI319	0.82	HM007
805D-29-145-S32	29	145.00	230	170	60	152	32	42	0.20	0.50	–	GI306	GI319	0.86	HM007
805D-30-150-S32	30	150.00	235	175	60	157.5	32	42	0.15	0.50	–	GI306	GI319	0.90	HM007
805D-31-155-S32	31	155.00	240	180	60	163	32	42	0.15	0.50	–	GI306	GI319	0.95	HM007

GI301	XPET 0602AP	SCET 050204-UD
GI302	XPET 0602AP	SCET 060204-UD
GI303	XPET 0703AP	SCET 060204-UD
GI304	XPET 0703AP	SCET 070308-UD
GI305	XPET 0903AP	SCET 070308-UD
GI306	XPET 0903AP	SCET 09T308-UD
GI314	XPET 0602AP-SD	SCET 050204-SD
GI315	XPET 0602AP-SD	SCET 060204-SD
GI316	XPET 0703AP-SD	SCET 060204-SD
GI317	XPET 0703AP-SD	SCET 070308-SD
GI318	XPET 0903AP-SD	SCET 070308-SD



GI319

XPET 0903AP-SD

SCET 09T308-SD



HM002

US 2205-T07P

0.9

US 2245-T07P

0.9

FLAG T07P

HM003

US 2205-T07P

0.9

US 2205-T07P

0.9

FLAG T07P

HM004

US 2506-T07P

1.2

US 2506-T07P

1.2

FLAG T07P

HM005

US 2507-T08P

1.2

US 3007-T08P

2.0

FLAG T08P

HM006

US 3007-T09P

2.0

US 3007-T09P

2.0

FLAG T09P

HM007

US 3007-T09P

2.0

US 3009-T09P

2.0

FLAG T09P



EP



Casquillo de Ajuste para Brocas de Plaquita Intercambiable

Manguito para ajustar el diámetro de la broca de plaquitas intercambiables. Se puede utilizar en portaherramientas Weldon de Ø32 o Ø40 mm. El diámetro exterior de la broca se ajusta girando el manguito.

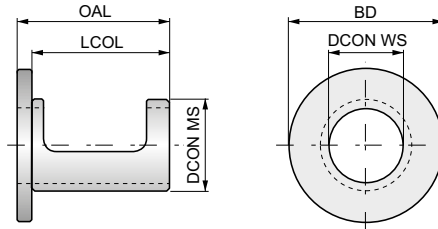

El rango de ajuste del diámetro es 0.4 – -0.2; rango de ajuste de altura central es 0.2 – -0.15.

Producto	DCON WS (mm)	DCON MS (mm)	BD (mm)	OAL (mm)	LCOL (mm)	
EP253253	25.00	32.00	53.00	53.0	48	0.15
EP324058	32.00	40.00	58.00	58.0	53	0.20



SCET



	IC (mm)	D1 (mm)	L (mm)	S (mm)
0502	5.556	2.40	5.56	2.38
0602	6.350	2.90	6.35	2.38
0703	7.937	3.50	7.94	3.18
09T3	9.525	4.50	9.53	3.97
1204	12.700	5.60	12.70	4.76
1505	15.875	5.60	15.88	5.56

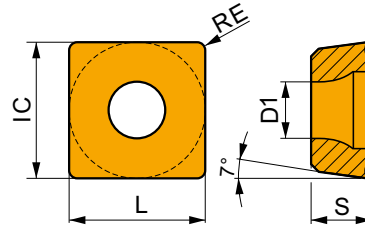

Valores de inicio adecuados para la velocidad de corte (vc), avance (f) y profundidad de corte (ap). Consulte nuestra APP Calculadora de mecanizado para obtener más cálculos.

Producto	RE (mm)	P			M			K			N			S			H		
		vc (m/min)	f (mm/rev)	ap (mm)	vc (m/min)	f (mm/rev)	ap (mm)	vc (m/min)	f (mm/rev)	ap (mm)	vc (m/min)	f (mm/rev)	ap (mm)	vc (m/min)	f (mm/rev)	ap (mm)	vc (m/min)	f (mm/rev)	ap (mm)

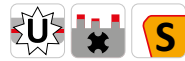
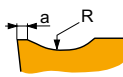

Geometría UD con diseño universal para plaquitas periféricas.

SCET 050204-UD 0,12
 SCET 060204-UD 0,15
 SCET 070308-UD 0,15
 SCET 09T308-UD 0,15
 SCET 120408-UD 0,20
 SCET 150512-UD 0,20

SCET 050204-UD	D8330	0.4	165	0.08	-	-	-	-	155	0.08	-	-	-	-	-	-	-	-	-
	D9335	0.4	240	0.08	-	-	-	-	225	0.08	-	-	-	-	-	-	-	-	-
SCET 060204-UD	D8330	0.4	165	0.11	-	-	-	-	155	0.11	-	-	-	-	-	-	-	-	-
	D9335	0.4	240	0.11	-	-	-	-	225	0.11	-	-	-	-	-	-	-	-	-
SCET 070308-UD	D8330	0.8	165	0.13	-	-	-	-	155	0.13	-	-	-	-	-	-	-	-	-
	D9335	0.8	240	0.13	-	-	-	-	225	0.13	-	-	-	-	-	-	-	-	-
SCET 09T308-UD	D8330	0.8	165	0.14	-	-	-	-	155	0.14	-	-	-	-	-	-	-	-	-
	D9335	0.8	240	0.14	-	-	-	-	225	0.14	-	-	-	-	-	-	-	-	-
SCET 120408-UD	D8330	0.8	165	0.16	-	-	-	-	155	0.16	-	-	-	-	-	-	-	-	-
	D9335	0.8	240	0.16	-	-	-	-	225	0.16	-	-	-	-	-	-	-	-	-
SCET 150512-UD	D8330	1.2	165	0.18	-	-	-	-	155	0.18	-	-	-	-	-	-	-	-	-
	D9335	1.2	240	0.18	-	-	-	-	225	0.18	-	-	-	-	-	-	-	-	-

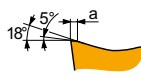

Geometría SD con diseño positivo para plaquitas periféricas.

SCET 050204-SD 0,04
 SCET 060204-SD 0,06
 SCET 070308-SD 0,08
 SCET 09T308-SD 0,10
 SCET 120408-SD 0,10
 SCET 150512-SD 0,10

SCET 050204-SD	D8330	0.4	165	0.08	-	95	0.07	-	155	0.08	-	-	-	-	40	0.06	-	-	-
	D9335	0.4	240	0.08	-	140	0.07	-	225	0.08	-	-	-	-	60	0.06	-	-	-
SCET 060204-SD	D8330	0.4	165	0.11	-	95	0.09	-	155	0.11	-	-	-	-	40	0.07	-	-	-
	D9335	0.4	240	0.11	-	140	0.09	-	225	0.11	-	-	-	-	60	0.07	-	-	-
SCET 070308-SD	D8330	0.8	165	0.13	-	95	0.11	-	155	0.13	-	-	-	-	40	0.09	-	-	-
	D9335	0.8	240	0.13	-	140	0.11	-	225	0.13	-	-	-	-	60	0.09	-	-	-
SCET 09T308-SD	D8330	0.8	165	0.14	-	95	0.13	-	155	0.14	-	-	-	-	40	0.10	-	-	-
	D9335	0.8	240	0.14	-	140	0.13	-	225	0.14	-	-	-	-	60	0.10	-	-	-
SCET 120408-SD	D8330	0.8	165	0.16	-	95	0.14	-	155	0.16	-	-	-	-	40	0.11	-	-	-
	D9335	0.8	240	0.16	-	140	0.14	-	225	0.16	-	-	-	-	60	0.11	-	-	-
SCET 150512-SD	D8330	1.2	165	0.18	-	95	0.16	-	155	0.18	-	-	-	-	40	0.12	-	-	-
	D9335	1.2	240	0.18	-	140	0.16	-	225	0.18	-	-	-	-	60	0.12	-	-	-



XPET



	IC (mm)	D1 (mm)	L (mm)	S (mm)
0502	5.556	2.40	5.56	2.38
0602	6.350	2.60	6.35	2.38
0703	7.937	2.90	7.94	3.18
0903	9.525	3.50	9.53	3.18
11T3	11.509	3.90	11.50	3.97
12T3	12.700	3.90	12.70	3.97
1504	15.875	4.50	15.88	4.76
1904	19.050	4.50	19.05	4.76

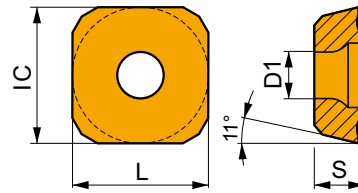

Valores de inicio adecuados para la velocidad de corte (vc), avance (f) y profundidad de corte (ap). Consulte nuestra APP Calculadora de mecanizado para obtener más cálculos.

Producto	RE (mm)	P			M			K			N			S			H		
		vc (m/min)	f (mm/rev)	ap (mm)	vc (m/min)	f (mm/rev)	ap (mm)	vc (m/min)	f (mm/rev)	ap (mm)	vc (m/min)	f (mm/rev)	ap (mm)	vc (m/min)	f (mm/rev)	ap (mm)	vc (m/min)	f (mm/rev)	ap (mm)

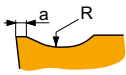

Geometría de diseño universal para plaquitas centrales.

XPET 0502AP	0,10
XPET 0602AP	0,10
XPET 0703AP	0,15
XPET 0903AP	0,25
XPET 11T3AP	0,25
XPET 12T3AP	0,25
XPET 1504AP	0,25
XPET 1904AP	0,25

XPET 0502AP	D8345	—	■	165	0.08	—	—	—	—	■	155	0.08	—	—	—	—	—	—	—
XPET 0602AP	D8345	—	■	165	0.11	—	—	—	—	■	155	0.11	—	—	—	—	—	—	—
XPET 0703AP	D8345	—	■	165	0.13	—	—	—	—	■	155	0.13	—	—	—	—	—	—	—
XPET 0903AP	D8345	—	■	165	0.14	—	—	—	—	■	155	0.14	—	—	—	—	—	—	—
XPET 11T3AP	D8345	—	■	165	0.16	—	—	—	—	■	155	0.16	—	—	—	—	—	—	—
XPET 12T3AP	D8345	—	■	165	0.16	—	—	—	—	■	155	0.16	—	—	—	—	—	—	—
XPET 1504AP	D8345	—	■	165	0.18	—	—	—	—	■	155	0.18	—	—	—	—	—	—	—
XPET 1904AP	D8345	—	■	165	0.18	—	—	—	—	■	155	0.18	—	—	—	—	—	—	—

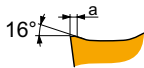

Geometría SD con diseño positivo para plaquitas centrales.

XPET 0502AP-SD	0,04
XPET 0602AP-SD	0,05
XPET 0703AP-SD	0,08
XPET 0903AP-SD	0,10
XPET 11T3AP-SD	0,10
XPET 12T3AP-SD	0,10
XPET 1504AP-SD	0,10
XPET 1904AP-SD	0,12

XPET 0502AP-SD	D8345	—	■	165	0.08	—	■	95	0.07	—	■	155	0.08	—	—	—	■	40	0.06	—	—	—	—
XPET 0602AP-SD	D8345	—	■	165	0.11	—	■	95	0.09	—	■	155	0.11	—	—	—	■	40	0.07	—	—	—	—
XPET 0703AP-SD	D8345	—	■	165	0.13	—	■	95	0.11	—	■	155	0.13	—	—	—	■	40	0.09	—	—	—	—
XPET 0903AP-SD	D8345	—	■	165	0.14	—	■	95	0.13	—	■	155	0.14	—	—	—	■	40	0.10	—	—	—	—
XPET 11T3AP-SD	D8345	—	■	165	0.16	—	■	95	0.14	—	■	155	0.16	—	—	—	■	40	0.11	—	—	—	—
XPET 12T3AP-SD	D8345	—	■	165	0.16	—	■	95	0.14	—	■	155	0.16	—	—	—	■	40	0.11	—	—	—	—
XPET 1504AP-SD	D8345	—	■	165	0.18	—	■	95	0.16	—	■	155	0.18	—	—	—	■	40	0.12	—	—	—	—
XPET 1904AP-SD	D8345	—	■	165	0.18	—	■	95	0.16	—	■	155	0.18	—	—	—	■	40	0.12	—	—	—	—



WCMT-ID

	IC	D1	L	S
	(mm)	(mm)	(mm)	(mm)
0402	6.350	2.90	4.30	2.38
0503	7.938	3.50	5.40	3.18
06T3	9.525	4.40	6.50	3.97
0804	12.700	5.50	8.70	4.76

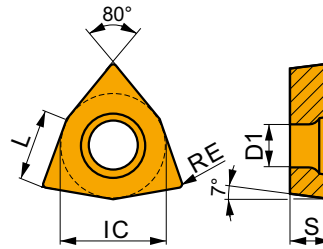

Valores de inicio adecuados para la velocidad de corte (vc), avance (f) y profundidad de corte (ap). Consulte nuestra APP Calculadora de mecanizado para obtener más cálculos.

Producto	RE	P			M			K			N			S			H		
		vc	f	ap	vc	f	ap	vc	f	ap	vc	f	ap	vc	f	ap	vc	f	ap
	(mm)	(m/min)	(mm/rev)	(mm)	(m/min)	(mm/rev)	(mm)	(m/min)	(mm/rev)	(mm)	(m/min)	(mm/rev)	(mm)	(m/min)	(mm/rev)	(mm)	(m/min)	(mm/rev)	(mm)
 Geometría 45 para mecanizado en acabado a desbaste y cortes continuos a interrumpidos.	D8330	0.8	165	0.15	95	0.14	155	0.15	-	-	-	-	-	-	-	-	-	-	-
 Geometría 46 para mecanizado fino a acabado y cortes continuos a interrumpidos.	D8330	0.8	165	0.15	95	0.14	155	0.15	-	-	-	-	-	-	-	-	-	-	-
 Geometría 47 para mecanizado en acabado a semidesbaste y cortes continuos a interrumpidos.	D8330	0.8	165	0.15	95	0.14	155	0.15	-	-	-	-	-	-	-	-	-	-	-
 Geometría 48 para mecanizado en acabado a semidesbaste y cortes continuos a interrumpidos.	D8330	0.8	165	0.20	95	0.18	155	0.20	-	-	-	-	-	-	-	-	-	-	-
 Geometría UM para mecanizado en acabado a semidesbaste y cortes continuos a ligeramente interrumpidos.	D8330	1.2	165	0.22	95	0.22	155	0.22	-	-	-	-	-	-	-	-	-	-	-
WCMT 040208E-UM	D8330	0.8	165	0.20	95	0.18	155	0.20	-	-	-	-	-	-	-	-	-	-	-
WCMT 050308E-UM	D8330	0.8	165	0.20	95	0.18	155	0.20	-	-	-	-	-	-	-	-	-	-	-



WCMX



	IC	D1	L	S
	(mm)	(mm)	(mm)	(mm)
0302	5.556	2.85	3.80	2.38
0402	6.350	3.15	4.30	2.38
0503	7.938	3.20	5.40	3.18
06T3	9.525	3.72	6.50	3.97
0804	12.700	4.30	8.70	4.76

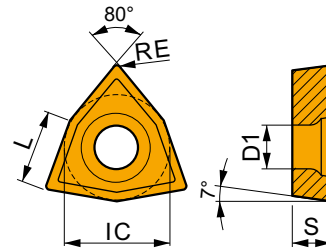

Valores de inicio adecuados para la velocidad de corte (vc), avance (f) y profundidad de corte (ap). Consulte nuestra APP Calculadora de mecanizado para obtener más cálculos.

Producto	RE (mm)	P			M			K			N			S			H						
		vc (m/min)	f (mm/rev)	ap (mm)	vc (m/min)	f (mm/rev)	ap (mm)	vc (m/min)	f (mm/rev)	ap (mm)	vc (m/min)	f (mm/rev)	ap (mm)	vc (m/min)	f (mm/rev)	ap (mm)	vc (m/min)	f (mm/rev)	ap (mm)				
		U		S		Geometría 45 para mecanizado en acabado a desbaste y cortes continuos a interrumpidos.																	
WCMX 06T308E-45	D8330 0.8	165	0.15	—	95	0.14	—	155	0.15	—	—	—	—	—	—	—	—	—	—				
		U		S		Geometría 46 para mecanizado fino a acabado y cortes continuos a interrumpidos.																	
WCMX 030208E-46	D8330 0.8	165	0.15	—	95	0.14	—	155	0.15	—	—	—	—	—	—	—	—	—	—				
WCMX 040208E-46	D8330 0.8	165	0.15	—	95	0.14	—	155	0.15	—	—	—	—	—	—	—	—	—	—				
		U		S		Geometría 47 para mecanizado en acabado a semidesbaste y cortes continuos a interrumpidos.																	
WCMX 050308E-47	D8330 0.8	165	0.20	—	95	0.18	—	155	0.20	—	—	—	—	—	—	—	—	—	—				
		U		S		Geometría 48 para mecanizado en acabado a semidesbaste y cortes continuos a interrumpidos.																	
WCMX 080412E-48	D8330 1.2	165	0.22	—	95	0.20	—	155	0.22	—	—	—	—	—	—	—	—	—	—				



**TALADRADO
INFORMACIÓN TÉCNICA**



GRUPOS DE MATERIALES (WMG)

ISO Para seleccionar una calidad y geometría de corte para una amplia gama de materiales a mecanizar

Definición general

P. ej., acero, acero inoxidable, etc.

P **M** **K** **N** **S** **H**

Subgrupo

Para navegar y seleccionar la herramienta idónea para una gama más específica de materiales a mecanizar

Definición por estructura/composición

P. ej., acero al carbono, acero aleado, etc.

P **M** **K** **N** **S** **H**

P1

P2

P3

P4

WMG

Para seleccionar y proporcionar condiciones de corte dentro de un rango de $\pm 10\%$

Definición por dureza/resistencia a la tracción

P. ej., $160 < 220$ HB, $620 < 900$ N/mm² ...

P

P1 **P1.1** **P1.2** **P1.3**

P2 **P2.1** **P2.2** **P2.3**

P3 **P3.1** **P3.2** **P3.3**

P4 **P4.1** **P4.2** **P4.3**

SOBRE LA CLASIFICACIÓN DE MATERIALES EN DORMER PRAMET

Los grupos de materiales («WMG») se utilizan para seleccionar de forma sencilla y fiable la herramienta de corte adecuada y los valores iniciales apropiados para las condiciones de mecanizado de aplicaciones específicas.

Dormer Pramet clasifica los materiales a mecanizar en seis grupos de diferentes colores:

- **Azul:** acero y acero fundido (grupo P);
- **Amarillo:** acero inoxidable (grupo M);
- **Rojo:** fundición (grupo K);
- **Verde:** materiales no férricos (grupo N);
- **Marrón:** aleaciones termoresistentes (grupo S);
- **Gris:** materiales endurecidos (grupo H).

Cada uno de estos grupos se divide, a su vez, en subgrupos según su estructura o composición. Por ejemplo, el grupo P de acero y acero fundido se desglosa en cuatro subgrupos:

- **P1 – Acero de fácil mecanizado**
- **P2 – Acero al carbono**
- **P3 – Acero aleado**
- **P4 – Acero para herramientas**

Finalmente, se realiza una última división en función de las propiedades del material, como la dureza y la resistencia a la tracción. Esta clasificación se lleva a cabo para ofrecer a nuestros clientes un asesoramiento completo sobre la herramienta y los valores iniciales de velocidad de corte y avance.

La tabla que se muestra en la página siguiente incluye una descripción de cada grupo de materiales a mecanizar, así como ejemplos de designaciones de uso común.



GRUPOS DE MATERIALES (WMG)

Grupo ISO	Subgrupo	WMG (Work Material Group/grupo de material de la pieza)	k_{wg}	Ejemplos de material (AISI, EN, DIN, ČSN, GB, SS, STN, BS, UNE, AFNOR, ASTM, GOST, UNS, UNI, etc.)	
P Acero y acero fundido (aceros con un contenido de aleación ≤10% y una dureza <45 HRC)	P1 Acero de fácil mecanizado (aceros al carbono con maquinabilidad aumentada)	P1.1 Acero al carbono sulfurado de mecanizado libre con una dureza <240 HB	1.33	AISI 1108, EN 15522, DIN 1.0723, SS 1922, ČSN 11120, BS 210A15, UNE F.210F, GB Y15, AFNOR 10F1, GOST A30, UNI CF10S20	
		P1.2 Acero al carbono sulfurado y fosforizado de mecanizado libre con una dureza <180 HB	1.49	AISI 1211, EN 115Mn30, DIN 1.0715, SS 1912, ČSN 11109, BS 230M7, UNE F.2111, GB Y15, AFNOR S250, GOST A40G, UNI CF9SMn28	
		P1.3 Acero al carbono sulfurado/fosforizado y con plomo de mecanizado libre con una dureza <180 HB	1.53	AISI 12L13, EN 115MnPb30, DIN 1.0718, SS 1914, ČSN 12110, BS 210M16, UNE F.2114, GB Y15Pb, AFNOR S250Pb, GOST A35G2, UNI CF10SPb20	
	P2 Acero al carbono (aceros compuestos principalmente por hierro y carbono)	P2.1 Acero de bajo contenido en carbono con <0,25% C y una dureza <180 HB		1.14	AISI 1015, EN C15, DIN 1.0401, SS 1350, ČSN 11301, BS 080A15, UNE F.111, GB 15, AFNOR C18RR, GOST S22ps, UNI Fe360
		P2.2 Acero con contenido medio de carbono <0,55% C y una dureza <240 HB		1.00	AISI 1030, EN C30, DIN 1.0528, SS 1550, ČSN 12031, BS 080M32, UNE F.1130, GB 30, AFNOR AF50C30, GOST 30G, UNI Fe590
		P2.3 Acero de alto contenido en carbono con >0,55% C y una dureza de <300 HB		0.89	AISI 1060, EN C60, DIN 1.0601, SS 1655, ČSN 12061, BS 080A62, UNE F.513, GB 60, AFNOR 1C60, GOST 60G, UNI C60
	P3 Acero aleado (aceros al carbono con un contenido de aleación ≤10%)	P3.1 Acero aleado con una dureza <180 HB		0.92	AISI 5015, EN 16Mo3, DIN 1.5415, SS 2912, ČSN 15020, BS 1501-240, UNE F.2601, GB 16Mo, AFNOR 15D3, GOST 15M, UNI 16Mo3KW
		P3.2 Acero aleado con una dureza de 180-260 HB		0.74	AISI 4140, EN 42CrMo4, DIN 1.7225, SS 2244, ČSN 15142, BS 708M40, UNE F.8232, GB 42CrMo, AFNOR 42CD4, GOST 40CHFA, UNI 42CrMo4
		P3.3 Acero aleado con una dureza de 260-360 HB		0.63	AISI 4140, EN 42CrMo4, DIN 1.7225, SS 2244, ČSN 15142, BS 708M40, UNE F.8232, GB 42CrMo, AFNOR 42CD4, GOST 40CHFA, UNI 42CrMo4
	P4 Acero para herramientas (acero de aleación especial para herramientas, matrices y moldes)	P4.1 Acero para herramientas con una dureza <26 HRC		0.55	AISI D2, EN X155CrVMo12-1, DIN 1.2370, SS 2736, ČSN 19573, BS BD2, UNE F.520A, GB Cr12Mo1V1, AFNOR Z160CDV12, GOST Ch12MF, UNI X155CrVMo121KU
		P4.2 Acero para herramientas con una dureza de 26-39 HRC		0.47	AISI D2, EN X155CrVMo12-1, DIN 1.2370, SS 2736, ČSN 19573, BS BD2, UNE F.520A, GB Cr12Mo1V1, AFNOR Z160CDV12, GOST Ch12MF, UNI X155CrVMo121KU
		P4.3 Acero para herramientas con una dureza de 39-45 HRC		0.38	AISI D2, EN X155CrVMo12-1, DIN 1.2370, SS 2736, ČSN 19573, BS BD2, UNE F.520A, GB Cr12Mo1V1, AFNOR Z160CDV12, GOST Ch12MF, UNI X155CrVMo121KU



GRUPOS DE MATERIALES (WMG)

Grupo ISO	Subgrupo	WMG (Work Material Group/grupo de material de la pieza)	k _{vg}	Ejemplos de material (AISI, EN, DIN, ČSN, GB, SS, STN, BS, UNE, AFNOR, ASTM, GOST, UNS, UNI, etc.)
M Acero inoxidable (aceros resistentes a la corrosión con un contenido de cromo ≥11 %)	M1 Acero inoxidable ferrítico (aleaciones rectas de cromo no endurecibles)	M1.1 Acero inoxidable ferrítico con una dureza <160 HB	1.22	AISI 5429, EN X7Cr14, DIN 1.4001, SS 2326, BS 434517, UNE F.3401, AFNOR Z8C12, GOST 08Ch13, UNI X6CrTi12
		M1.2 Acero inoxidable ferrítico con una dureza de 160-220 HB	1.03	AISI 446, EN X10CrAl24, DIN 1.4762, SS 2322, ČSN 17113, BS 430517, UNE F.3154, GB 10Cr17, AFNOR Z10CA524, GOST 12Ch17, UNI X16Cr26
	M2 Acero inoxidable martensítico (aleaciones rectas de cromo no endurecibles)	M2.1 Acero inoxidable martensítico con una dureza <200 HB	1.08	AISI 430F, EN X14CrMo517, DIN 1.4104, SS 2383, ČSN 17140, BS 410521, UNE F.3117, AFNOR Z10CF17, UNI X10Cr517
		M2.2 Acero inoxidable martensítico con una dureza de 200-280 HB	0.89	AISI 440C, EN X105CrMo17, DIN 1.4125, SS 2385, ČSN 17023, BS 425C11, UNE F.3402, GB 102Cr17Mo, AFNOR Z100CD17, GOST 95Ch18, UNI GX6CrNi 13 04
	M3 Acero inoxidable austenítico (aleaciones de cromo-níquel y cromo-níquel-manganeso)	M3.1 Acero inoxidable austenítico con una dureza <200 HB	0.75	AISI 420, EN X45Cr13, DIN 1.4034, ČSN 17029, BS 425C11, UNE F.3405, AFNOR Z44C14, GOST 20X17H12, UNI X30Cr13
		M3.2 Acero inoxidable austenítico con una dureza de 280-380 HB	1.00	AISI 304, EN X5CrNi18-12, DIN 1.4303, SS 2352, ČSN 17249, BS 305517, UNE F.3513, GB 10Cr18Ni12, AFNOR Z8CN18.12, UNI X7CrNi18 10
	M4 Acero inoxidable superaustenítico, duplex o templado por precipitación (aleaciones austeníticas con > 20 % Ni, microestructura austenítica-ferrítica o templado por precipitación)	M3.3 Acero inoxidable austenítico con una dureza de 260-300 HB	0.86	AISI 309, EN X15CrNiSi20-12, DIN 1.4828, ČSN 17251, BS 309S24, UNE F.3312, GB 1G23Ni13, AFNOR Z15CNS20.12, GOST 20Ch20Ni452, UNI 16CrNi23 14
		M4.1 Acero inoxidable superaustenítico/ferrítico o superaustenítico con una dureza <300 HB	0.77	AISI 5848, EN X45CrNiW18-9, DIN 1.4873, BS 331540, UNE F.3211, AFNOR Z35CNW514-4, UNI X45CrNiW 18 9
		M4.2 Acero inoxidable austenítico, templado por precipitación y una dureza de 300-380 HB	0.75	AISI 329, EN X1-NiCrMoCu25-20-5, DIN 1.4539, SS 2562, ČSN 17265, BS 318513, UNE F.3552, GB 022Cr25NiMo2N, AFNOR Z1NCUD25.20
			0.64	AISI 631 (17-7PH), EN X7CrNiAl17-7, DIN 1.4568, SS 2388, ČSN 17465, BS 301513, UNE F.3217, GB 07Cr17Ni7Al, AFNOR Z9CNAl17-07, GOST 09Ch17N7Jut, UNI X53CrMnNiN21 9



GRUPOS DE MATERIALES (WMG)

Grupo ISO	Subgrupo	WMG (Work Material Group/grupo de material de la pieza)	k_{wc}	Ejemplos de material (AISI, EN, DIN, ČSN, GB, SS, STN, BS, UNE, AFNOR, ASTM, GOST, UNS, UNI, etc.)
K Fundición (piezas de fundición y aleaciones al carbono con un contenido de carbono >2%)	K1 Fundición gris (GG) (fundiciones de hierro y carbono con microestructura de grafito laminar)	K1.1 Fundición gris ferrítica o ferrítica/perlítica con una dureza <180 HB	1.35	ASTM A48 Grade 20 (F11401), EN-JL-100, DIN GG-10 (0.6010), SS 0110, STN 422410, BS Grade 150, UNE FG10, GB HAT 100, AFNOR Fc10D, GOST SC 10, UNI G10
		K1.2 Fundición gris ferrítica/perlítica o perlítica con una dureza de 180-240 HB	1.00	ASTM A48 Grade 30 (F12101), EN-JL-1030, DIN GG-20 (0.6020), SS 0120, STN 422420, BS Grade 220, UNE FG20, GB HT200, AFNOR Ft20D, GOST Ч420, UNI G20
		K1.3 Fundición gris perlítica con una dureza de 240-280 HB	0.75	ASTM A48 Grade 50 (F13501), EN-JL-1060, DIN GG-35 (0.6035), SS 0135, STN 422435, BS Grade 350, UNE FG35, GB HAT300, AFNOR Fc35D, GOST SC35, UNI G35
	K2 Fundición maleable (GTS/GTW) (fundiciones de hierro y carbono tratadas térmicamente con una microestructura sin grafito)	K2.1 Fundición maleable ferrítica con una dureza <160 HB	1.39	ASTM A602 Grade M3210 (F20000), EN-JM-1130, DIN GTS-35 (0.8135), SS 0815, BS B340/12, UNE Type A, AFNOR MN 35-10, GOST K435-10
		K2.2 Fundición maleable, ferrítica o perlítica, con una dureza de 160-200 HB	1.13	ASTM A602 Grade M4504 (F20001), EN-JM-1040, DIN GTS-50-05 (0.8045), BS P50-05, AFNOR MB 45-7
		K2.3 Fundición maleable perlítica con una dureza de 200-240 HB	0.90	ASTM A602 Grade M7002 (F20004), EN-JM-1140, DIN GTS-45 (0.8145), SS 0854, STN 422540, BS P 45-06, UNE Typ B, AFNOR MP 50-5, GOST K445-7, UNI GMN 45
	K3 Fundición dúctil (GGG) (fundiciones de hierro y carbono con microestructura de grafito nodular)	K3.1 Fundición dúctil (nodular/esferoidal) ferrítica con una dureza <180 HB	1.23	ASTM A536 Grade 60-40-18 (F32800), EN-JS-1030, DIN GGG-40 (0.7040), SS 0717, STN 422304, BS 420/12, UNE FGE 42-12, GB QT 400, AFNOR FGS 400-12, GOST B440
		K3.2 Fundición dúctil (nodular/esferoidal), ferrítica o perlítica, con una dureza de 180-220 HB	0.94	ASTM A536 Grade 80-55-06 (F33800), EN-JS-1050, DIN GGG-50 (0.7050), SS 0727, STN 422305, BS 500/7, UNE FGE 50-7, GB QT 500-7, AFNOR FGS 500-7, GOST B450
		K3.3 Fundición dúctil (nodular/esferoidal) perlítica con una dureza de 220-260 HB	0.76	ASTM A536 Grade 100-70-03 (F34800), EN-JS-1060, DIN GGG-60 (0.7060), SS 0732, STN 422306, BS 600/3, UNE FG70-2, GB QT 600-3, AFNOR FGS 600-3, GOST B460
	K4 Fundición dúctil austenítica o austemperada (Ni-Resist/ADI) (fundiciones de aleaciones de hierro y carbono con una microestructura austenítica o ausferrita)	K4.1 Fundición austenítica con una dureza <180 HB	1.14	ASTM A436 Type 1 (L-NiCuCr 15 6 2, F41000), EN-JL-3011, DIN GGL-NiMn 13 7 (0.6652), SS 0523, BS Grade F1, AFNOR FGL-Ni13Mn7, GOST S-NiMn 13 7
		K4.2 Fundición austenítica con una dureza de 180-240 HB	0.86	ASTM A439 Type D-2B (S-NiCr 20 3, F43001), EN-JS-3021, DIN GGG-NiMn 23 4, SS 0776, BS Grade S2M, AFNOR FGS Ni23 Mn4, GOST ЧH19X3U
		K4.3 Fundición dúctil austemperada con una dureza de 240-280 HB	0.63	ASTM A897 Grade 110-70-11
	K5 Fundición de grafito compactado (CGI) (fundiciones de hierro y carbono con estructura de grafito vermicular)	K4.4 Fundición dúctil austemperada con una dureza de 280-320 HB	0.54	ASTM A897 Grade 125-80-10, EN-JS-1100, DIN GGG-90 (5.3400)
		K4.5 Fundición dúctil austemperada con una dureza de 320-360 HB	0.45	ASTM A897 Grade 2 (150-110-07), EN-JS-1110, DIN GGG-100 (5.3403)
		K5.1 Fundición de grafito compactado vermicular con una dureza <180 HB	1.29	ASTM A842 Grade 300, EN-GJV-300, DIN GGV 30, GOST ЧBT30,
K5	K5.2 Fundición de grafito compactado vermicular con una dureza de 180-220 HB	0.97	ASTM A842 Grade 350, EN-GJV-350, DIN GGV 35 (5.2200), GOST ЧBT30,	
	K5.3 Fundición de grafito compactado vermicular con una dureza de 220-260 HB	0.75	ASTM A842 Grade 450, EN-GJV-450, DIN GGV 45, GOST ЧBT45,	



GRUPOS DE MATERIALES (WMG)

Grupo ISO	Subgrupo	WMG (Work Material Group/grupo de material de la pieza)	k _{vg}	Ejemplos de material (AISI, EN, DIN, ČSN, GB, SS, STN, BS, UNE, AFNOR, ASTM, GOST, UNS, UNI, etc.)
N Materiales no ferreos (metales, incluidas las aleaciones sin una cantidad apreciable de hierro y otros materiales no metálicos)	N1 Aluminio forjado	N1.1 Aluminio puro y aleaciones forjadas de aluminio con una dureza <60 HB	1.33	UNS A91200, EN AL99.6, DIN 3.0205, SS 4010, STN 424009, BS 1C, UNE L-3001, GB L5, AFNOR A4, GOST A1C, UNI 3567
		N1.2 Aleaciones forjadas de aluminio con una dureza de 60-100 HB	1.00	UNS A93004, EN AIMn0.5Mg0.5, DIN 3.0505, SS 4054, STN 424432, BS N31, UNE L-3831, GB LF2, AFNOR A-M1, GOST AM14, UNI 3568
		N1.3 Aleaciones forjadas de aluminio con una dureza de 100-150 HB	0.67	UNS A95083, EN AIMg4.5Mn0.7, DIN 3.3547, SS 4140, STN 424415, BS N8, UNE L-3321, GB AIMg4.5Mn, AFNOR A-G4.5Mn, GOST Amg 4.5, UNI P-AIMg4.4
	N2 Aluminio fundido	N2.1 Aleaciones de aluminio fundido con una dureza <75 HB	0.67	UNS A02080, EN AICu45, BS LM11, STN 424331, UNE AISi1Cu, GOST AMg5K, UNI G-AISi7Mg
		N2.2 Aleaciones de aluminio fundido con una dureza de 75-90 HB	0.60	UNS A02420, EN AICu4Ni2Mg2, SS AISi7MgFe, BS LM6, STN 424519, UNE AI-7SiMg, AFNOR A-S7G, GOST AK7, UNI G-AISi7Mg
		N2.3 Aleaciones de aluminio fundido con una dureza de 90 < 140 HB	0.43	UNS A03360, EN G-ALCu4NiMg2, SS AISi10Mg, STN 424336, BS LM 30, AFNOR A-S10G, UNI G-AISi9Mg
	N3 Cobre o aleaciones de cobre	N3.1 Aleaciones de cobre con excelentes propiedades de mecanizado	0.70	UNS C14700, EN CuPb1P, DIN 2.1498, STN 423214, BS C111, AFNOR CuZn35Pb2, GOST L63-3, UNI CuS(P0.01)
		N3.2 Aleaciones de cobre de viruta corta con propiedades de mecanizado de óptimas a moderadas	0.41	UNS C81540, EN CuNi25iCr, DIN 2.0857, STN 423220, BS NS113, UNE CuSn12, AFNOR CuZn40, GOST L60, UNI P-CuZn-40
		N3.3 Cobre electrolítico y aleaciones de cobre de viruta larga con propiedades de mecanizado de moderadas a limitadas	0.21	UNS C10100, EN CuAg0.1, DIN 2.1203, SS 5010, UNE CUSi3Mn1, AFNOR Cu-C2, GOST M1f, UNI Cu-OF
	N4 Polímeros (materiales sintéticos o semisintéticos)	N4.1 Polímeros termoplásticos	0.70	ABS, Acryl, Duraplast, Elastomer, EP, Epoxid, FEP, Fluor, Gummi, Kautschuk, Latex, ME, MPF, PA, PAI, PC, PE, PEEK, PEI, PES, PET, PF, Phenolharze, PI, PMMA, Polyamide, Polyester, Polyolefine, Polysulfon, POM, PP, PPE, PPS, PS, PSU, PTFE, PU, PUR, PVDF, SAN, SI, Styrol, UF, Ureol
		N4.2 Polímeros termoesestables	0.27	Aramid, Epoxy, Fluoropolymer, Meacrylate, Melamine, Phenolic, Polyester, Polyimide, Polymethacrylimide, Polyurethane
		N4.3 Composites o polímeros reforzados	0.29	CFK, GFK, GMT, Honeycomb, Kevlar, LFT, Organo, SMC
	N5 Grafito	N5.1	1.0	CGM-1, CM-00, GM-10, GM-11, GR030, GR030PI, GR060, GR060PI, GR125, MC-01, MC-01R0, MC-03, MC-03M, IG11, IG-15, IG-32, IG-43, IG-45, IG-70, ISEM-1, ISEM-2, ISEM-3, R8340, R8500X, Technograph 15, Technograph 30, ISO-63, EDM C-3, EDM1, EDM3, ISO-90, ISO-93, ISO-95, R8510, R8650, R8650



GRUPOS DE MATERIALES (WMG)

Grupo ISO	Subgrupo	WMG (Work Material Group/grupo de material de la pieza)	$k_{w,c}$	Ejemplos de material (AISI, EN, DIN, ČSN, GB, SS, STN, BS, UNE, AFNOR, ASTM, GOST, UNS, UNI, etc.)
S Aleaciones termorresistentes (superalaciones con una alta resistencia a la temperatura y a la corrosión, superior a la del acero inoxidable)	S1 Titanio o aleaciones de titanio	S1.1 Titanio o aleaciones de titanio con una dureza <200 HB	1.94	UNS R50250 (Grade 1), EN Ti 99.6, DIN 3.7035, BS TA.2, UNE Ti-Po2, AFNOR T-40, GOST BT1-00, AISI R50250, 3.7025, T35, 2TA1, R50400, 3.7035, 2TAZ,
		S1.2 Aleaciones de titanio con una dureza de 200-280 HB	1.72	UNS R56404 (Grade 29), EN Ti2Cu, DIN 3.7124, BS TA.21, UNE Ti-P11, AFNOR T-U2, AISI TA6V, Ti-6Al-4V, Ti 10.2.3, Ti5553
		S1.3 Aleaciones de titanio con una dureza de 280-360 HB	1.44	UNS R54250 (Grade 38), EN TiAl6V4, DIN 3.7165, ČSN TiAl6VELI, BS TA. 13, UNE Ti-P63, AFNOR T-A6V, GOST BT6, AISI TA6V, Ti-6Al-4V, Ti 10.2.3, Ti5553
	S2 Aleaciones termorresistentes con base Fe	S2.1 Aleaciones termorresistentes con base Fe con una dureza <200 HB	1.33	UNS N08801 (Incoloy 801), EN X8 NiCrAlTi31-21, DIN 1.4959, BS NA 15, AFNOR Z8NC33-21, AISI A-286, Discaloy, Haynes 556, Inconel 909, Greek Ascology
		S2.2 Aleaciones termorresistentes con base Fe con una dureza de 200-280 HB	1.17	UNS N19907, EN X6NiCrTiMoVB25-15-2, DIN 1.4980, SS 2570, BS HR52, AFNOR Z6NCTDV25.15B, GOST 36HXT10, AISI A-286, Discaloy, Haynes 556, Inconel 909, Greek Ascology
	S3 Aleaciones termorresistentes con base Ni	S3.1 Aleaciones termorresistentes con base Ni con una dureza <280 HB	1.00	UNS A09706 (Inconel 706), EN NiCr25FeAl, DIN 2.4856, BS HR 6, ČSN Inconel 625, UNE F.3313, GB 1Cr16Ni35, AFNOR NC22FeDNB, GOST XH38BT, AISI Inconel 718, 706 Waspalloy, Udimet 720, Inconel 625
		S3.2 Aleaciones termorresistentes con base Ni con una dureza de 280-360 HB	0.83	UNS N07001, EN NiCr20Co13Mo4Ti3Al, DIN 2.4654, BS HR 2, ČSN Waspalloy, AFNOR NCKD 20ATV, GOST XH80T5K0, AISI Inconel 718, 706 Waspalloy, Udimet 720, Inconel 625
	S4 Aleaciones termorresistentes con base Co	S4.1 Aleaciones termorresistentes con base Co con una dureza <240 HB	0.78	UNS R30016 (Stellite 6b), EN CoCr20W15Ni, DIN 2.4964, AFNOR KC 20 WN, GOST ЛК52, AISI Haynes 25, Stellite 21, 31
		S4.2 Aleaciones termorresistentes con base Co con una dureza de 240-320 HB	0.67	UNS R30016 (Stellite 6b), EN CoCr20W15Ni, DIN 2.4964, AFNOR KC 20 WN, GOST ЛК52, AISI Haynes 25, Stellite 21, 31



GRUPOS DE MATERIALES (WMG)

Grupo ISO	Subgrupo	WMG (Work Material Group/grupo de material de la pieza)	k_{vg}	Ejemplos de material (AISI, EN, DIN, ČSN, GB, SS, STN, BS, UNE, AFNOR, ASTM, GOST, UNS, UNI, etc.)
H Materiales endurecidos (cualquier metal técnico con una dureza >45 HRC)	H1 Fundición en frío	H1.1 Fundición en frío con una dureza <440 HB	1.52	UNS F45001, EN-GJS-1050-6, DIN 5.3406, SS 0512, BS Grade 2A
		H2.1 Fundición endurecida con una dureza <55 HRC	0.90	UNS F45003, EN-GJS-1400-1, DIN 5.3405, SS 0457, BS Grade 3D
	H2 Fundición endurecida	H2.2 Fundición endurecida con una dureza >55 HRC	0.77	UNS F45003, EN G-X260NiCr4-2, DIN 0.9620, SS 0466, BS Grade S
		H3.1 Acero endurecido con una dureza <51 HRC	1.00	AISI 4135, EN 34CrMo4, DIN 1.7220, SS 2234, STN 415131, BS 198, UNE F.1250, GB 35CrMo, AFNOR 35CD4, GOST AC38XTM, UNI 35CrMo4KB
	H3 Acero endurecido <55 HRC	H3.2 Acero endurecido con una dureza de 51-55 HRC	0.82	AISI 4135, EN 34CrMo4, DIN 1.7220, SS 2234, STN 415131, BS 198, UNE F.1250, GB 35CrMo, AFNOR 35CD4, GOST AC38XTM, UNI 35CrMo4KB
		H4 Acero endurecido >55 HRC	H4.1 Acero endurecido con una dureza de 55-59 HRC	0.64
	H4.2 Acero endurecido con una dureza >59 HRC		0.54	UNS T31501, EN 100MnCrW4, DIN 1.2510, SS 2140, STN 419413, BS B01, UNE F.5220, GB 9CrWMn, AFNOR 90MnWCrV5, GOST 9XBТ, UNI 95MnWCr5KU

GEOMETRÍA DE PLAQUITAS

45

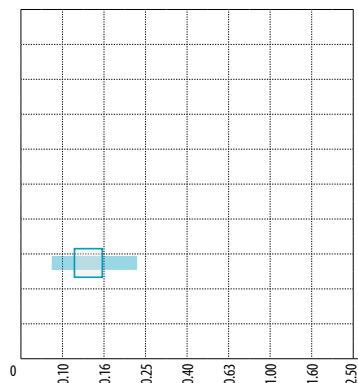
P	M	K	N	S	H
■	▣	■	■	■	■

Consultar diagrama

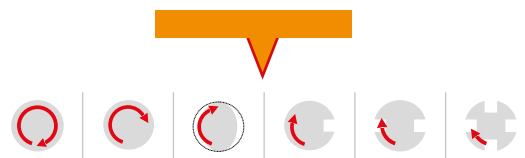

? WCMT 06, WCMX 06

46

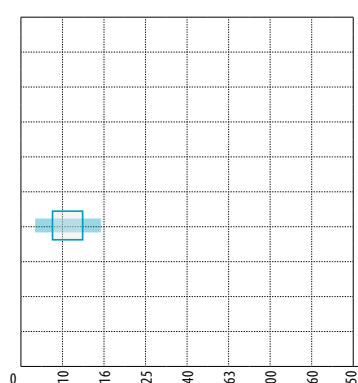
P	M	K	N	S	H
■	▣	■	■	■	■

Consultar diagrama

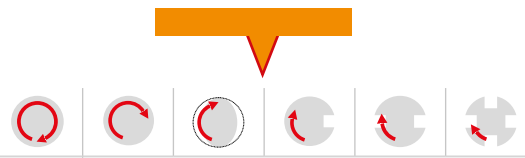

? WCMT 04, WCMX 03, WCMX 04

47

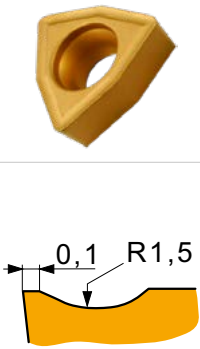
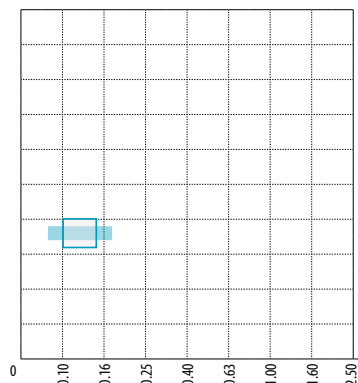
P	M	K	N	S	H
■	▣	■	■	■	■

Consultar diagrama

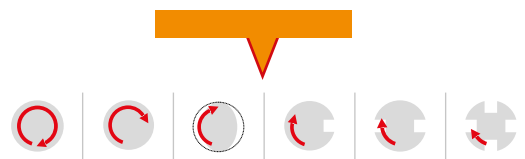

? WCMT 05, WCMX 05

48

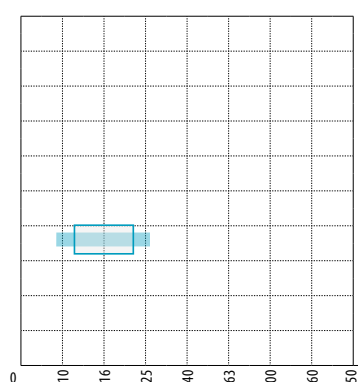
P	M	K	N	S	H
■	▣	■	■	■	■

Consultar diagrama

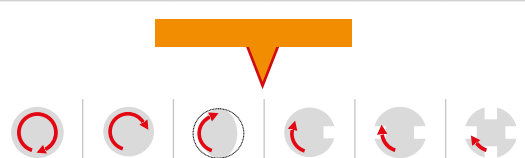

? WCMT 08, WCMX 08

GEOMETRÍA DE PLAQUITAS

UM

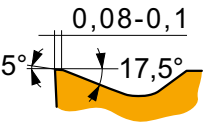
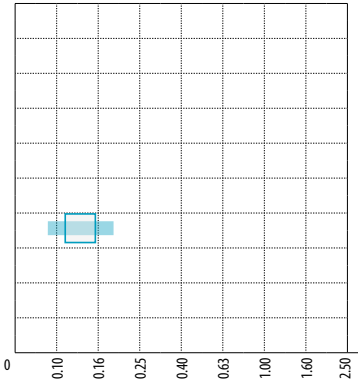
0 0,10 0,16 0,25 0,40 0,63 1,00 1,60 2,50

P **M** **K** **N** **S** **H**

Consultar diagrama

WCMT 04, WCMT 05

SCET.....-UD

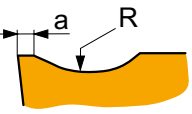
	a
SCET 050204-UD	0,12
SCET 060204-UD	0,15
SCET 070308-UD	0,15
SCET 09T308-UD	0,15
SCET 120408-UD	0,20
SCET 150512-UD	0,20

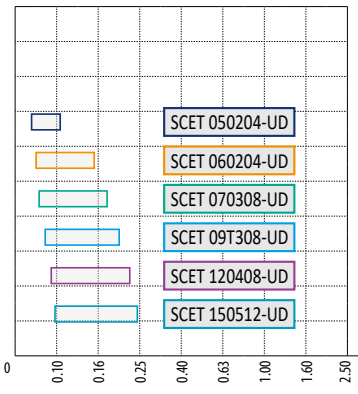

0 0,10 0,16 0,25 0,40 0,63 1,00 1,60 2,50

P **M** **K** **N** **S** **H**

Consultar diagrama

SCET.....-UD

XPET.....AP

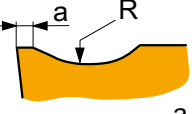
	a
XPET 0502AP	0,10
XPET 0602AP	0,10
XPET 0703AP	0,15
XPET 0903AP	0,25
XPET 11T3AP	0,25
XPET 12T3AP	0,25
XPET 1504AP	0,25
XPET 1904AP	0,25

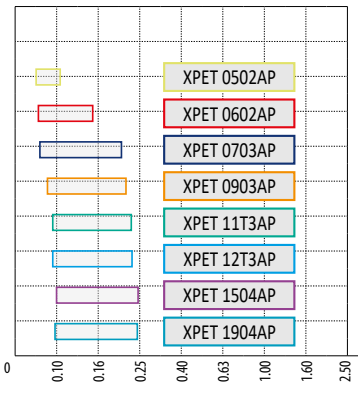

0 0,10 0,16 0,25 0,40 0,63 1,00 1,60 2,50

P **M** **K** **N** **S** **H**

Consultar diagrama

XPET.....AP

SCET-SD

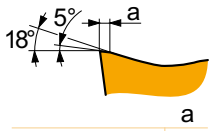

SCET 050204-SD	0,04
SCET 060204-SD	0,06
SCET 070308-SD	0,08
SCET 09T308-SD	0,10
SCET 120408-SD	0,10
SCET 150512-SD	0,10

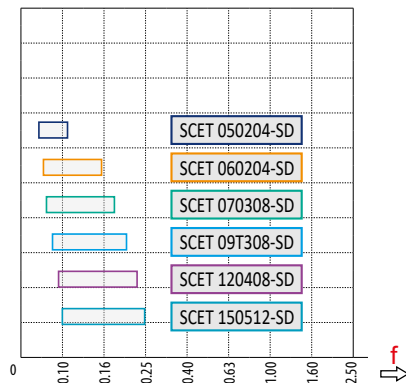

P	M	K	N	S	H
■	■	▣	■	▣	■
f ⇨ Consultar diagrama					
SCET-SD					

XPETAP-SD

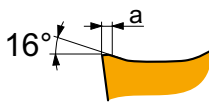

XPET 0502AP-SD	0,04
XPET 0602AP-SD	0,05
XPET 0703AP-SD	0,08
XPET 0903AP-SD	0,10
XPET 11T3AP-SD	0,10
XPET 12T3AP-SD	0,10
XPET 1504AP-SD	0,10
XPET 1904AP-SD	0,12

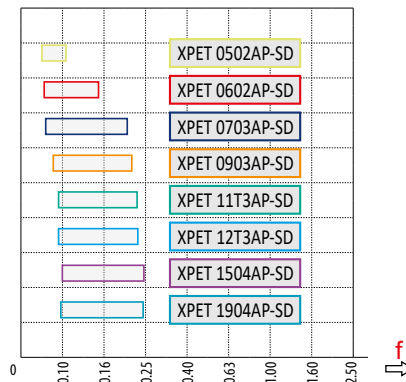

P	M	K	N	S	H
■	■	▣	■	▣	■
f ⇨ Consultar diagrama					
XPETAP-SD					



CALIDADES DE TALADRADO

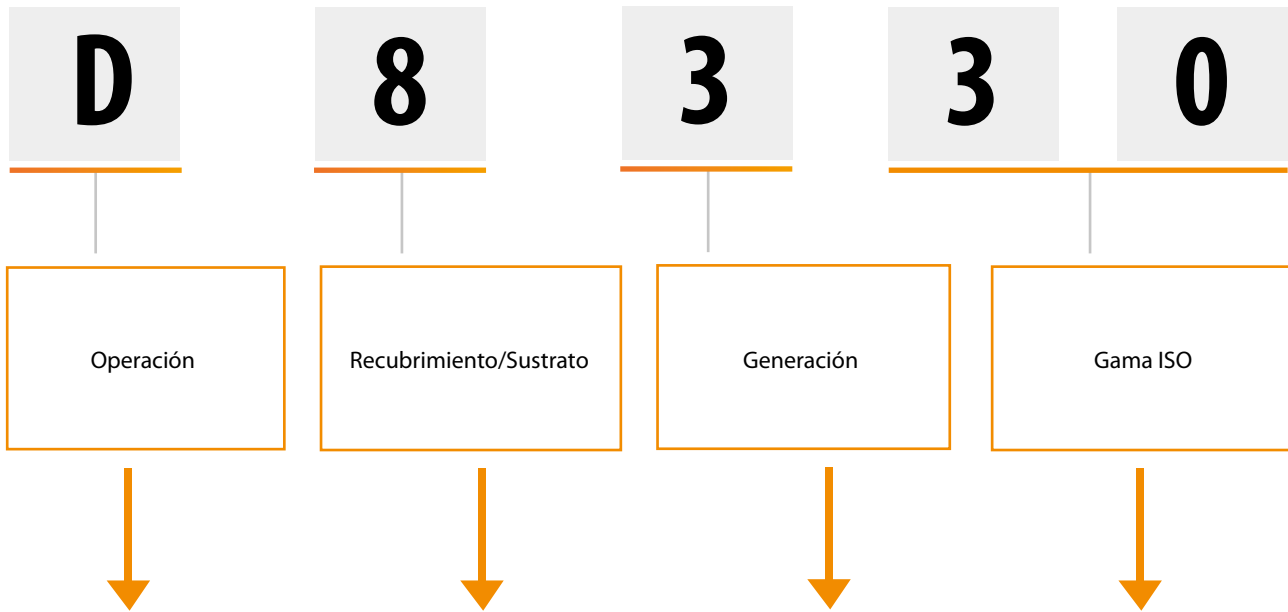

D	Taladrado
M	Fresado
T	Torneado
G	Tronzado y Ranurado

0 PVD 1 CVD	Aplicación especial
2 PVD 3 CVD	Libre
4 PVD 5 CVD	Grupos K, H
6 PVD 7 CVD	Grupos M, S
8 PVD 9 CVD	Universal
B	CBN
C	Cerámica
D	PCD
T	Cermet

1 - 9

01 - 50	
	01 - 05
	05 - 10
	10 - 20
	20 - 30
	30 - 40
	40 - 50



CALIDADES DE TALADRADO

Identificación de la calidad	Área de aplicación	Aplicación	Avance	Velocidad de corte	Resistencia a condiciones de trabajo adversas	Recubrimiento	Color	Sustrato	Ventajas del refrigerante	Descripción de la calidad
D9335	P20 - P35	■				MT-CVD	■	FGM	+++	Esta calidad se recomienda para plaquitas de corte periféricas en brocas de plaquita intercambiable; es más adecuada para velocidades de corte y avances elevados.
	M15 - M30	■								
	K15 - K35	■								
	S10 - S20	☑								
D8330	P20 - P35	■				PVD	■	submicron H	+++	Se trata de una calidad universal para la plaquita de corte periférica en brocas de plaquita intercambiable; se puede utilizar en la mayoría de materiales y destaca por su fiabilidad de funcionamiento.
	M15 - M30	■								
	K15 - K35	■								
	S10 - S20	☑								
D8345	P30 - P50	■				PVD	■	submicron H	+++	Se trata de una calidad universal para la plaquita de corte central en brocas de plaquita intercambiable; es extremadamente resistente, por lo que es válida para la mayoría de materiales existentes.
	M20 - M40	■								
	K30 - K40	■								
	S20 - S30	☑								

Sustrato

submicron H	Sustrato de base WC-Co de grano fino (< 1 µm)
FGM	Sustrato de grado funcional

Recubrimiento

MT-CVD	Método de recubrimiento químico a media temperatura
PVD	Método de recubrimiento físico

Ventajas del refrigerante

+++	Uso esencial de refrigerante
-----	------------------------------



BROCAS DE PLAQUITA INTERCAMBIABLE: CONDICIONES DE CORTE RECOMENDADAS

802D, 803D (XPET..AP, SCET..-UD)



	D9335	D8330	D8345	∅ 15	∅ 20	∅ 25	∅ 30	∅ 40	∅ 58
P1	■	■	■	0.07	0.08	0.09	0.10	0.12	0.16
P2	■	■	■	0.11	0.13	0.15	0.17	0.21	0.28
P3	■	■	■	0.13	0.15	0.18	0.20	0.24	0.32
P4	■	■	■	0.12	0.14	0.16	0.18	0.22	0.30
K1	■	■	■	0.14	0.16	0.19	0.21	0.26	0.34
K2	■	■	■	0.14	0.16	0.19	0.21	0.26	0.34
K3	■	■	■	0.14	0.16	0.19	0.21	0.26	0.34
K4	■	■	■	0.14	0.16	0.19	0.21	0.26	0.34
K5	■	■	■	0.14	0.16	0.19	0.21	0.26	0.34

802D, 803D (XPET..AP-SD, SCET..-SD)



	D9335	D8330	D8345	∅ 15	∅ 20	∅ 25	∅ 30	∅ 40	∅ 58
P1	■	■	■	0.08	0.09	0.10	0.11	0.14	0.18
P2	■	■	■	0.11	0.13	0.15	0.17	0.21	0.28
P3	■	■	■	0.13	0.15	0.18	0.20	0.24	0.32
P4	■	■	■	-	-	-	-	-	-
K1	▣	▣	▣	0.08	0.09	0.10	0.11	0.14	0.18
K2	▣	▣	▣	0.11	0.13	0.15	0.17	0.21	0.28
K3	▣	▣	▣	0.12	0.14	0.16	0.18	0.22	0.24
K4	▣	▣	▣	0.13	0.15	0.18	0.20	0.24	0.32
K5	▣	▣	▣	0.14	0.16	0.19	0.21	0.25	0.33
M1	■	■	■	0.12	0.14	0.16	0.18	0.22	0.30
M2	■	■	■	0.11	0.13	0.15	0.17	0.21	0.28
M3	■	■	■	0.07	0.08	0.09	0.10	0.12	0.16
M4	■	■	■	0.07	0.08	0.09	0.10	0.12	0.16
S1	▣	▣	▣	0.08	0.09	0.10	0.11	0.14	0.18
S2	▣	▣	▣	0.08	0.09	0.10	0.11	0.14	0.18
S3	▣	▣	▣	0.07	0.08	0.09	0.10	0.12	0.16
S4	▣	▣	▣	0.07	0.08	0.09	0.10	0.12	0.16

804D (XPET..AP, SCET..-UD)



	D9335	D8330	D8345	∅ 15	∅ 20	∅ 25	∅ 30	∅ 40	∅ 58
P1	■	■	■	0.06	0.07	0.08	0.09	0.10	0.14
P2	■	■	■	0.10	0.12	0.14	0.16	0.19	0.25
P3	■	■	■	0.12	0.14	0.16	0.18	0.22	0.30
P4	■	■	■	0.11	0.13	0.15	0.17	0.21	0.28
K1	■	■	■	0.13	0.15	0.18	0.20	0.24	0.32
K2	■	■	■	0.13	0.15	0.18	0.20	0.24	0.32
K3	■	■	■	0.13	0.15	0.18	0.20	0.24	0.32
K4	■	■	■	0.13	0.15	0.18	0.20	0.24	0.32
K5	■	■	■	0.13	0.15	0.18	0.20	0.24	0.32



BROCAS DE PLAQUITA INTERCAMBIABLE: CONDICIONES DE CORTE RECOMENDADAS

804D (XPET..AP-SD, SCET..-SD)



	D9335	D8330	D8345	∅ 15	∅ 20	∅ 25	∅ 30	∅ 40	∅ 58
P1	■	■	■	0.07	0.08	0.09	0.10	0.12	0.16
P2	■	■	■	0.10	0.12	0.14	0.16	0.19	0.25
P3	■	■	■	0.12	0.14	0.16	0.18	0.22	0.30
P4	■	■	■	-	-	-	-	-	-
K1	☑	☑	☑	0.07	0.08	0.09	0.10	0.12	0.16
K2	☑	☑	☑	0.10	0.12	0.14	0.16	0.19	0.25
K3	☑	☑	☑	0.11	0.13	0.15	0.17	0.20	0.27
K4	☑	☑	☑	0.12	0.14	0.16	0.18	0.22	0.30
K5	☑	☑	☑	0.14	0.16	0.19	0.21	0.25	0.33
M1	■	■	■	0.11	0.13	0.15	0.17	0.21	0.28
M2	■	■	■	0.10	0.12	0.14	0.16	0.19	0.25
M3	■	■	■	0.06	0.07	0.08	0.09	0.10	0.14
M4	■	■	■	0.06	0.07	0.08	0.09	0.10	0.14
S1	☑	☑	☑	0.07	0.08	0.09	0.10	0.12	0.16
S2	☑	☑	☑	0.07	0.08	0.09	0.10	0.12	0.16
S3	☑	☑	☑	0.06	0.07	0.08	0.09	0.10	0.14
S4	☑	☑	☑	0.06	0.07	0.08	0.09	0.10	0.14

805D (XPET..AP, SCET..-UD)



	D9335	D8330	D8345	∅ 15	∅ 20	∅ 25	∅ 30	∅ 40	∅ 58
P1	■	■	■	0.06	0.07	0.08	0.09	0.10	0.14
P2	■	■	■	0.10	0.12	0.14	0.16	0.19	0.25
P3	■	■	■	0.12	0.14	0.16	0.18	0.22	0.30
P4	■	■	■	0.11	0.13	0.15	0.17	0.21	0.28
K1	■	■	■	0.13	0.15	0.18	0.20	0.24	0.32
K2	■	■	■	0.13	0.15	0.18	0.20	0.24	0.32
K3	■	■	■	0.13	0.15	0.18	0.20	0.24	0.32
K4	■	■	■	0.13	0.15	0.18	0.20	0.24	0.32
K5	■	■	■	0.13	0.15	0.18	0.20	0.24	0.32

805D (XPET..AP-SD, SCET..-SD)



	D9335	D8330	D8345	∅ 15	∅ 20	∅ 25	∅ 30	∅ 40	∅ 58
P1	■	■	■	0.07	0.08	0.09	0.10	0.12	0.16
P2	■	■	■	0.10	0.12	0.14	0.16	0.19	0.25
P3	■	■	■	0.12	0.14	0.16	0.18	0.22	0.30
P4	■	■	■	-	-	-	-	-	-
K1	☑	☑	☑	0.07	0.08	0.09	0.10	0.12	0.16
K2	☑	☑	☑	0.10	0.12	0.14	0.16	0.19	0.25
K3	☑	☑	☑	0.11	0.13	0.15	0.17	0.20	0.27
K4	☑	☑	☑	0.12	0.14	0.16	0.18	0.22	0.30
K5	☑	☑	☑	0.12	0.14	0.16	0.18	0.22	0.30
M1	■	■	■	0.11	0.13	0.15	0.17	0.21	0.28
M2	■	■	■	0.10	0.12	0.14	0.16	0.19	0.25
M3	■	■	■	0.06	0.07	0.08	0.09	0.10	0.14
M4	■	■	■	0.06	0.07	0.08	0.09	0.10	0.14
S1	☑	☑	☑	0.07	0.08	0.09	0.10	0.12	0.16
S2	☑	☑	☑	0.07	0.08	0.09	0.10	0.12	0.16
S3	☑	☑	☑	0.06	0.07	0.08	0.09	0.10	0.14
S4	☑	☑	☑	0.06	0.07	0.08	0.09	0.10	0.14



FÓRMULAS DE CÁLCULO DE LOS PARÁMETROS DE CORTE

NOMENCLATURA Y FÓRMULAS

Parámetro	Fórmula	Unidad
Velocidad del husillo	$n = \frac{v_c \cdot 1000}{DC \cdot \pi}$	(rpm/min)
Velocidad de corte	$v_c = \frac{\pi \cdot DC \cdot n}{1000}$	(m/min)
Velocidad de avance	$v_f = n \cdot f$	(mm/min)
Area de la seccion transversal del agujero	$A = \frac{\pi \cdot DC^2}{4}$	(mm ²)
Volumen de viruta	$Q = \frac{v_f \cdot A}{1000}$	(cm ³ /min)
Tiempo de mecanizado	$T_c = \frac{L + h}{v_f}$	[min/pieza]

DC Diámetro de la broca

(mm)

h Distancia desde el punto de taladrado hasta la pieza que se trabaja antes de avanzar

(mm)







f Avance por revolución

(mm/rev)

L Profundidad del agujero

(mm)

FÓRMULAS DE CÁLCULO DE LOS PARÁMETROS DE CORTE

						
US 2245-T07P	0.9	FLAG T07P	M 2.2	5.3	D-T7P	MR-0.8-2.0 vario
US 2205-T07P	0.9	FLAG T07P	M2.2	5.4	D-T7P	MR-0.8-2.0 vario
US 2506-T07P	1.2	FLAG T07P	M 2.5	6	D-T7P	MR-0.8-2.0 vario
US 2507-T08P	1.2	FLAG T08P	M 2.5	7	D-T8P	MR-0.8-2.0 vario
US 3007-T08P	2.0	FLAG T08P	M 3	7	D-T8P	MR-1.0-5.0 vario
US 3007-T09P	2.0	FLAG T09P	M 3	7.4	D-T9P	MR-1.0-5.0 vario
US 3009-T09P	2.0	FLAG T09P	M 3	8.7	D-T9P	MR-1.0-5.0 vario
US 3508-T15P	3.0	FLAG T15P	M 3.5	8.3	D-T15P	MR-1.0-5.0 vario
US 3510-T15P	3.0	FLAG T15P	M 3.5	10.6	D-T15P	MR-1.0-5.0 vario
US 4011-T15P	3.5	FLAG T15P	M 4	10.7	D-T15P	MR-1.0-5.0 vario
US 5012-T15P	5.0	FLAG T15P	M 5	12.2	D-T15P	MR-1.0-5.0 vario



CARACTERISTICAS DE MECANIZADO PARA BROCAS CON PLAQUITAS INTERCAMBIALES

Ajuste radial

Ajuste del diámetro del agujero y recomendaciones de colocación

Las brocas de plaquita se pueden desplazar fuera del centro para lograr un diámetro del agujero más pequeño o más grande que con la broca. Los valores de ajuste radial se encuentran en la tabla principal de datos de las brocas.

Broca rotativa (centro de mecanizado)

Para taladrar agujeros con tolerancia IT10 y superior con brocas 802D, 803D, 804D y 805D, se recomienda utilizar soportes ajustables.

Broca estacionaria (torno)

Al montar la broca, asegúrese de que la línea del centro de la broca y la línea del centro de la pieza que se trabajará están alineadas. Para lograr un diámetro mayor del agujero, desplace la broca de forma que la plaquita periférica se mueva en ese sentido desde la línea del centro de la pieza que se trabajará.

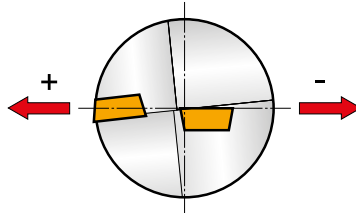

Vida útil de la herramienta

No se deberían utilizar plaquitas con un desgaste en flanco superior a 0,2 – 0,4 mm medidos en el punto mayor.

Las recomendaciones acerca de la velocidad de corte que se mencionan en este catálogo se basan en la vida útil de las plaquitas periféricas en agujeros taladrados con una longitud total de 7 m (durabilidad 20 ÷ 30 min).

EP

CASQUILLO AJUSTABLE

Diám. del mango	Diám. broca	Rango
25	15 – 24	+0.4 – -0.2
32	24.5 – 40	+0.4 – -0.2

Ajuste del diámetro – para centro de mecanizado

Rango de ajuste del diámetro

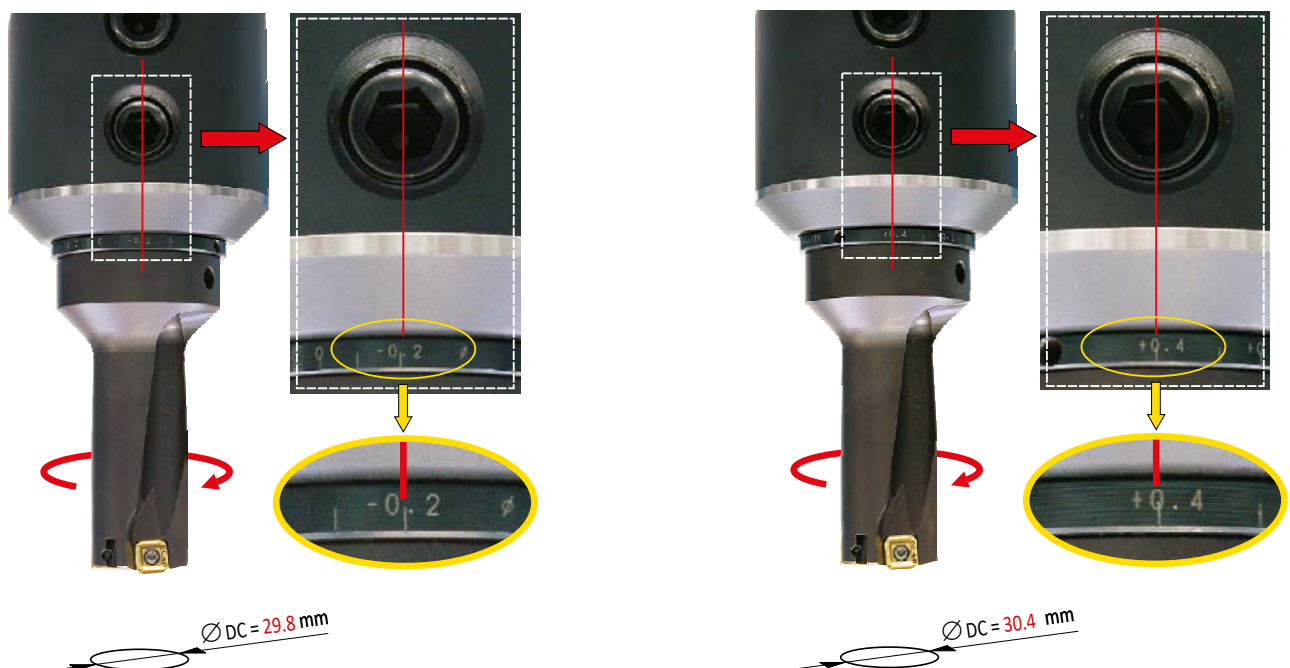



EP

CASQUILLO AJUSTABLE

Diám. del mango	Diám. broca	Rango
25	15 – 24	+0.2 – -0.15
32	24.5 – 40	+0.2 – -0.15

Ajuste del diámetro – para torno

Rango de ajuste de altura centro

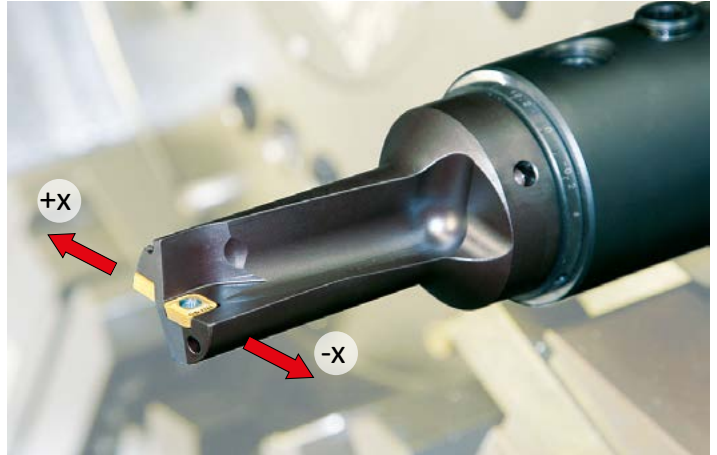

CARACTERISTICAS DE MECANIZADO PARA BROCAS CON PLAQUITAS INTERCAMBIABLES

Presion recomendada del fluido de corte

Diámetro de la broca DC (mm)	Presión del liquido de corte	
	Longitud de la broca	
	2.0 – 2.5 DC	3.0 – 5.0 DC
15 – 25	6 bar	12 bar
26 – 40	4.5 bar	9 bar
> 40	3 bar	6 bar

Requisito de volumen de refrigerante

TALADRADO EN SECO

Se puede taladrar fundición o acero sin refrigerante, aunque se necesitará aire presurizado a través de la broca al realizar el taladrado.

Consumo eléctrico neto

■ $f \Rightarrow = 0.18$
 ■ $f \Rightarrow = 0.12$
 ■ $f \Rightarrow = 0.08$

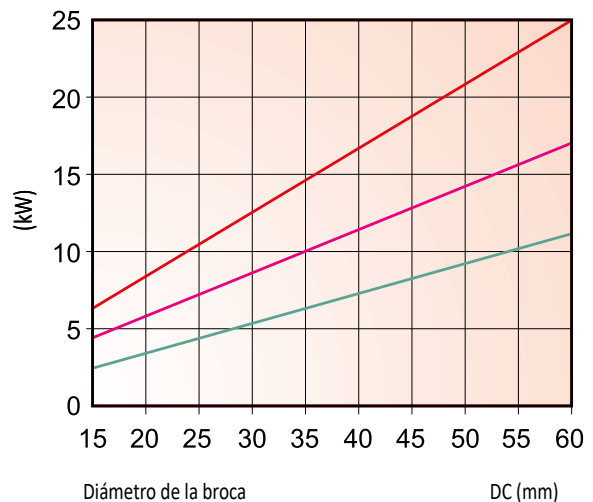
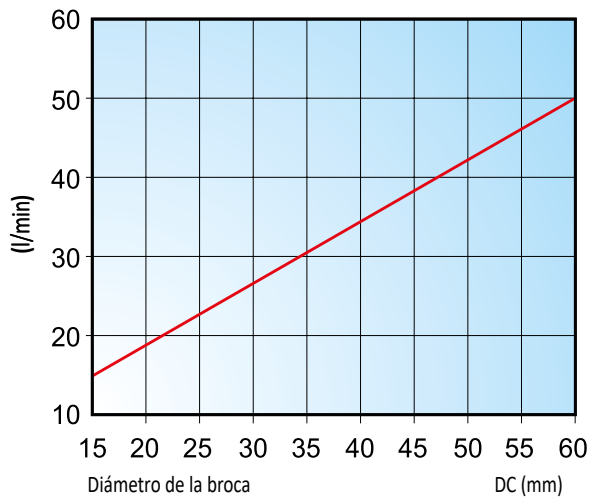



DATOS DE MECANIZADO GENERALES

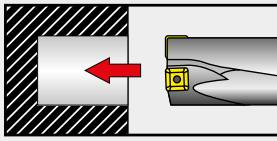

TALADRADO DE AGUJERO CIEGO

Para agujeros con una profundidad mayor de $1xD$ es necesario refrigerante.

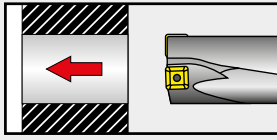

TALADRADO DE AGUJERO PASANTE

Se puede producir un disco a la salida de la broca de plaquitas que puede ser proyectado a gran velocidad cuando la pieza esta girando. Es esencial que la máquina esté protegida adecuadamente para garantizar la seguridad del operario.

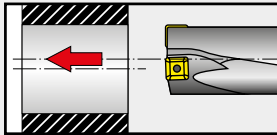

BROCA DESCENTRADA

Reducir el avance al mínimo recomendado para las plaquitas utilizadas. Ver la descripción de las plaquitas. No exceder los valores de ajuste radial.

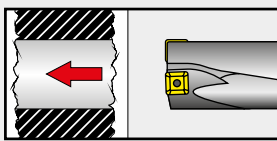

INICIO DEL TALADRADO EN SUPERFICIES IRREGULARES

Reducir el avance un 50% a la entrada hasta que las dos plaquitas estén dentro del agujero.

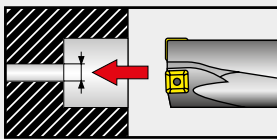

TALADRADO Y MANDRINADO CON AGUJERO PILOTO

Si el agujero piloto es mayor de $1/4$ del diámetro de la broca, reducir el avance.

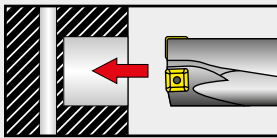

TALADRADO CON AGUJEROS CRUZADOS

Reducir el avance un 50% al taladrar a través de un agujero existente. El diámetro de los agujeros cruzados no debe ser mayor de $0,25xD$.

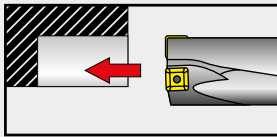

CORTE INTERRUPTO Y PLUNGING

Reducir el avance al mínimo recomendado para las plaquitas utilizadas. Ver la descripción de las plaquitas.

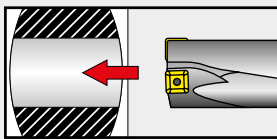

TALADRADO EN SUPERFICIES CURVAS

Se puede taladrar con el centro reduciendo el avance al 50% durante la entrada y la salida.

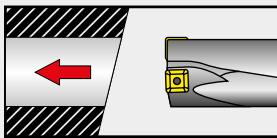

TALADRADO EN SUPERFICIES INCLINADAS

Reducir el avance un 50% a la entrada hasta que las dos plaquitas estén dentro del agujero si el ángulo de entrada es mayor de 5° .

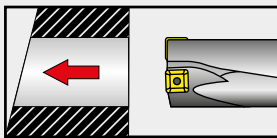

SALIDA EN SUPERFICIES INCLINADAS

Reducir el avance un 50% a la salida si el ángulo de salida es mayor de 5° .

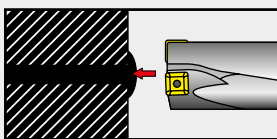

ENTRADA EN SOLDADURA

Se recomienda fresar previamente. Reducir el avance un 50% durante el taladrado del material de soldadura.

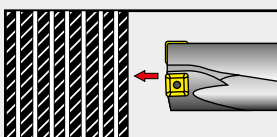

TALADRADO DE CHAPAS O DE PIEZAS APILADAS

Evite dejar espacios de más de $0,2$ mm entre las diferentes capas. El componente debe estar bien sujeto. En caso necesario, reduzca el avance.



RESOLUCION DE PROBLEMAS CON BROCAS DE PLAQUITAS INTERCAMBIABLES

BAJO RENDIMIENTO DEL MOTOR (MOMENTO DE TORSION BAJO EN EL EJE)	<ul style="list-style-type: none">a) reducción de la velocidad de corte; reducción de las revoluciones del ejeb) reducción del avance
DESGASTE EXCESIVO DEL FILO DE LA PLAQUITA DE CORTE PERIFÉRICA	<ul style="list-style-type: none">a) reduzca la velocidad de corte; reduzca las revoluciones del ejeb) escoja una calidad de plaquita más resistente al desgastec) aumente el volumen y la presión del líquido de corte
DESPORTILLADO DE LA PLAQUITA PERIFERICA	<ul style="list-style-type: none">a) reduzca el avance durante el taladrado (sobre todo en superficies de entrada irregulares de las piezas a mecanizar)b) escoja una plaquita más resistente al desgastec) reduzca la velocidad de corte
DESPORTILLADO DE LA PLAQUITA CENTRAL	<ul style="list-style-type: none">a) reduzca el avance al entrarb) compruebe la fijación de la broca y de la pieza a mecanizar
VIRUTA DEFORMADA DE FORMA CONTINUADA	<ul style="list-style-type: none">a) cambie el avanceb) aumente la velocidad de corte y reduzca a la vez el avance
ATASCO DE PEQUEÑAS VIRUTAS EN LAS HENDIDURAS PERIFÉRICAS	<ul style="list-style-type: none">a) aumente el volumen y la presión del líquido de corteb) reduzca la velocidad de cortec) cambie el avance



DIÁMETROS DE BROCA RECOMENDADOS PARA ROSCADO CON MACHO

Roscas ISO métricas		Diámetro de broca recomendado	
Rosca	Paso	Macho de corte	Macho de laminación
M16 × 1.0	1.00	15.0	15.5
M16 × 0.75	0.75	15.3	–
M17 × 1.0	1.00	16.0	–
M18	2.50	15.5	16.8
M18 × 2.0	2.00	16.0	–
M18 × 1.5	1.50	16.5	17.3
M18 × 1.0	1.00	17.0	–
M20	2.50	17.5	18.8
M20 × 2.0	2.00	18.0	–
M20 × 1.5	1.50	18.5	19.3
M20 × 1.0	1.00	19.0	–
M22	2.50	19.5	20.8
M22 × 2.0	2.00	20.0	–
M22 × 1.5	1.50	20.5	21.3
M22 × 1.0	1.00	21.0	–
M24	3.00	21.0	22.5
M24 × 2.0	2.00	22.0	–
M24 × 1.5	1.50	22.5	23.3
M27	3.00	24.0	–
M27 × 2.0	2.00	25.0	–
M30	3.50	26.5	–
M30 × 2.0	2.00	28.0	–
M33	3.50	29.5	–
M36	4.00	32.0	–
M36 × 3.0	3.00	33.0	–
M39	4.00	35.0	–
M42	4.50	37.5	–
M42 × 3.0	3.00	39.0	–
M45	4.50	40.5	–
M48	5.00	43.0	–
M48 × 3.0	3.00	45.0	–
M52	5.00	47.0	–
M52 × 3.0	3.00	48.0	–

Roscas pulgadas UNC		Diámetro de broca recomendado	
Rosca	Paso	Macho de corte	Macho de laminación
3/4"	10	16.7	17.8
7/8"	9	19.5	20.8
1"	8	22.2	23.8
1 1/8"	7	25.0	–
1 1/4"	7	28.2	–
1 3/8"	6	31.0	–
1 1/2"	6	34.0	–
1 3/4"	5	39.5	–
2"	4 1/2	45.2	–
2 1/4"	4 1/2	51.6	–
2 1/2"	4	57.2	–

Roscas Whitworth en tubo		Diámetro de broca recomendado	
Rosca	Paso	Macho de corte	Macho de laminación
G 3/8"	19	15.3	16.0
G 1/2"	14	19.0	20.0
G 5/8"	14	21.0	22.0
G 3/4"	14	24.5	25.5
G 7/8"	14	28.3	29.3
G 1"	11	30.8	32.0
G 1 1/8"	11	35.5	–
G 1 1/4"	11	39.5	–
G 1 3/8"	11	41.8	–
G 1 1/2"	11	45.3	–
G 1 3/4"	11	51.0	–
G 2"	11	57.0	–

Roscas pulgadas UNF		Diámetro de broca recomendado	
Rosca	Paso	Macho de corte	Macho de laminación
3/4"	16	17.5	18.3
7/8"	14	20.5	21.3
1"	12	23.4	24.3
1 1/8"	12	26.5	–
1 1/4"	12	29.8	–
1 3/8"	12	33.0	–
1 1/2"	12	36.0	–



SISTEMAS DE MANDRINADO





MECANIZADO DE AGUJEROS: ÍNDICE GENERAL

6		WMG E ISO 13399
12	BROCAS	INSTRUCCIONES
15		BROCAS DE METAL DURO INTEGRAL
66		BROCAS DE HSS
176		INFORMACIÓN TÉCNICA
186		ACEITES DE CORTE
190		ESCARIADORES Y AVELLANADORES
264	BROCAS DE PLAQUITA INTERCAMBIABLE	INSTRUCCIONES
271		BROCAS HYDRA
297		INFORMACIÓN TÉCNICA
307		BROCAS DE PLAQUITA INTERCAMBIABLE
327		INFORMACIÓN TÉCNICA
350	SISTEMAS DE MANDRILADO	INSTRUCCIONES
359		CABEZALES DE MANDRINADO
376		ACCESORIOS DE MANDRINADO
381		PLAQUITAS DE CORTE
404		ÚTILES DE SUJECCIÓN
418		KITS DE MANDRINADO
429		INFORMACIÓN TÉCNICA



PLAQUITAS DE CORTE: PÁGINA RESUMEN



1 CCGT

	IC (mm)	D1 (mm)	L (mm)	S (mm)
0602	6.350	2.80	6.40	2.38
0602-SF3	6.350	2.80	6.40	2.58
0803-AL	7.940	3.40	8.10	3.43
0803-SF3	7.940	3.40	8.10	3.43
09T3	9.525	4.40	9.70	3.97
09T3-SF3	9.525	4.40	9.70	4.22
1204	12.700	5.50	12.90	4.76
1204-SF3	12.700	5.50	12.90	5.01

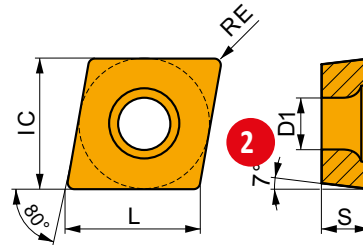

Valores de inicio adecuados para la velocidad de corte (vc), avance (f) y profundidad de corte (ap). Consulte nuestra APP Calculadora de mecanizado para obtener más cálculos.

Product	RE (mm)	P			M			K			N			S			H		
		vc [m/min]	f [mm/rev]	ap [mm]	vc [m/min]	f [mm/rev]	ap [mm]	vc [m/min]	f [mm/rev]	ap [mm]	vc [m/min]	f [mm/rev]	ap [mm]	vc [m/min]	f [mm/rev]	ap [mm]			

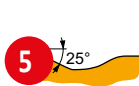

10 Geometría AL con un diseño muy positivo para operaciones de acabado fino a desbaste, con corte continuo y ligeramente interrumpido.

CCGT 060202F-AL	HF7	0.2	-	-	-	-	-	-	-	360	0.12	1.0	-	-	-	-	-	-
CCGT 060204F-AL	T0315	0.4	-	-	-	-	-	-	-	300	0.24	1.0	-	-	-	-	-	-
CCGT 080302F-AL	T0315	0.2	-	-	-	-	-	-	-	360	0.12	1.0	-	-	-	-	-	-
CCGT 080304F-AL	HF7	0.4	-	-	-	-	-	-	-	300	0.24	1.0	-	-	-	-	-	-
	T0315	0.4	-	-	-	-	-	-	-	300	0.24	1.0	-	-	-	-	-	-
CCGT 09T302F-AL	HF7	0.2	-	-	-	-	-	-	-	360	0.12	1.0	-	-	-	-	-	-
	T0315	0.2	-	-	-	-	-	-	-	360	0.12	1.0	-	-	-	-	-	-
CCGT 09T304F-AL	HF7	0.4	-	-	-	-	-	-	-	300	0.24	1.5	-	-	-	-	-	-
	T0315	0.4	-	-	-	-	-	-	-	300	0.24	1.5	-	-	-	-	-	-
CCGT 09T308F-AL	HF7	0.8	-	-	-	-	-	-	-	200	0.48	1.5	-	-	-	-	-	-
	T0315	0.8	-	-	-	-	-	-	-	200	0.48	1.5	-	-	-	-	-	-
CCGT 120404F-AL	HF7	0.4	-	-	-	-	-	-	-	300	0.24	2.4	-	-	-	-	-	-
	T0315	0.4	-	-	-	-	-	-	-	300	0.24	2.4	-	-	-	-	-	-
CCGT 120408F-AL	HF7	0.8	-	-	-	-	-	-	-	200	0.48	2.4	-	-	-	-	-	-
	T0315	0.8	-	-	-	-	-	-	-	200	0.48	2.4	-	-	-	-	-	-

CCGT120404F-AL:T0315

Utilice el código de especificación completo de la plaquita de corte para realizar el pedido.

Calidad

Incluye dos puntos

Código ISO para la plaquita de corte



PLAQUITAS DE CORTE: PÁGINA RESUMEN

Pos.	Descripción	Pos.	Descripción
1	Denominación de la plaquita de corte	7	Código ISO para la plaquita de corte
2	Representación esquemática de la plaquita de corte	8	Calidad
3	Tabla de tamaños de plaquita de corte (mm)	9	Radios de plaquita de corte (mm)
4	Imagen representativa de una plaquita de corte	10	Descripción de la geometría
5	Perfil del filo de corte principal	11	Área de aplicación de la plaquita de corte
6	Símbolos: características especiales y tipo de filo de corte		



HERRAMIENTAS DE MANDRINADO Y CONOS – VISIÓN GENERAL

1 D75-BB

P M K N S H 2

PRAMET 3 S(P)



Cabeza de Mandrinar para Desbaste, Áng. de Posición 75°, Agujero Grande - de Ø220 hasta Ø500 mm
 Cabeza de mandrinado de alto rendimiento de tamaño grande a 75° para desbaste. Adecuada para mandrinado y achaflanado de agujeros pasantes, ciegos y con agujeros cruzados. Disponible para utilizar plaquitas tipo CC., TC. o CN. y para diámetros de agujero de Ø220 a Ø500 mm con tamaños de mandril de 300 a 500 mm. Alta precisión y repetibilidad.

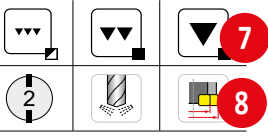
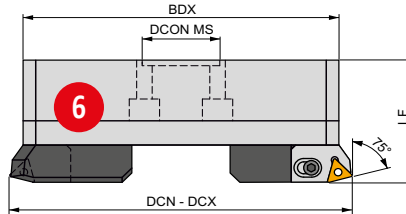

Product	CZC MS	DCN	DCX	BDX	DCON MS	LF	Icon 1	Icon 2	Icon 3	Icon 4	Icon 5	Icon 6	Icon 7	Icon 8	Icon 9	Icon 10
	(mm)	(mm)	(mm)	(mm)	(mm)	(mm)										
D 30075 300	300	220.00	320.00	202	60.00	90.00	3CT 75 300	US 0625	HXK 5	TC.. 16T3..	US 0415-T15P	SDR T15P	HXK 5	HXK 4	9.40	
D 30075 402	300	220.00	320.00	202	60.00	90.00	3CT 75 402	US 0625	HXK 5	CC.. 1204..	US 0513-T20P	SDR T20P	HXK 5	HXK 4	9.37	
D 30075 402N	300	220.00	320.00	202	60.00	90.00	3CT 75 402 N	US 0625	HXK 5	CN.. 1204..	US 0613-H25	HXK 2.5	HXK 5	HXK 4	9.37	
D 40075 300	400	290.00	400.00	272	60.00	90.00	3CT 75 300 N	US 0625	HXK 5	TC.. 16T3..	US 0415-T15P	SDR T15P	HXK 5	HXK 4	11.78	
D 40075 402	400	290.00	400.00	272	60.00	90.00	3CT 75 402 N	US 0625	HXK 5	CC.. 1204..	US 0513-T20P	SDR T20P	HXK 5	HXK 4	11.78	
D 40075 402N	400	290.00	400.00	272	60.00	90.00	3CT 75 402 N	US 0625	HXK 5	CN.. 1204..	US 0613-H25	HXK 2.5	HXK 5	HXK 4	11.78	

1 69871-BS

PRAMET



Portaherramientas de Mango DIN 69871-BS para Cabezas de Mandrinar
 Portaherramientas de alta rigidez DIN 69871 (para ATC) para cabezas de mandrinar con cono 30, 40 y 50. Diferentes longitudes disponibles. Los tamaños de acoplamiento de 22 a 160 mm se pueden utilizar en combinación con extensores EXT-BS, reductores RED-BS y ampliadores LA-BS. Refrigeración interna disponible. Para aplicaciones que requieren alta precisión y repetibilidad.

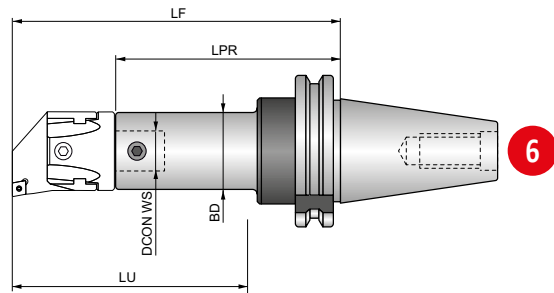

Product	Icon 1	CZC MS	BD	DCON WS	LF	LPR	LU	Icon 2	Icon 3	Icon 4
		(mm)	(mm)	(mm)	(mm)	(mm)	(mm)			(kg)
AS 330 022 100 R		30	22	22.00	12.00	138.00	104	✓	US 0608	0.72
AS 330 027 055 R		30	27	27.00	15.00	90.00	48	✓	US 0609	0.56
AS 330 027 100 R		30	27	27.00	15.00	138.00	96	✓	US 0609	0.68
AS 330 060 R		33	24	32.00	20.00	138.00	51	✓	US 0608	0.68
AS 330 100 R		33	24	32.00	20.00	138.00	93	✓	US 0608	0.72
AS 340 022 080 R		40	22	22.00	12.00	118.00	84	✓	US 0608	1.14



HERRAMIENTAS DE MANDRINADO Y CONOS – VISIÓN GENERAL

Pos.	Denominación	Pos.	Denominación
1	Designación de la cabeza de mandrinar/cono	13	Cartuchos
2	Guapos de material	14	Tornillo de cartucho
3	Sistema de fijación de la plaquita	15	LLave para tornillo de cartucho
4	Esquema Ilustrativo	16	Grupo de plaquitas compatibles
5	Descripción de la herramienta	17	Tornillo de plaquita
6	Representación esquemática de la herramienta	18	LLave para tornillo de plaquita
7	Calidad de superficie posible	19	LLave de ajuste para la cabeza
8	Características del producto	20	LLave de bloqueo para cabeza
9	Aplicaciones del producto	21	Peso (kg)
10	Codificación ¹⁾	22	Refrigeración interna
11	Código de tamaño de la cabeza/barra ²⁾	23	Tornillo de amarre para cabeza
12	Dimensiones (mm)	24	Tamaño de cono ³⁾

¹⁾ La codificación está incluida en la parte técnica

²⁾ La cabeza y la barra deben tener el mismo código de tamaño para garantizar su compatibilidad.

³⁾ Ver esquema para tipo de cono



DORMER PRAMET



CUALQUIER MATERIAL

Nuestra aplicación de cálculo abarca el mecanizado de acero, acero inoxidable, fundición, superaleaciones y materiales no férricos. Descárguela hoy mismo en su tienda de aplicaciones. **Simplemente fiables.**

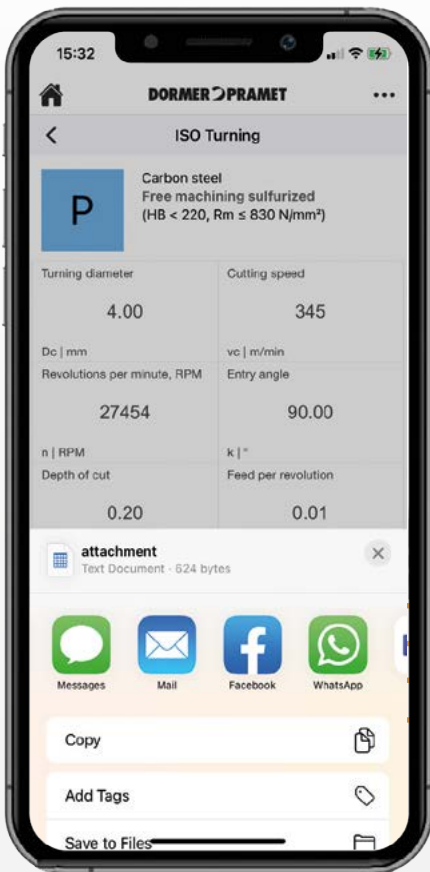



MANDRINADO: RESUMEN DE SÍMBOLOS

SÍMBOLOS GENERALES

	Uso principal		Acabado: calidad superficial muy buena		Desbaste: rugosidad superficial ilimitada
	Uso posible		Mecanizado medio: calidad superficial buena		

CARACTERÍSTICAS GENERALES DE LAS HERRAMIENTAS

	1 diente efectivo por revolución		Diámetro de herramienta ajustable
	2 dientes efectivos por revolución		

OPERACIONES DE TALADRADO

	Mandrinado de agujeros ciegos		Mandrinado hasta una escuadra		Achaflanado (biselado) en agujero
	Mandrinado con agujeros transversales		Achaflanado (biselado)		Mandrinado de agujeros pasantes

CARACTERÍSTICAS

	Primera elección		Alta velocidad		Filo con faceta
	Para materiales de viruta corta		Voladizo largo		Filo redondeado
	Para materiales difíciles de mecanizar (viruta larga)		Piezas con paredes finas y delgadas		Filo redondeado con doble faceta
	Condiciones de trabajo pesadas		Opcion de uso universal		Filo redondeado con faceta
					Filo vivo

OTROS





	Tamaño del cono
--	-----------------

PARTE TÉCNICA

	Avance (mm/rev)		Velocidad de corte media, rigidez del sistema limitada (corte ligeramente interrumpido)
	Velocidad de corte muy alta (condiciones estables)		Velocidad de corte baja, rigidez del sistema baja (corte interrumpido)
	Velocidad de corte alta, alta rigidez del sistema (condiciones estables)		Velocidad de corte muy baja, rigidez del sistema muy baja (condiciones muy inestables)
	Velocidad de corte media, rigidez del sistema limitada (corte ligeramente interrumpido)		



SISTEMA DE MANDRINADO



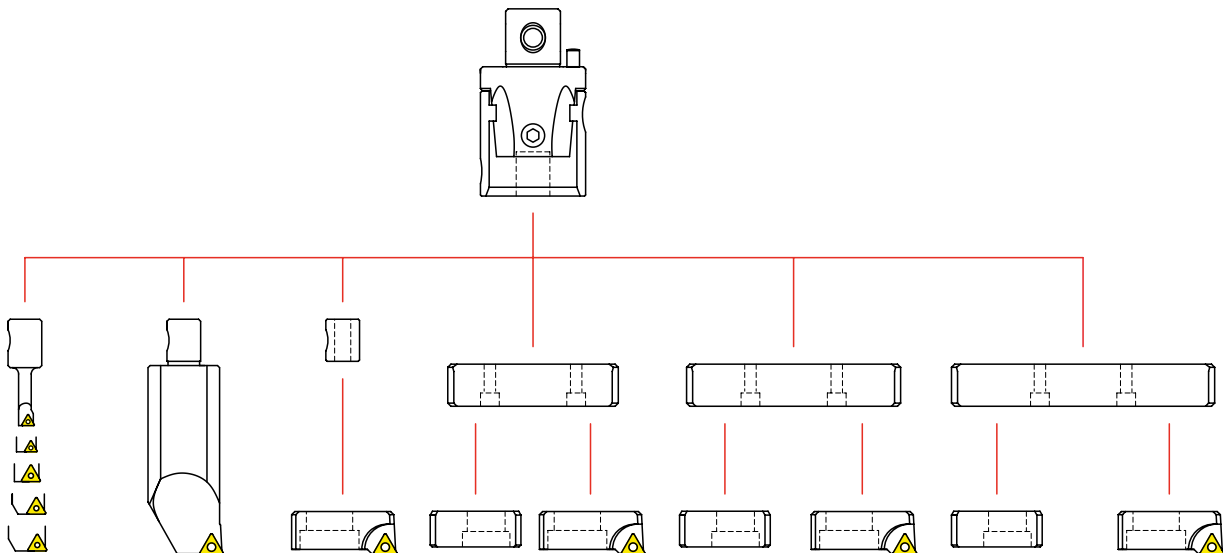

	CABEZALES DE DESBASTE		
			
Descripción	D75 / D90	D75-C/D90-C	D75-BB/D90-BB
Diámetro de mandrinado	24 – 82	80 – 220	220 – 500
Tolerancia del agujero	IT9	IT9	IT9
Profundidad de mandrinado máxima	5×D	4×D	360 mm
Angulo de entrada	75° / 90°	75° / 90°	75° / 90°
Precisión de ajuste (mm/Ø)	–	–	–
	361, 364	362, 365	363, 366

KITS DE MANDRINADO – 420 – 427





SISTEMA DE MANDRINADO

CABEZALES DE ACABADO			CABEZALES MICRO	
				
F75/F90	F75-C/F90-C	F75-BB/F90-BB	MB-H	
24 – 82	80 – 220	220 – 500	8 – 38	
IT7	IT7	IT7	IT6	
5×D	4×D	–	104 mm	
75° / 90°	75° / 90°	75° / 90°	–	
0.002	0.002	0.002	0.002	
367, 370	368, 371	369, 372	373	

BARRAS DE MANDRINAR

BARRAS ISO	BARRAS ISO A042	CHAM-BS CABEZAS DE ACHAFLANADO	CART-BS CARTUCHOS	PLAQUITAS
				
 374	 375	 380	 378	 388



SISTEMA DE MANDRINADO

CONOS PORTAHERRAMIENTAS

69871-BS ISO 30, 40, 50	BT-BS ISO 30, 40, 50	HSK-BS 50A, 63A, 100A	2080-BS ISO 40, 50	MOR-BS MORSE	WEL-BS WELDON
406	408	410	411	413	414

ACCESORIOS

EXT-BS	RED-BS	LA-BS
415	416	417

KITS DE MANDRINADO – 420 – 427





CABEZAS DE MANDRINADO

**DESCRIPCIÓN**

1	2	3	4
D	042	75	402N

1		2	3	4	
Tipo de herramienta		Tamaño	Ángulo de posición	Código de asiento de plaquita	
D	Desbaste	022	75	300	TC..16T3.
		027	90	400	CC..0602..
		032		401	CC..0803..
		042		402	CC..1204..
A	Acabado	054		409	CC..09T3..
		068		402N	CN..1204..
		085			
		100			
		200			
		300			
		400			
		500			



D75

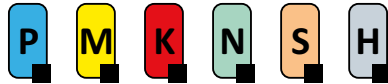

PRAMET

S(P)



Cabeza de Mandrinar para Desbaste, Áng. de Posición 75°, Agujero Pequeño - de Ø24 hasta Ø82 mm

Cabeza de mandrinado de alto rendimiento de tamaño pequeño a 75° para desbaste. Adecuada para mandrinado y achaflanado de agujeros pasantes, ciegos y con agujeros cruzados. Disponible para utilizar plaquitas tipo CC .., TC .. o CN .. y para diámetros de agujero de Ø24 a Ø82 mm con tamaños de mandril de 22 a 54 mm. Alta precisión y repetibilidad.

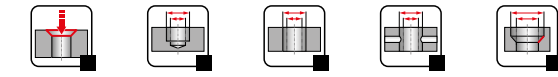
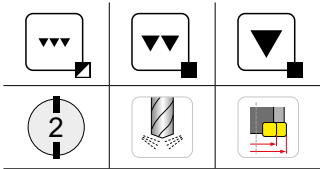
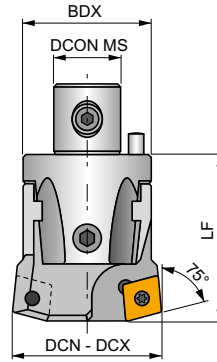

Producto	CZC MS	DCN	DCX	BDX	DCON MS	LF						
		(mm)	(mm)	(mm)	(mm)	(mm)						
D 02275 400	22	24.00	30.00	22	12.00	34.00	CC.. 0602..	US 0206-T08P	SDR T08P	HXK 2	HXK 3	0.10
D 02775 401	27	29.00	40.00	27	15.00	42.00	CC.. 0803..	US 0307-T10P	SDR T10P	HXK 2	HXK 4	0.17
D 02775 409	27	29.00	40.00	27	15.00	42.00	CC.. 09T3..	US 0408-T15P	SDR T15P	HXK 2	HXK 4	0.17
D 03275 401	32	39.00	50.00	32	20.00	45.00	CC.. 0803..	US 0307-T10P	SDR T10P	HXK 2.5	HXK 4	0.27
D 03275 409	32	39.00	50.00	32	20.00	45.00	CC.. 09T3..	US 0408-T15P	SDR T15P	HXK 2.5	HXK 4	0.27
D 04275 300	42	49.00	65.00	42	24.00	56.00	TC.. 16T3..	US 0415-T15P	SDR T15P	HXK 3	HXK 5	0.54
D 04275 402	42	49.00	65.00	42	24.00	56.00	CC.. 1204..	US 0513-T20P	SDR T20P	HXK 3	HXK 5	0.54
D 04275 402N	42	53.00	65.00	42	24.00	56.00	CN.. 1204..	US 0613-H25	HXK 2.5	HXK 3	HXK 5	0.53
D 05475 300	54	63.00	82.00	54	28.00	66.00	TC.. 16T3..	US 0415-T15P	SDR T15P	HXK 3	HXK 6	1.07
D 05475 402	54	63.00	82.00	54	28.00	66.00	CC.. 1204..	US 0513-T20P	SDR T20P	HXK 3	HXK 6	1.07
D 05475 402N	54	63.00	82.00	54	28.00	66.00	CN.. 1204..	US 0613-H25	HXK 2.5	HXK 3	HXK 6	1.03



D75-C

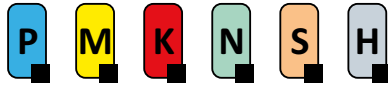

PRAMET

S(P)



Cabeza de Mandrinar para Desbaste, Áng. de Posición 75°, Agujero Medio - de Ø80 hasta Ø220 mm

Cabeza de mandrinado de alto rendimiento de tamaño medio a 75° para desbaste. Adecuada para mandrinado y achaflanado de agujeros pasantes, ciegos y con agujeros cruzados. Disponible para utilizar plaquitas tipo CC .., TC .. o CN .. y para diámetros de agujero de Ø80 a Ø220 mm con tamaños de mandril de 68 a 200 mm. Alta precisión y repetibilidad.

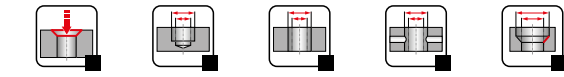
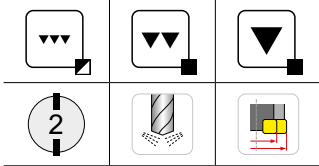
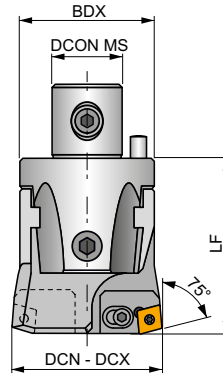

Producto	CZC MS	DCN	DCX	BDX	DCON MS	LF									
		(mm)	(mm)	(mm)	(mm)	(mm)									
D 06875 300	68	80.00	102.00	68	36.00	86.00	2CT 75 300	US 0616	HXK 5	TC.. 16T3..	US 0408-T15P	SDRT15P	HXK 4	HXK 8	2.16
D 06875 402	68	80.00	102.00	68	36.00	86.00	2CT 75 402	US 0616	HXK 5	CC.. 1204..	US 0509-T20P	SDRT20P	HXK 4	HXK 8	2.15
D 06875 402N	68	80.00	102.00	68	36.00	86.00	2CT 75 402 N	US 0616	HXK 5	CN.. 1204..	US 0613-H25	HXK 2.5	HXK 4	HXK 8	2.21
D 08575 300	85	100.00	125.00	85	50.00	100.00	3CT 75 300	US 0625	HXK 5	TC.. 16T3..	US 0415-T15P	SDRT15P	HXK 5	HXK 8	4.16
D 08575 402	85	100.00	125.00	85	50.00	100.00	3CT 75 402	US 0625	HXK 5	CC.. 1204..	US 0513-T20P	SDRT20P	HXK 5	HXK 8	4.13
D 08575 402N	85	100.00	125.00	85	50.00	100.00	3CT 75 402 N	US 0625	HXK 5	CN.. 1204..	US 0613-H25	HXK 2.5	HXK 5	HXK 8	4.23
D 10075 300	100	125.00	160.00	110	60.00	100.00	3CT 75 300	US 0625	HXK 5	TC.. 16T3..	US 0415-T15P	SDRT15P	HXK 5	HXK 8	6.57
D 10075 402	100	125.00	160.00	110	60.00	100.00	3CT 75 402	US 0625	HXK 5	CC.. 1204..	US 0513-T20P	SDRT20P	HXK 5	HXK 8	6.55
D 10075 402N	100	125.00	160.00	110	60.00	100.00	3CT 75 402 N	US 0625	HXK 5	CN.. 1204..	US 0613-H25	HXK 2.5	HXK 5	HXK 8	6.57
D 20075 300	200	160.00	220.00	145	60.00	100.00	3CT 75 300	US 0625	HXK 5	TC.. 16T3..	US 0415-T15P	SDRT15P	HXK 5	HXK 8	8.87
D 20075 402	200	160.00	220.00	145	60.00	100.00	3CT 75 402	US 0625	HXK 5	CC.. 1204..	US 0513-T20P	SDRT20P	HXK 5	HXK 8	8.88
D 20075 402N	200	160.00	220.00	145	60.00	100.00	3CT 75 402 N	US 0625	HXK 5	CN.. 1204..	US 0613-H25	HXK 2.5	HXK 5	HXK 8	8.95



D75-BB

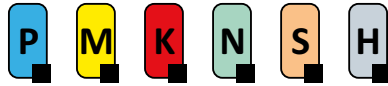

PRAMET

S(P)



Cabeza de Mandrinar para Desbaste, Áng. de Posición 75°, Agujero Grande - de Ø220 hasta Ø500 mm

Cabeza de mandrinado de alto rendimiento de tamaño grande a 75° para desbaste. Adecuada para mandrinado y achaflanado de agujeros pasantes, ciegos y con agujeros cruzados. Disponible para utilizar plaquitas tipo CC., TC. o CN. y para diámetros de agujero de Ø220 a Ø500 mm con tamaños de mandril de 300 a 500 mm. Alta precisión y repetibilidad.

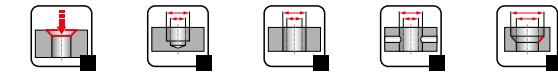
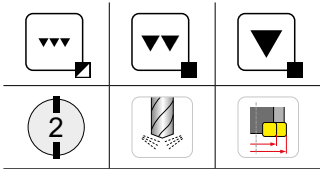
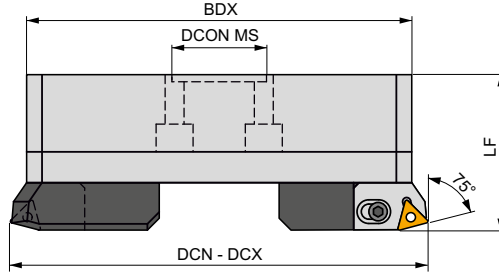

Producto	CZC MS	DCN	DCX	BDX	DCON MS	LF										
		(mm)	(mm)	(mm)	(mm)	(mm)										
D 30075 300	300	220.00	320.00	202	60.00	90.00	3CT 75 300	US 0625	HXK 5	TC.. 16T3..	US 0415-T15P	SDRT15P	HXK 5	HXK 4	9.40	
D 30075 402	300	220.00	320.00	202	60.00	90.00	3CT 75 402	US 0625	HXK 5	CC.. 1204..	US 0513-T20P	SDRT20P	HXK 5	HXK 4	9.37	
D 30075 402N	300	220.00	320.00	202	60.00	90.00	3CT 75 402 N	US 0625	HXK 5	CN.. 1204..	US 0613-H25	HXK 2.5	HXK 5	HXK 4	9.37	
D 40075 300	400	290.00	400.00	272	60.00	90.00	3CT 75 300	US 0625	HXK 5	TC.. 16T3..	US 0415-T15P	SDRT15P	HXK 5	HXK 4	12.92	
D 40075 402	400	290.00	400.00	272	60.00	90.00	3CT 75 402	US 0625	HXK 5	CC.. 1204..	US 0513-T20P	SDRT20P	HXK 5	HXK 4	12.95	
D 40075 402N	400	290.00	400.00	272	60.00	90.00	3CT 75 402 N	US 0625	HXK 5	CN.. 1204..	US 0613-H25	HXK 2.5	HXK 5	HXK 4	12.98	
D 50075 300	500	370.00	500.00	352	60.00	90.00	3CT 75 300	US 0625	HXK 5	TC.. 16T3..	US 0415-T15P	SDRT15P	HXK 5	HXK 4	16.74	
D 50075 402	500	370.00	500.00	352	60.00	90.00	3CT 75 402	US 0625	HXK 5	CC.. 1204..	US 0513-T20P	SDRT20P	HXK 5	HXK 4	16.74	
D 50075 402N	500	370.00	500.00	352	60.00	90.00	3CT 75 402 N	US 0625	HXK 5	CN.. 1204..	US 0613-H25	HXK 2.5	HXK 5	HXK 4	16.74	



D90

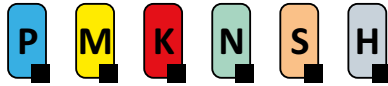

PRAMET

S(P)



Cabeza de Mandrinar para Desbaste, Áng. de Posición 90°, Agujero Pequeño - de Ø24 hasta Ø82 mm

Cabeza de mandrinado de alto rendimiento de tamaño pequeño a 90° para desbaste. Adecuada para mandrinado de agujeros pasantes, ciegos y con agujeros cruzados. Disponible para utilizar plaquitas tipo CC .., TC .. o CN .. y para diámetros de agujero de Ø24 a Ø82 mm con tamaños de mandril de 22 a 54 mm. Alta precisión y repetibilidad.

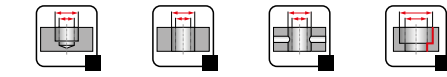
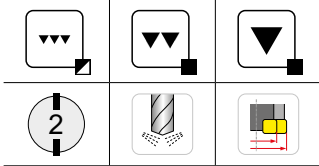
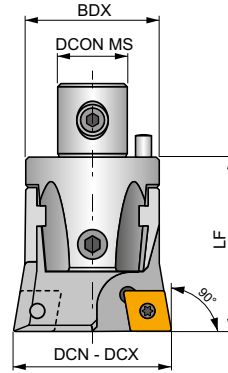

Producto	CZC MS	DCN	DCX	BDX	DCON MS	LF						
		(mm)	(mm)	(mm)	(mm)	(mm)						kg
D 02290 400	22	24.00	30.00	22	12.00	34.00	CC.. 0602..	US 0206-T08P	SDT T08P	HXX 2	HXX 3	0.10
D 02790 401	27	29.00	40.00	27	15.00	42.00	CC.. 0803..	US 0307-T10P	SDR T10P	HXX 2	HXX 4	0.17
D 02790 409	27	29.00	40.00	27	15.00	42.00	CC.. 09T3..	US 0408-T15P	SDR T15P	HXX 2	HXX 4	0.17
D 03290 401	32	39.00	50.00	32	20.00	45.00	CC.. 0803..	US 0307-T10P	SDR T10P	HXX 2.5	HXX 4	0.03
D 03290 409	32	39.00	50.00	32	20.00	45.00	CC.. 09T3..	US 0408-T15P	SDR T15P	HXX 2.5	HXX 4	0.27
D 04290 300	42	49.00	65.00	42	24.00	56.00	TC.. 16T3..	US 0415-T15P	SDR T15P	HXX 3	HXX 5	0.54
D 04290 402	42	49.00	65.00	42	24.00	56.00	CC.. 1204..	US 0513-T20P	SDR T20P	HXX 3	HXX 5	0.54
D 04290 402N	42	53.00	65.00	42	24.00	56.00	CN.. 1204..	US 0613-H25	HXX 2.5	HXX 3	HXX 5	0.53
D 05490 300	54	63.00	82.00	54	28.00	66.00	TC.. 16T3..	US 0415-T15P	SDR T15P	HXX 3	HXX 6	1.06
D 05490 402	54	63.00	82.00	54	28.00	66.00	CC.. 1204..	US 0513-T20P	SDR T20P	HXX 3	HXX 6	1.06
D 05490 402N	54	63.00	82.00	54	28.00	66.00	CN.. 1204..	US 0613-H25	HXX 2.5	HXX 3	HXX 6	1.06



D90-C



PRAMET

S(P)



Cabeza de Mandrinar para Desbaste, Áng. de Posición 90°, Agujero Medio - de Ø80 hasta Ø220 mm

Cabeza de mandrinado de alto rendimiento de tamaño medio a 90° para desbaste. Adecuada para mandrinado de agujeros pasantes, ciegos y con agujeros cruzados. Disponible para utilizar plaquitas tipo CC .., TC .. o CN .. y para diámetros de agujero de Ø80 a Ø220 mm con tamaños de mandril de 68 a 200 mm. Alta precisión y repetibilidad.

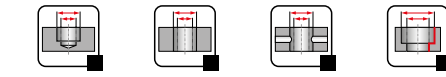
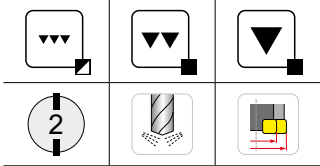
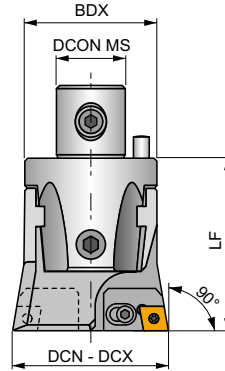

Producto	CZC MS	DCN	DCX	BDX	DCON MS	LF									
		(mm)	(mm)	(mm)	(mm)	(mm)									
D 06890 300	68	80.00	102.00	68	36.00	86.00	2CT 90 300	US 0616	HXK 5	TC.. 16T3..	US 0408-T15P	SDR T15P	HXK 4	HXK 8	2.17
D 06890 402	68	80.00	102.00	68	36.00	86.00	2CT 90 402	US 0616	HXK 5	CC.. 1204..	US 0509-T20P	SDR T20P	HXK 4	HXK 8	2.15
D 06890 402N	68	80.00	102.00	68	36.00	86.00	2CT 90 402 N	US 0616	HXK 5	CN.. 1204..	US 0613-H25	HXK 2.5	HXK 4	HXK 8	2.18
D 08590 300	85	100.00	125.00	85	50.00	100.00	3CT 90 300	US 0625	HXK 5	TC.. 16T3..	US 0415-T15P	SDR T15P	HXK 5	HXK 8	4.52
D 08590 402	85	100.00	125.00	85	50.00	100.00	3CT 90 402	US 0625	HXK 5	CC.. 1204..	US 0513-T20P	SDR T20P	HXK 5	HXK 8	4.12
D 08590 402 N	85	100.00	125.00	85	50.00	100.00	3CT 90 402 N	US 0625	HXK 5	CN.. 1204..	US 0613-H25	HXK 2.5	HXK 5	HXK 8	4.17
D 10090 300	100	125.00	160.00	110	60.00	100.00	3CT 90 300	US 0625	HXK 5	TC.. 16T3..	US 0415-T15P	SDR T15P	HXK 5	HXK 8	6.54
D 10090 402	100	125.00	160.00	110	60.00	100.00	3CT 90 402	US 0625	HXK 5	CC.. 1204..	US 0513-T20P	SDR T20P	HXK 5	HXK 8	6.56
D 10090 402 N	100	125.00	160.00	110	60.00	100.00	3CT 90 402 N	US 0625	HXK 5	CN.. 1204..	US 0613-H25	HXK 2.5	HXK 5	HXK 8	6.40
D 20090 300	200	160.00	220.00	145	60.00	100.00	3CT 90 300	US 0625	HXK 5	TC.. 16T3..	US 0415-T15P	SDR T15P	HXK 5	HXK 8	8.90
D 20090 402	200	160.00	220.00	145	60.00	100.00	3CT 90 402	US 0625	HXK 5	CC.. 1204..	US 0513-T20P	SDR T20P	HXK 5	HXK 8	8.89
D 20090 402 N	200	160.00	220.00	145	60.00	100.00	3CT 90 402 N	US 0625	HXK 5	CN.. 1204..	US 0613-H25	HXK 2.5	HXK 5	HXK 8	8.91



D90-BB

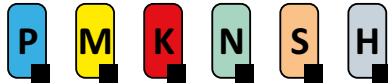

PRAMET

S(P)



Cabeza de Mandrinar para Desbaste, Áng. de Posición 90°, Agujero Grande - de Ø220 hasta Ø500 mm

Cabeza de mandrinado de alto rendimiento de tamaño grande a 90° para desbaste. Adecuada para mandrinado de agujeros pasantes, ciegos y con agujeros cruzados. Disponible para utilizar plaquitas tipo CC .., TC .. o CN .. y para diámetros de agujero de Ø220 a Ø500 mm con tamaños de mandril de 300 a 500 mm. Alta precisión y repetibilidad.

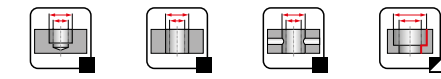
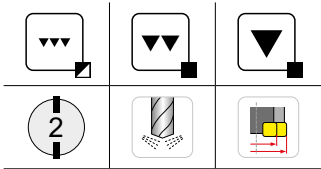
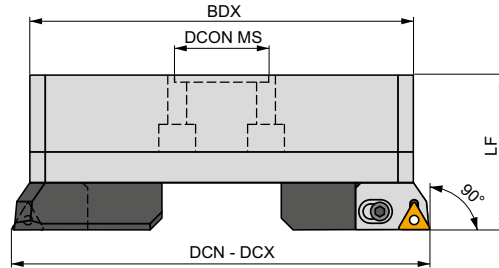

Producto	CZC MS	DCN	DCX	BDX	DCON MS	LF									
		(mm)	(mm)	(mm)	(mm)	(mm)									kg
D 30090 300	300	220.00	320.00	202	60.00	90.00	3CT 90 300	US 0625	HXX 5	TC.. 16T3..	US 0415-T15P	SDRT15P	HXX 5	HXX 4	9.45
D 30090 402	300	220.00	320.00	202	60.00	90.00	3CT 90 402	US 0625	HXX 5	CC.. 1204..	US 0513-T20P	SDRT20P	HXX 5	HXX 4	9.47
D 30090 402 N	300	220.00	320.00	202	60.00	90.00	3CT 90 402 N	US 0625	HXX 5	CN.. 1204..	US 0613-H25	HXX 2.5	HXX 5	HXX 4	9.56
D 40090 300	400	290.00	400.00	272	60.00	90.00	3CT 90 300	US 0625	HXX 5	TC.. 16T3..	US 0415-T15P	SDRT15P	HXX 5	HXX 4	12.98
D 40090 402	400	290.00	400.00	272	60.00	90.00	3CT 90 402	US 0625	HXX 5	CC.. 1204..	US 0513-T20P	SDRT20P	HXX 5	HXX 4	12.98
D 40090 402 N	400	290.00	400.00	272	60.00	90.00	3CT 90 402 N	US 0625	HXX 5	CN.. 1204..	US 0613-H25	HXX 2.5	HXX 5	HXX 4	12.98
D 50090 300	500	370.00	500.00	352	60.00	90.00	3CT 90 300	US 0625	HXX 5	TC.. 16T3..	US 0415-T15P	SDRT15P	HXX 5	HXX 4	16.58
D 50090 402	500	370.00	500.00	352	60.00	90.00	3CT 90 402	US 0625	HXX 5	CC.. 1204..	US 0513-T20P	SDRT20P	HXX 5	HXX 4	16.74
D 50090 402 N	500	370.00	500.00	352	60.00	90.00	3CT 90 402 N	US 0625	HXX 5	CN.. 1204..	US 0613-H25	HXX 2.5	HXX 5	HXX 4	16.63

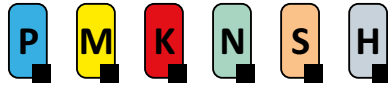
**F75****PRAMET****S****Cabeza de Mandrinar para Acabado, Áng. de Posición 75°, Agujero Pequeño - de Ø24 hasta Ø82 mm**

Cabeza de mandrinado de alto rendimiento de tamaño medio a 75° para acabado. Adecuada para mandrinado de agujeros pasantes y ciegos, achaflanado por interpolación helicoidal y mandrinado con agujeros cruzados. Disponible para utilizar plaquetas tipo CC.. y TC.. y para diámetros de agujero de Ø24 a Ø82 mm con tamaños de mandril de 22 a 42 mm. Alta precisión y repetibilidad.

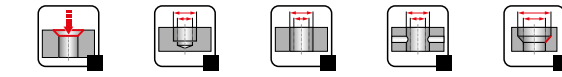
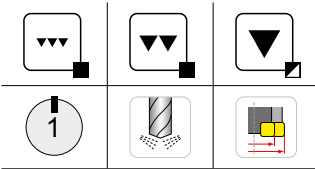
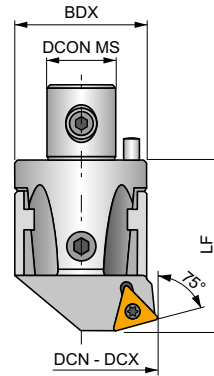

Producto	CZC MS	DCN	DCX	BDX	DCON MS	LF						
		(mm)	(mm)	(mm)	(mm)	(mm)						
A 02275 400	22	24.00	30.00	22	12.00	34.00	CC.. 0602..	US 0206-T08P	SDR T08P	HXK 2	HXK 3	0.10
A 02775 401	27	29.00	40.00	27	15.00	42.00	CC.. 0803..	US 0307-T10P	SDR T10P	HXK 2	HXK 4	0.17
A 02775 409	27	29.00	40.00	27	15.00	42.00	CC.. 09T3..	US 0408-T15P	SDR T15P	HXK 2	HXK 4	0.17
A 03275 401	32	39.00	50.00	32	20.00	45.00	CC.. 0803..	US 0307-T10P	SDR T10P	HXK 2.5	HXK 4	0.26
A 03275 409	32	39.00	50.00	32	20.00	45.00	CC.. 09T3..	US 0408-T15P	SDR T15P	HXK 2.5	HXK 4	0.26
A 04275 300	42	49.00	65.00	42	24.00	56.00	TC.. 16T3..	US 0307-T10P	SDR T10P	HXK 3	HXK 5	0.51
A 05475 300	54	63.00	82.00	54	28.00	66.00	TC.. 16T3..	US 0415-T15P	SDR T15P	HXK 3	HXK 6	1.01



F75-C



PRAMET

S(P)



Cabeza de Mandrinar para Acabado, Áng. de Posición 75°, Agujero Medio - de Ø80 hasta Ø220 mm

Cabeza de mandrinado de alto rendimiento de tamaño medio a 75° para acabado. Adecuada para mandrinado de agujeros pasantes y ciegos, achaflanado por interpolación helicoidal y mandrinado con agujeros cruzados. Disponible para utilizar plaquitas tipo CC .., TC .. o CN .. y para diámetros de agujero de Ø80 a Ø220 mm con tamaños de mandril de 68 a 200 mm. Alta precisión y repetibilidad.

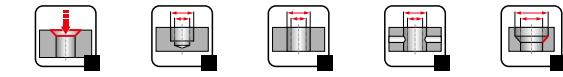
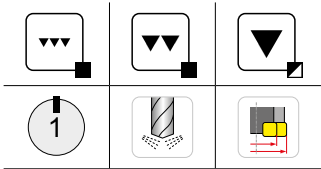
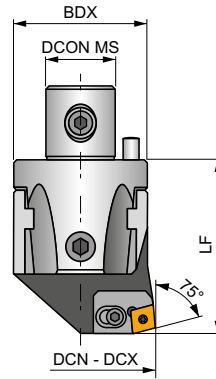

Producto	CZC MS	DCN	DCX	BDX	DCON MS	LF									
		(mm)	(mm)	(mm)	(mm)	(mm)									
A 06875 300	68	80.00	102.00	68	36.00	86.00	2CT 75 300	US 0616	HXK 5	TC.. 16T3..	US 0408-T15P	SDRT15P	HXK 5	HXK 8	2.02
A 06875 402	68	80.00	102.00	68	36.00	86.00	2CT 75 402	US 0616	HXK 5	CC.. 1204..	US 0509-T20P	SDRT20P	HXK 5	HXK 8	2.03
A 06875 402 N	68	80.00	102.00	68	36.00	86.00	2CT 75 402 N	US 0616	HXK 5	CN.. 1204..	US 0613-H25	HXK 2.5	HXK 5	HXK 8	2.04
A 08575 300	85	100.00	125.00	85	50.00	100.00	3CT 75 300	US 0625	HXK 5	TC.. 16T3..	US 0415-T15P	SDRT15P	HXK 6	HXK 8	3.89
A 08575 402	85	100.00	125.00	85	50.00	100.00	3CT 75 402	US 0625	HXK 5	CC.. 1204..	US 0513-T20P	SDRT20P	HXK 6	HXK 8	3.88
A 08575 402 N	85	100.00	125.00	85	50.00	100.00	3CT 75 402 N	US 0625	HXK 5	CN.. 1204..	US 0613-H25	HXK 2.5	HXK 6	HXK 8	3.90
A 10075 300	100	125.00	160.00	110	60.00	100.00	3CT 75 300	US 0625	HXK 5	TC.. 16T3..	US 0415-T15P	SDRT15P	HXK 6	HXK 8	6.22
A 10075 402	100	125.00	160.00	110	60.00	100.00	3CT 75 402	US 0625	HXK 5	CC.. 1204..	US 0513-T20P	SDRT20P	HXK 6	HXK 8	6.24
A 10075 402 N	100	125.00	160.00	110	60.00	100.00	3CT 75 402 N	US 0625	HXK 5	CN.. 1204..	US 0613-H25	HXK 2.5	HXK 6	HXK 8	6.25
A 20075 300	200	160.00	220.00	145	60.00	100.00	3CT 75 300	US 0625	HXK 5	TC.. 16T3..	US 0415-T15P	SDRT15P	HXK 6	HXK 8	8.30
A 20075 402	200	160.00	220.00	145	60.00	100.00	3CT 75 402	US 0625	HXK 5	CC.. 1204..	US 0513-T20P	SDRT20P	HXK 6	HXK 8	8.33
A 20075 402 N	200	160.00	220.00	145	60.00	100.00	3CT 75 402 N	US 0625	HXK 5	CN.. 1204..	US 0613-H25	HXK 2.5	HXK 6	HXK 8	8.33



F75-BB

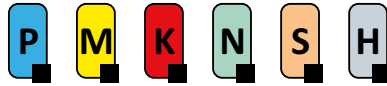

PRAMET

S(P)



Cabeza de Mandrinar para Acabado, Áng. de Posición 75°, Agujero Grande - de Ø220 hasta Ø500 mm

Cabeza de mandrinado de alto rendimiento de tamaño grande a 75° para acabado. Adecuada para mandrinado de agujeros pasantes y ciegos, achaflanado por interpolación helicoidal y mandrinado con agujeros cruzados. Disponible para utilizar plaquitas tipo CC .., TC .. o CN .. y para diámetros de agujero de Ø220 a Ø500 mm con tamaños de mandril de 300 a 500 mm. Alta precisión y repetibilidad.

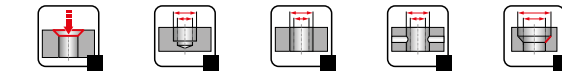
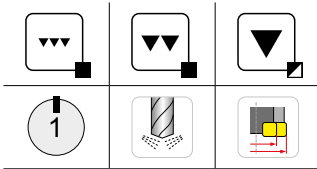
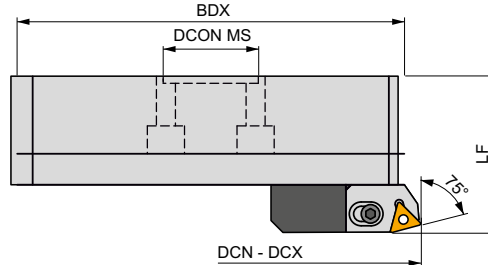

Producto	CZC MS	DCN	DCX	BDX	DCON MS	LF									
		(mm)	(mm)	(mm)	(mm)	(mm)									
A 30075 300	300	220.00	320.00	202	60.00	90.00	3CT 75 300	US 0625	HXK 5	TC.. 16T3..	US 0415-T15P	SDRT15P	HXK 5	HXK 4	8.75
A 30075 402	300	220.00	320.00	202	60.00	90.00	3CT 75 402	US 0625	HXK 5	CC.. 1204..	US 0513-T20P	SDRT20P	HXK 5	HXK 4	8.75
A 30075 402 N	300	220.00	320.00	202	60.00	90.00	3CT 75 402 N	US 0625	HXK 5	CN.. 1204..	US 0613-H25	HXK 2.5	HXK 5	HXK 4	8.30
A 40075 300	400	290.00	400.00	272	60.00	90.00	3CT 75 300	US 0625	HXK 5	TC.. 16T3..	US 0415-T15P	SDRT15P	HXK 5	HXK 4	12.20
A 40075 402	400	290.00	400.00	272	60.00	90.00	3CT 75 402	US 0625	HXK 5	CC.. 1204..	US 0513-T20P	SDRT20P	HXK 5	HXK 4	12.20
A 40075 402 N	400	290.00	400.00	272	60.00	90.00	3CT 75 402 N	US 0625	HXK 5	CN.. 1204..	US 0613-H25	HXK 2.5	HXK 5	HXK 4	12.15
A 50075 300	500	370.00	500.00	352	60.00	90.00	3CT 75 300	US 0625	HXK 5	TC.. 16T3..	US 0415-T15P	SDRT15P	HXK 5	HXK 4	16.31
A 50075 402	500	370.00	500.00	352	60.00	90.00	3CT 75 402	US 0625	HXK 5	CC.. 1204..	US 0513-T20P	SDRT20P	HXK 5	HXK 4	16.31
A 50075 402 N	500	370.00	500.00	352	60.00	90.00	3CT 75 402 N	US 0625	HXK 5	CN.. 1204..	US 0613-H25	HXK 2.5	HXK 5	HXK 4	16.00

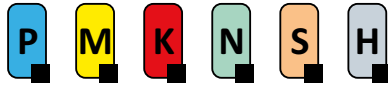
**F90**

PRAMET

S(P)

**Cabeza de Mandrinar para Acabado, Áng. de Posición 90°, Agujero Pequeño - de Ø24 hasta Ø82 mm**

Cabeza de mandrinado de alto rendimiento de tamaño pequeño a 90° para acabado. Adecuada para mandrinado de agujeros pasantes, ciegos y con agujeros cruzados. Disponible para utilizar plaquitas tipo CC .., TC .. o CN .. y para diámetros de agujero de Ø24 a Ø82 mm con tamaños de mandril de 22 a 54 mm. Alta precisión y repetibilidad.

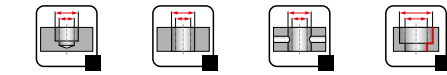
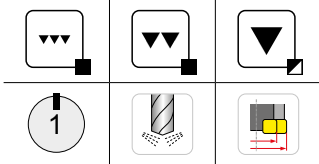
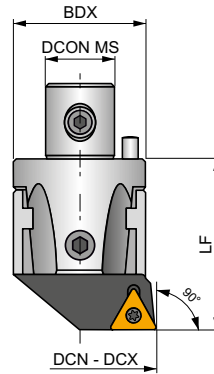

Producto	CZC MS	DCN	DCX	BDX	DCON MS	LF						
		(mm)	(mm)	(mm)	(mm)	(mm)						
A 02290 400	22	24.00	30.00	22	12.00	34.00	CC.. 0602..	US 0206-T08P	SDR T08P	HXK 2	HXK 3	0.10
A 02790 401	27	29.00	40.00	27	15.00	42.00	CC.. 0803..	US 0307-T10P	SDR T10P	HXK 2	HXK 4	0.17
A 02790 409	27	29.00	40.00	27	15.00	42.00	CC.. 09T3..	US 0408-T15P	SDR T15P	HXK 2	HXK 4	0.16
A 03290 300	32	39.00	50.00	32	20.00	45.00	TC.. 16T3..	US 0408-T15P	SDR T15P	HXK 2.5	HXK 4	0.26
A 03290 401	32	39.00	50.00	32	20.00	45.00	CC.. 0803..	US 0206-T08P	SDR T08P	HXK 2.5	HXK 4	0.26
A 03290 409	32	39.00	50.00	32	20.00	45.00	CC.. 09T3..	US 0408-T15P	SDR T15P	HXK 2.5	HXK 4	0.26
A 04290 300	42	49.00	65.00	42	24.00	56.00	TC.. 16T3..	US 0415-T15P	SDR T15P	HXK 3	HXK 5	0.51
A 04290 402	42	49.00	65.00	42	24.00	56.00	CC.. 1204..	US 0513-T20P	SDR T20P	HXK 3	HXK 5	0.51
A 04290 402 N	42	49.00	65.00	42	24.00	56.00	CN.. 1204..	US 0613-H25	HXK 2.5	HXK 3	HXK 5	0.50
A 05490 300	54	63.00	82.00	54	28.00	66.00	TC.. 16T3..	US 0415-T15P	SDR T15P	HXK 3	HXK 6	1.01
A 05490 402	54	63.00	82.00	54	28.00	66.00	CC.. 1204..	US 0513-T20P	SDR T20P	HXK 3	HXK 6	1.03
A 05490 402 N	54	63.00	82.00	54	28.00	66.00	CN.. 1204..	US 0613-H25	HXK 2.5	HXK 3	HXK 6	1.01



F90-C

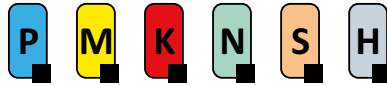

PRAMET

S(P)



Cabeza de Mandrinar para Acabado, Áng. de Posición 90°, Agujero GMedio - de Ø80 hasta Ø220 mm

Cabeza de mandrinado de alto rendimiento de tamaño medio a 90° para acabado. Adecuada para mandrinado de agujeros pasantes, ciegos y con agujeros cruzados. Disponible para utilizar plaquitas tipo CC .., TC .. o CN .. y para diámetros de agujero de Ø80 a Ø220 mm con tamaños de mandril de 68 a 145 mm. Alta precisión y repetibilidad.

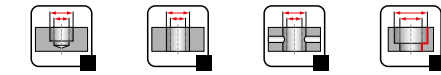
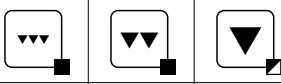
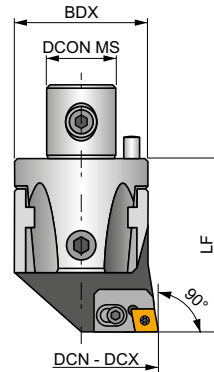

Producto	CZC MS	DCN	DCX	BDX	DCON MS	LF									
		(mm)	(mm)	(mm)	(mm)	(mm)						kg			
A 06890 300	68	80.00	102.00	68	36.00	86.00	2CT 90 300	US 0616	HXX 5	TC.. 16T3..	US 0408-T15P	SDR T15P	HXX 5	HXX 8	2.03
A 06890 402	68	80.00	102.00	68	36.00	86.00	2CT 90 402	US 0616	HXX 5	CC.. 1204..	US 0509-T15P	SDR T15P	HXX 5	HXX 8	2.03
A 06890 402 N	68	80.00	102.00	68	36.00	86.00	2CT 90 402 N	US 0616	HXX 5	CN.. 1204..	US 0613-H25	HXX 2.5	HXX 5	HXX 8	2.60
A 08590 300	85	100.00	125.00	85	50.00	100.00	3CT 90 300	US 0625	HXX 5	TC.. 16T3..	US 0415-T15P	SDR T15P	HXX 6	HXX 8	3.90
A 08590 402	85	100.00	125.00	85	50.00	100.00	3CT 90 402	US 0625	HXX 5	CC.. 1204..	US 0513-T20P	SDR T20P	HXX 6	HXX 8	3.88
A 08590 402 N	85	100.00	125.00	85	50.00	100.00	3CT 90 402 N	US 0625	HXX 5	CN.. 1204..	US 0613-H25	HXX 2.5	HXX 6	HXX 8	4.04
A 10090 300	100	125.00	160.00	100	60.00	100.00	3CT 90 300	US 0625	HXX 5	TC.. 16T3..	US 0415-T15P	SDR T15P	HXX 6	HXX 8	6.24
A 10090 402	100	125.00	160.00	100	60.00	100.00	3CT 90 402	US 0625	HXX 5	CC.. 1204..	US 0513-T20P	SDR T20P	HXX 6	HXX 8	6.24
A 10090 402 N	100	125.00	160.00	100	60.00	100.00	3CT 90 402 N	US 0625	HXX 5	CN.. 1204..	US 0613-H25	HXX 2.5	HXX 6	HXX 8	6.26
A 20090 300	200	160.00	220.00	145	60.00	100.00	3CT 90 300	US 0625	HXX 5	TC.. 16T3..	US 0415-T15P	SDR T15P	HXX 6	HXX 8	8.30
A 20090 402	200	160.00	220.00	145	60.00	100.00	3CT 90 402	US 0625	HXX 5	CC.. 1204..	US 0513-T20P	SDR T20P	HXX 6	HXX 8	8.29
A 20090 402 N	200	160.00	220.00	145	60.00	100.00	3CT 90 402 N	US 0625	HXX 5	CN.. 1204..	US 0613-H25	HXX 2.5	HXX 6	HXX 8	8.33



F90-BB

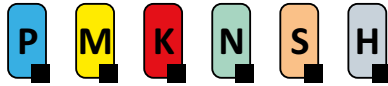

PRAMET

S(P)



Cabeza de Mandrinar para Acabado, Áng. de Posición 90°, Agujero Grande - de Ø220 hasta Ø500 mm

Cabeza de mandrinado de alto rendimiento de tamaño grande a 90° para acabado. Adecuada para mandrinado de agujeros pasantes, ciegos y con agujeros cruzados. Disponible para utilizar plaquitas tipo CC .., TC .. o CN .. y para diámetros de agujero de Ø220 a Ø500 mm con tamaños de mandril de 202 a 352 mm. Alta precisión y repetibilidad.

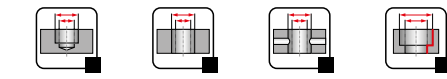
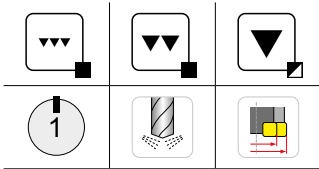
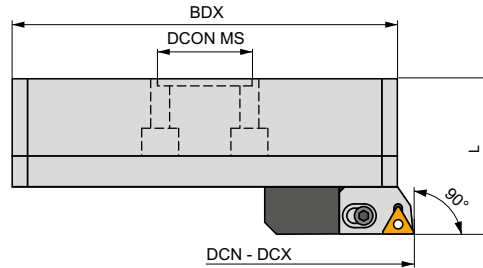

Producto	CZC MS	DCN	DCX	BDX	DCON MS	LF													
		(mm)	(mm)	(mm)	(mm)	(mm)													
A 30090 300	300	220.00	320.00	202	60.00	90.00	3CT 90 300	US 0625	HXK 5	TC.. 16T3..	US 0415-T15P	SDRT15P	HXK 5	HXK 4	8.74				
A 30090 402	300	220.00	320.00	202	60.00	90.00	3CT 90 402	US 0625	HXK 5	CC.. 1204..	US 0513-T20P	SDRT20P	HXK 5	HXK 4	8.82				
A 30090 402 N	300	220.00	320.00	202	60.00	90.00	3CT 90 402 N	US 0625	HXK 5	CN.. 1204..	US 0613-H25	HXK 2.5	HXK 5	HXK 4	8.75				
A 40090 300	400	290.00	400.00	272	60.00	90.00	3CT 90 300	US 0625	HXK 5	TC.. 16T3..	US 0415-T15P	SDRT15P	HXK 5	HXK 4	12.19				
A 40090 402	400	290.00	400.00	272	60.00	90.00	3CT 90 402	US 0625	HXK 5	CC.. 1204..	US 0513-T20P	SDRT20P	HXK 5	HXK 4	12.50				
A 40090 402 N	400	290.00	400.00	272	60.00	90.00	3CT 90 402 N	US 0625	HXK 5	CN.. 1204..	US 0613-H25	HXK 2.5	HXK 5	HXK 4	12.20				
A 50090 300	500	370.00	500.00	352	60.00	90.00	3CT 90 300	US 0625	HXK 5	TC.. 16T3..	US 0415-T15P	SDRT15P	HXK 5	HXK 4	16.08				
A 50090 402	500	370.00	500.00	352	60.00	90.00	3CT 90 402	US 0625	HXK 5	CC.. 1204..	US 0513-T20P	SDRT20P	HXK 5	HXK 4	16.20				
A 50090 402 N	500	370.00	500.00	352	60.00	90.00	3CT 90 402 N	US 0625	HXK 5	CN.. 1204..	US 0613-H25	HXK 2.5	HXK 5	HXK 4	16.00				



MB-H

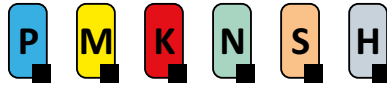

PRAMET

S



Micro Cabeza de Mandrinar, para Agujero Muy Pequeño - Ø8 a Ø38 mm

Micro cabeza de mandrinado de alto rendimiento y alta precisión con alta repetibilidad. Adecuado para agujeros pasantes, ciegos, transversales y refrentados. El tamaño de la cabeza puede llevar herramientas de mandrinar desde Ø6,0 hasta Ø16,0 mm. Disponible en tamaños desde 27 hasta 42 mm.

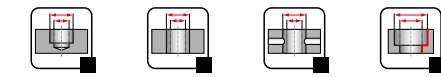
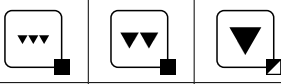
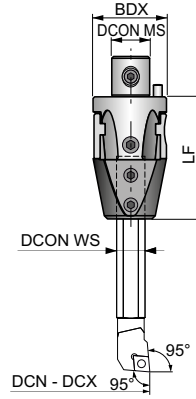

Producto	CZC MS	DCN	DCX	BDX	DCON MS	DCON WS	LB			
		(mm)	(mm)	(mm)	(mm)	(mm)				
A 027 006	27	8.00	20.00	27	15.00	6.00	50.00	HXX 2	HXX 4	0.20
A 027 008	27	10.00	21.00	27	15.00	8.00	50.00	HXX 2	HXX 4	0.19
A 032 008	32	10.00	21.00	32	20.00	8.00	58.00	HXX 2.5	HXX 4	0.32
A 032 010	32	13.00	25.00	32	20.00	10.00	58.00	HXX 2.5	HXX 4	0.32
A 042 010	42	13.00	29.00	42	24.00	10.00	70.00	HXX 3	HXX 5	0.64
A 042 012	42	16.00	34.00	42	24.00	12.00	70.00	HXX 3	HXX 5	0.64
A 042 016	42	20.00	38.00	42	24.00	16.00	70.00	HXX 3	HXX 5	0.62



ISO BARS





PRAMET

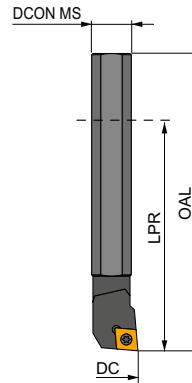

Barra de Mandrinar para Micro Cabezas de Mandrinar, Diámetro de Mango de Ø6 a Ø16 mm

Adecuadas para mandrinar agujeros ciegos, pasantes, transversales y con agujeros cruzados. Disponibles para plaquitas tipo EP .., TC .. y CC ...



Producto	DCON MS (mm)	DC (mm)	OAL (mm)	LPR (mm)				Carbide	
S06E SELPR 05-B	6.00	8.00	70.0	46	EP.. 0502..	US 0205-T07P	SDR T07P	–	0.04
S08F SCLCR 06-B	8.00	10.00	80.0	50	CC.. 0602..	US 0205-T08P	SDR T08P	–	0.04
S10G SCLCR 06-B	10.00	13.00	90.0	54	CC.. 0602..	US 0206-T08P	SDR T08P	–	0.06
S12H SCLCR 06-B	12.00	16.00	100.0	64	CC.. 0602..	US 0206-T08P	SDR T08P	–	0.11
S16J SCLCR 09-B	16.00	20.00	110.0	74	CC.. 09T3..	US 0408-T15P	SDR T15P	–	0.18
S16J STFCR 09-B	16.00	20.00	110.0	74	TC.. 0902..	US 0206-T07P	SDR T07P	–	0.18
S16J STFCR 16-B	16.00	20.00	110.0	74	TC.. 16T3..	US 0408-T15P	SDR T15P	–	0.18
C08G SCLCR 06	8.00	10.00	90.0	60	CC.. 0602..	US 0205-T08P	SDR T08P	✓	1.00
C10J SCLCR 06	10.00	13.00	110.0	74	CC.. 0602..	US 0206-T08P	SDR T08P	✓	0.13
C12K SCLCR 06	12.00	16.00	125.0	89	CC.. 0602..	US 0206-T08P	SDR T08P	✓	0.20
C16L SCLCR 09	16.00	20.00	140.0	104	CC.. 09T3..	US 0408-T15P	SDR T15P	✓	0.38



ISO BARS A042



Barras de Mandrinar para Micro Cabezas de Mandrinado A042

Barras de mandrinar con mango sobredimensionado $\varnothing 16$ mm. Adecuadas para mandrinar agujeros ciegos, pasantes y con agujeros cruzados. Disponibles para plaquitas tipo EP .., TC .. y CC ...

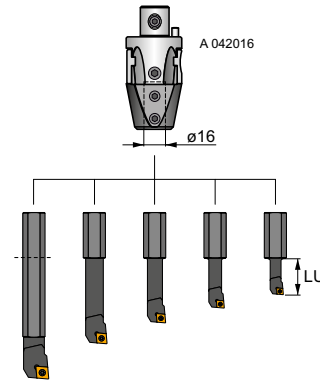

Producto	DCN (mm)	DCX (mm)	LU (mm)				
S06/16 SELPR 05	8.00	26.00	25.00	EP.. 0502..	US 0205-T07P	SDR T07P	0.08
S06/16 STFCR 06	8.00	26.00	25.00	TC.. 06T1..	US 0405-T06P	SDR T06P	0.08
S08/16 SCLCR 06	10.00	28.00	35.00	CC.. 0602..	US 0205-T08P	SDR T08P	0.09
S08/16 STFCR 06	10.00	28.00	35.00	TC.. 06T1..	US 0405-T06P	SDR T06P	0.07
S10/16 SCLCR 06	13.00	31.00	45.00	CC.. 0602..	US 0206-T08P	SDR T08P	0.10
S10/16 STFCR 09	13.00	31.00	45.00	TC.. 0902..	US 0206-T07P	SDR T07P	0.10
S12/16 SCLCR 06	16.00	34.00	57.00	CC.. 0602..	US 0206-T08P	SDR T08P	0.13
S12/16 STFCR 09	16.00	34.00	57.00	TC.. 0902..	US 0206-T07P	SDR T07P	0.13
S16/16 SCLCR 09	20.00	38.00	73.00	CC.. 09T3..	US 0408-T15P	SDR T15P	0.18
S16/16 STFCR 09	20.00	38.00	73.00	TC.. 0902..	US 0206-T07P	SDR T07P	0.18
S16/16 STFCR 16	20.00	38.00	73.00	TC.. 0902..	US 0408-T15P	SDR T15P	0.18



ACCESORIOS



DESCRIPCIÓN DE CARTUCHOS

1	2	3	4
2CT	90	402 N	S

1	2	3	4
Tipo de herramienta	Ángulo de posición	Código de asiento de plaquita	Variante
2CT	30	300 TC..16T3.	S Escalonado
3CT	45	402 CC..1204..	
	75	402N CN..1204..	
	90		



Mandrinado simétrico

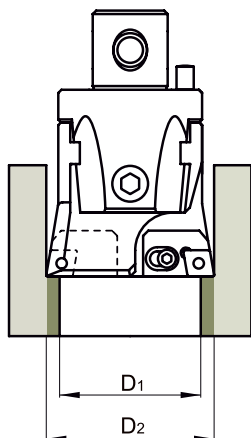

2CT □□ □□□ + 2CT □□ □□□
 3CT □□ □□□ + 3CT □□ □□□

Mandrinado escalonado

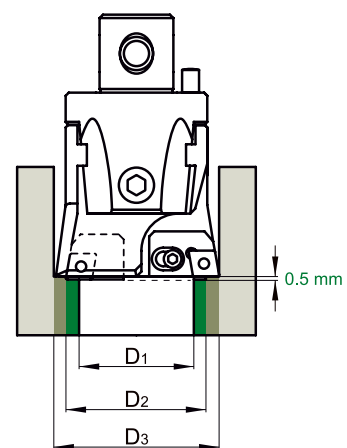

2CT □□ □□□ S + 2CT □□ □□□
 3CT □□ □□□ S + 3CT □□ □□□



CART-BS-SPC

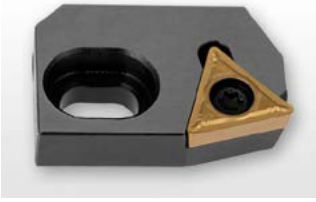
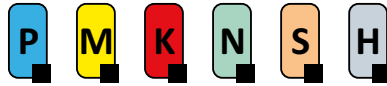

Cartucho Especial para Cabezas de Mandrinar 2CT y 3CT

Cartuchos para cabezas de mandrinar especiales, tamaños 2CT y 3CT disponibles en diferentes ángulos de posición 30° o 45°. Adecuados para montar plaquitas TC ..., CC ..., CN ... para aplicaciones de mandrinado en desbaste y acabado.

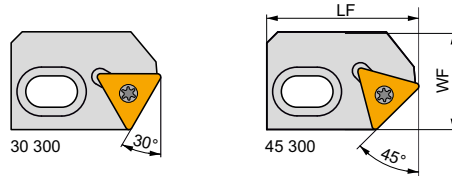

Producto	WF (mm)	LF (mm)									
2CT 30 300	22.5	35.00	US 0616	HXK 5	US 0430	HXK 2	TC.. 16T3..	US 0408-T15P	SDR T15P	0.59	
2CT 45 300	22.5	35.00	US 0616	HXK 5	US 0430	HXK 2	TC.. 16T3..	US 0408-T15P	SDR T15P	0.05	
2CT 90 300 S	23	33.00	US 0616	HXK 5	US 0430	HXK 2	TC.. 16T3..	US 0408-T15P	SDR T15P	0.05	
2CT 90 402 N S	23	33.00	US 0616	HXK 5	US 0430	HXK 2	CN.. 1204.. L	US 0613-H25	HXK 2.5	0.07	
2CT 90 402 S	23	33.00	US 0616	HXK 5	US 0430	HXK 2	CC.. 1204..	US 0509-T20P	SDR T20P	0.05	
3CT 30 300	28	39.00	US 0625	HXK 5	US 0635	HXK 3	TC.. 16T3..	US 0415-T15P	SDR T15P	0.10	
3CT 45 300	28	39.00	US 0625	HXK 5	US 0635	HXK 3	TC.. 16T3..	US 0415-T15P	SDR T15P	0.10	
3CT 90 300 S	28.5	37.00	US 0625	HXK 5	US 0635	HXK 3	TC.. 16T3..	US 0415-T15P	SDR T15P	0.10	
3CT 90 402 N S	28.5	37.00	US 0625	HXK 5	US 0635	HXK 3	CN.. 1204.. L	US 0613-H25	HXK 2.5	0.11	
3CT 90 402 S	28.5	37.00	US 0625	HXK 5	US 0635	HXK 3	CC.. 1204..	US 0513-T20P	SDR T20P	0.09	



CART-BS-STD

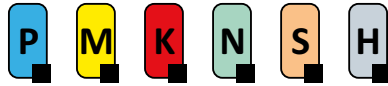

Cartucho Estándar para Cabezas de Mandrinar 2CT y 3CT

Cartuchos para cabezas de mandrinar especiales, tamaños 2CT y 3CT disponibles en diferentes ángulos de posición 75° o 90°. Adecuados para montar plaquitas TC ..., CC ..., CN ... para aplicaciones de mandrinado en desbaste y acabado.

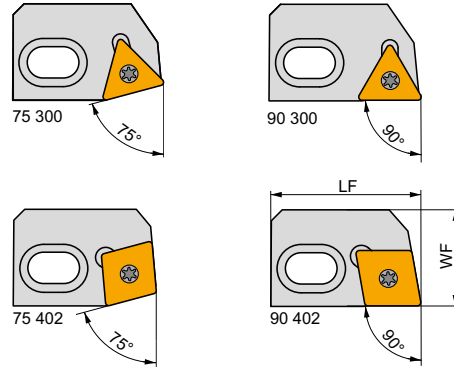

Producto	WF (mm)	LF (mm)									
2CT 75 300	22.5	35.00	US 0616	HXK 5	US 0430	HXK 2	TC.. 16T3..	US 0408-T15P	SDR T15P	0.06	
2CT 75 402	22.5	35.00	US 0616	HXK 5	US 0430	HXK 2	CC.. 1204..	US 0509-T20P	SDR T20P	0.06	
2CT 75 402 N	22.5	35.00	US 0616	HXK 5	US 0430	HXK 2	CN.. 1204.. R	US 0613-H25	HXK 2.5	0.07	
2CT 90 300	22.5	35.00	US 0616	HXK 5	US 0430	HXK 2	TC.. 16T3..	US 0408-T15P	SDR T15P	0.05	
2CT 90 402	22.5	35.00	US 0616	HXK 5	US 0430	HXK 2	CC.. 1204..	US 0509-T20P	SDR T20P	0.05	
2CT 90 402 N	22.5	35.00	US 0616	HXK 5	US 0430	HXK 2	CN.. 1204.. L	US 0613-H25	HXK 2.5	0.07	
3CT 75 300	28	39.00	US 0625	HXK 5	US 0635	HXK 3	TC.. 16T3..	US 0415-T15P	SDR T15P	0.10	
3CT 75 402	28	39.00	US 0625	HXK 5	US 0635	HXK 3	CC.. 1204..	US 0509-T20P	SDR T20P	0.10	
3CT 75 402 N	28	39.00	US 0625	HXK 5	US 0635	HXK 3	CN.. 1204.. R	US 0613-H25	HXK 2.5	0.12	
3CT 90 300	28	39.00	US 0625	HXK 5	US 0635	HXK 3	TC.. 16T3..	US 0415-T15P	SDR T15P	0.11	
3CT 90 402	28	39.00	US 0625	HXK 5	US 0635	HXK 3	CC.. 1204..	US 0509-T20P	SDR T20P	0.10	
3CT 90 402 N	28	39.00	US 0625	HXK 5	US 0635	HXK 3	CN.. 1204.. L	US 0613-H25	HXK 2.5	0.12	



CHAM-BS

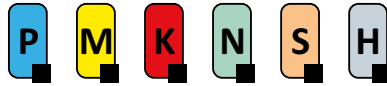

PRAMET

S



Anillo de Achaflanar CH-BS para Cabezas de Mandrinar

Anillo de achaflanado a 45° para cabezas de mandrinar, tamaños de 22 a 42 mm para montar plaquitas DC.. 11T3 .., y tamaños de 54 a 200 mm para montar plaquitas DC.. 1504 ...

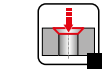
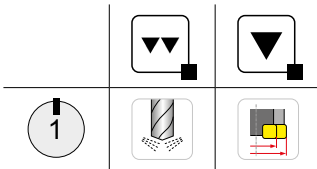
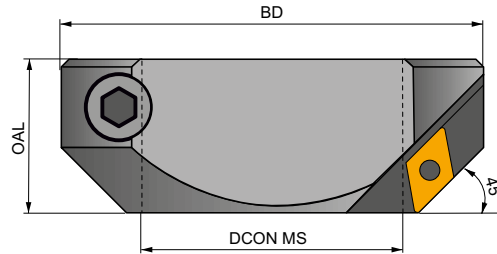

















Producto	CZC MS	DCON MS	BD	OAL					
		(mm)	(mm)	(mm)					
CH 022	22	22.00	43.00	24.0	DC.. 11T3..	US 0408-T15P	SDRT15P	HXX 4	0.11
CH 027	27	27.00	48.00	24.0	DC.. 11T3..	US 0408-T15P	SDRT15P	HXX 4	0.13
CH 032	32	32.00	62.00	30.0	DC.. 11T3..	US 0408-T15P	SDRT15P	HXX 5	0.29
CH 042	42	42.00	72.00	30.0	DC.. 11T3..	US 0408-T15P	SDRT15P	HXX 5	0.38
CH 054	54	54.00	94.00	40.0	DC.. 1504..	US 0513-T20P	SDRT20P	HXX 6	0.89
CH 068	68	68.00	110.00	40.0	DC.. 1504..	US 0513-T20P	SDRT20P	HXX 8	1.23
CH 085	85	85.00	145.00	55.0	DC.. 1504..	US 0513-T20P	SDRT20P	HXX 10	2.70
CH 100	100	100.00	170.00	60.0	DC.. 1504..	US 0513-T20P	SDRT20P	HXX 14	4.14
CH 200	200	100.00	200.00	60.0	DC.. 1504..	US 0513-T20P	SDRT20P	HXX 14	5.80



PLAQUITAS DE CORTE PARA MANDRILADO





PLAQUITAS DE CORTE PARA MANDRILADO: NAVEGADOR

CCGT  388	CCGW CBN  390	CCMT  390	CCMW  393
CNGA CBN  394	CNGG  395	CNMA  395	CNMG  396
DCMT  398	DCMW  399	DCMW PCD  399	
EPGX  400	EPMT  400		
TCGT  401	TCMT  402	TCMW  403	

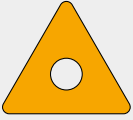
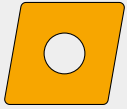

PLAQUITAS DE CORTE INTERCAMBIABLES

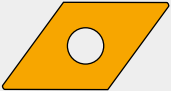
Forma	Denominación del alojamiento	Código ISO
	300	TC..16T3..
	400 401 402 409	CC..0602.. CC..0803.. CC..1204.. CC..09T3..
	402N	CN..1204..
		EP..0502..
		DC..11T3.. DC..1504..

Se pueden encontrar más opciones de plaquitas en la parte de producto de Torneado. Los detalles de sus geometrías se encuentran también en Torneado.



CALIDADES DE MANDRINADO: NAVEGADOR

Identificación de la calidad	Área de aplicación	Aplicación	Avance	Velocidad de corte	Resistencia a condiciones de trabajo adversas	Recubrimiento	Color	Sustrato	Ventajas del refrigerante	Descripción de la calidad
T9315	P05 - P25	■				MT-CVD		FGM	++	Una calidad versátil con una excelente resistencia al desgaste, incluso con condiciones de corte intensivas. También se puede utilizar para operaciones con cortes interrumpidos. Gracias a sus propiedades bien equilibradas, esta calidad constituye la mejor opción para una amplia variedad de operaciones de torneado. No se recomienda para velocidades de corte bajas.
	K05 - K25	■								
	H10 - H20	■								
T9325	P15 - P35	■				MT-CVD		FGM	++	Desde el punto de vista tecnológico, se trata de una calidad extremadamente versátil con una elevada resistencia a los daños mecánicos en condiciones de corte adversas y ofrece una excelente resistencia al desgaste. El uso correcto de este material requiere altas velocidades de corte.
	M10 - M30	■								
	K15 - K35	■								
	S10 - S20	■								
T9335	P20 - P45	■				MT-CVD		FGM	+++	Una de las calidades más resistentes, especialmente adecuada para condiciones de corte adversas a velocidades de avance y de corte medias. En comparación con sus predecesores, M15-M40 no solo es más resistente, sino que también es más estable a la abrasión, lo que será útil cuando se utilice en condiciones de corte intensivas.
	M15 - M40	■								
	S15 - S25	■								
T7325	P15 - P35	■				MT-CVD		FGM	+++	Una de las calidades de torneado más universales. Es especialmente adecuada para el mecanizado de acero inoxidable. Presenta un equilibrio óptimo entre resistencia al desgaste y fiabilidad de funcionamiento. Adecuada para una amplia variedad de aplicaciones en operaciones de torneado.
	M10 - M25	■								
	S10 - S25	■								
T7335	P20 - P40	■				MT-CVD		FGM	+++	Calidad con un sustrato funcionalmente graduado, que se caracteriza por una fiabilidad de funcionamiento muy alta y una muy buena resistencia al desgaste. Es la más adecuada para el mecanizado de materiales muy resistentes M20-M40.
	M20 - M40	■								
	S15 - S25	■								
T5305	P05 - P15	■				MT-CVD		H	+	Calidad con una elevada resistencia al desgaste químico; es adecuada para operaciones de acabado a elevadas velocidades de corte. Gracias a su alta resistencia a la abrasión, también es adecuada para el mecanizado productivo K01-K15 de materiales endurecidos y tratados.
	K01 - K15	■								
	H05 - H15	■								
T5315	P10 - P25	■				MT-CVD		H	+	Calidad destinada principalmente al mecanizado productivo, caracterizada por una gran resistencia a la abrasión y una buena fiabilidad de funcionamiento. Debido a sus propiedades, este material es particularmente adecuado para operaciones de acabado y de desbaste con condiciones de corte buenas o ligeramente adversas.
	K10 - K25	■								
	H15 - H25	■								
T8315	P05 - P20	■				PVD		submicron H	++	Calidad que presenta una excelente resistencia a la abrasión, a la vez que mantiene una fiabilidad de funcionamiento superior a la media; es adecuada para el mecanizado a velocidades de corte medias y altas en materiales duros de viruta corta.
	M05 - M20	■								
	K05 - K25	■								
	N05 - N25	■								
	S05 - S15	■								
T8330	P25 - P40	■				PVD		submicron H	+++	Sin duda, el material de corte más versátil; resulta idóneo para el mecanizado de todo tipo de materiales mecanizados y es prácticamente aplicable en casi todos los tipos de operaciones de torneado. Sus principales ventajas son su elevada fiabilidad de funcionamiento y sus excelentes propiedades de fricción; por lo que es adecuado para aplicaciones a velocidades de corte medias y bajas.
	M20 - M35	■								
	K20 - K40	■								
	N15 - N30	■								
	S15 - S25	■								
T6310	P01 - P15	■				PVD		ultra submicron H	+++	Calidad de torneado altamente resistente al desgaste con recubrimiento superior de PVD. Resulta ideal para operaciones y aplicaciones de acabado donde es de gran importancia contar con un filo de corte afilado y una gran resistencia al desgaste en flanco.
	M01 - M15	■								
	K05 - K20	■								
	N05 - N20	■								
	S01 - S15	■								
H01 - H15	■									



CALIDADES DE MANDRINADO: NAVEGADOR

Identificación de la calidad	Área de aplicación	Aplicación	Avance	Velocidad de corte	Resistencia a condiciones de trabajo adversas	Recubrimiento	Color	Sustrato	Ventajas del refrigerante	Descripción de la calidad
T0315	N05 - N20	■				PVD			++	Calidad submicrón para el torneado de materiales no féreos y sus aleaciones con un buen equilibrio entre resistencia al desgaste y tenacidad. Cuenta con un recubrimiento único con excelentes propiedades de fricción.
HF7	M10 - M20	■				×		submicron H	++	Calidad sin recubrimiento diseñada fundamentalmente para el mecanizado de materiales no féreos; pero también se puede utilizar para otros materiales mecanizados (excepto acero). Este material puede utilizarse en el torneado, el fresado e incluso el mandrilado.
	K10 - K25	■								
	N10 - N25	■								
H07	M05 - M15	■				×		submicron H	++	Calidad de torneado sin recubrimiento, adecuada para aplicaciones de mecanizado donde la resistencia a la oxidación no es el criterio determinante para la vida útil de la herramienta. Diseñada para el mecanizado de aleaciones con base de Ti. Esta calidad presenta una alta resistencia del filo de corte, junto con una buena resistencia al desgaste.
	K10 - K25	■								
	N10 - N30	■								
	S01 - S20	■								
TT310	P10 - P25	■				PVD		cermet	+ / -	Cermet con recubrimiento, que se utiliza para el torneado fino y de acabado de aceros al carbono y aleados (incluidos los inoxidable). Sus excelentes propiedades mejoran aún más gracias al recubrimiento aplicado mediante la técnica de PVD.
	M15 - M25	■								
TT010	P01 - P10	■				×		cermet	+ / -	Cermet sin recubrimiento, adecuado para el mecanizado fino de todo tipo de aceros (incluido el inoxidable) a velocidades de avance muy bajas. Su principal ventaja es el radio mínimo del filo de corte y su alta resistencia a los mecanismos de desgaste físico y químico.
	M01 - M10	■								
PD1	N05 - N25	■				×		PCD	-	Calidad PCD para el torneado de materiales no féreos. Es la elección ideal para trabajar a elevadas velocidades de corte y avances lentos con condiciones estables.
TB310	K01 - K10	■				×		CBN	--	La calidad CBN es adecuada para el mecanizado de materiales endurecidos. Adecuada para el mecanizado a elevadas velocidades de corte y avances lentos con condiciones estables.
	S05 - S10	■								
	H01 - H10	■								

Sustrato	
H	Sustrato de base WC-Co
submicron H	Sustrato de base WC-Co de grano fino (< 1 µm)
ultra submicron H	Sustrato de base WC-Co de grano muy fino (< 0,5 µm)
FGM	Sustrato de grado funcional
Cermet	Carburo sin WC
PCD	Diamante policristalino
CBN	Nitruro de Boro Cúbico

Recubrimiento	
MT-CVD	Método de recubrimiento químico a media temperatura
PVD	Metodo de recubrimiento físico
×	Sin recubrimiento

Ventajas del refrigerante	
+++	Uso esencial de refrigerante
++	Muy recomendado
+ / -	Opcional
--	No utilizar refrigerante



PLAQUITAS – DESIGNACIÓN CÓDIGO ISO

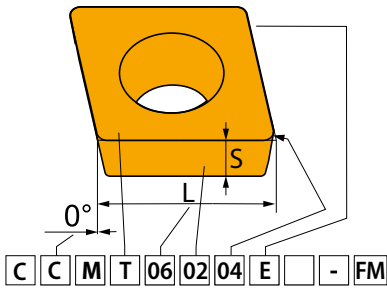

ISO	1	2	3	4
	C	C	M	T
ANSI	1	2	3	4
	C	C	M	T

1				2				4															
Forma de plaquita				Ángulo de incidencia				Tipo de plaquita															
H	O	P	R	A	B	C	D	N	R	F	A	M	G	W	T	Q	U	B	H	C	J	X	
S	T	C	D	E	F	G	N	B	H	C	J	Q	U	B	H	C	J	X	X	Q	U	B	H
E	M	V	W	P	O		Especial																
L	A	B	K																				

3 Tolerancias

	(mm)			(")		
	M(±)	S(±)	IC(±)	M(±)	S(±)	IC(±)
A	0.005	0.025	0.025	.0002"	.001"	.0010"
F	0.005	0.025	0.013	.0002"	.001"	.0005"
C	0.013	0.025	0.025	.0005"	.001"	.0010"
H	0.013	0.025	0.013	.0005"	.001"	.0005"
E	0.025	0.025	0.025	.0010"	.001"	.0010"
G	0.025	0.130	0.025	.0010"	.005"	.0010"
J	0.005	0.025	0.05 – 0.13	.0002"	.001"	.002 – 0.005"
K	0.013	0.025	0.05 – 0.13	.0005"	.001"	.002 – 0.005"
L	0.025	0.025	0.05 – 0.13	.0010"	.001"	.002 – 0.005"
M	0.08 – 0.18	0.130	0.05 – 0.13	.003 – 0.007"	.005"	.002 – 0.005"
N	0.08 – 0.18	0.025	0.05 – 0.13	.003 – 0.007"	.001"	.002 – 0.005"
U	0.05 – 0.38	0.130	0.05 – 0.13	.005 – 0.015"	.005"	.003 – 0.010"

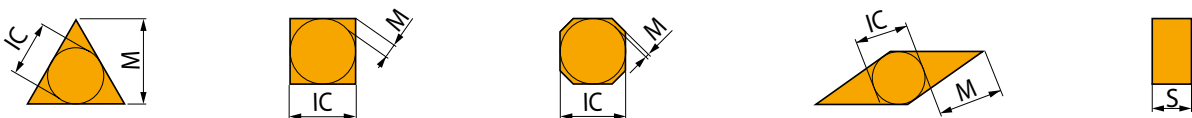



PLAQUITAS – DESIGNACIÓN CÓDIGO ISO

5	6	7	8	9	10
06	02	04	E	-	FM
5	6	7	8	9	10
2	1.5	1	E	-	FM

5		5												
Longitud del filo de corte (tamaño de plaqueta)														
d = IC		H	O	P	S	T	C	D	E	M	V	W	R	K
(mm)	(in)													
3.97	5/32"				03	06		04			06	02		
4.76	3/16"				04	08	04	05	04	04	08	L3		
5.56	7/32"				05	09	05	06	05	05	09	03		
6.35	1/4"	03	02	04	08	11	06	07	08	08	11	04	06	
7.94	5/16"	04	03	05	07	13	08	09	06	07	13	05	07	
9.525	3/8"	05	04	07	09	16	09	11	09	09	16	06	09	16
12.7	1/2"	07	05	09	12	22	12	15	13	12	22	08	12	
15.875	5/8"	09	06	11	15	27	16	19	16	15	27	10	15	
19.05	3/4"	11	07	13	19	33	19	23	19	19	33	13	19	
25.40	1"	14	10	18	25	44	25	31	26	25	44	17	25	
31.75	1 1/4"	18	13	23	31	54	32	38	32	31	54	21	31	

6		7	
Espesor		Radio de punta	
	S		RE
	(mm)	(mm)	(")
01	1.59	0	0"
T1	1.98	0.2	1/128"
02	2.38	0.4	1/64"
03	3.18	0.8	1/32"
04	3.97	1.2	3/64"
05	4.76	1.6	1/16"
06	5.56	2.4	3/32"
07	7.94	3.2	1/8"
09	9.52		

5		5	
Longitud del filo de corte (tamaño de plaqueta)			
d = I.C.		RE	
(mm)	(in)	(mm)	(")
00	0	0	0"
02	0.2	1/128"	
04	0.4	1/64"	
08	0.8	1/32"	
12	1.2	3/64"	
16	1.6	1/16"	
24	2.4	3/32"	
32	3.2	1/8"	
Plaquitas redondas			
d = I.C.			
(")		00	
(mm)		M0	

ANSI					
5		6		7	
Círculo inscrito		Espesor		Radio de punta	
Symbol		Symbol		Symbol	
d = I.C.		S		RE	
(mm)	(")	(mm)	(")	(mm)	(")
1	3.175	1	1.588	0	0
1.2	3.969	1.2	1.984	0.2	0.099
1.5	4.763	1.5	2.381	0.5	0.198
1.8	5.556	2	3.175	1	0.397
2	6.350	2.5	3.969	2	0.794
2.5	7.938	3	4.763	3	1.191
3	9.525	3.5	5.556	4	1.588
4	12.700	4	6.350	5	1.984
5	15.875	5	7.938	6	2.381
6	19.050	6	9.525	7	2.778
7	22.225	7	11.113	8	3.175
8	25.400	8	12.700	10	3.969
10	31.750	9	14.288	12	4.763
12	38.100	10	15.875	14	5.556
				16	6.350

8		8	
Condición del filo de corte			
	Filos vivos		Filos redondeados
	Filos con faceta		Filo redondeado con faceta
	Filos con doble faceta		Filos redondeados con doble faceta
9		9	
Dirección de avance			
R		N	
L			
10		10	
Designación del rompevirutas			



CCGT



	IC	D1	L	S
	(mm)	(mm)	(mm)	(mm)
0602	6.350	2.80	6.40	2.38
0602-SF3	6.350	2.80	6.40	2.58
0803-AL	7.940	3.40	8.10	3.43
0803-SF3	7.940	3.40	8.10	3.43
09T3	9.525	4.40	9.70	3.97
09T3-SF3	9.525	4.40	9.70	4.22
1204	12.700	5.50	12.90	4.76
1204-SF3	12.700	5.50	12.90	5.01

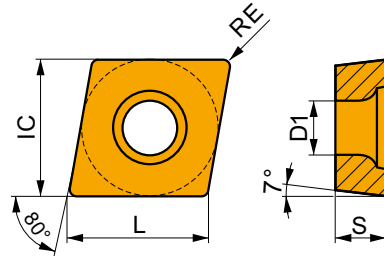

Valores de inicio adecuados para la velocidad de corte (vc), avance (f) y profundidad de corte (ap). Consulte nuestra APP Calculadora de mecanizado para obtener más cálculos.

Producto	RE	P			M			K			N			S			H		
		vc	f	ap	vc	f	ap	vc	f	ap	vc	f	ap	vc	f	ap	vc	f	ap
	(mm)	(m/min)	(mm/rev)	(mm)	(m/min)	(mm/rev)	(mm)	(m/min)	(mm/rev)	(mm)	(m/min)	(mm/rev)	(mm)	(m/min)	(mm/rev)	(mm)	(m/min)	(mm/rev)	(mm)



Geometría AL con un diseño muy positivo para operaciones de acabado fino a desbaste, con corte continuo y ligeramente interrumpido.

CCGT 060202F-AL	HF7	0.2	-	-	-	-	-	-	-	-	-	360	0.12	1.0	-	-	-	-	-	-
	T0315	0.2	-	-	-	-	-	-	-	-	-	360	0.12	1.0	-	-	-	-	-	-
CCGT 060204F-AL	HF7	0.4	-	-	-	-	-	-	-	-	-	300	0.24	1.0	-	-	-	-	-	-
	T0315	0.4	-	-	-	-	-	-	-	-	-	300	0.24	1.0	-	-	-	-	-	-
CCGT 080302F-AL	T0315	0.2	-	-	-	-	-	-	-	-	-	360	0.12	1.0	-	-	-	-	-	-
CCGT 080304F-AL	HF7	0.4	-	-	-	-	-	-	-	-	-	300	0.24	1.0	-	-	-	-	-	-
	T0315	0.4	-	-	-	-	-	-	-	-	-	300	0.24	1.0	-	-	-	-	-	-
CCGT 09T302F-AL	HF7	0.2	-	-	-	-	-	-	-	-	-	360	0.12	1.0	-	-	-	-	-	-
	T0315	0.2	-	-	-	-	-	-	-	-	-	360	0.12	1.0	-	-	-	-	-	-
CCGT 09T304F-AL	HF7	0.4	-	-	-	-	-	-	-	-	-	300	0.24	1.5	-	-	-	-	-	-
	T0315	0.4	-	-	-	-	-	-	-	-	-	300	0.24	1.5	-	-	-	-	-	-
CCGT 09T308F-AL	HF7	0.8	-	-	-	-	-	-	-	-	-	200	0.48	1.5	-	-	-	-	-	-
	T0315	0.8	-	-	-	-	-	-	-	-	-	200	0.48	1.5	-	-	-	-	-	-
CCGT 120404F-AL	HF7	0.4	-	-	-	-	-	-	-	-	-	300	0.24	2.4	-	-	-	-	-	-
	T0315	0.4	-	-	-	-	-	-	-	-	-	300	0.24	2.4	-	-	-	-	-	-
CCGT 120408F-AL	HF7	0.8	-	-	-	-	-	-	-	-	-	200	0.48	2.4	-	-	-	-	-	-
	T0315	0.8	-	-	-	-	-	-	-	-	-	200	0.48	2.4	-	-	-	-	-	-

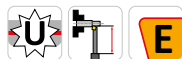
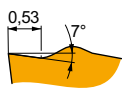

Geometría FF2 con un diseño muy positivo para operaciones de acabado y acabado fino con corte continuo y ligeramente interrumpido.

CCGT 09T302E-FF2	T7325	0.2	150	0.05	1.0	-	-	-	-	-	-	-	-	-	-	-	-	-	-	-
	T9325	0.2	150	0.05	1.0	-	-	-	115	0.05	1.0	-	-	-	-	-	-	-	-	-

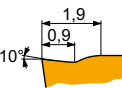

Geometría NF1 con diseño positivo para acabado fino a mecanizado medio con corte continuo.

CCGT 060204E-NF1	T6310	0.4	140	0.10	0.8	110	0.09	0.8	-	-	-	360	0.12	0.8	38	0.07	0.6	25	0.15	1.0
	T7325	0.4	140	0.10	0.8	110	0.09	0.8	-	-	-	-	-	-	45	0.07	0.6	-	-	-
CCGT 060208E-NF1	T6310	0.8	140	0.12	0.8	110	0.11	0.8	-	-	-	360	0.14	0.8	45	0.11	0.6	30	0.15	1.0
	T7325	0.8	140	0.12	0.8	110	0.11	0.8	-	-	-	-	-	-	45	0.11	0.6	-	-	-
CCGT 09T304E-NF1	T6310	0.4	140	0.10	1.2	110	0.09	1.2	-	-	-	360	0.12	1.2	38	0.07	1.0	25	0.15	1.0
	T7325	0.4	140	0.10	1.2	110	0.09	1.2	-	-	-	-	-	-	45	0.07	1.0	-	-	-
CCGT 09T308E-NF1	T6310	0.8	140	0.14	1.2	100	0.13	1.2	-	-	-	330	0.17	1.2	41	0.13	1.0	25	0.15	1.0
	T7325	0.8	140	0.14	1.2	100	0.13	1.2	-	-	-	-	-	-	45	0.13	1.0	-	-	-



Valores de inicio adecuados para la velocidad de corte (vc), avance (f) y profundidad de corte (ap). Consulte nuestra APP Calculadora de mecanizado para obtener más cálculos.

Producto	RE (mm)	P			M			K			N			S			H		
		vc (m/min)	f (mm/rev)	ap (mm)	vc (m/min)	f (mm/rev)	ap (mm)	vc (m/min)	f (mm/rev)	ap (mm)	vc (m/min)	f (mm/rev)	ap (mm)	vc (m/min)	f (mm/rev)	ap (mm)	vc (m/min)	f (mm/rev)	ap (mm)

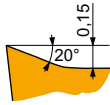

Geometría SF3 con diseño muy positivo para acabado fino con corte continuo.

CCGT 060202E-SF3	H07	0.2	–	–	–	110	0.05	0.8	115	0.05	0.8	360	0.06	0.8	45	0.04	0.6	–	–	–
	T6310	0.2	150	0.05	0.8	110	0.05	0.8	115	0.05	0.8	360	0.06	0.8	45	0.04	0.6	30	0.15	1.0
	T8315	0.2	150	0.05	0.8	110	0.05	0.8	115	0.05	0.8	360	0.06	0.8	38	0.04	0.6	30	0.15	1.0
CCGT 060204E-SF3	H07	0.4	–	–	–	95	0.09	0.8	115	0.10	0.8	360	0.12	0.8	34	0.07	0.6	–	–	–
	T6310	0.4	140	0.10	0.8	110	0.09	0.8	115	0.10	0.8	360	0.12	0.8	38	0.07	0.6	26	0.15	1.0
	T8315	0.4	140	0.10	0.8	110	0.09	0.8	115	0.10	0.8	360	0.12	0.8	34	0.07	0.6	26	0.15	1.0
CCGT 080302E-SF3	T6310	0.2	150	0.05	0.8	110	0.05	0.8	115	0.05	0.8	360	0.06	0.8	45	0.04	0.6	30	0.15	1.0
	T8315	0.2	150	0.05	0.8	110	0.05	0.8	115	0.05	0.8	360	0.06	0.8	38	0.04	0.6	30	0.15	1.0
	H07	0.4	–	–	–	95	0.09	1.0	115	0.10	1.0	360	0.12	1.0	34	0.07	0.8	–	–	–
CCGT 080304E-SF3	T6310	0.4	140	0.10	1.0	110	0.09	1.0	115	0.10	1.0	360	0.12	1.0	38	0.07	0.8	26	0.15	1.0
	T8315	0.4	140	0.10	1.0	110	0.09	1.0	115	0.10	1.0	360	0.12	1.0	34	0.07	0.8	26	0.15	1.0
	H07	0.4	–	–	–	95	0.09	1.0	115	0.10	1.0	360	0.12	1.0	34	0.07	0.8	–	–	–
CCGT 09T302E-SF3	H07	0.2	–	–	–	110	0.05	0.8	115	0.05	0.8	360	0.06	0.8	45	0.04	0.6	–	–	–
	T6310	0.2	150	0.05	0.8	110	0.05	0.8	115	0.05	0.8	360	0.06	0.8	45	0.04	0.6	30	0.15	1.0
	T8315	0.2	150	0.05	0.8	110	0.05	0.8	115	0.05	0.8	360	0.06	0.8	38	0.04	0.6	30	0.15	1.0
CCGT 09T304E-SF3	H07	0.4	–	–	–	95	0.09	1.0	115	0.10	1.0	360	0.12	1.0	34	0.07	0.8	–	–	–
	T6310	0.4	140	0.10	1.0	110	0.09	1.0	115	0.10	1.0	360	0.12	1.0	38	0.07	0.8	26	0.15	1.0
	T8315	0.4	140	0.10	1.0	110	0.09	1.0	115	0.10	1.0	360	0.12	1.0	34	0.07	0.8	26	0.15	1.0
CCGT 09T308E-SF3	H07	0.8	–	–	–	110	0.09	1.0	115	0.10	1.0	360	0.12	1.0	41	0.08	0.8	–	–	–
	T6310	0.8	140	0.10	1.0	110	0.09	1.0	115	0.10	1.0	360	0.12	1.0	45	0.08	0.8	30	0.15	1.0
	T8315	0.8	140	0.10	1.0	110	0.09	1.0	115	0.10	1.0	360	0.12	1.0	41	0.08	0.8	34	0.15	1.0
CCGT 120408E-SF3	H07	0.8	–	–	–	105	0.12	1.0	110	0.12	1.0	360	0.14	1.0	38	0.11	0.8	–	–	–
	T6310	0.8	140	0.12	1.0	110	0.12	1.0	110	0.12	1.0	360	0.14	1.0	45	0.11	0.8	30	0.15	1.0
	T8315	0.8	140	0.12	1.0	110	0.12	1.0	110	0.12	1.0	360	0.14	1.0	38	0.11	0.8	30	0.15	1.0

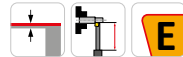

Geometría EL-SI con diseño positivo a izquierda para acabado fino con corte continuo.

CCGT 060202EL-SI	T8330	0.2	140	0.10	0.8	110	0.09	0.8	115	0.10	0.8	–	–	–	38	0.08	0.6	–	–	–
	T8430	0.2	140	0.10	0.8	110	0.09	0.8	115	0.10	0.8	–	–	–	38	0.08	0.6	–	–	–
CCGT 060204EL-SI	T8315	0.4	140	0.12	0.8	110	0.11	0.8	110	0.12	0.8	–	–	–	41	0.10	0.6	–	–	–
	T8330	0.4	140	0.12	0.8	110	0.11	0.8	110	0.12	0.8	–	–	–	38	0.10	0.6	–	–	–
CCGT 09T304EL-SI	T8315	0.4	140	0.12	0.8	110	0.11	0.8	110	0.12	0.8	–	–	–	38	0.10	0.6	–	–	–
	T8330	0.4	130	0.17	0.8	100	0.15	0.8	105	0.17	0.8	–	–	–	38	0.15	0.6	–	–	–
CCGT 120408EL-SI	T8330	0.8	130	0.23	1.0	95	0.21	1.0	95	0.23	1.0	–	–	–	38	0.21	0.8	–	–	–
	T8430	0.8	130	0.24	1.0	95	0.22	1.0	95	0.24	1.0	–	–	–	34	0.22	0.8	–	–	–



CCGW CBN

PRAMET

	IC (mm)	D1 (mm)	L (mm)	S (mm)
0602	6.350	2.80	6.50	2.38
09T3	9.525	4.50	9.70	3.97

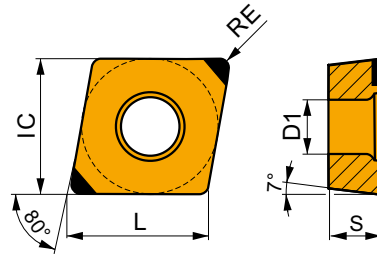

Valores de inicio adecuados para la velocidad de corte (vc), avance (f) y profundidad de corte (ap). Consulte nuestra APP Calculadora de mecanizado para obtener más cálculos.

Producto	RE (mm)	P			M			K			N			S			H		
		vc (m/min)	f (mm/rev)	ap (mm)	vc (m/min)	f (mm/rev)	ap (mm)	vc (m/min)	f (mm/rev)	ap (mm)	vc (m/min)	f (mm/rev)	ap (mm)	vc (m/min)	f (mm/rev)	ap (mm)	vc (m/min)	f (mm/rev)	ap (mm)



Para acabado.

CCGW 060204E-B	TB310	0.4	-	-	-	-	-	-	115	0.10	0.4	-	-	-	90	0.07	0.3	70	0.15	1.0
CCGW 09T304E-B	TB310	0.4	-	-	-	-	-	-	115	0.10	0.4	-	-	-	90	0.07	0.3	70	0.15	1.0

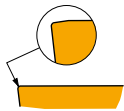

Para acabado.

CCGW 060204S01020B	TB310	0.4	-	-	-	-	-	-	115	0.10	0.4	-	-	-	90	0.07	0.3	70	0.15	1.0
CCGW 09T304S01020B	TB310	0.4	-	-	-	-	-	-	115	0.10	0.4	-	-	-	90	0.07	0.3	70	0.15	1.0

CCMT

PRAMET

	IC (mm)	D1 (mm)	L (mm)	S (mm)
0602	6.350	2.80	6.40	2.38
0803	7.940	3.40	8.10	3.18
09T3	9.525	4.40	9.70	3.97
1204	12.700	5.50	12.90	4.76

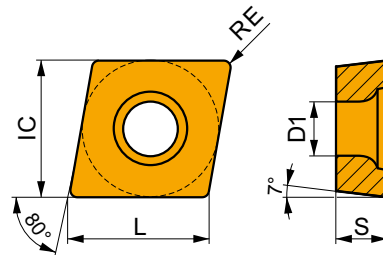

Valores de inicio adecuados para la velocidad de corte (vc), avance (f) y profundidad de corte (ap). Consulte nuestra APP Calculadora de mecanizado para obtener más cálculos.

Producto	RE (mm)	P			M			K			N			S			H		
		vc (m/min)	f (mm/rev)	ap (mm)	vc (m/min)	f (mm/rev)	ap (mm)	vc (m/min)	f (mm/rev)	ap (mm)	vc (m/min)	f (mm/rev)	ap (mm)	vc (m/min)	f (mm/rev)	ap (mm)	vc (m/min)	f (mm/rev)	ap (mm)

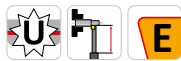
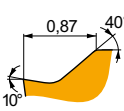

Geometría FF con un diseño muy positivo para operaciones de acabado y acabado fino con corte continuo y ligeramente interrumpido.

CCMT 060202E-FF	T8330	0.2	140	0.10	1.0	110	0.09	1.0	-	-	-	-	-	-	-	-	-	-	-	-
	T8430	0.2	140	0.10	1.0	110	0.09	1.0	-	-	-	-	-	-	-	-	-	-	-	-
CCMT 060204E-FF	T8330	0.4	140	0.12	1.0	110	0.11	1.0	-	-	-	-	-	-	-	-	-	-	-	-
	T8430	0.4	140	0.12	1.0	110	0.11	1.0	-	-	-	-	-	-	-	-	-	-	-	-
CCMT 09T304E-FF	T8330	0.4	140	0.12	1.2	110	0.11	1.2	-	-	-	-	-	-	-	-	-	-	-	-
	T8430	0.4	140	0.12	1.2	110	0.11	1.2	-	-	-	-	-	-	-	-	-	-	-	-



Valores de inicio adecuados para la velocidad de corte (vc), avance (f) y profundidad de corte (ap). Consulte nuestra APP Calculadora de mecanizado para obtener más cálculos.

Producto	RE (mm)	P			M			K			N			S			H		
		vc (m/min)	f (mm/rev)	ap (mm)	vc (m/min)	f (mm/rev)	ap (mm)	vc (m/min)	f (mm/rev)	ap (mm)	vc (m/min)	f (mm/rev)	ap (mm)	vc (m/min)	f (mm/rev)	ap (mm)	vc (m/min)	f (mm/rev)	ap (mm)

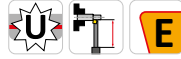
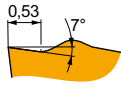

Geometría FF2 con un diseño muy positivo para operaciones de acabado y acabado fino con corte continuo y ligeramente interrumpido.

CCMT 060202E-FF2	T8330	0.2	150	0.05	0.8	-	-	-	115	0.05	0.8	-	-	-	-	-	-	-
	T8430	0.2	150	0.05	0.8	-	-	-	115	0.05	0.8	-	-	-	-	-	-	-
	T9325	0.2	150	0.05	0.8	-	-	-	115	0.05	0.8	-	-	-	-	-	-	-
	TT010	0.2	150	0.05	0.5	-	-	-	-	-	-	-	-	-	-	-	-	-
CCMT 060204E-FF2	T8330	0.4	140	0.12	1.0	-	-	-	110	0.12	1.0	-	-	-	-	-	-	-
	T8430	0.4	140	0.12	1.0	-	-	-	110	0.12	1.0	-	-	-	-	-	-	-
	T9325	0.4	140	0.12	1.0	-	-	-	110	0.12	1.0	-	-	-	-	-	-	-
	TT010	0.4	140	0.12	0.5	-	-	-	-	-	-	-	-	-	-	-	-	-
CCMT 080302E-FF2	T8330	0.2	150	0.05	0.8	-	-	-	115	0.05	0.8	-	-	-	-	-	-	-
	T8430	0.2	150	0.05	0.8	-	-	-	115	0.05	0.8	-	-	-	-	-	-	-
	T9325	0.2	150	0.05	0.8	-	-	-	115	0.05	0.8	-	-	-	-	-	-	-
	TT010	0.2	150	0.05	0.5	-	-	-	-	-	-	-	-	-	-	-	-	-
CCMT 080304E-FF2	T8330	0.4	140	0.12	1.0	-	-	-	110	0.12	1.0	-	-	-	-	-	-	-
	T8430	0.4	140	0.12	1.0	-	-	-	110	0.12	1.0	-	-	-	-	-	-	-
	T9325	0.4	140	0.12	1.0	-	-	-	110	0.12	1.0	-	-	-	-	-	-	-
	TT010	0.4	150	0.06	0.5	-	-	-	-	-	-	-	-	-	-	-	-	-
CCMT 080308E-FF2	T8330	0.8	130	0.17	1.0	-	-	-	105	0.17	1.0	-	-	-	-	-	-	-
	T8430	0.8	130	0.17	1.0	-	-	-	105	0.17	1.0	-	-	-	-	-	-	-
	T9325	0.8	130	0.17	1.0	-	-	-	105	0.17	1.0	-	-	-	-	-	-	-
CCMT 09T304E-FF2	T8330	0.4	140	0.12	1.2	-	-	-	110	0.12	1.2	-	-	-	-	-	-	-
	T8430	0.4	140	0.12	1.2	-	-	-	110	0.12	1.2	-	-	-	-	-	-	-
	T9325	0.4	140	0.12	1.2	-	-	-	110	0.12	1.2	-	-	-	-	-	-	-
	TT010	0.4	150	0.06	0.5	-	-	-	-	-	-	-	-	-	-	-	-	-
CCMT 09T308E-FF2	T8330	0.8	130	0.17	1.2	-	-	-	105	0.17	1.2	-	-	-	-	-	-	-
	T8430	0.8	130	0.17	1.2	-	-	-	105	0.17	1.2	-	-	-	-	-	-	-
	T9325	0.8	130	0.17	1.2	-	-	-	105	0.17	1.2	-	-	-	-	-	-	-
	TT010	0.8	140	0.10	0.8	-	-	-	-	-	-	-	-	-	-	-	-	-

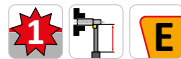

Geometría FM para acabado a semi-desbaste con corte continuo y ligeramente interrumpido.

CCMT 060202E-FM	T8330	0.2	140	0.10	1.0	110	0.09	1.0	115	0.10	1.0	360	0.12	1.0	-	-	-	-
	T8430	0.2	140	0.10	1.0	110	0.09	1.0	115	0.10	1.0	360	0.12	1.0	-	-	-	-
	T9325	0.2	140	0.10	1.0	110	0.09	1.0	115	0.10	1.0	-	-	-	-	-	-	-
CCMT 060204E-FM	T8330	0.4	140	0.15	1.0	100	0.14	1.0	110	0.15	1.0	330	0.18	1.0	-	-	-	-
	T8430	0.4	140	0.15	1.0	100	0.14	1.0	110	0.15	1.0	330	0.18	1.0	-	-	-	-
	T9325	0.4	140	0.15	1.0	100	0.15	1.0	110	0.15	1.0	-	-	-	-	-	-	-
CCMT 060208E-FM	T8330	0.8	130	0.20	1.0	100	0.18	1.0	100	0.20	1.0	300	0.24	1.0	-	-	-	-
	T8430	0.8	130	0.20	1.0	100	0.18	1.0	100	0.20	1.0	300	0.24	1.0	-	-	-	-
	T9325	0.8	130	0.20	1.0	100	0.18	1.0	100	0.20	1.0	-	-	-	-	-	-	-
CCMT 09T302E-FM	T8330	0.2	140	0.10	1.2	105	0.09	1.2	115	0.10	1.2	360	0.12	1.2	-	-	-	-
	T8430	0.2	140	0.10	1.2	110	0.09	1.2	115	0.10	1.2	360	0.12	1.2	-	-	-	-
	T9325	0.2	140	0.10	1.2	110	0.09	1.2	115	0.10	1.2	-	-	-	-	-	-	-
CCMT 09T304E-FM	T8330	0.4	140	0.15	1.2	100	0.14	1.2	110	0.15	1.2	330	0.18	1.2	-	-	-	-
	T8430	0.4	140	0.15	1.2	100	0.14	1.2	110	0.15	1.2	330	0.18	1.2	-	-	-	-
	T9325	0.4	140	0.15	1.2	100	0.15	1.2	110	0.15	1.2	-	-	-	-	-	-	-
CCMT 09T308E-FM	T8330	0.8	130	0.20	1.2	100	0.18	1.2	100	0.20	1.2	300	0.24	1.2	-	-	-	-
	T8430	0.8	130	0.20	1.2	100	0.18	1.2	100	0.20	1.2	300	0.24	1.2	-	-	-	-
	T9325	0.8	130	0.20	1.2	100	0.18	1.2	100	0.20	1.2	-	-	-	-	-	-	-
CCMT 120404E-FM	T8330	0.4	140	0.15	1.7	95	0.14	1.7	110	0.15	1.7	330	0.18	1.7	-	-	-	-
	T8430	0.4	140	0.15	1.7	100	0.14	1.7	110	0.15	1.7	330	0.18	1.7	-	-	-	-
	T9325	0.4	140	0.15	1.7	100	0.15	1.7	110	0.15	1.7	-	-	-	-	-	-	-
CCMT 120408E-FM	T8330	0.8	130	0.20	1.7	100	0.18	1.7	100	0.20	1.7	300	0.24	1.7	-	-	-	-
	T8430	0.8	130	0.20	1.7	100	0.18	1.7	100	0.20	1.7	300	0.24	1.7	-	-	-	-
	T9325	0.8	130	0.20	1.7	100	0.18	1.7	100	0.20	1.7	-	-	-	-	-	-	-



Valores de inicio adecuados para la velocidad de corte (vc), avance (f) y profundidad de corte (ap). Consulte nuestra APP Calculadora de mecanizado para obtener más cálculos.

Producto	RE (mm)	P			M			K			N			S			H		
		vc (m/min)	f (mm/rev)	ap (mm)	vc (m/min)	f (mm/rev)	ap (mm)	vc (m/min)	f (mm/rev)	ap (mm)	vc (m/min)	f (mm/rev)	ap (mm)	vc (m/min)	f (mm/rev)	ap (mm)	vc (m/min)	f (mm/rev)	ap (mm)

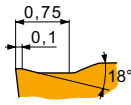

Geometría FM2 para acabado a mecanizado medio con corte continuo a interrumpido.

CCMT 080304E-FM2	T8330	0.4	140	0.12	1.0	95	0.11	1.0	110	0.12	1.0	-	-	-	-	-	-	-
	T8430	0.4	140	0.12	1.0	105	0.11	1.0	110	0.12	1.0	-	-	-	-	-	-	-
	T9325	0.4	140	0.12	1.0	110	0.11	1.0	110	0.12	1.0	-	-	-	-	-	-	-
CCMT 080308E-FM2	T8330	0.8	130	0.17	1.0	100	0.15	1.0	105	0.17	1.0	-	-	-	-	-	-	-
	T8430	0.8	130	0.17	1.0	100	0.15	1.0	105	0.17	1.0	-	-	-	-	-	-	-
	T9325	0.8	130	0.17	1.0	100	0.15	1.0	105	0.17	1.0	-	-	-	-	-	-	-
CCMT 09T304E-FM2	T8330	0.4	140	0.12	1.0	95	0.11	1.0	110	0.12	1.0	-	-	-	-	-	-	-
	T8430	0.4	140	0.12	1.0	105	0.11	1.0	110	0.12	1.0	-	-	-	-	-	-	-
	T9325	0.4	140	0.12	1.0	110	0.11	1.0	110	0.12	1.0	-	-	-	-	-	-	-
CCMT 09T308E-FM2	T8330	0.8	130	0.17	1.0	100	0.15	1.0	105	0.17	1.0	-	-	-	-	-	-	-
	T8430	0.8	130	0.17	1.0	100	0.15	1.0	105	0.17	1.0	-	-	-	-	-	-	-
	T9325	0.8	130	0.17	1.0	100	0.15	1.0	105	0.17	1.0	-	-	-	-	-	-	-
CCMT 120408E-FM2	T8330	0.8	130	0.20	1.5	95	0.18	1.5	100	0.20	1.5	-	-	-	-	-	-	-
	T8430	0.8	130	0.20	1.5	95	0.18	1.5	100	0.20	1.5	-	-	-	-	-	-	-
	T9325	0.8	130	0.20	1.5	100	0.18	1.5	100	0.20	1.5	-	-	-	-	-	-	-

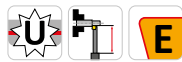

Geometría NF2 con diseño positivo para acabado fino a semi-desbaste con corte continuo.

CCMT 060202E-NF2	T6310	0.2	140	0.10	0.8	110	0.09	0.8	115	0.10	0.8	360	0.12	0.8	38	0.08	0.6	-	-	-
	T9325	0.2	140	0.10	0.8	110	0.09	0.8	115	0.10	0.8	-	-	-	41	0.08	0.6	-	-	-
CCMT 060204E-NF2	H07	0.4	-	-	-	85	0.11	0.8	110	0.12	0.8	360	0.14	0.8	34	0.11	0.6	-	-	-
	T6310	0.4	140	0.12	0.8	110	0.11	0.8	110	0.12	0.8	360	0.14	0.8	38	0.11	0.6	-	-	-
CCMT 080304E-NF2	T9325	0.4	140	0.12	0.8	110	0.11	0.8	110	0.12	0.8	-	-	-	41	0.11	0.6	-	-	-
	T9325	0.4	140	0.12	1.0	110	0.11	1.0	110	0.12	1.0	-	-	-	41	0.11	0.8	-	-	-
CCMT 080308E-NF2	T9325	0.8	130	0.17	1.0	100	0.15	1.0	105	0.17	1.0	-	-	-	41	0.14	0.8	-	-	-
CCMT 09T304E-NF2	H07	0.4	-	-	-	85	0.11	1.2	110	0.12	1.2	360	0.14	1.2	30	0.11	1.0	-	-	-
	T6310	0.4	140	0.12	1.2	110	0.11	1.2	110	0.12	1.2	360	0.14	1.2	34	0.11	1.0	-	-	-
	T9325	0.4	140	0.12	1.2	110	0.11	1.2	110	0.12	1.2	-	-	-	41	0.11	1.0	-	-	-
CCMT 09T308E-NF2	T6310	0.8	140	0.14	1.2	100	0.13	1.2	110	0.14	1.2	330	0.17	1.2	41	0.13	1.0	-	-	-
	T9325	0.8	140	0.14	1.2	100	0.13	1.2	110	0.14	1.2	-	-	-	45	0.13	1.0	-	-	-

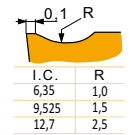

Geometría RF para semi-desbaste a desbaste, con corte continuo a interrumpido.

CCMT 060202E-RF	T7335	0.2	140	0.15	1.0	100	0.14	1.0	-	-	-	-	-	-	-	-	-	-	
CCMT 060204E-RF	T5315	0.4	140	0.15	1.0	-	-	-	110	0.15	1.0	-	-	-	35	0.15	1.0	-	-
	T7335	0.4	140	0.15	1.0	100	0.15	1.0	-	-	-	-	-	-	-	-	-	-	
CCMT 09T304E-RF	T7335	0.4	130	0.20	1.5	100	0.18	1.5	-	-	-	-	-	-	-	-	-	-	
CCMT 09T308E-RF	T5315	0.8	130	0.20	1.5	-	-	-	100	0.20	1.5	-	-	-	35	0.15	1.0	-	-
	T7335	0.8	130	0.20	1.5	100	0.18	1.5	-	-	-	-	-	-	-	-	-	-	
CCMT 120408E-RF	T5315	0.8	130	0.22	2.2	-	-	-	100	0.22	2.2	-	-	-	35	0.15	1.0	-	-
	T7335	0.8	130	0.22	2.2	95	0.22	2.2	-	-	-	-	-	-	-	-	-	-	

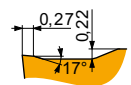
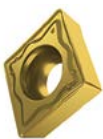

Geometría RM para semi-desbaste a desbaste, con corte continuo a interrumpido.

CCMT 09T304E-RM	T8330	0.4	120	0.27	2.2	80	0.24	2.2	95	0.27	2.2	-	-	-	26	0.19	1.8	20	0.15	1.0
	T8430	0.4	120	0.27	2.2	75	0.24	2.2	95	0.27	2.2	-	-	-	23	0.19	1.8	19	0.15	1.0
	T9325	0.4	120	0.27	2.2	95	0.24	2.2	95	0.27	2.2	-	-	-	30	0.19	1.8	-	-	-
CCMT 09T308E-RM	T8330	0.8	120	0.30	2.2	90	0.27	2.2	90	0.30	2.2	-	-	-	30	0.24	1.8	23	0.15	1.0
	T8430	0.8	120	0.30	2.2	90	0.27	2.2	90	0.30	2.2	-	-	-	26	0.24	1.8	23	0.15	1.0
	T9325	0.8	120	0.30	2.2	90	0.27	2.2	90	0.30	2.2	-	-	-	34	0.24	1.8	-	-	-



Valores de inicio adecuados para la velocidad de corte (vc), avance (f) y profundidad de corte (ap). Consulte nuestra APP Calculadora de mecanizado para obtener más cálculos.

Producto	RE (mm)	P			M			K			N			S			H		
		vc (m/min)	f (mm/rev)	ap (mm)	vc (m/min)	f (mm/rev)	ap (mm)	vc (m/min)	f (mm/rev)	ap (mm)	vc (m/min)	f (mm/rev)	ap (mm)	vc (m/min)	f (mm/rev)	ap (mm)	vc (m/min)	f (mm/rev)	ap (mm)

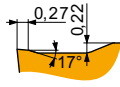
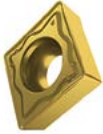

Geometría RM para semi-desbaste a desbaste, con corte continuo a interrumpido.

CCMT 120408E-RM	T8330	0.8	120	0.30	2.7	90	0.27	2.7	90	0.30	2.7	-	-	-	30	0.24	2.2	23	0.15	1.0
	T8430	0.8	120	0.30	2.7	90	0.27	2.7	90	0.30	2.7	-	-	-	26	0.24	2.2	23	0.15	1.0
	T9325	0.8	120	0.30	2.7	90	0.27	2.7	90	0.30	2.7	-	-	-	34	0.24	2.2	-	-	-

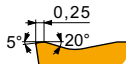

Geometría RM3 para semi-desbaste a desbaste, con corte continuo a interrumpido.

CCMT 120404E-RM3	T9325	0.4	120	0.25	2.5	95	0.25	2.5	95	0.25	2.5	-	-	-	-	-	-	-	-	-
CCMT 120408E-RM3	T6310	0.8	120	0.27	2.5	90	0.27	2.5	95	0.27	2.5	-	-	-	-	-	-	19	0.15	1.0
	T9325	0.8	120	0.27	2.5	90	0.27	2.5	95	0.27	2.5	-	-	-	-	-	-	-	-	-

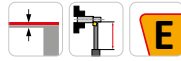
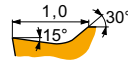

Geometría UR para acabado y acabado fino con corte continuo y ligeramente interrumpido.

CCMT 060202E-UR	T8330	0.2	140	0.10	0.8	95	0.09	0.8	115	0.10	0.8	-	-	-	-	-	-	-	-	-
	TT310	0.2	140	0.10	0.5	110	0.09	0.5	-	-	-	-	-	-	-	-	-	-	-	-
CCMT 060204E-UR	T8330	0.4	140	0.15	1.0	90	0.14	1.0	110	0.15	1.0	-	-	-	-	-	-	-	-	-
	TT310	0.4	140	0.15	0.5	100	0.14	0.5	-	-	-	-	-	-	-	-	-	-	-	-
CCMT 060208E-UR	T8330	0.8	130	0.20	1.0	95	0.18	1.0	100	0.20	1.0	-	-	-	-	-	-	-	-	-
CCMT 09T302E-UR	TT310	0.2	140	0.10	1.0	110	0.09	1.0	-	-	-	-	-	-	-	-	-	-	-	-
CCMT 09T304E-UR	T8330	0.4	140	0.15	1.2	90	0.14	1.2	110	0.15	1.2	-	-	-	-	-	-	-	-	-
	TT310	0.4	140	0.15	1.2	100	0.14	1.2	-	-	-	-	-	-	-	-	-	-	-	-
CCMT 09T308E-UR	T8330	0.8	130	0.20	1.2	95	0.18	1.2	100	0.20	1.2	-	-	-	-	-	-	-	-	-
	TT310	0.8	130	0.20	1.2	100	0.18	1.2	-	-	-	-	-	-	-	-	-	-	-	-
CCMT 120404E-UR	T8330	0.4	140	0.15	1.7	80	0.14	1.7	110	0.15	1.7	-	-	-	-	-	-	-	-	-
CCMT 120408E-UR	T8330	0.8	130	0.20	1.7	90	0.18	1.7	100	0.20	1.7	-	-	-	-	-	-	-	-	-

CCMW



	IC (mm)	D1 (mm)	L (mm)	S (mm)
0602	6.350	2.80	6.40	2.38
09T3	9.525	4.40	9.70	3.97
1204	12.700	5.50	12.90	4.76

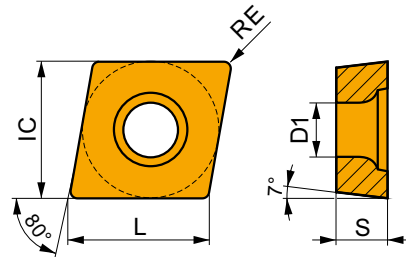

Valores de inicio adecuados para la velocidad de corte (vc), avance (f) y profundidad de corte (ap). Consulte nuestra APP Calculadora de mecanizado para obtener más cálculos.

Producto	RE (mm)	P			M			K			N			S			H		
		vc (m/min)	f (mm/rev)	ap (mm)	vc (m/min)	f (mm/rev)	ap (mm)	vc (m/min)	f (mm/rev)	ap (mm)	vc (m/min)	f (mm/rev)	ap (mm)	vc (m/min)	f (mm/rev)	ap (mm)	vc (m/min)	f (mm/rev)	ap (mm)

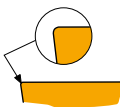

Para acabado fino a semi-desbaste con corte continuo y ligeramente interrumpido.

CCMW 060204	T5315	0.4	-	-	-	-	-	-	115	0.10	2.0	-	-	-	-	-	-	30	0.15	1.0
CCMW 09T304	T5315	0.4	-	-	-	-	-	-	115	0.10	3.0	-	-	-	-	-	-	30	0.15	1.0
CCMW 09T308	T5315	0.8	-	-	-	-	-	-	100	0.20	3.0	-	-	-	-	-	-	26	0.15	1.0



Valores de inicio adecuados para la velocidad de corte (vc), avance (f) y profundidad de corte (ap). Consulte nuestra APP Calculadora de mecanizado para obtener más cálculos.

Producto	RE (mm)	P			M			K			N			S			H		
		vc (m/min)	f (mm/rev)	ap (mm)	vc (m/min)	f (mm/rev)	ap (mm)	vc (m/min)	f (mm/rev)	ap (mm)	vc (m/min)	f (mm/rev)	ap (mm)	vc (m/min)	f (mm/rev)	ap (mm)	vc (m/min)	f (mm/rev)	ap (mm)

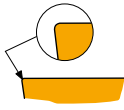
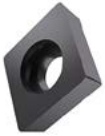

Para acabado fino a semi-desbaste con corte continuo y ligeramente interrumpido.

CCMW 120404	T5315	0.4	-	-	-	-	-	-	115	0.10	4.0	-	-	-	-	-	-	26	0.15	1.0
CCMW 120408	T5315	0.8	-	-	-	-	-	-	100	0.20	4.0	-	-	-	-	-	-	26	0.15	1.0

CNGA CBN

PRAMET

	IC (mm)	D1 (mm)	L (mm)	S (mm)
1204	12.700	5.16	12.90	4.76

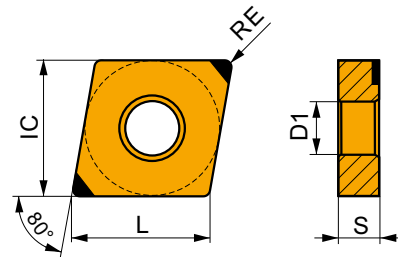

Valores de inicio adecuados para la velocidad de corte (vc), avance (f) y profundidad de corte (ap). Consulte nuestra APP Calculadora de mecanizado para obtener más cálculos.

Producto	RE (mm)	P			M			K			N			S			H		
		vc (m/min)	f (mm/rev)	ap (mm)	vc (m/min)	f (mm/rev)	ap (mm)	vc (m/min)	f (mm/rev)	ap (mm)	vc (m/min)	f (mm/rev)	ap (mm)	vc (m/min)	f (mm/rev)	ap (mm)	vc (m/min)	f (mm/rev)	ap (mm)

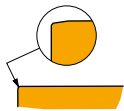

Para acabado con corte continuo.

CNGA 120404S01020B	TB310	0.4	-	-	-	-	-	-	115	0.10	0.4	-	-	-	100	0.07	0.3	80	0.15	1.0
CNGA 120408S01020B	TB310	0.8	-	-	-	-	-	-	110	0.15	0.6	-	-	-	100	0.11	0.5	85	0.15	1.0



CNGG

	IC	D1	L	S
	(mm)	(mm)	(mm)	(mm)
1204	12.700	5.16	12.90	4.76

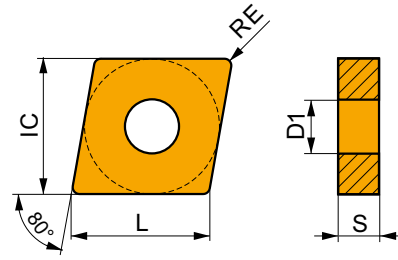

Valores de inicio adecuados para la velocidad de corte (vc), avance (f) y profundidad de corte (ap). Consulte nuestra APP Calculadora de mecanizado para obtener más cálculos.

Producto	RE	P			M			K			N			S			H		
		vc	f	ap	vc	f	ap	vc	f	ap	vc	f	ap	vc	f	ap	vc	f	ap
	(mm)	(m/min)	(mm/rev)	(mm)	(m/min)	(mm/rev)	(mm)	(m/min)	(mm/rev)	(mm)	(m/min)	(mm/rev)	(mm)	(m/min)	(mm/rev)	(mm)	(m/min)	(mm/rev)	(mm)

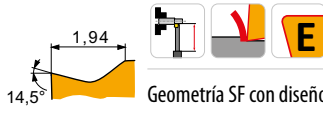

Geometría SF con diseño positivo para acabado fino de paredes delgadas con corte continuo.

CNGG 120402E-SF	H07	0.2	–	–	–	105	0.09	1.0	115	0.10	1.0	360	0.12	1.0	38	0.08	0.8	–	–	–
	T6310	0.2	140	0.10	1.0	110	0.09	1.0	115	0.10	1.0	360	0.12	1.0	41	0.08	0.8	26	0.15	1.0
	T8330	0.2	140	0.10	1.0	110	0.09	1.0	115	0.10	1.0	360	0.12	1.0	34	0.08	0.8	26	0.15	1.0
	T8430	0.2	140	0.10	1.0	110	0.09	1.0	115	0.10	1.0	360	0.12	1.0	34	0.08	0.8	30	0.15	1.0

CNMA

	IC	D1	L	S
	(mm)	(mm)	(mm)	(mm)
1204	12.700	5.16	12.90	4.76

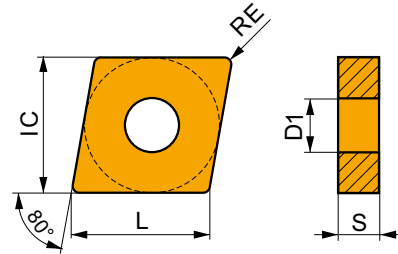

Valores de inicio adecuados para la velocidad de corte (vc), avance (f) y profundidad de corte (ap). Consulte nuestra APP Calculadora de mecanizado para obtener más cálculos.

Producto	RE	P			M			K			N			S			H		
		vc	f	ap	vc	f	ap	vc	f	ap	vc	f	ap	vc	f	ap	vc	f	ap
	(mm)	(m/min)	(mm/rev)	(mm)	(m/min)	(mm/rev)	(mm)	(m/min)	(mm/rev)	(mm)	(m/min)	(mm/rev)	(mm)	(m/min)	(mm/rev)	(mm)	(m/min)	(mm/rev)	(mm)

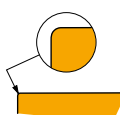

Para acabado fino a semi-desbaste con corte continuo y ligeramente interrumpido.

CNMA 120404	T5315	0.4	–	–	–	–	–	–	115	0.10	4.0	–	–	–	–	–	–	30	0.15	1.0
CNMA 120408	T5315	0.8	–	–	–	–	–	–	100	0.20	4.0	–	–	–	–	–	–	30	0.15	1.0
CNMA 120412	T5315	1.2	–	–	–	–	–	–	90	0.30	4.0	–	–	–	–	–	–	25	0.15	1.0



CNMG



	IC	D1	L	S
	(mm)	(mm)	(mm)	(mm)
1204	12.700	5.16	12.90	4.76

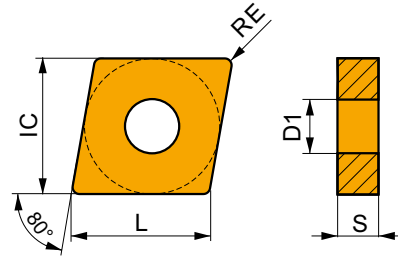

Valores de inicio adecuados para la velocidad de corte (vc), avance (f) y profundidad de corte (ap). Consulte nuestra APP Calculadora de mecanizado para obtener más cálculos.

Producto	RE	P			M			K			N			S			H		
		vc	f	ap	vc	f	ap	vc	f	ap	vc	f	ap	vc	f	ap	vc	f	ap
	(mm)	(m/min)	(mm/rev)	(mm)	(m/min)	(mm/rev)	(mm)	(m/min)	(mm/rev)	(mm)	(m/min)	(mm/rev)	(mm)	(m/min)	(mm/rev)	(mm)	(m/min)	(mm/rev)	(mm)

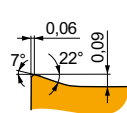
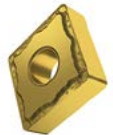

Geometría FF con un diseño muy positivo para operaciones de acabado fino con corte continuo y ligeramente interrumpido.

CNMG 120404E-FF	T7325	0.4	✓	140	0.12	1.0	■	110	0.11	1.0	—	—	—	—	—	—	—	—	—
	T8315	0.4	✓	140	0.12	1.0	■	110	0.11	1.0	✓	110	0.12	1.0	—	—	—	—	—
CNMG 120408E-FF	T7325	0.8	✓	140	0.15	1.0	■	100	0.14	1.0	—	—	—	—	—	—	—	—	—
	T8315	0.8	✓	140	0.15	1.0	■	100	0.14	1.0	✓	110	0.15	1.0	—	—	—	—	—

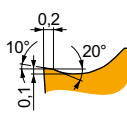

Geometría FM con diseño positivo para acabado a semi-desbaste con corte continuo y ligeramente interrumpido.

CNMG 120404E-FM	T9325	0.4	■	130	0.20	2.1	✓	100	0.18	2.1	✓	100	0.20	2.1	—	—	—	✓	38	0.16	1.7	—	—	—
	TT310	0.4	■	130	0.20	2.1	✓	100	0.18	2.1	—	—	—	—	—	—	—	—	—	—	—	—	—	
CNMG 120408E-FM	T9325	0.8	■	130	0.20	2.1	✓	100	0.18	2.1	✓	100	0.20	2.1	—	—	—	✓	45	0.16	1.7	—	—	—
	TT310	0.8	■	130	0.20	2.1	✓	100	0.18	2.1	—	—	—	—	—	—	—	—	—	—	—	—	—	

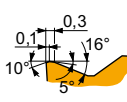

Geometría M para acabado a semi-desbaste con corte continuo a interrumpido.

CNMG 120404E-M	T5315	0.4	✓	130	0.20	2.1	—	—	—	■	100	0.20	2.1	—	—	—	—	—	—	—	—	—	—	—
	T9325	0.4	■	130	0.20	2.1	—	—	—	✓	100	0.20	2.1	—	—	—	—	—	—	—	—	—	—	—
CNMG 120408E-M	T5315	0.8	✓	120	0.32	2.1	—	—	—	■	90	0.32	2.1	—	—	—	—	—	—	—	—	—	—	—
	T9325	0.8	■	120	0.32	2.1	—	—	—	✓	90	0.32	2.1	—	—	—	—	—	—	—	—	—	—	—

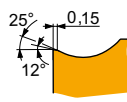

Geometría NF con diseño muy positivo, para acabado fino a mecanizado medio con corte continuo.

CNMG 120404E-NF	T7325	0.4	✓	130	0.18	1.7	■	100	0.16	1.7	—	—	—	—	—	—	—	—	—	—	—	—	—	—	
	T8330	0.4	■	130	0.17	1.7	■	100	0.15	1.7	✓	105	0.17	1.7	✓	330	0.20	1.7	✓	34	0.14	1.4	—	—	—
	T8430	0.4	■	130	0.17	1.7	■	100	0.15	1.7	✓	105	0.17	1.7	✓	330	0.20	1.7	✓	30	0.14	1.4	—	—	—
CNMG 120408E-NF	T7325	0.8	✓	130	0.19	1.7	■	100	0.17	1.7	—	—	—	—	—	—	—	—	—	—	—	—	—	—	
	T8330	0.8	■	130	0.19	1.7	■	100	0.17	1.7	✓	100	0.19	1.7	✓	300	0.23	1.7	✓	38	0.15	1.4	—	—	—
	T8430	0.8	■	130	0.19	1.7	■	100	0.17	1.7	✓	100	0.19	1.7	✓	300	0.23	1.7	✓	34	0.15	1.4	—	—	—

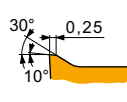









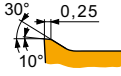

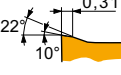
Geometría NM con diseño muy positivo para acabado fino, mecanizado medio y desbaste con corte continuo.

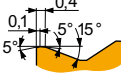
CNMG 120404E-NM	T7325	0.4	✓	130	0.20	2.1	■	100	0.18	2.1	—	—	—	—	—	—	—	—	—	—	—	—	—	—
	T8330	0.4	■	130	0.20	2.1	■	100	0.18	2.1	—	—	—	✓	300	0.24	2.1	✓	30	0.16	1.7	—	—	—
	T8430	0.4	■	130	0.20	2.1	■	100	0.18	2.1	—	—	—	✓	300	0.24	2.1	✓	30	0.16	1.7	—	—	—

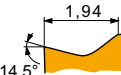

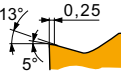
Valores de inicio adecuados para la velocidad de corte (vc), avance (f) y profundidad de corte (ap). Consulte nuestra APP Calculadora de mecanizado para obtener más cálculos.

Producto	RE (mm)	P			M			K			N			S			H		
		vc (m/min)	f (mm/rev)	ap (mm)	vc (m/min)	f (mm/rev)	ap (mm)	vc (m/min)	f (mm/rev)	ap (mm)	vc (m/min)	f (mm/rev)	ap (mm)	vc (m/min)	f (mm/rev)	ap (mm)	vc (m/min)	f (mm/rev)	ap (mm)
																			
CNMG 120408E-NM	T7325	0.8	120	0.25	2.1	95	0.23	2.1	-	-	-	-	-	-	45	0.20	1.7	-	-
	T8330	0.8	120	0.25	2.1	95	0.23	2.1	-	-	-	270	0.30	2.1	34	0.20	1.7	-	-
	T8430	0.8	120	0.25	2.1	95	0.23	2.1	-	-	-	270	0.30	2.1	30	0.20	1.7	-	-
																			
CNMG 120404E-NMR	T7325	0.4	120	0.25	2.7	95	0.23	2.7	-	-	-	-	-	-	38	0.20	2.2	-	-
	T8330	0.4	120	0.25	2.0	80	0.23	2.0	-	-	-	-	-	-	26	0.20	1.6	-	-
	T8430	0.4	120	0.25	2.7	75	0.23	2.7	-	-	-	-	-	-	23	0.20	2.2	-	-
CNMG 120408E-NMR	T7325	0.8	120	0.35	2.7	90	0.32	2.7	-	-	-	-	-	-	41	0.25	2.2	-	-
	T8330	0.8	120	0.35	2.7	90	0.32	2.7	-	-	-	-	-	-	26	0.25	2.2	-	-
	T8430	0.8	120	0.35	2.7	80	0.32	2.7	-	-	-	-	-	-	23	0.25	2.2	-	-
																			
CNMG 120408E-R	T5315	0.8	120	0.40	4.0	-	-	-	80	0.40	4.0	-	-	-	-	-	-	30	0.15
	T9325	0.8	120	0.40	4.0	-	-	-	80	0.40	4.0	-	-	-	-	-	-	-	-
																			
CNMG 120404E-SF	H07	0.4	-	-	-	90	0.14	1.0	110	0.15	1.0	330	0.18	1.0	34	0.12	0.8	-	-
	T6310	0.4	140	0.15	1.0	100	0.14	1.0	110	0.15	1.0	330	0.18	1.0	38	0.12	0.8	26	0.15
CNMG 120408E-SF	H07	0.8	-	-	-	95	0.18	1.0	100	0.20	1.0	300	0.24	1.0	38	0.14	0.8	-	-
	T6310	0.8	130	0.20	1.0	100	0.18	1.0	100	0.20	1.0	300	0.24	1.0	45	0.14	0.8	30	0.15
																			
CNMG 120404E-SM	T6310	0.4	130	0.22	2.0	95	0.20	2.0	100	0.22	2.0	300	0.26	2.0	34	0.20	1.6	23	0.15
	T7325	0.4	130	0.22	2.0	95	0.20	2.0	-	-	-	-	-	-	41	0.20	1.6	-	-
CNMG 120408E-SM	T6310	0.8	120	0.25	2.0	95	0.23	2.0	95	0.25	2.0	270	0.30	2.0	38	0.20	1.6	26	0.15
	T7325	0.8	120	0.25	2.0	95	0.23	2.0	-	-	-	-	-	-	45	0.20	1.6	-	-
																			
CNMG 120404EL-SI	T7325	0.4	130	0.20	1.7	100	0.18	1.7	-	-	-	-	-	-	45	0.18	1.4	-	-
	T8330	0.4	130	0.20	1.7	100	0.18	1.7	-	-	-	300	0.24	1.7	34	0.18	1.4	-	-
	T8430	0.4	130	0.20	1.7	100	0.18	1.7	-	-	-	300	0.24	1.7	34	0.18	1.4	-	-
CNMG 120408EL-SI	T7325	0.8	120	0.35	1.7	90	0.32	1.7	-	-	-	-	-	-	45	0.25	1.4	-	-
	T8330	0.8	120	0.35	1.7	90	0.32	1.7	-	-	-	220	0.42	1.7	34	0.25	1.4	-	-
	T8430	0.8	120	0.35	1.7	90	0.32	1.7	-	-	-	220	0.42	1.7	30	0.25	1.4	-	-



DCMT



	IC (mm)	D1 (mm)	L (mm)	S (mm)
11T3	9.525	4.40	11.60	3.97
1504	12.700	5.50	15.50	4.76

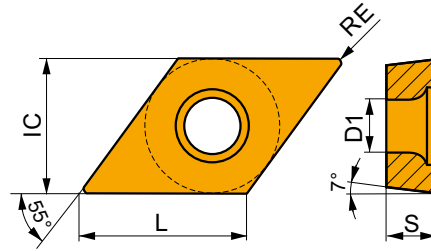

Valores de inicio adecuados para la velocidad de corte (vc), avance (f) y profundidad de corte (ap). Consulte nuestra APP Calculadora de mecanizado para obtener más cálculos.

Producto	RE (mm)	P			M			K			N			S			H		
		vc (m/min)	f (mm/rev)	ap (mm)	vc (m/min)	f (mm/rev)	ap (mm)	vc (m/min)	f (mm/rev)	ap (mm)	vc (m/min)	f (mm/rev)	ap (mm)	vc (m/min)	f (mm/rev)	ap (mm)	vc (m/min)	f (mm/rev)	ap (mm)

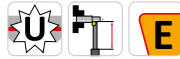
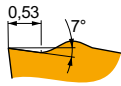

Geometría FF2 con un diseño muy positivo para operaciones de acabado y acabado fino con corte continuo y ligeramente interrumpido.

DCMT 11T308E-FF2	T7325	0.8	130	0.17	0.8	-	-	-	-	-	-	-	-	-	-	-	-	-
	T8330	0.8	130	0.17	0.8	-	-	-	105	0.17	0.8	-	-	-	-	-	-	-
	T8430	0.8	130	0.17	0.8	-	-	-	105	0.17	0.8	-	-	-	-	-	-	-

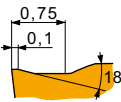

Geometría FM2 para acabado a mecanizado medio con corte continuo a interrumpido.

DCMT 150408E-FM2	T9325	0.8	130	0.20	1.5	100	0.18	1.5	100	0.20	1.5	-	-	-	-	-	-	-
	T9335	0.8	130	0.20	1.5	95	0.18	1.5	-	-	-	-	-	-	-	-	-	-

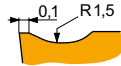

Geometría RF para semi-desbaste a desbaste, con corte continuo a interrumpido.

DCMT 11T308E-RF	T5315	0.8	130	0.20	0.8	-	-	-	100	0.20	0.8	-	-	-	-	-	30	0.15	1.0
	T7335	0.8	130	0.20	0.8	100	0.18	0.8	-	-	-	-	-	-	-	-	-	-	-



DCMW

	IC (mm)	D1 (mm)	L (mm)	S (mm)
11T3	9.525	4.40	11.60	3.97

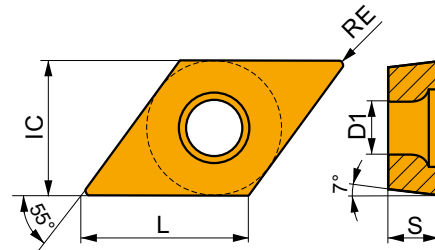

Valores de inicio adecuados para la velocidad de corte (vc), avance (f) y profundidad de corte (ap). Consulte nuestra APP Calculadora de mecanizado para obtener más cálculos.

Producto	RE (mm)	P			M			K			N			S			H		
		vc (m/min)	f (mm/rev)	ap (mm)	vc (m/min)	f (mm/rev)	ap (mm)	vc (m/min)	f (mm/rev)	ap (mm)	vc (m/min)	f (mm/rev)	ap (mm)	vc (m/min)	f (mm/rev)	ap (mm)	vc (m/min)	f (mm/rev)	ap (mm)



Para acabado fino a semi-desbaste con corte continuo y ligeramente interrumpido.

DCMW 11T304	T5315	0.4	–	–	–	–	–	–	–	115	0.10	1.2	–	–	–	–	–	–	–	26	0.15	1.0
	T6310	0.4	–	–	–	–	–	–	–	80	0.10	1.2	–	–	–	–	–	–	–	15	0.15	1.0
DCMW 11T308	T5315	0.8	–	–	–	–	–	–	–	105	0.18	1.2	–	–	–	–	–	–	–	23	0.15	1.0
	T6310	0.8	–	–	–	–	–	–	–	80	0.18	1.2	–	–	–	–	–	–	–	15	0.15	1.0

DCMW PCD

	IC (mm)	D1 (mm)	L (mm)	S (mm)
11T3	9.525	4.40	11.60	3.97

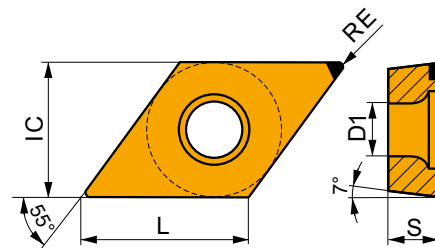

Valores de inicio adecuados para la velocidad de corte (vc), avance (f) y profundidad de corte (ap). Consulte nuestra APP Calculadora de mecanizado para obtener más cálculos.

Producto	RE (mm)	P			M			K			N			S			H		
		vc (m/min)	f (mm/rev)	ap (mm)	vc (m/min)	f (mm/rev)	ap (mm)	vc (m/min)	f (mm/rev)	ap (mm)	vc (m/min)	f (mm/rev)	ap (mm)	vc (m/min)	f (mm/rev)	ap (mm)	vc (m/min)	f (mm/rev)	ap (mm)

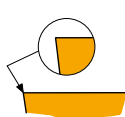

Para acabado con altas velocidades y condiciones estables.

DCMW 11T304FN	PD1	0.4	–	–	–	–	–	–	–	360	0.12	0.5	–	–	–	–	–	–	–	–	–	–
DCMW 11T308FN	PD1	0.8	–	–	–	–	–	–	–	360	0.12	1.0	–	–	–	–	–	–	–	–	–	–



EPGX

	IC	D1	L	S
	(mm)	(mm)	(mm)	(mm)
0502	5.560	2.50	5.70	2.38

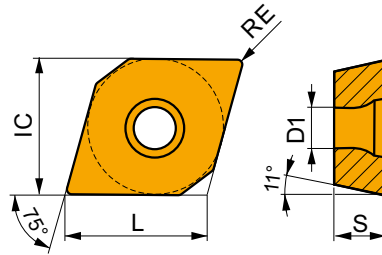

Valores de inicio adecuados para la velocidad de corte (vc), avance (f) y profundidad de corte (ap). Consulte nuestra APP Calculadora de mecanizado para obtener más cálculos.

Producto	RE	P			M			K			N			S			H		
		vc	f	ap	vc	f	ap	vc	f	ap	vc	f	ap	vc	f	ap	vc	f	ap
	(mm)	(m/min)	(mm/rev)	(mm)	(m/min)	(mm/rev)	(mm)	(m/min)	(mm/rev)	(mm)	(m/min)	(mm/rev)	(mm)	(m/min)	(mm/rev)	(mm)	(m/min)	(mm/rev)	(mm)

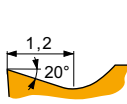

Geometría FL-JZ con diseño positivo a izquierda para operaciones de acabado fino con corte continuo.

EPGX 050202FL-JZ	TT010	0.2	150	0.06	0.5	110	0.05	0.5	-	-	-	-	-	-	-	-	-	-	-
------------------	-------	-----	-----	------	-----	-----	------	-----	---	---	---	---	---	---	---	---	---	---	---

EPMT

	IC	D1	L	S
	(mm)	(mm)	(mm)	(mm)
0502	5.560	2.50	5.70	2.38

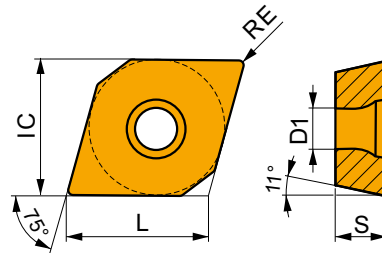

Valores de inicio adecuados para la velocidad de corte (vc), avance (f) y profundidad de corte (ap). Consulte nuestra APP Calculadora de mecanizado para obtener más cálculos.

Producto	RE	P			M			K			N			S			H		
		vc	f	ap	vc	f	ap	vc	f	ap	vc	f	ap	vc	f	ap	vc	f	ap
	(mm)	(m/min)	(mm/rev)	(mm)	(m/min)	(mm/rev)	(mm)	(m/min)	(mm/rev)	(mm)	(m/min)	(mm/rev)	(mm)	(m/min)	(mm/rev)	(mm)	(m/min)	(mm/rev)	(mm)



Geometría NF2 con diseño positivo para acabado fino a semi-desbaste con corte continuo.

EPMT 050202E-NF2	H07	0.2	-	-	-	80	0.09	0.8	115	0.10	0.8	360	0.12	0.8	30	0.07	0.6	-	-	-
	T7325	0.2	150	0.07	0.8	110	0.06	0.8	-	-	-	-	-	-	45	0.06	0.6	-	-	-
	T7335	0.2	150	0.07	0.8	110	0.06	0.8	-	-	-	-	-	-	45	0.06	0.6	-	-	-
	T9315	0.2	150	0.05	0.8	-	-	-	115	0.05	0.8	-	-	-	-	-	-	-	-	-
	T9325	0.2	150	0.07	0.8	110	0.06	0.8	115	0.07	0.8	-	-	-	45	0.06	0.6	-	-	-
	T9335	0.2	140	0.10	0.8	110	0.09	0.8	-	-	-	-	-	-	34	0.07	0.6	-	-	-
	TT010	0.2	150	0.05	0.5	110	0.05	0.5	-	-	-	-	-	-	-	-	-	-	-	-



TCGT



	IC (mm)	D1 (mm)	L (mm)	S (mm)
06T1	3.970	2.20	6.90	1.98
0902	5.560	2.50	9.60	2.38
1102-SF3	6.350	2.80	11.00	2.58
16T3	9.525	4.40	16.50	3.97
16T3-SF3	9.525	4.40	16.50	4.22

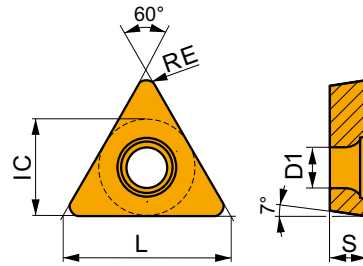

Valores de inicio adecuados para la velocidad de corte (vc), avance (f) y profundidad de corte (ap). Consulte nuestra APP Calculadora de mecanizado para obtener más cálculos.

Producto	RE (mm)	P			M			K			N			S			H		
		vc (m/min)	f (mm/rev)	ap (mm)	vc (m/min)	f (mm/rev)	ap (mm)	vc (m/min)	f (mm/rev)	ap (mm)	vc (m/min)	f (mm/rev)	ap (mm)	vc (m/min)	f (mm/rev)	ap (mm)	vc (m/min)	f (mm/rev)	ap (mm)



Geometría AL con un diseño muy positivo para operaciones de acabado fino a desbaste, con corte continuo y ligeramente interrumpido.

TCGT 090202F-AL	HF7	0.2	-	-	-	-	-	-	-	-	-	360	0.12	1.0	-	-	-	-	-	-
	T0315	0.2	-	-	-	-	-	-	-	-	-	360	0.12	1.0	-	-	-	-	-	-
TCGT 090204F-AL	HF7	0.4	-	-	-	-	-	-	-	-	-	300	0.24	1.0	-	-	-	-	-	-
	T0315	0.4	-	-	-	-	-	-	-	-	-	300	0.24	1.0	-	-	-	-	-	-
TCGT 16T304F-AL	HF7	0.4	-	-	-	-	-	-	-	-	-	300	0.24	2.4	-	-	-	-	-	-
	T0315	0.4	-	-	-	-	-	-	-	-	-	300	0.24	2.4	-	-	-	-	-	-
TCGT 16T308F-AL	HF7	0.8	-	-	-	-	-	-	-	-	-	200	0.48	2.4	-	-	-	-	-	-
	T0315	0.8	-	-	-	-	-	-	-	-	-	200	0.48	2.4	-	-	-	-	-	-

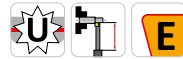
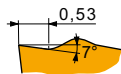

Geometría FF2 con un diseño muy positivo para operaciones de acabado y acabado fino con corte continuo y ligeramente interrumpido.

TCGT 06T102E-FF2	T8330	0.2	150	0.05	0.8	-	-	-	115	0.05	0.8	-	-	-	-	-	-	-	-	-
	T8430	0.2	150	0.05	0.8	-	-	-	115	0.05	0.8	-	-	-	-	-	-	-	-	-
TCGT 090202E-FF2	TT010	0.2	150	0.05	0.5	-	-	-	-	-	-	-	-	-	-	-	-	-	-	-
	TT010	0.2	150	0.05	0.5	-	-	-	-	-	-	-	-	-	-	-	-	-	-	-

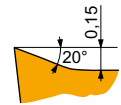

Geometría SF3 con diseño muy positivo para acabado fino con corte continuo.

TCGT 110204E-SF3	H07	0.4	-	-	-	80	0.09	0.8	115	0.10	0.8	360	0.12	0.8	30	0.07	0.6	-	-	-
	T6310	0.4	140	0.10	0.8	110	0.09	0.8	115	0.10	0.8	360	0.12	0.8	34	0.07	0.6	23	0.15	1.0
TCGT 16T308E-SF3	H07	0.8	-	-	-	90	0.09	1.2	115	0.10	1.2	360	0.12	1.2	34	0.08	1.0	-	-	-
	T6310	0.8	140	0.10	1.2	110	0.09	1.2	115	0.10	1.2	360	0.12	1.2	38	0.08	1.0	26	0.15	1.0



TCMT



	IC	D1	L	S
	(mm)	(mm)	(mm)	(mm)
06T1	3.970	2.20	6.90	1.98
0902	5.560	2.50	9.60	2.38
16T3	9.525	4.40	16.50	3.97

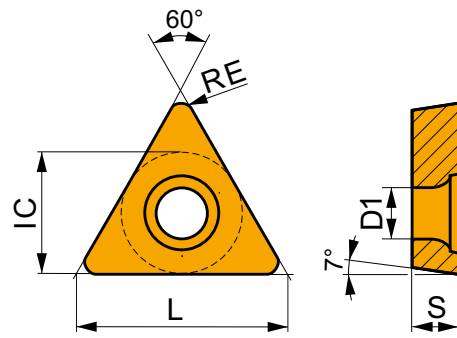

Valores de inicio adecuados para la velocidad de corte (vc), avance (f) y profundidad de corte (ap). Consulte nuestra APP Calculadora de mecanizado para obtener más cálculos.

Producto	RE	P			M			K			N			S			H		
		vc	f	ap	vc	f	ap	vc	f	ap	vc	f	ap	vc	f	ap	vc	f	ap
	(mm)	(m/min)	(mm/rev)	(mm)	(m/min)	(mm/rev)	(mm)	(m/min)	(mm/rev)	(mm)	(m/min)	(mm/rev)	(mm)	(m/min)	(mm/rev)	(mm)	(m/min)	(mm/rev)	(mm)

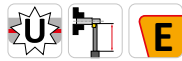
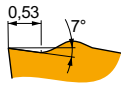

Geometría FF2 con un diseño muy positivo para operaciones de acabado y acabado fino con corte continuo y ligeramente interrumpido.

TCMT 06T102E-FF2	T8330	0.2	█	150	0.05	0.8	█	–	–	–	█	115	0.05	0.8	–	–	–	–	–	–	–
	T8430	0.2	█	150	0.05	0.8	█	–	–	–	█	115	0.05	0.8	–	–	–	–	–	–	–
	T9315	0.2	█	150	0.05	0.8	█	–	–	–	█	115	0.05	0.8	–	–	–	–	–	–	–
TCMT 06T104E-FF2	T8330	0.4	█	140	0.12	0.8	█	–	–	–	█	110	0.12	0.8	–	–	–	–	–	–	–
	T8430	0.4	█	140	0.12	0.8	█	–	–	–	█	110	0.12	0.8	–	–	–	–	–	–	–
	T9325	0.4	█	140	0.12	0.8	█	–	–	–	█	110	0.12	0.8	–	–	–	–	–	–	–
TCMT 090204E-FF2	T8330	0.4	█	140	0.12	1.0	█	–	–	–	█	110	0.12	1.0	–	–	–	–	–	–	–
	T8430	0.4	█	140	0.12	1.0	█	–	–	–	█	110	0.12	1.0	–	–	–	–	–	–	–
	T9325	0.4	█	140	0.12	1.0	█	–	–	–	█	110	0.12	1.0	–	–	–	–	–	–	–
TCMT 16T304E-FF2	T8330	0.4	█	140	0.12	0.8	█	–	–	–	█	110	0.12	0.8	–	–	–	–	–	–	–
	T8430	0.4	█	140	0.12	0.8	█	–	–	–	█	110	0.12	0.8	–	–	–	–	–	–	–
	T9325	0.4	█	140	0.12	0.8	█	–	–	–	█	110	0.12	0.8	–	–	–	–	–	–	–
TCMT 16T308E-FF2	TT010	0.4	█	150	0.06	0.5	█	–	–	–	–	–	–	–	–	–	–	–	–	–	–
	T8330	0.8	█	130	0.17	0.8	█	–	–	–	█	105	0.17	0.8	–	–	–	–	–	–	–
	T8430	0.8	█	130	0.17	0.8	█	–	–	–	█	105	0.17	0.8	–	–	–	–	–	–	–
T9325	0.8	█	130	0.17	0.8	█	–	–	–	█	105	0.17	0.8	–	–	–	–	–	–	–	–

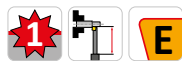

Geometría FM para acabado a semi-desbaste con corte continuo y ligeramente interrumpido.

TCMT 16T304E-FM	T7325	0.4	█	130	0.19	1.7	█	100	0.17	1.7	█	–	–	–	–	–	–	–	–	–	–
	T8330	0.4	█	140	0.12	1.7	█	90	0.11	1.7	█	110	0.12	1.7	█	360	0.14	1.7	–	–	–
	T8430	0.4	█	140	0.12	1.7	█	90	0.11	1.7	█	110	0.12	1.7	█	360	0.14	1.7	–	–	–

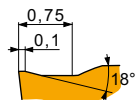

Geometría FM2 para acabado a mecanizado medio con corte continuo a interrumpido.

TCMT 16T308E-FM2	T8330	0.8	█	130	0.20	1.0	█	85	0.18	1.0	█	100	0.20	1.0	–	–	–	–	–	–	–
	T8430	0.8	█	130	0.20	1.0	█	85	0.18	1.0	█	100	0.20	1.0	–	–	–	–	–	–	–
	T9325	0.8	█	130	0.20	1.0	█	100	0.18	1.0	█	100	0.20	1.0	–	–	–	–	–	–	–

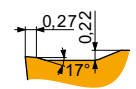

Geometría RM para semi-desbaste a desbaste, con corte continuo a interrumpido.

TCMT 16T308E-RM	T5315	0.8	█	120	0.27	1.9	█	–	–	–	█	95	0.27	1.9	–	–	–	–	–	–	–
	T8330	0.8	█	120	0.27	1.9	█	85	0.24	1.9	█	95	0.27	1.9	–	–	–	█	26	0.19	1.5
	T8430	0.8	█	120	0.27	1.9	█	85	0.24	1.9	█	95	0.27	1.9	–	–	–	█	23	0.19	1.5



Valores de inicio adecuados para la velocidad de corte (vc), avance (f) y profundidad de corte (ap). Consulte nuestra APP Calculadora de mecanizado para obtener más cálculos.

Producto	RE (mm)	P			M			K			N			S			H		
		vc (m/min)	f (mm/rev)	ap (mm)	vc (m/min)	f (mm/rev)	ap (mm)	vc (m/min)	f (mm/rev)	ap (mm)	vc (m/min)	f (mm/rev)	ap (mm)	vc (m/min)	f (mm/rev)	ap (mm)	vc (m/min)	f (mm/rev)	ap (mm)

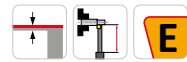
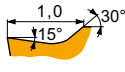

Geometría UR para acabado y acabado fino con corte continuo y ligeramente interrumpido.

TCMT 16T304E-UR	T8330	0.4	135	0.12	0.8	80	0.11	0.8	110	0.12	0.8	-	-	-	-	-	-	-
	T8430	0.4	140	0.12	0.8	85	0.11	0.8	110	0.12	0.8	-	-	-	-	-	-	-
	T9325	0.4	130	0.18	0.8	100	0.16	0.8	105	0.18	0.8	-	-	-	-	-	-	-
TCMT 16T308E-UR	TT310	0.4	140	0.12	0.8	110	0.11	0.8	-	-	-	-	-	-	-	-	-	-
	T8330	0.8	130	0.17	0.8	90	0.15	0.8	105	0.17	0.8	-	-	-	-	-	-	-
	T8430	0.8	130	0.17	0.8	90	0.15	0.8	105	0.17	0.8	-	-	-	-	-	-	-
	T9325	0.8	130	0.17	0.8	100	0.15	0.8	105	0.17	0.8	-	-	-	-	-	-	-

TCMW



	IC (mm)	D1 (mm)	L (mm)	S (mm)
16T3	9.525	4.40	16.50	3.97

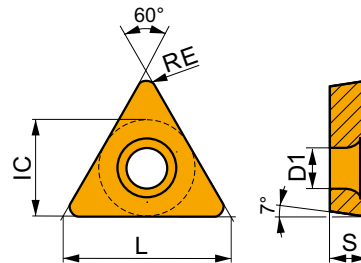

Valores de inicio adecuados para la velocidad de corte (vc), avance (f) y profundidad de corte (ap). Consulte nuestra APP Calculadora de mecanizado para obtener más cálculos.

Producto	RE (mm)	P			M			K			N			S			H		
		vc (m/min)	f (mm/rev)	ap (mm)	vc (m/min)	f (mm/rev)	ap (mm)	vc (m/min)	f (mm/rev)	ap (mm)	vc (m/min)	f (mm/rev)	ap (mm)	vc (m/min)	f (mm/rev)	ap (mm)	vc (m/min)	f (mm/rev)	ap (mm)

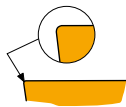

Para acabado fino a semi-desbaste con corte continuo y ligeramente interrumpido.

TCMW 16T304	T5305	0.4	-	-	-	-	-	-	115	0.10	1.5	-	-	-	-	-	-	30	0.15	1.0
	T5315	0.4	-	-	-	-	-	-	115	0.10	1.5	-	-	-	-	-	-	26	0.15	1.0
	T6310	0.4	-	-	-	-	-	-	85	0.10	1.5	-	-	-	-	-	-	15	0.15	1.0
TCMW 16T308	T5305	0.8	-	-	-	-	-	-	105	0.18	1.5	-	-	-	-	-	-	30	0.15	1.0
	T5315	0.8	-	-	-	-	-	-	105	0.18	1.5	-	-	-	-	-	-	26	0.15	1.0
	T6310	0.8	-	-	-	-	-	-	85	0.18	1.5	-	-	-	-	-	-	15	0.15	1.0



CONOS PORTAHERRAMIENTAS



CONOS PORTAHERRAMIENTAS - DESCRIPCIÓN

1	2	3	4	5
AS 3	30	022	100	R

1		2	3	4		5	
Tipo de cono		Cono	Tamaño	Longitud PM		Variante	
AS 3	DIN 69871	30	022	055	55 mm	R	Refrigeración interna
BT 3	MAS BT	40	027	100	100 mm		
HSK	HSK	63A	032				
OTT 3	DIN 2080	50	042				
3	MORSE	05	054				
B	WELDON	25	068				
P	EXTENSIÓN		085				
R	REDUCCIÓN		100				
ADT	ADAPTADOR		200				
			300				
			400				
			500				



69871-BS



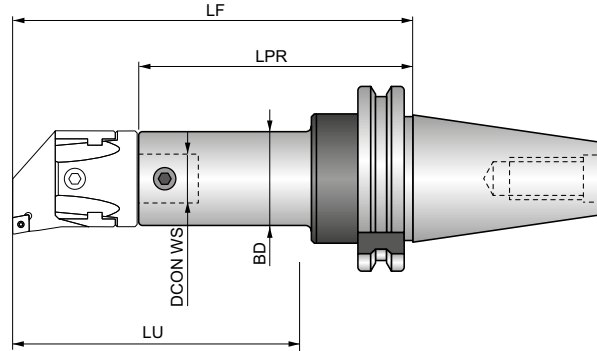

Portaherramientas de Mango DIN 69871-BS para Cabezas de Mandrinar

Portaherramientas de alta rigidez DIN 69871 (para ATC) para cabezas de mandrinar con cono 30, 40 y 50. Diferentes longitudes disponibles. Los tamaños de acoplamiento de 22 a 160 mm se pueden utilizar en combinación con extensores EXT-BS, reductores RED-BS y ampliadores LA-BS. Refrigeración interna disponible. Para aplicaciones que requieren alta precisión y repetibilidad.



Producto		CZC MS	BD	DCON WS	LF	LPR	LU			
			(mm)	(mm)	(mm)	(mm)	(mm)			kg
AS 330 022 100 R	30	22	22.00	12.00	138.00	104	100.00	✓	US 0608	0.72
AS 330 027 055 R	30	27	27.00	15.00	90.00	48	55.00	✓	US 0609	0.56
AS 330 027 100 R	30	27	27.00	15.00	138.00	96	100.00	✓	US 0609	0.68
AS 330 032 060 R	30	32	32.00	20.00	96.00	51	60.00	✓	US 0810	0.51
AS 330 032 100 R	30	32	32.00	20.00	138.00	93	100.00	✓	US 0810	0.74
AS 340 022 080 R	40	22	22.00	12.00	118.00	84	80.00	✓	US 0608	1.14
AS 340 022 100 R	40	22	22.00	12.00	138.00	104	100.00	✓	US 0608	1.24
AS 340 027 055 R	40	27	27.00	15.00	90.00	48	55.00	✓	US 0609	1.05
AS 340 027 100 R	40	27	27.00	15.00	138.00	96	100.00	✓	US 0609	1.30
AS 340 027 130 R	40	27	27.00	15.00	168.00	126	130.00	✓	US 0609	1.43
AS 340 032 060 R	40	32	32.00	20.00	96.00	51	60.00	✓	US 0810	1.10
AS 340 032 100 R	40	32	32.00	20.00	138.00	93	100.00	✓	US 0810	1.35
AS 340 032 130 R	40	32	32.00	20.00	168.00	123	130.00	✓	US 0810	1.52
AS 340 042 075 R	40	42	42.00	24.00	112.00	56	75.00	✓	US 1014	1.16
AS 340 042 160 R	40	42	42.00	24.00	182.00	126	160.00	✓	US 1014	1.90
AS 340 042 200 R	40	42	42.00	24.00	222.00	166	200.00	✓	US 1014	2.37
AS 340 054 120 R	40	54	54.00	28.00	142.00	76	120.00	✓	US 1219	1.58
AS 340 054 160 R	40	54	54.00	28.00	182.00	116	160.00	✓	US 1219	2.28
AS 340 054 200 R	40	54	54.00	28.00	222.00	156	200.00	✓	US 1219	2.93
AS 340 068 160 R	40	68	68.00	36.00	183.00	97	160.00	✓	US 1625	2.36
AS 340 068 200 R	40	68	68.00	36.00	223.00	137	200.00	✓	US 1625	3.50
AS 340 085 200 R	40	85	85.00	50.00	224.00	124	200.00	✓	US 1630	3.96
AS 340 100 200 R	40	100, 200	100.00	60.00	224.00	124	200.00	✓	US 2032	5.21
AS 350 022 080 R	50	22	22.00	12.00	118.00	84	80.00	✓	US 0608	3.43
AS 350 022 100 R	50	22	22.00	12.00	138.00	104	100.00	✓	US 0608	3.40
AS 350 027 055 R	50	27	27.00	15.00	90.00	48	55.00	✓	US 0609	3.30
AS 350 027 100 R	50	27	27.00	15.00	138.00	96	100.00	✓	US 0609	3.48
AS 350 027 130 R	50	27	27.00	15.00	168.00	126	130.00	✓	US 0609	3.48
AS 350 032 060 R	50	32	32.00	20.00	96.00	51	60.00	✓	US 0810	2.98
AS 350 032 130 R	50	32	32.00	20.00	168.00	123	130.00	✓	US 0810	3.71
AS 350 032 160 R	50	32	32.00	20.00	198.00	153	160.00	✓	US 0810	3.95
AS 350 042 075 R	50	42	42.00	24.00	112.00	56	75.00	✓	US 1014	3.32
AS 350 042 160 R	50	42	42.00	24.00	198.00	142	160.00	✓	US 1014	4.26
AS 350 042 200 R	50	42	42.00	24.00	238.00	182	200.00	✓	US 1014	4.74



Producto		CZC MS	BD	DCON WS	LF	LPR	LU			
			(mm)	(mm)	(mm)	(mm)	(mm)			
AS 350 054 090 R	50	54	54.00	28.00	128.00	62	90.00	✓	US 1219	3.39
AS 350 054 160 R	50	54	54.00	28.00	198.00	132	160.00	✓	US 1219	4.74
AS 350 054 200 R	50	54	54.00	28.00	238.00	172	200.00	✓	US 1219	5.48
AS 350 068 115 R	50	68	68.00	36.00	151.00	65	115.00	✓	US 1625	3.66
AS 350 068 200 R	50	68	68.00	36.00	223.00	137	200.00	✓	US 1625	5.81
AS 350 068 260 R	50	68	68.00	36.00	283.00	197	260.00	✓	US 1625	7.48
AS 350 085 200 R	50	85	85.00	50.00	224.00	124	200.00	✓	US 1630	6.21
AS 350 085 260 R	50	85	85.00	50.00	284.00	184	260.00	✓	US 1630	8.91
AS 350 085 320 R	50	85	85.00	50.00	344.00	244	320.00	✓	US 1630	11.50
AS 350 100 190 R	50	100, 200	100.00	60.00	214.00	114	190.00	✓	US 2032	6.52
AS 350 100 260 R	50	100, 200	100.00	60.00	284.00	184	260.00	✓	US 2032	10.85
AS 350 100 320 R	50	100, 200	100.00	60.00	344.00	244	320.00	✓	US 2032	14.47
AS 550 160	50	300, 400, 500	100.00	60.00	160.00	70	125.00	–	US 1240	5.55



BT-BS





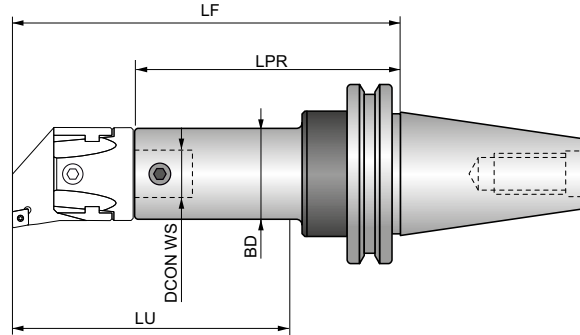

Portaherramientas MAS 403-BT para Cabezas de Mandrinar

Portaherramientas de alta rigidez MAS 403-BT (para ATC) para cabezas de mandrinar, disponible en conos de 30, 40 y 50. Diferentes longitudes disponibles. Los acoplamientos de 22-160 mm se pueden utilizar con extensores EXT-BS, reductores RED-BS y ampliadores LA-BS. Refrigeración interna disponible. Para aplicaciones que requieren alta precisión y repetibilidad.



Producto		CZC MS	BD	DCON WS	LF	LPR	LU			
			(mm)	(mm)	(mm)	(mm)	(mm)			kg
BT 330 022 100 R	30	22	22.00	12.00	125.00	91	100.00	✓	US 0608	0.56
BT 330 027 055 R	30	27	27.00	15.00	77.00	35	55.00	✓	US 0609	0.41
BT 330 027 100 R	30	27	27.00	15.00	125.00	83	100.00	✓	US 0609	0.69
BT 330 032 060 R	30	32	32.00	20.00	83.00	38	60.00	✓	US 0810	0.47
BT 330 032 100 R	30	32	32.00	20.00	125.00	80	100.00	✓	US 0810	0.70
BT 330 042 075 R	30	42	42.00	24.00	100.00	44	75.00	✓	US 1014	0.56
BT 340 022 050 R	40	22	22.00	12.00	80.00	46	50.00	✓	US 0608	1.02
BT 340 022 080 R	40	22	22.00	12.00	110.00	76	80.00	✓	US 0608	1.16
BT 340 022 100 R	40	22	22.00	12.00	130.00	96	100.00	✓	US 0608	1.14
BT 340 027 055 R	40	27	27.00	15.00	82.00	40	55.00	✓	US 0609	1.06
BT 340 027 100 R	40	27	27.00	15.00	130.00	88	100.00	✓	US 0609	1.26
BT 340 027 130 R	40	27	27.00	15.00	160.00	118	130.00	✓	US 0609	1.39
BT 340 032 060 R	40	32	32.00	20.00	88.00	43	60.00	✓	US 0810	1.00
BT 340 032 100 R	40	32	32.00	20.00	130.00	85	100.00	✓	US 0810	1.31
BT 340 032 130 R	40	32	32.00	20.00	160.00	115	130.00	✓	US 0810	1.50
BT 340 042 075 R	40	42	42.00	24.00	104.00	48	75.00	✓	US 1014	1.14
BT 340 042 160 R	40	42	42.00	24.00	190.00	134	160.00	✓	US 1014	2.05
BT 340 042 200 R	40	42	42.00	24.00	230.00	174	200.00	✓	US 1014	2.39
BT 340 054 090 R	40	54	54.00	28.00	120.00	54	90.00	✓	US 1219	1.13
BT 340 054 160 R	40	54	54.00	28.00	190.00	124	160.00	✓	US 1219	2.55
BT 340 054 200 R	40	54	54.00	28.00	230.00	164	200.00	✓	US 1219	3.10
BT 340 068 160 R	40	68	68.00	36.00	181.00	95	160.00	✓	US 1625	2.46
BT 340 068 200 R	40	68	68.00	36.00	221.00	135	200.00	✓	US 1625	3.64
BT 340 085 200 R	40	85	85.00	50.00	220.00	120	200.00	✓	US 1630	4.04
BT 340 100 200 R	40	100	100.00	60.00	220.00	120	200.00	✓	US 2032	4.95
BT 350 022 080 R	50	22	22.00	12.00	121.00	87	80.00	✓	US 0608	3.95
BT 350 022 100 R	50	22	22.00	12.00	141.00	107	100.00	✓	US 0608	3.50
BT 350 027 055 R	50	27	27.00	15.00	93.00	51	55.00	✓	US 0609	3.68
BT 350 027 100 R	50	27	27.00	15.00	141.00	99	100.00	✓	US 0609	4.00
BT 350 027 130 R	50	27	27.00	15.00	171.00	129	130.00	✓	US 0609	4.14
BT 350 032 060 R	50	32	32.00	20.00	99.00	54	60.00	✓	US 0810	3.67
BT 350 032 130 R	50	32	32.00	20.00	171.00	126	130.00	✓	US 0810	4.24
BT 350 032 160 R	50	32	32.00	20.00	201.00	156	160.00	✓	US 0810	4.56
BT 350 042 075 R	50	42	42.00	24.00	115.00	59	75.00	✓	US 1014	3.84



Producto		CZC MS	BD	DCON WS	LF	LPR	LU			
			(mm)	(mm)	(mm)	(mm)	(mm)			
BT 350 042 160 R	50	42	42.00	24.00	201.00	145	160.00	✓	US 1014	4.89
BT 350 042 200 R	50	42	42.00	24.00	241.00	185	200.00	✓	US 1014	5.25
BT 350 054 090 R	50	54	54.00	28.00	131.00	65	90.00	✓	US 1219	3.90
BT 350 054 160 R	50	54	54.00	28.00	201.00	135	160.00	✓	US 1219	5.39
BT 350 054 200 R	50	54	54.00	28.00	241.00	175	200.00	✓	US 1219	5.98
BT 350 068 115 R	50	68	68.00	36.00	154.00	68	115.00	✓	US 1625	4.09
BT 350 068 200 R	50	68	68.00	36.00	242.00	156	200.00	✓	US 1625	6.66
BT 350 068 260 R	50	68	68.00	36.00	302.00	216	260.00	✓	US 1625	8.18
BT 350 085 200 R	50	85	85.00	50.00	242.00	142	200.00	✓	US 1630	7.40
BT 350 085 260 R	50	85	85.00	50.00	302.00	202	260.00	✓	US 1630	9.89
BT 350 085 320 R	50	85	85.00	50.00	362.00	262	320.00	✓	US 1630	12.76
BT 350 100 170 R	50	100, 200	100.00	60.00	195.00	95	170.00	✓	US 2032	5.71
BT 350 100 260 R	50	100, 200	100.00	60.00	302.00	202	260.00	✓	US 2032	12.34
BT 350 100 320 R	50	100, 200	100.00	60.00	362.00	262	320.00	✓	US 2032	14.50
BT 550 160	50	300, 400, 500	100.00	60.00	160.00	70	125.00	–	US 1240	6.05



HSK-BS



Portaherramientas HSK para Cabezas de Mandrinar

Portaherramientas HSK de alta rigidez (para ATC) para cabezas de mandrinar, disponible en cono 50A, 63A o 100A. Los tamaños de acoplamiento de 22 a 160 mm se pueden utilizar en combinación con extensores EXT-BS, reductores RED-BS y ampliadores LA-BS. Refrigeración interna disponible. Para aplicaciones que requieren alta precisión y repetibilidad.

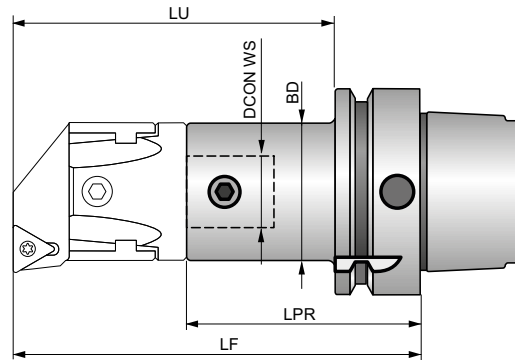

Producto		CZC MS	BD	DCON WS	LF	LPR	LU			
			(mm)	(mm)	(mm)	(mm)	(mm)			kg
HSK 050A 022 055	50	22	22.00	12.00	81.00	47	55.00	—	US 0608	0.49
HSK 050A 027 065	50	27	27.00	15.00	91.00	49	65.00	—	US 0609	0.49
HSK 050A 032 075	50	32	32.00	20.00	101.00	56	75.00	—	US 0810	0.66
HSK 050A 042 090	50	42	42.00	24.00	116.00	60	90.00	—	US 1014	0.71
HSK 063A 022 055	63	22	22.00	12.00	81.00	47	55.00	—	US 0608	0.07
HSK 063A 027 065	63	27	27.00	15.00	91.00	49	65.00	—	US 0609	0.76
HSK 063A 032 075	63	32	32.00	20.00	101.00	56	75.00	—	US 0810	0.82
HSK 063A 042 090	63	42	42.00	24.00	116.00	60	90.00	—	US 1014	0.96
HSK 063A 054 110	63	54	54.00	28.00	136.00	70	110.00	—	US 1219	1.26
HSK 063A 068 145	63	68	68.00	36.00	171.00	85	145.00	—	US 1625	1.81
HSK 100A 022 055	100	22	22.00	12.00	89.00	55	55.00	—	US 0608	2.28
HSK 100A 027 065	100	27	27.00	15.00	99.00	57	65.00	—	US 0609	2.34
HSK 100A 032 075	100	32	32.00	20.00	104.00	59	75.00	—	US 0810	2.73
HSK 100A 042 090	100	42	42.00	24.00	119.00	63	90.00	—	US 1014	2.45
HSK 100A 054 110	100	54	54.00	28.00	139.00	73	110.00	—	US 1219	2.79
HSK 100A 068 145	100	68	68.00	36.00	174.00	88	145.00	—	US 1625	3.52
HSK 100A 085 165	100	85	85.00	50.00	194.00	94	165.00	—	US 1630	4.15
HSK 100A 100 185	100	100, 200	100.00	60.00	214.00	114	185.00	—	US 2032	5.63
HSK 550 160	100	300, 400, 500	100.00	60.00	170.00	80	140.00	—	US 1240	5.24



2080-BS





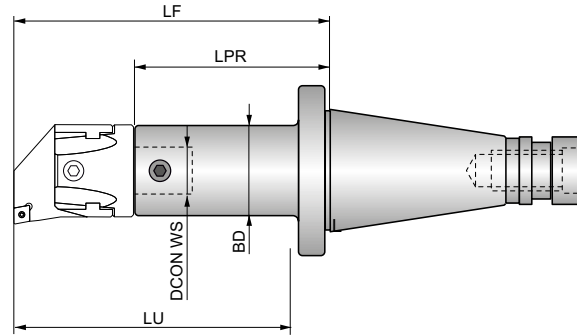

Portaherramientas de Mango DIN 2080 para Cabezas de Mandrinar

Portaherramientas de alta rigidez DIN 2080 (para MTC) para cabezas de mandrinar con cono 40 y 50. Diferentes longitudes disponibles. Los tamaños de acoplamiento de 22 a 160 mm se pueden utilizar en combinación con extensores EXT-BS, reductores RED-BS y ampliadores LA-BS. Refrigeración interna disponible. Para aplicaciones que requieren alta precisión y repetibilidad.



Producto	CZC MS	BD	DCON WS	LF	LPR	LU	✓	US	kg	
										(mm)
OTT 340 022 080 R	40	22	22.00	12.00	95.00	61	80.00	✓	US 0608	0.88
OTT 340 022 100 R	40	22	22.00	12.00	115.00	81	100.00	✓	US 0608	0.94
OTT 340 027 055 R	40	27	27.00	15.00	67.00	25	55.00	✓	US 0609	0.86
OTT 340 027 100 R	40	27	27.00	15.00	115.00	73	100.00	✓	US 0609	1.00
OTT 340 027 130 R	40	27	27.00	15.00	145.00	103	130.00	✓	US 0609	1.12
OTT 340 032 060 R	40	32	32.00	20.00	73.00	28	60.00	✓	US 0810	0.90
OTT 340 032 100 R	40	32	32.00	20.00	115.00	70	100.00	✓	US 0810	1.10
OTT 340 032 130 R	40	32	32.00	20.00	145.00	100	130.00	✓	US 0810	1.22
OTT 340 042 075 R	40	42	42.00	24.00	89.00	33	75.00	✓	US 1014	0.89
OTT 340 042 160 R	40	42	42.00	24.00	175.00	119	160.00	✓	US 1014	1.73
OTT 340 042 200 R	40	42	42.00	24.00	215.00	159	200.00	✓	US 1014	2.30
OTT 340 054 090 R	40	54	54.00	28.00	105.00	39	90.00	✓	US 1219	1.08
OTT 340 054 160 R	40	54	54.00	28.00	175.00	109	160.00	✓	US 1219	2.23
OTT 340 054 200 R	40	54	54.00	28.00	215.00	149	200.00	✓	US 1219	3.06
OTT 340 068 160 R	40	68	68.00	36.00	175.00	90	160.00	✓	US 1625	2.40
OTT 340 068 200 R	40	68	68.00	36.00	216.00	130	200.00	✓	US 1625	3.73
OTT 340 085 200 R	40	85	85.00	50.00	211.00	111	200.00	✓	US 1630	4.03
OTT 340 100 200 R	40	100, 200	100.00	60.00	211.00	111	200.00	✓	US 2032	5.05
OTT 350 022 080 R	50	22	22.00	12.00	99.00	65	80.00	✓	US 0608	2.98
OTT 350 022 100 R	50	22	22.00	12.00	119.00	85	100.00	✓	US 0608	2.97
OTT 350 027 055 R	50	27	27.00	15.00	71.00	29	55.00	✓	US 0609	2.93
OTT 350 027 100 R	50	27	27.00	15.00	119.00	77	100.00	✓	US 0609	3.01
OTT 350 027 130 R	50	27	27.00	15.00	149.00	107	130.00	✓	US 0609	3.10
OTT 350 032 060 R	50	32	32.00	20.00	77.00	32	60.00	✓	US 0810	2.81
OTT 350 032 130 R	50	32	32.00	20.00	149.00	104	130.00	✓	US 0810	3.24
OTT 350 032 160 R	50	32	32.00	20.00	179.00	134	160.00	✓	US 0810	3.26
OTT 350 042 075 R	50	42	42.00	24.00	93.00	37	75.00	✓	US 1014	2.74
OTT 350 042 160 R	50	42	42.00	24.00	179.00	123	160.00	✓	US 1014	3.64
OTT 350 042 200 R	50	42	42.00	24.00	219.00	163	200.00	✓	US 1014	4.05
OTT 350 054 090 R	50	54	54.00	28.00	109.00	43	90.00	✓	US 1219	3.02
OTT 350 054 160 R	50	54	54.00	28.00	179.00	113	160.00	✓	US 1219	4.15
OTT 350 054 200 R	50	54	54.00	28.00	219.00	153	200.00	✓	US 1219	5.08
OTT 350 068 115 R	50	68	68.00	36.00	132.00	46	115.00	✓	US 1625	3.20
OTT 350 068 200 R	50	68	68.00	36.00	220.00	134	200.00	✓	US 1625	5.54



Producto		CZC MS	BD	DCON WS	LF	LPR	LU			
			(mm)	(mm)	(mm)	(mm)	(mm)			
OTT 350 068 260 R	50	68	68.00	36.00	280.00	194	260.00	✓	US 1625	7.22
OTT 350 085 200 R	50	85	85.00	50.00	221.00	121	200.00	✓	US 1630	6.21
OTT 350 085 260 R	50	85	85.00	50.00	281.00	181	260.00	✓	US 1630	9.07
OTT 350 085 320 R	50	85	85.00	50.00	341.00	241	320.00	✓	US 1630	11.84
OTT 350 100 170 R	50	100, 200	100.00	60.00	193.00	93	170.00	✓	US 2032	5.60
OTT 350 100 260 R	50	100, 200	100.00	60.00	281.00	181	260.00	✓	US 2032	10.78
OTT 350 100 320 R	50	100, 200	100.00	60.00	341.00	241	320.00	✓	US 2032	15.10
OTT 550 160	50	300, 400, 500	100.00	60.00	160.00	70	125.00	–	US 1240	5.90



MOR-BS



Portaherramientas de Mango Cónico (CM) para Cabezas de Mandrinar

Portaherramientas de gran rigidez con cono Morse 5 para cabezas de mandrinado. Acoplamientos de diferentes longitudes disponibles. Los tamaños de acoplamiento de 22 a 160 mm se pueden utilizar en combinación con extensores EXT-BS, reductores RED-BS y alargadores LA-BS. Disponible con refrigeración interna. Para aplicaciones que requieren alta precisión y repetibilidad.

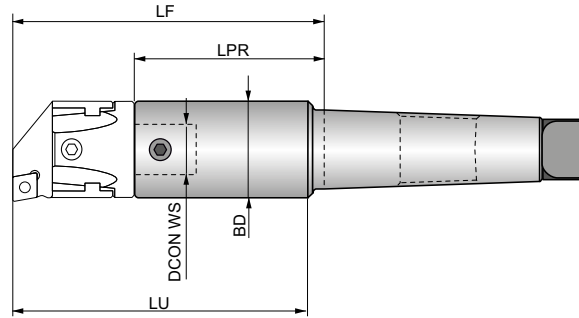

Producto	CCTMS	CZC MS	BD	DCON WS	LF	LPR	LU			
			(mm)	(mm)	(mm)	(mm)	(mm)			kg
305 022 100	5	22	22.00	12.00	112.00	78	100.00	–	US 0608	1.64
305 022 130	5	22	22.00	12.00	142.00	108	130.00	–	US 0608	1.76
305 027 055	5	27	27.00	15.00	65.00	23	55.00	–	US 0609	1.58
305 027 100	5	27	27.00	15.00	113.00	71	100.00	–	US 0609	1.69
305 027 130	5	27	27.00	15.00	143.00	101	130.00	–	US 0609	1.84
305 032 060	5	32	32.00	20.00	70.00	25	60.00	–	US 0810	1.54
305 032 130	5	32	32.00	20.00	143.00	98	130.00	–	US 0810	1.95
305 032 160	5	32	32.00	20.00	173.00	128	160.00	–	US 0810	2.13
305 042 075	5	42	42.00	24.00	83.00	27	75.00	–	US 1014	1.50
305 042 130	5	42	42.00	24.00	188.00	86	130.00	–	US 1014	2.18
305 042 160	5	42	42.00	24.00	218.00	116	160.00	–	US 1014	2.51
305 054 160	5	54	54.00	28.00	172.00	106	160.00	–	US 1219	3.00
305 054 200	5	54	54.00	28.00	212.00	146	200.00	–	US 1219	3.63
305 068 140	5	68	68.00	36.00	146.00	60	140.00	–	US 1625	2.53
305 068 200	5	68	68.00	36.00	212.00	126	200.00	–	US 1625	4.47
305 068 260	5	68	68.00	36.00	272.00	186	260.00	–	US 1625	6.20
305 085 200	5	85	85.00	50.00	216.00	116	200.00	–	US 1630	5.40
305 085 260	5	85	85.00	50.00	276.00	176	260.00	–	US 1630	8.45
305 085 320	5	85	85.00	50.00	336.00	236	320.00	–	US 1630	0.01
305 100 260	5	100, 200	100.00	60.00	276.00	176	260.00	–	US 2032	7.95
305 100 320	5	100, 200	100.00	60.00	336.00	236	320.00	–	US 2032	11.39
505 160	5	300, 400, 500	100.00	60.00	146.00	56	140.00	–	US 2032	4.70







WEL-BS

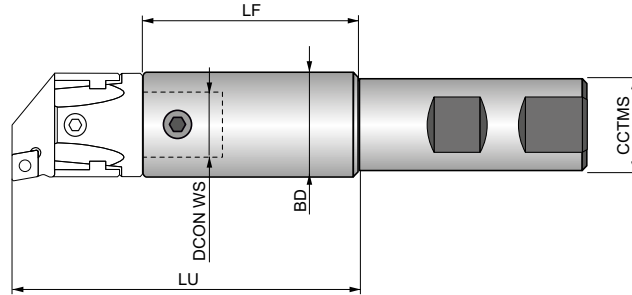

Portaherramientas Mango WELDON para Cabezas de Mandrinar

Portaherramientas Weldon de alta rigidez para cabezas de mandrinado, diámetros de mango de 20 a 40 mm. Diferentes longitudes disponibles. Los tamaños de acoplamiento de 22 a 42 mm se pueden utilizar en combinación con los extensores EXT-BS y los reductores RED-BS. Refrigeración interna disponible. Para aplicaciones que requieren alta precisión y repetibilidad.



Producto	CCTMS	CZC MS	BD	DCON WS	LU			
			(mm)	(mm)	(mm)			kg
B 020 022 050	20	22	22.00	12.00	50.00	–	US 0608	0.17
B 020 022 100	20	22	22.00	12.00	100.00	–	US 0608	0.34
B 025 027 055	25	27	27.00	15.00	55.00	–	US 0609	0.17
B 025 027 100	25	27	27.00	15.00	95.00	–	US 0609	0.46
B 032 032 060	32	32	32.00	20.00	60.00	–	US 0810	0.43
B 032 032 100	32	32	32.00	20.00	100.00	–	US 0810	0.69
B 032 032 160	32	32	32.00	20.00	160.00	–	US 0810	1.11
B 032 042 090	32	32	32.00	24.00	90.00	–	US 0810	0.71
B 040 042 090	40	42	42.00	24.00	90.00	–	US 1014	0.98
B 040 042 160	40	42	42.00	24.00	160.00	–	US 1014	1.79



EXT-BS



Adaptador de Extensión EXT-BS para Cabeza de Mandrinar

Adaptador de extensión para cabeza de mandrinar. Tamaños de acoplamiento desde 22 hasta 200 mm y diferentes longitudes disponibles. Opciones de refrigeración interna y externa disponibles. Adecuado para todas las aplicaciones que requieren alta precisión y repetibilidad.

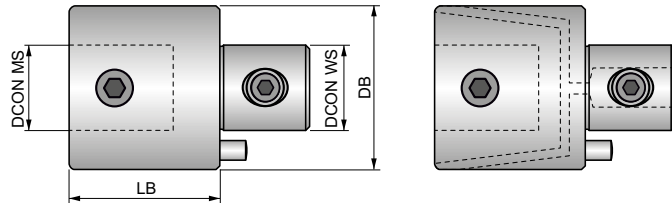

Producto	CZC MS	BD	DCON MS	DCON WS	LB			
		(mm)	(mm)	(mm)	(mm)			
P 022 030 R	22	22.00	12.00	12.00	30.00	✓	US 0608	0.09
P 027 030 R	27	27.00	15.00	15.00	30.00	✓	US 0609	0.13
P 032 035 R	32	32.00	20.00	20.00	35.00	✓	US 0810	0.20
P 042 040 R	42	42.00	24.00	24.00	40.00	✓	US 1014	0.40
P 054 050 R	54	54.00	28.00	28.00	50.00	✓	US 1219	0.85
P 068 060 R	68	68.00	36.00	36.00	60.00	✓	US 1625	1.61
P 085 070 R	85	85.00	50.00	50.00	70.00	✓	US 1630	2.88
P 100 080 R	100, 200	100.00	60.00	60.00	80.00	✓	US 2032	4.48
P 022 020	22	22.00	12.00	12.00	20.00	–	US 0608	0.06
P 022 030	22	22.00	12.00	12.00	30.00	–	US 0608	0.09
P 027 030	27	27.00	15.00	15.00	30.00	–	US 0609	0.13
P 027 045	27	27.00	15.00	15.00	45.00	–	US 0609	0.19
P 032 035	32	32.00	20.00	20.00	35.00	–	US 0810	0.20
P 032 052	32	32.00	20.00	20.00	52.00	–	US 0810	0.30
P 042 040	42	42.00	24.00	24.00	40.00	–	US 1014	0.40
P 042 060	42	42.00	24.00	24.00	60.00	–	US 1014	0.60
P 054 050	54	54.00	28.00	28.00	50.00	–	US 1219	0.87
P 054 075	54	54.00	28.00	28.00	75.00	–	US 1219	1.30
P 068 060	68	68.00	36.00	36.00	60.00	–	US 1625	1.63
P 068 090	68	68.00	36.00	36.00	90.00	–	US 1625	2.44
P 085 070	85	85.00	50.00	50.00	70.00	–	US 1630	2.86
P 085 105	85	85.00	50.00	50.00	105.00	–	US 1630	4.46
P 100 080	100, 200	100.00	60.00	60.00	80.00	–	US 2032	4.44
P 100 120	100, 200	100.00	60.00	60.00	120.00	–	US 2032	6.91



RED-BS



Adaptador de Reducción RED-BS para Cabeza de Mandrinar

Adaptador reductor para cabeza de mandrinar. Tamaños de acoplamiento desde 27 hasta 100 mm y diferentes longitudes disponibles. Solo refrigeración externa. Adecuado para todas las aplicaciones que requieren alta precisión y repetibilidad.

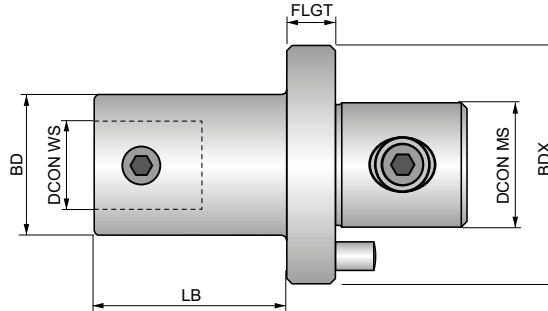

Producto	CZC MS	BDX	DCON MS	BD	DCON WS	LB	FLGT			
		(mm)	(mm)	(mm)	(mm)	(mm)	(mm)			
R 027 022 036	22	27.00	15.00	22	12.00	26.00	10	—	US 0608	0.11
R 042 022 058	22	42.00	24.00	22	12.00	48.00	10	—	US 0608	0.31
R 032 022 040	22	32.00	20.00	22	12.00	30.00	10	—	US 0608	0.17
R 054 022 086	22	54.00	28.00	22	12.00	76.00	10	—	US 0608	0.51
R 068 022 102	22	68.00	36.00	22	12.00	90.00	12	—	US 0608	0.90
R 054 027 080	27	54.00	28.00	27	15.00	70.00	10	—	US 0609	0.63
R 032 027 034	27	32.00	20.00	27	15.00	24.00	10	—	US 0609	0.18
R 042 027 050	27	42.00	24.00	27	15.00	40.00	10	—	US 0609	0.33
R 068 027 095	27	68.00	36.00	27	15.00	83.00	12	—	US 0609	0.97
R 042 032 046	32	42.00	24.00	32	20.00	36.00	10	—	US 0810	0.36
R 054 032 076	32	54.00	28.00	32	20.00	66.00	10	—	US 0810	0.63
R 068 032 090	32	68.00	36.00	32	20.00	78.00	12	—	US 0810	1.08
R 054 042 070	42	54.00	28.00	42	24.00	60.00	10	—	US 1014	0.81
R 068 042 082	42	68.00	36.00	42	24.00	70.00	12	—	US 1014	1.26
R 085 042 095	42	85.00	50.00	42	24.00	83.00	12	—	US 1014	2.06
R 068 054 072	54	68.00	36.00	54	28.00	60.00	12	—	US 1219	1.51
R 085 054 090	54	85.00	50.00	54	28.00	78.00	12	—	US 1219	2.44
R 085 068 100	68	85.00	50.00	68	36.00	88.00	12	—	US 1625	3.32
R 100 085 100	85	100.00	60.00	85	50.00	88.00	12	—	US 1630	5.05



LA-BS



Alargador para Cabeza de Mandrinar LA-BS

Adaptador de ampliación para cabeza de mandrinar. Disponible en tamaño de acoplamiento 100 mm y en diferentes longitudes para aumentar la versatilidad. Solo refrigeración externa. Adecuado para todas las aplicaciones que requieren alta precisión y repetibilidad.

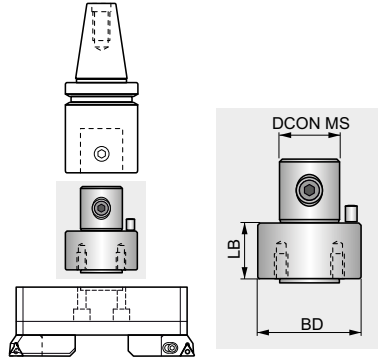

Producto	CZC MS	BD (mm)	DCON MS (mm)	LB (mm)			
ADT 100 050	300, 400, 500	100.00	60.00	50.00	–	US 1240	4.35



KITS DE MANDRINADO



DESCRIPCIÓN KITS DE MANDRINADO

1	2	3	4	5
BS	54	KIT	RC	8-43

1		2	3	4		5
Tipo de herramienta		Tamaño	Tipo	Tipo de barra ISO		Gama de diámetros de agujero
BS	Sistemas de mandrinado	54	KIT	Juego de herramientas	RC	para plaquita forma C $\kappa = 95^\circ$
					TC	para plaquita forma T $\kappa = 90^\circ$
						8 – 43 (mm)
						8 – 100 (mm)
						8 – 170 (mm)
						8 – 210 (mm)

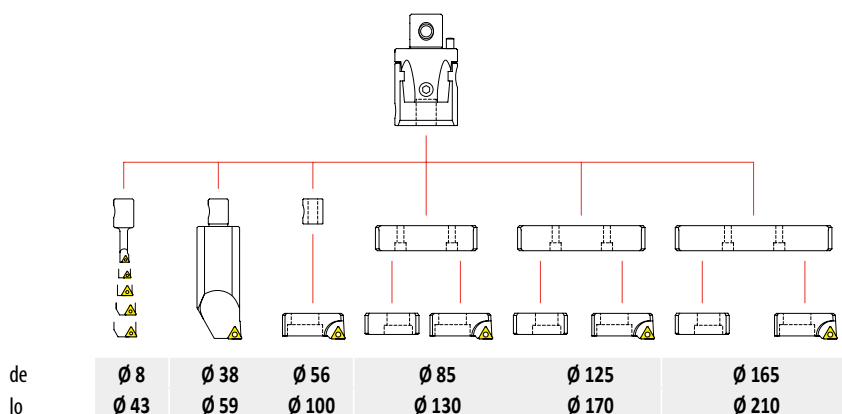

Rango	Componentes	Referencia	
Ø 8 ~ Ø 43		BS 54 KIT RC 8-043	420
		BS 54 KIT TC 8-043	424
Ø 8 ~ Ø 100		BS 54 KIT RC 8-100	421
		BS 54 KIT TC 8-100	425
Ø 8 ~ Ø 170		BS 54 KIT RC 8-170	422
		BS 54 KIT TC 8-170	426
Ø 8 ~ Ø 210		BS 54 KIT RC 8-210	423
		BS 54 KIT TC 8-210	427



BS 54 KIT RC 8-100

KITS DE MANDRINADO

Ø 8 – 100

NÚMERO DE PEDIDO:



	Descripción	Identificación	Plaquita	pieza
1	Cabezal	BS 054 16	-	1
2	Barrita mandrinar 6 mm	BS 06 16 R02	EP.. 0502..	1
	Barrita mandrinar 8 mm	BS 08 16 R03	CC.. 0602..	1
	Barrita mandrinar 10 mm	BS 10 16 R03	CC.. 0602..	1
	Barrita mandrinar 12 mm	BS 12 16 R03	CC.. 0602..	1
	Barrita mandrinar 16 mm	BS 16 16 R04	CC.. 09T3..	1
3	Barrita mandrinar 34 mm	BS 34 16 R04	CC.. 09T3..	2
4	Cartucho	BS 2CT R04	CC.. 09T3..	1
5	Casquillo de posicionamiento	BS 16 M10	-	1
6	Llave hexagonal 3	HK 03	-	1
	Llave hexagonal 5	HK 05	-	1
	Llave hexagonal 6	HK 06	-	1
	Llave hexagonal 8	HK 08	-	1
7	Llave torx 7	TK07	-	1
	Llave torx 8	TK08	-	1
	Llave torx 15	TK15	-	1
8	Tornillo de cartucho	CS 10 25	-	1



BS 54 KIT RC 8-170

KITS DE MANDRINADO

Ø 8 – 170

NÚMERO DE PEDIDO:

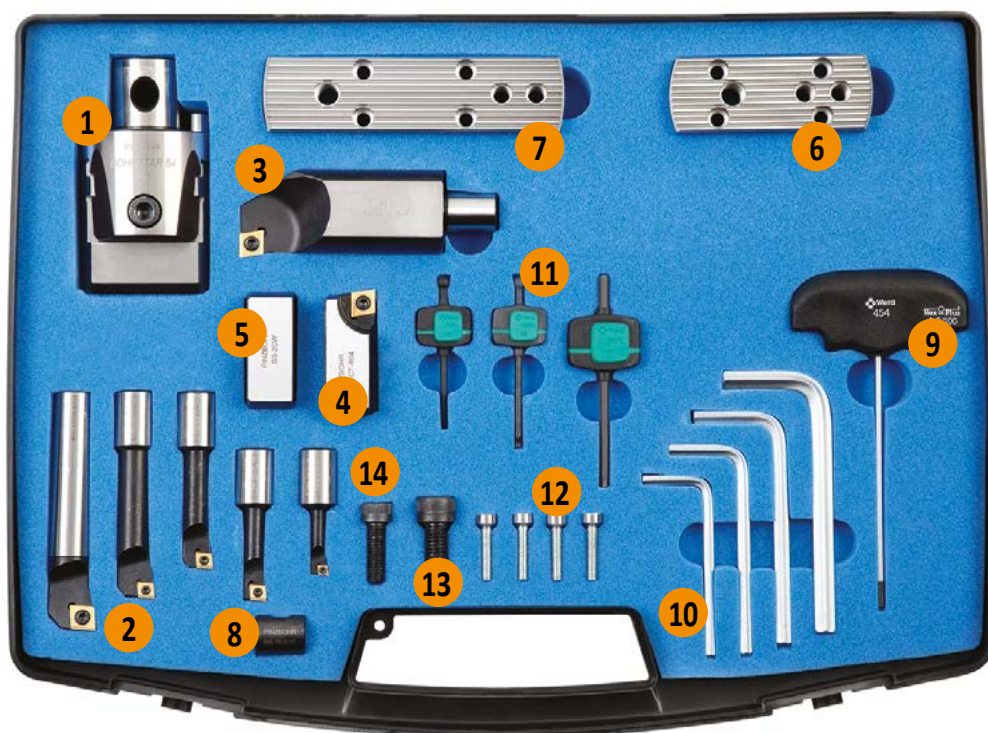

	Descripción	Identificación	Plaquita	pieza
1	Cabezal	BS 054 16	-	1
2	Barrita mandrinar 6 mm	BS 06 16 R02	EP.. 0502..	1
	Barrita mandrinar 8 mm	BS 08 16 R03	CC.. 0602..	1
	Barrita mandrinar 10 mm	BS 10 16 R03	CC.. 0602..	1
	Barrita mandrinar 12 mm	BS 12 16 R03	CC.. 0602..	1
	Barrita mandrinar 16 mm	BS 16 16 R04	CC.. 09T3..	1
3	Barrita mandrinar 34 mm	BS 34 16 R04	CC.. 09T3..	2
4	Cartucho	BS 2CT R04	CC.. 09T3..	1
5	Contrapeso	BS 2CW	-	1
6	Pletina pequeña	BS SP 85 130	-	1
7	Pletina mediana	BS SP 125 170	-	1
8	Casquillo de posicionamiento	BS 16 M10	-	1
9	Llave de reglaje	AK 03	-	1
10	Llave hexagonal 4	HK 04	-	1
	Llave hexagonal 5	HK 05	-	1
	Llave hexagonal 6	HK 06	-	1
	Llave hexagonal 8	HK 08	-	1
11	Llave torx 7	TK07	-	1
	Llave torx 8	TK08	-	1
	Llave torx 15	TK15	-	1
12	Tornillo fijación pletina	D 27 21	-	4
13	Tornillo de cartucho	CS 10 25	-	1
14	Tornillo del contrapeso	CS 08 25	-	1

∅ 8 – 210

NÚMERO DE PEDIDO:

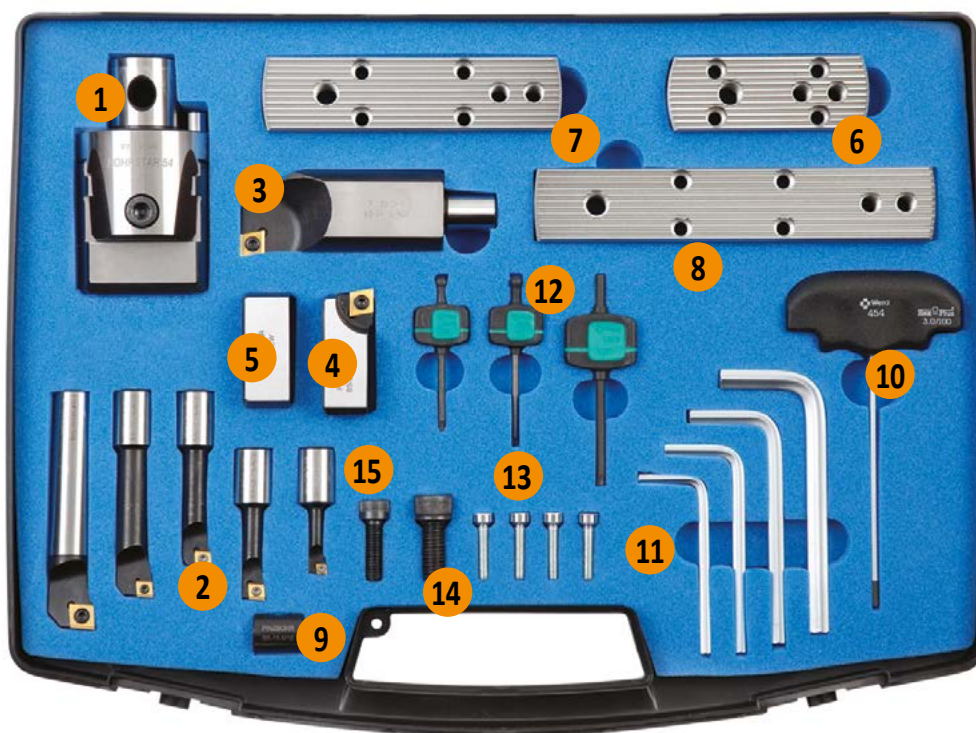

	Descripción	Identificación	Plaquita	pieza
1	Cabezal	BS 054 16	-	1
2	Barrita mandrinar 6 mm	BS 06 16 R02	EP.. 0502..	1
	Barrita mandrinar 8 mm	BS 08 16 R03	CC.. 0602..	1
	Barrita mandrinar 10 mm	BS 10 16 R03	CC.. 0602..	1
	Barrita mandrinar 12 mm	BS 12 16 R03	CC.. 0602..	1
	Barrita mandrinar 16 mm	BS 16 16 R04	CC.. 09T3..	1
3	Barrita mandrinar 34 mm	BS 34 16 R04	CC.. 09T3..	2
4	Cartucho	BS 2CT R04	CC.. 09T3..	1
5	Contrapeso	BS 2CW	-	1
6	Pletina pequeña	BS SP 85 130	-	1
7	Pletina mediana	BS SP 125 170	-	1
8	Pletina grande	BS SP 165 210	-	1
9	Casquillo de posicionamiento	BS 16 M10	-	1
10	Llave de reglaje	AK 03	-	1
11	Llave hexagonal 4	HK 04	-	1
	Llave hexagonal 5	HK 05	-	1
	Llave hexagonal 6	HK 06	-	1
	Llave hexagonal 8	HK 08	-	1
12	Llave torx 7	TK07	-	1
	Llave torx 8	TK08	-	1
	Llave torx 15	TK15	-	1
13	Tornillo fijación pletina	D 27 21	-	4
14	Tornillo de cartucho	CS 10 25	-	1
15	Tornillo del contrapeso	CS 08 25	-	1



BS 54 KIT TC 8-100

KITS DE MANDRINADO

Ø 8 – 100

NÚMERO DE PEDIDO:



	Descripción	Identificación	Plaquita	pieza
1	Cabezal	BS 054 16	-	1
2	Barrita mandrinar 6 mm	BS 06 16 T01	TC.. 06T1..	1
	Barrita mandrinar 8 mm	BS 08 16 T01	TC.. 06T1..	1
	Barrita mandrinar 10 mm	BS 10 16 T02	TC.. 0902..	1
	Barrita mandrinar 12 mm	BS 12 16 T02	TC.. 0902..	1
	Barrita mandrinar 16 mm	BS 16 16 T02	TC.. 0902..	1
3	Barrita mandrinar 34 mm	BS 34 16 T04	TC.. 16T3..	1
4	Cartucho	BS 2CT T04	TC.. 16T3..	1
5	Casquillo de posicionamiento	BS 16 M10	-	1
6	Llave hexagonal 3	HK 03	-	1
	Llave hexagonal 5	HK 05	-	1
	Llave hexagonal 6	HK 06	-	1
	Llave hexagonal 8	HK 08	-	1
7	Llave torx 6	TK06	-	1
	Llave torx 7	TK07	-	1
	Llave torx 15	TK15	-	1
8	Tornillo de cartucho	CS 10 25	-	1

BS 54 KIT TC 8-170

KITS DE MANDRINADO

∅ 8 – 170

NÚMERO DE PEDIDO:

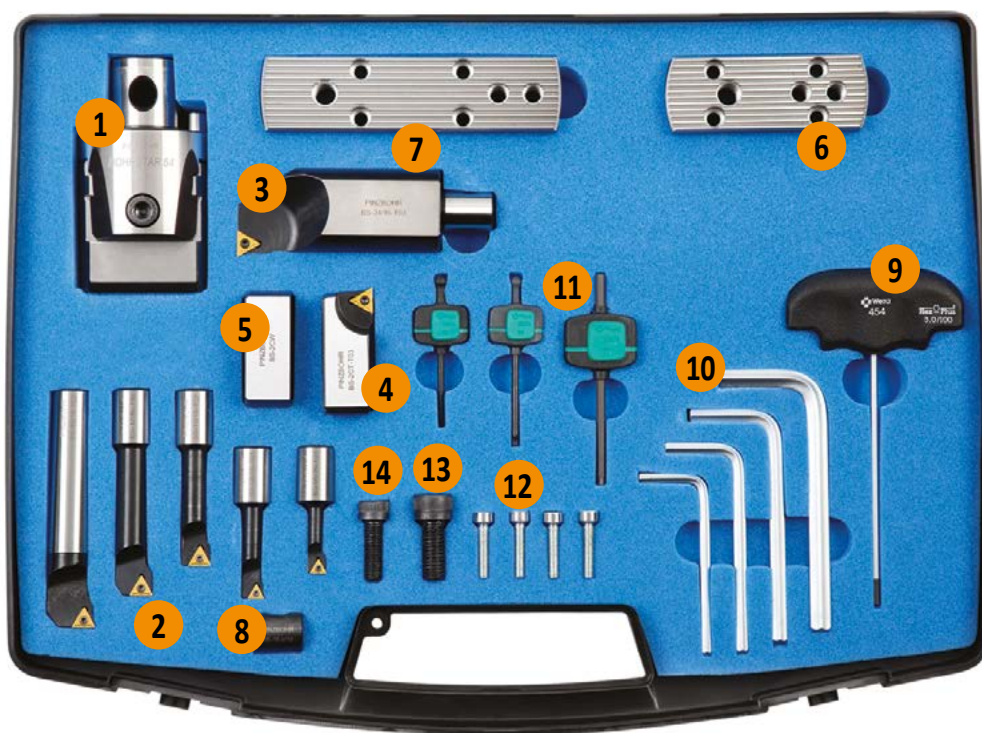

	Descripción	Identificación	Plaquita	pieza
1	Cabezal	BS 054 16	-	1
2	Barrita mandrinar 6 mm	BS 06 16 T01	TC.. 06T1..	1
	Barrita mandrinar 8 mm	BS 08 16 T01	TC.. 06T1..	1
	Barrita mandrinar 10 mm	BS 10 16 T02	TC.. 0902..	1
	Barrita mandrinar 12 mm	BS 12 16 T02	TC.. 0902..	1
	Barrita mandrinar 16 mm	BS 16 16 T02	TC.. 0902..	1
3	Barrita mandrinar 34 mm	BS 34 16 T04	TC.. 16T3..	1
4	Cartucho	BS 2CT T04	TC.. 16T3..	1
5	Contrapeso	BS 2CW	-	1
6	Pletina pequeña	BS SP 85 130	-	1
7	Pletina mediana	BS SP 125 170	-	1
8	Casquillo de posicionamiento	BS 16 M10	-	1
9	Llave de reglaje	AK 03	-	1
10	Llave hexagonal 4	HK 04	-	1
	Llave hexagonal 5	HK 05	-	1
	Llave hexagonal 6	HK 06	-	1
	Llave hexagonal 8	HK 08	-	1
11	Llave torx 6	TK06	-	1
	Llave torx 7	TK07	-	1
	Llave torx 15	TK15	-	1
12	Tornillo fijación pletina	D 27 21	-	4
13	Tornillo de cartucho	CS 10 25	-	1
14	Tornillo del contrapeso	CS 08 25	-	1

∅ 8 – 210

NÚMERO DE PEDIDO:

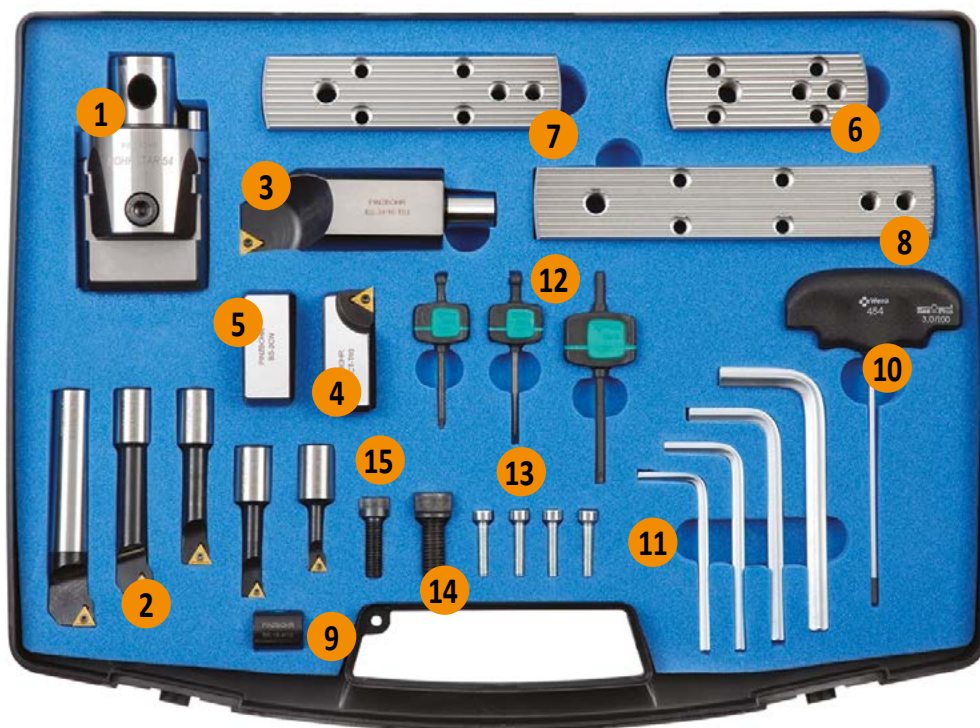

	Descripción	Identificación	Plaquita	pieza
1	Cabezal	BS 054 16	-	1
2	Barrita mandrinar 6 mm	BS 06 16 T01	TC.. 06T1..	1
	Barrita mandrinar 8 mm	BS 08 16 T01	TC.. 06T1..	1
	Barrita mandrinar 10 mm	BS 10 16 T02	TC.. 0902..	1
	Barrita mandrinar 12 mm	BS 12 16 T02	TC.. 0902..	1
	Barrita mandrinar 16 mm	BS 16 16 T02	TC.. 0902..	1
3	Barrita mandrinar 34 mm	BS 34 16 T04	TC.. 16T3..	1
4	Cartucho	BS 2CT T04	TC.. 16T3..	1
5	Contrapeso	BS 2CW	-	1
6	Pletina pequeña	BS SP 85 130	-	1
7	Pletina mediana	BS SP 125 170	-	1
8	Pletina grande	BS SP 165 210	-	1
9	Casquillo de posicionamiento	BS 16 M10	-	1
10	Llave de reglaje	AK 03	-	1
11	Llave hexagonal 4	HK 04	-	1
	Llave hexagonal 5	HK 05	-	1
	Llave hexagonal 6	HK 06	-	1
	Llave hexagonal 8	HK 08	-	1
12	Llave torx 6	TK06	-	1
	Llave torx 7	TK07	-	1
	Llave torx 15	TK15	-	1
13	Tornillo fijación pletina	D 27 21	-	4
14	Tornillo de cartucho	CS 10 25	-	1
15	Tornillo del contrapeso	CS 08 25	-	1



DORMER PRAMET



CONEXIÓN PERMANENTE

¿Sin wifi o sin conexión a Internet? La Calculadora de Mecanizado trabaja perfectamente incluso cuando usted está desconectado, asegurándole que siempre está disponible cuando la necesita. **Símplemente Fiables.**

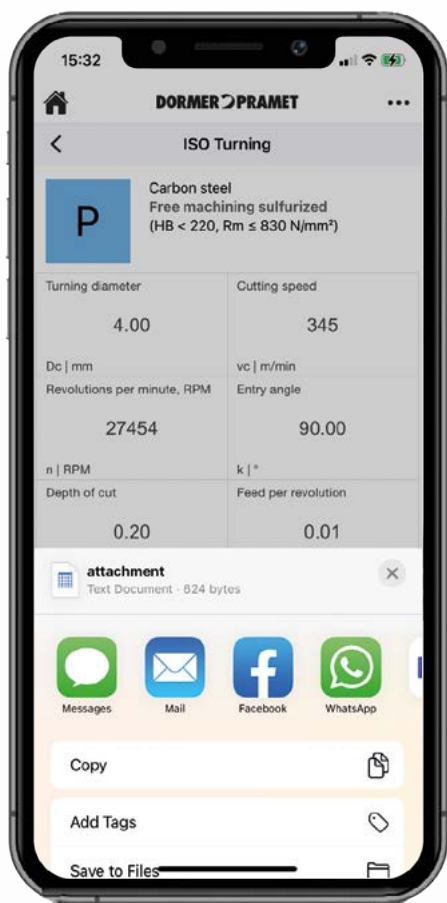



**MANDRINADO
INFORMACIÓN TÉCNICA**



GRUPOS DE MATERIALES (WMG)

ISO Para seleccionar una calidad y geometría de corte para una amplia gama de materiales a mecanizar

Definición general

P. ej., acero, acero inoxidable, etc.

P **M** **K** **N** **S** **H**

Subgrupo

Para navegar y seleccionar la herramienta idónea para una gama más específica de materiales a mecanizar

Definición por estructura/composición

P. ej., acero al carbono, acero aleado, etc.

P **M** **K** **N** **S** **H**

P1

P2

P3

P4

WMG

Para seleccionar y proporcionar condiciones de corte dentro de un rango de $\pm 10\%$

Definición por dureza/resistencia a la tracción

P. ej., $160 < 220$ HB, $620 < 900$ N/mm² ...

P

P1 **P1.1** **P1.2** **P1.3**

P2 **P2.1** **P2.2** **P2.3**

P3 **P3.1** **P3.2** **P3.3**

P4 **P4.1** **P4.2** **P4.3**

SOBRE LA CLASIFICACIÓN DE MATERIALES EN DORMER PRAMET

Los grupos de materiales («WMG») se utilizan para seleccionar de forma sencilla y fiable la herramienta de corte adecuada y los valores iniciales apropiados para las condiciones de mecanizado de aplicaciones específicas.

Dormer Pramet clasifica los materiales a mecanizar en seis grupos de diferentes colores:

- **Azul:** acero y acero fundido (grupo P);
- **Amarillo:** acero inoxidable (grupo M);
- **Rojo:** fundición (grupo K);
- **Verde:** materiales no férricos (grupo N);
- **Marrón:** aleaciones termoresistentes (grupo S);
- **Gris:** materiales endurecidos (grupo H).

Cada uno de estos grupos se divide, a su vez, en subgrupos según su estructura o composición. Por ejemplo, el grupo P de acero y acero fundido se desglosa en cuatro subgrupos:

- **P1 – Acero de fácil mecanizado**
- **P2 – Acero al carbono**
- **P3 – Acero aleado**
- **P4 – Acero para herramientas**

Finalmente, se realiza una última división en función de las propiedades del material, como la dureza y la resistencia a la tracción. Esta clasificación se lleva a cabo para ofrecer a nuestros clientes un asesoramiento completo sobre la herramienta y los valores iniciales de velocidad de corte y avance.

La tabla que se muestra en la página siguiente incluye una descripción de cada grupo de materiales a mecanizar, así como ejemplos de designaciones de uso común.



GRUPOS DE MATERIALES (WMG)

Grupo ISO	Subgrupo	WMG (Work Material Group/grupo de material de la pieza)	k_{wg}	Ejemplos de material (AISI, EN, DIN, ČSN, GB, SS, STN, BS, UNE, AFNOR, ASTM, GOST, UNS, UNI, etc.)
P Acero y acero fundido (aceros con un contenido de aleación ≤10% y una dureza <45 HRC)	P1 Acero de fácil mecanizado (aceros al carbono con maquinabilidad aumentada)	P1.1 Acero al carbono sulfurado de mecanizado libre con una dureza <240 HB	1.33	AISI 1108, EN 1552, DIN 1.0723, SS 1922, ČSN 11120, BS 210A15, UNE F.210F, GB Y15, AFNOR 10F1, GOST A30, UNI CF10S20
		P1.2 Acero al carbono sulfurado y fosforizado de mecanizado libre con una dureza <180 HB	1.49	AISI 1211, EN 115Mn30, DIN 1.0715, SS 1912, ČSN 11109, BS 230M7, UNE F.2111, GB Y15, AFNOR S250, GOST A40G, UNI CF9SMn28
		P1.3 Acero al carbono sulfurado/fosforizado y con plomo de mecanizado libre con una dureza <180 HB	1.53	AISI 12L13, EN 115MnPb30, DIN 1.0718, SS 1914, ČSN 12110, BS 210M16, UNE F.2114, GB Y15Pb, AFNOR S250Pb, GOST AS35G2, UNI CF10SPb20
	P2 Acero al carbono (aceros compuestos principalmente por hierro y carbono)	P2.1 Acero de bajo contenido en carbono con <0,25% C y una dureza <180 HB	1.14	AISI 1015, EN C15, DIN 1.0401, SS 1350, ČSN 11301, BS 080A15, UNE F.111, GB 15, AFNOR C18RR, GOST S22ps, UNI Fe360
		P2.2 Acero con contenido medio de carbono <0,55% C y una dureza <240 HB	1.00	AISI 1030, EN C30, DIN 1.0528, SS 1550, ČSN 12031, BS 080M32, UNE F.1130, GB 30, AFNOR AF50C30, GOST 30G, UNI Fe590
		P2.3 Acero de alto contenido en carbono con >0,55% C y una dureza de <300 HB	0.89	AISI 1060, EN C60, DIN 1.0601, SS 1655, ČSN 12061, BS 080A62, UNE F.513, GB 60, AFNOR 1C60, GOST 60G, UNI C60
	P3 Acero aleado (aceros al carbono con un contenido de aleación ≤10%)	P3.1 Acero aleado con una dureza <180 HB	0.92	AISI 5015, EN 16Mo3, DIN 1.5415, SS 2912, ČSN 15020, BS 1501-240, UNE F.2601, GB 16Mo, AFNOR 15D3, GOST 15M, UNI 16Mo3KW
		P3.2 Acero aleado con una dureza de 180-260 HB	0.74	AISI 4140, EN 42CrMo4, DIN 1.7225, SS 2244, ČSN 15142, BS 708M40, UNE F.8232, GB 42CrMo, AFNOR 42CD4, GOST 40CHFA, UNI 42CrMo4
		P3.3 Acero aleado con una dureza de 260-360 HB	0.63	AISI 4140, EN 42CrMo4, DIN 1.7225, SS 2244, ČSN 15142, BS 708M40, UNE F.8232, GB 42CrMo, AFNOR 42CD4, GOST 40CHFA, UNI 42CrMo4
	P4 Acero para herramientas (acero de aleación especial para herramientas, matrices y moldes)	P4.1 Acero para herramientas con una dureza <26 HRC	0.55	AISI D2, EN X155CrVMo12-1, DIN 1.2370, SS 2736, ČSN 19573, BS BD2, UNE F.520A, GB Cr12Mo1V1, AFNOR Z160CDV12, GOST Ch12MF, UNI X155CrVMo121KU
		P4.2 Acero para herramientas con una dureza de 26-39 HRC	0.47	AISI D2, EN X155CrVMo12-1, DIN 1.2370, SS 2736, ČSN 19573, BS BD2, UNE F.520A, GB Cr12Mo1V1, AFNOR Z160CDV12, GOST Ch12MF, UNI X155CrVMo121KU
		P4.3 Acero para herramientas con una dureza de 39-45 HRC	0.38	AISI D2, EN X155CrVMo12-1, DIN 1.2370, SS 2736, ČSN 19573, BS BD2, UNE F.520A, GB Cr12Mo1V1, AFNOR Z160CDV12, GOST Ch12MF, UNI X155CrVMo121KU



GRUPOS DE MATERIALES (WMG)

Grupo ISO	Subgrupo	WMG (Work Material Group/grupo de material de la pieza)	k _{vg}	Ejemplos de material (AISI, EN, DIN, ČSN, GB, SS, STN, BS, UNE, AFNOR, ASTM, GOST, UNS, UNI, etc.)
M Acero inoxidable (aceros resistentes a la corrosión con un contenido de cromo ≥11 %)	M1 Acero inoxidable ferrítico (aleaciones rectas de cromo no endurecibles)	M1.1 Acero inoxidable ferrítico con una dureza <160 HB	1.22	AISI 5429, EN X7Cr14, DIN 1.4001, SS 2326, BS 434517, UNE F.3401, AFNOR Z8C12, GOST 08Ch13, UNI X6CrTi12
		M1.2 Acero inoxidable ferrítico con una dureza de 160-220 HB	1.03	AISI 446, EN X10CrAl24, DIN 1.4762, SS 2322, ČSN 17113, BS 430517, UNE F.3154, GB 10Cr17, AFNOR Z10CA524, GOST 12Ch17, UNI X16Cr26
	M2 Acero inoxidable martensítico (aleaciones rectas de cromo no endurecibles)	M2.1 Acero inoxidable martensítico con una dureza <200 HB	1.08	AISI 430F, EN X14CrMo517, DIN 1.4104, SS 2383, ČSN 17140, BS 410521, UNE F.3117, AFNOR Z10CF17, UNI X10Cr517
		M2.2 Acero inoxidable martensítico con una dureza de 200-280 HB	0.89	AISI 440C, EN X105CrMo17, DIN 1.4125, SS 2385, ČSN 17023, BS 425C11, UNE F.3402, GB 102Cr17Mo, AFNOR Z100CD17, GOST 95Ch18, UNI GX6CrNi 13 04
		M2.3 Acero inoxidable martensítico con una dureza de 280-380 HB	0.75	AISI 420, EN X45Cr13, DIN 1.4034, ČSN 17029, BS 425C11, UNE F.3405, AFNOR Z44C14, GOST 20X17H12, UNI X30Cr13
	M3 Acero inoxidable austenítico (aleaciones de cromo-níquel y cromo-níquel-manganeso)	M3.1 Acero inoxidable austenítico con una dureza <200 HB	1.00	AISI 304, EN X5CrNi18-12, DIN 1.4303, SS 2352, ČSN 17249, BS 305517, UNE F.3513, GB 10Cr18Ni12, AFNOR Z8CN18.12, UNI X7CrNi18 10
		M3.2 Acero inoxidable austenítico con una dureza de 280-260 HB	0.86	AISI 309, EN X15CrNiSi20-12, DIN 1.4828, ČSN 17251, BS 309S24, UNE F.3312, GB 1G23Ni13, AFNOR Z15CNS20.12, GOST 20Ch20Ni452, UNI 16CrNi23 14
		M3.3 Acero inoxidable austenítico con una dureza de 260-300 HB	0.77	AISI 5848, EN X45CrNiW18-9, DIN 1.4873, BS 331540, UNE F.3211, AFNOR Z35CNW514-4, UNI X45CrNiW 18 9
	M4 Acero inoxidable superaustenítico, duplex o templado por precipitación (aleaciones austeníticas con > 20 % Ni, microestructura austenítica-ferrítica o templado por precipitación)	M4.1 Acero inoxidable superaustenítico/ferrítico o superaustenítico con una dureza <300 HB	0.75	AISI 329, EN X1-NiCrMoCu25-20-5, DIN 1.4539, SS 2562, ČSN 17265, BS 318513, UNE F.3552, GB 022Cr25NiMo2N, AFNOR Z1NCUD25.20
		M4.2 Acero inoxidable austenítico, templado por precipitación y una dureza de 300-380 HB	0.64	AISI 631 (17-7PH), EN X7CrNiAl17-7, DIN 1.4568, SS 2388, ČSN 17465, BS 301513, UNE F.3217, GB 07Cr17Ni7Al, AFNOR Z9CNA17-07, GOST 09Ch17N7Jut, UNI X53CrMnNiN21 9



GRUPOS DE MATERIALES (WMG)

Grupo ISO	Subgrupo	WMG (Work Material Group/grupo de material de la pieza)	k_{wc}	Ejemplos de material (AISI, EN, DIN, ČSN, GB, SS, STN, BS, UNE, AFNOR, ASTM, GOST, UNS, UNI, etc.)
K Fundición (piezas de fundición y aleaciones al carbono con un contenido de carbono >2 %)	K1 Fundición gris (GG) (fundiciones de hierro y carbono con microestructura de grafito laminar)	K1.1 Fundición gris ferrítica o ferrítica/perlítica con una dureza <180 HB	1.35	ASTM A48 Grade 20 (F11401), EN-JL-100, DIN GG-10 (0.6010), SS 0110, STN 422410, BS Grade 150, UNE FG10, GB HAT 100, AFNOR Fc10D, GOST SC 10, UNI G10
		K1.2 Fundición gris ferrítica/perlítica o perlítica con una dureza de 180-240 HB	1.00	ASTM A48 Grade 30 (F12101), EN-JL-1030, DIN GG-20 (0.6020), SS 0120, STN 422420, BS Grade 220, UNE FG20, GB HT200, AFNOR Ft20D, GOST Ч420, UNI G20
		K1.3 Fundición gris perlítica con una dureza de 240-280 HB	0.75	ASTM A48 Grade 50 (F13501), EN-JL-1060, DIN GG-35 (0.6035), SS 0135, STN 422435, BS Grade 350, UNE FG35, GB HAT300, AFNOR Fc35D, GOST SC35, UNI G35
	K2 Fundición maleable (GTS/GTW) (fundiciones de hierro y carbono tratadas térmicamente con una microestructura sin grafito)	K2.1 Fundición maleable ferrítica con una dureza <160 HB	1.39	ASTM A602 Grade M3210 (F20000), EN-JM-1130, DIN GTS-35 (0.8135), SS 0815, BS B340/12, UNE Type A, AFNOR MN 35-10, GOST K435-10
		K2.2 Fundición maleable, ferrítica o perlítica, con una dureza de 160-200 HB	1.13	ASTM A602 Grade M4504 (F20001), EN-JM-1040, DIN GTS-50-05 (0.8045), BS P50-05, AFNOR MB 45-7
		K2.3 Fundición maleable perlítica con una dureza de 200-240 HB	0.90	ASTM A602 Grade M7002 (F20004), EN-JM-1140, DIN GTS-45 (0.8145), SS 0854, STN 422540, BS P 45-06, UNE Typ B, AFNOR MP 50-5, GOST K445-7, UNI GMM 45
	K3 Fundición dúctil (GGG) (fundiciones de hierro y carbono con microestructura de grafito nodular)	K3.1 Fundición dúctil (nodular/esferoidal) ferrítica con una dureza <180 HB	1.23	ASTM A536 Grade 60-40-18 (F32800), EN-JS-1030, DIN GGG-40 (0.7040), SS 0717, STN 422304, BS 420/12, UNE FGE 42-12, GB QT 400, AFNOR FGS 400-12, GOST B440
		K3.2 Fundición dúctil (nodular/esferoidal), ferrítica o perlítica, con una dureza de 180-220 HB	0.94	ASTM A536 Grade 80-55-06 (F33800), EN-JS-1050, DIN GGG-50 (0.7050), SS 0727, STN 422305, BS 500/7, UNE FGE 50-7, GB QT 500-7, AFNOR FGS 500-7, GOST B450
		K3.3 Fundición dúctil (nodular/esferoidal) perlítica con una dureza de 220-260 HB	0.76	ASTM A536 Grade 100-70-03 (F34800), EN-JS-1060, DIN GGG-60 (0.7060), SS 0732, STN 422306, BS 600/3, UNE FG70-2, GB QT 600-3, AFNOR FGS 600-3, GOST B460
	K4 Fundición dúctil austenítica o austemperada (Ni-Resist/ADI) (fundiciones de aleaciones de hierro y carbono con una microestructura austenítica o ausferrita)	K4.1 Fundición austenítica con una dureza <180 HB	1.14	ASTM A436 Type 1 (L-NiCuCr 15 6 2, F41000), EN-JL-3011, DIN GGL-NiMn 13 7 (0.6652), SS 0523, BS Grade F1, AFNOR FGL-Ni13Mn7, GOST ЧН19Х3U
		K4.2 Fundición austenítica con una dureza de 180-240 HB	0.86	ASTM A439 Type D-2B (S-NiCr 20 3, F43001), EN-JS-3021, DIN GGG-NiMn 23 4, SS 0776, BS Grade S2M, AFNOR FGS Ni23 Mn4, GOST ЧН19Х3U
		K4.3 Fundición dúctil austemperada con una dureza de 240-280 HB	0.63	ASTM A897 Grade 110-70-11
	K5 Fundición de grafito compactado (CGI) (fundiciones de hierro y carbono con estructura de grafito vermicular)	K4.4 Fundición dúctil austemperada con una dureza de 280-320 HB	0.54	ASTM A897 Grade 125-80-10, EN-JS-1100, DIN GGG-90 (5.3400)
		K4.5 Fundición dúctil austemperada con una dureza de 320-360 HB	0.45	ASTM A897 Grade 2 (150-110-07), EN-JS-1110, DIN GGG-100 (5.3403)
		K5.1 Fundición de grafito compactado vermicular con una dureza <180 HB	1.29	ASTM A842 Grade 300, EN-GJV-300, DIN GGV 30, GOST ЧВТ30,
K5 Fundición de grafito compactado (CGI) (fundiciones de hierro y carbono con estructura de grafito vermicular)	K5.2 Fundición de grafito compactado vermicular con una dureza de 180-220 HB	0.97	ASTM A842 Grade 350, EN-GJV-350, DIN GGV 35 (5.2200), GOST ЧВТ30,	
	K5.3 Fundición de grafito compactado vermicular con una dureza de 220-260 HB	0.75	ASTM A842 Grade 450, EN-GJV-450, DIN GGV 45, GOST ЧВТ45,	



GRUPOS DE MATERIALES (WMG)

Grupo ISO	Subgrupo	WMG (Work Material Group/grupo de material de la pieza)	k _{vg}	Ejemplos de material (AISI, EN, DIN, ČSN, GB, SS, STN, BS, UNE, AFNOR, ASTM, GOST, UNS, UNI, etc.)
N Materiales no ferreos (metales, incluidas las aleaciones sin una cantidad apreciable de hierro y otros materiales no metálicos)	N1 Aluminio forjado	N1.1 Aluminio puro y aleaciones forjadas de aluminio con una dureza <60 HB	1.33	UNS A91200, EN AL99.6, DIN 3.0205, SS 4010, STN 424009, BS 1C, UNE L-3001, GB L5, AFNOR A4, GOST A1C, UNI 3567
		N1.2 Aleaciones forjadas de aluminio con una dureza de 60-100 HB	1.00	UNS A93004, EN AIMn0.5Mg0.5, DIN 3.0505, SS 4054, STN 424432, BS N31, UNE L-3831, GB LF2, AFNOR A-M1, GOST AM14, UNI 3568
		N1.3 Aleaciones forjadas de aluminio con una dureza de 100-150 HB	0.67	UNS A95083, EN AIMg4.5Mn0.7, DIN 3.3547, SS 4140, STN 424415, BS N8, UNE L-3321, GB AIMg4.5Mn, AFNOR A-G4.5Mn, GOST Amg 4.5, UNI P-AIMg4.4
	N2 Aluminio fundido	N2.1 Aleaciones de aluminio fundido con una dureza <75 HB	0.67	UNS A02080, EN AICu45, BS LM11, STN 424331, UNE AISi1Cu, GOST AMg5K, UNI G-AISi7Mg
		N2.2 Aleaciones de aluminio fundido con una dureza de 75-90 HB	0.60	UNS A02420, EN AICu4Ni2Mg2, SS AISi7MgFe, BS LM6, STN 424519, UNE AI-7SiMg, AFNOR A-S7G, GOST AK7, UNI G-AISi7Mg
		N2.3 Aleaciones de aluminio fundido con una dureza de 90 < 140 HB	0.43	UNS A03360, EN G-ALCu4NiMg2, SS ALSi10Mg, STN 424336, BS LM 30, AFNOR A-S10G, UNI G-AISi9Mg
	N3 Cobre o aleaciones de cobre	N3.1 Aleaciones de cobre con excelentes propiedades de mecanizado	0.70	UNS C14700, EN CuPb1P, DIN 2.1498, STN 423214, BS C111, AFNOR CuZn35Pb2, GOST L63-3, UNI CuS(P0.01)
		N3.2 Aleaciones de cobre de viruta corta con propiedades de mecanizado de óptimas a moderadas	0.41	UNS C81540, EN CuNi25iCr, DIN 2.0857, STN 423220, BS NS113, UNE CuSn12, AFNOR CuZn40, GOST L60, UNI P-CuZn-40
		N3.3 Cobre electrolítico y aleaciones de cobre de viruta larga con propiedades de mecanizado de moderadas a limitadas	0.21	UNS C10100, EN CuAg0.1, DIN 2.1203, SS 5010, UNE CUSi3Mn1, AFNOR Cu-C2, GOST M1f, UNI Cu-0F
	N4 Polímeros (materiales sintéticos o semisintéticos)	N4.1 Polímeros termoplásticos	0.70	ABS, Acryl, Duraplast, Elastomer, EP, Epoxid, FEP, Fluor, Gummi, Kautschuk, Latex, ME, MPF, PA, PAI, PC, PE, PEEK, PEI, PES, PET, PF, Phenolharze, PI, PMMA, Polyamide, Polyester, Polyolefine, Polysulfon, POM, PP, PPE, PPS, PS, PSU, PTFE, PU, PUR, PVDF, SAN, SI, Styrol, UF, Ureol
		N4.2 Polímeros termoestables	0.27	Aramid, Epoxy, Fluoropolymer, Mehtacrylate, Melamine, Phenolic, Polyester, Polyimide, Polymethacrylimide, Polyurethane
		N4.3 Composites o polímeros reforzados	0.29	CFK, GFK, GMT, Honeycomb, Kevlar, LFT, Organo, SMC
	N5 Grafito	N5.1	1.0	CGM-1, CM-00, GM-10, GM-11, GR030, GR030PI, GR060, GR060PI, GR125, MC-01, MC-01R0, MC-03, MC-03M, IG11, IG-15, IG-32, IG-43, IG-45, IG-70, ISEM-1, ISEM-2, ISEM-3, R8340, R8500X, Technograph 15, Technograph 30, ISO-63, EDM C-3, EDM1, EDM3, ISO-90, ISO-93, ISO-95, R8510, R8650, R8650



GRUPOS DE MATERIALES (WMG)

Grupo ISO	Subgrupo	WMG (Work Material Group/grupo de material de la pieza)	$k_{w,c}$	Ejemplos de material (AISI, EN, DIN, ČSN, GB, SS, STN, BS, UNE, AFNOR, ASTM, GOST, UNS, UNI, etc.)
S Aleaciones termorresistentes (superalaciones con una alta resistencia a la temperatura y a la corrosión, superior a la del acero inoxidable)	S1 Titanio o aleaciones de titanio	S1.1 Titanio o aleaciones de titanio con una dureza <200 HB	1.94	UNS R50250 (Grade 1), EN Ti 99.6, DIN 3.7035, BS TA.2, UNE Ti-Po2, AFNOR T-40, GOST BT1-00, AISI R50250, 3.7025, T35, 2TA1, R50400, 3.7035, 2TAZ,
		S1.2 Aleaciones de titanio con una dureza de 200-280 HB	1.72	UNS R56404 (Grade 29), EN Ti2Cu, DIN 3.7124, BS TA.21, UNE Ti-P11, AFNOR T-U2, AISI TA6V, Ti-6Al-4V, Ti 10.2.3, Ti5553
		S1.3 Aleaciones de titanio con una dureza de 280-360 HB	1.44	UNS R54250 (Grade 38), EN TiAl6V4, DIN 3.7165, ČSN TiAl6VELI, BS TA. 13, UNE Ti-P63, AFNOR T-A6V, GOST BT6, AISI TA6V, Ti-6Al-4V, Ti 10.2.3, Ti5553
	S2 Aleaciones termorresistentes con base Fe	S2.1 Aleaciones termorresistentes con base Fe con una dureza <200 HB	1.33	UNS N08801 (Incoloy 801), EN X8 NiCrAlTi31-21, DIN 1.4959, BS NA 15, AFNOR Z8NC33-21, AISI A-286, Discaloy, Haynes 556, Inconel 909, Greek Ascology
		S2.2 Aleaciones termorresistentes con base Fe con una dureza de 200-280 HB	1.17	UNS N19907, EN X6NiCrTiMoVB25-15-2, DIN 1.4980, SS 2570, BS HR52, AFNOR Z6NCTDV25.15B, GOST 36HXT10, AISI A-286, Discaloy, Haynes 556, Inconel 909, Greek Ascology
	S3 Aleaciones termorresistentes con base Ni	S3.1 Aleaciones termorresistentes con base Ni con una dureza <280 HB	1.00	UNS A09706 (Inconel 706), EN NiCr25FeAl, DIN 2.4856, BS HR 6, ČSN Inconel 625, UNE F.3313, GB 1Cr16Ni35, AFNOR NC22FeDNB, GOST XH38BT, AISI Inconel 718, 706 Waspalloy, Udimet 720, Inconel 625
		S3.2 Aleaciones termorresistentes con base Ni con una dureza de 280-360 HB	0.83	UNS N07001, EN NiCr20Co13Mo4Ti3Al, DIN 2.4654, BS HR 2, ČSN Waspalloy, AFNOR NCKD 20ATV, GOST XH80T5K0, AISI Inconel 718, 706 Waspalloy, Udimet 720, Inconel 625
	S4 Aleaciones termorresistentes con base Co	S4.1 Aleaciones termorresistentes con base Co con una dureza <240 HB	0.78	UNS R30016 (Stellite 6b), EN CoCr20W15Ni, DIN 2.4964, AFNOR KC 20 WN, GOST ЛК52, AISI Haynes 25, Stellite 21, 31
		S4.2 Aleaciones termorresistentes con base Co con una dureza de 240-320 HB	0.67	UNS R30016 (Stellite 6b), EN CoCr20W15Ni, DIN 2.4964, AFNOR KC 20 WN, GOST ЛК52, AISI Haynes 25, Stellite 21, 31







GRUPOS DE MATERIALES (WMG)

Grupo ISO	Subgrupo	WMG (Work Material Group/grupo de material de la pieza)	k_{vg}	Ejemplos de material (AISI, EN, DIN, ČSN, GB, SS, STN, BS, UNE, AFNOR, ASTM, GOST, UNS, UNI, etc.)
H Materiales endurecidos (cualquier metal técnico con una dureza >45 HRC)	H1	Fundición en frío		
	H1.1	Fundición en frío con una dureza <440 HB	1.52	UNS F45001, EN-GJS-1050-6, DIN 5.3406, SS 0512, BS Grade 2A
	H2	Fundición endurecida		
	H2.1	Fundición endurecida con una dureza <55 HRC	0.90	UNS F45003, EN-GJS-1400-1, DIN 5.3405, SS 0457, BS Grade 3D
	H2.2	Fundición endurecida con una dureza >55 HRC	0.77	UNS F45003, EN G-X260NiCr4-2, DIN 0.9620, SS 0466, BS Grade S
	H3	Acero endurecido <55 HRC		
	H3.1	Acero endurecido con una dureza <51 HRC	1.00	AISI 4135, EN 34CrMo4, DIN 1.7220, SS 2234, STN 415131, BS 198, UNE F.1250, GB 35CrMo, AFNOR 35CD4, GOST AC38XTM, UNI 35CrMo4KB
	H3.2	Acero endurecido con una dureza de 51-55 HRC	0.82	AISI 4135, EN 34CrMo4, DIN 1.7220, SS 2234, STN 415131, BS 198, UNE F.1250, GB 35CrMo, AFNOR 35CD4, GOST AC38XTM, UNI 35CrMo4KB
H4	Acero endurecido >55 HRC			
H4.1	Acero endurecido con una dureza de 55-59 HRC	0.64	UNS T31501, EN 100MnCrW4, DIN 1.2510, SS 2140, STN 419413, BS B01, UNE F.5220, GB 9CrWMn, AFNOR 90MnWCrV5, GOST 9XBТ, UNI 95MnWCr5KU	
H4.2	Acero endurecido con una dureza >59 HRC	0.54	UNS T31501, EN 100MnCrW4, DIN 1.2510, SS 2140, STN 419413, BS B01, UNE F.5220, GB 9CrWMn, AFNOR 90MnWCrV5, GOST 9XBТ, UNI 95MnWCr5KU	

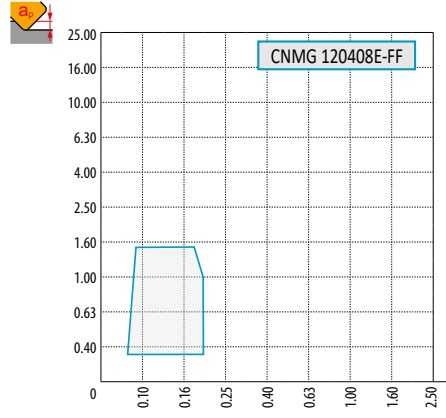
GEOMETRÍA DE PLAQUITAS NEGATIVAS: FIJACIÓN ISO P, M, D



FF

P	M	K	N	S	H
■	■	▣	■	■	■
f	0.06 – 0.25				
a_p	0.2 – 1.6				
					
					
 CNMG, DNMG, TNMG, VNMG, WNMG					

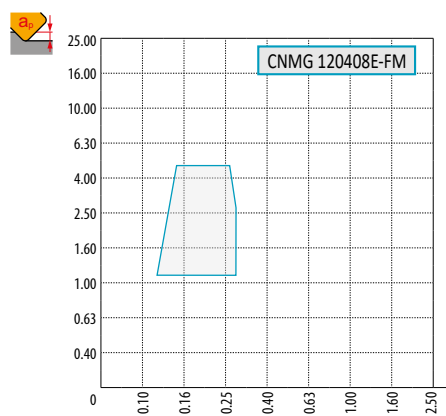

FM

P	M	K	N	S	H
■	▣	■	■	▣	■
f	0.1 – 0.5				
a_p	0.4 – 5.0				
					
					
 CNMG, DNMG, SNMG, TNMG, VNMG, WNMG					

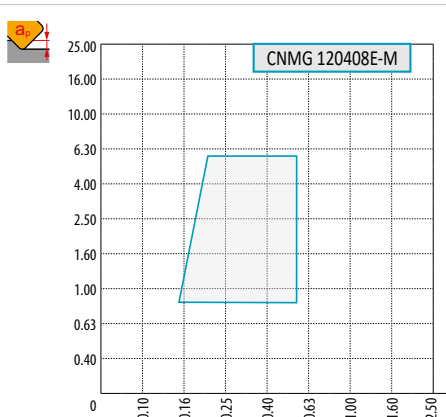

M

P	M	K	N	S	H
■	■	■	■	■	▣
f	0.17 – 0.80				
a_p	0.8 – 8.0				
					
					
 CNMG, DNMG, SNMG, TNMG, VNMG, WNMG					

NF

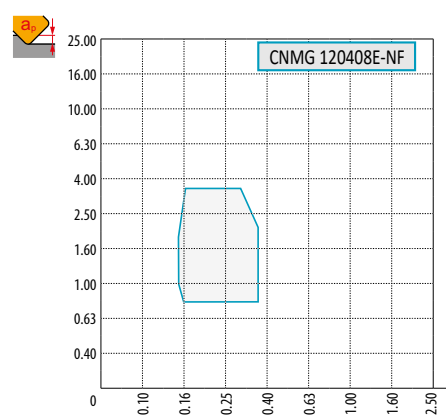



P	M	K	N	S	H
■	■	▣	▣	▣	■
f	0.1 – 0.35				
a_p	0.4 – 4.0				
					
					
 CNMG, DNMG, SNMG, TNMG, VNMG, WNMG					

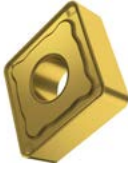
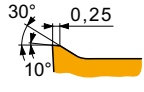
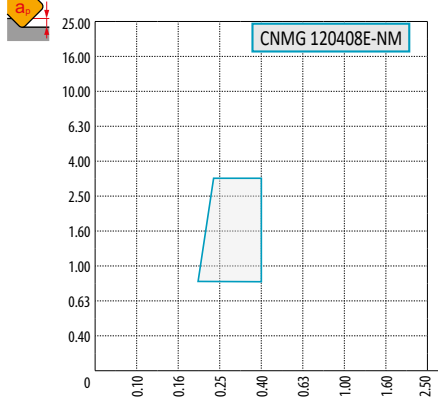

GEOMETRÍA DE PLAQUITAS NEGATIVAS: FIJACIÓN ISO P, M, D

NM





P	M	K	N	S	H
■	■	■	☑	■	
f → 0.15 – 0.55					
a _p ↓ 0.5 – 8.0					

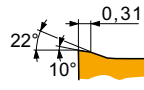
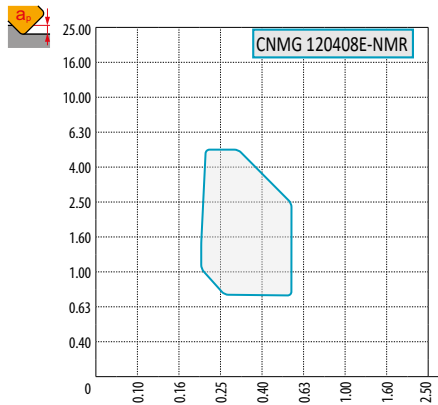

? CNMG, DNMG, TNMG, VNMG, WNMG

NMR





P	M	K	N	S	H
■	■	■	☑	■	
f → 0.18 – 0.70					
a _p ↓ 0.4 – 8.0					

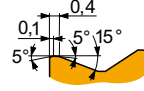
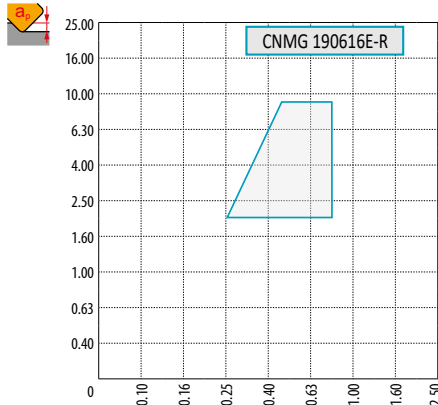

? CNMG, DNMG, SNMG, TNMG, VNMG, WNMG

R





P	M	K	N	S	H
■	■	■	☑	■	■
f → 0.25 – 0.80					
a _p ↓ 2.0 – 9.0					

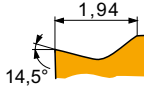
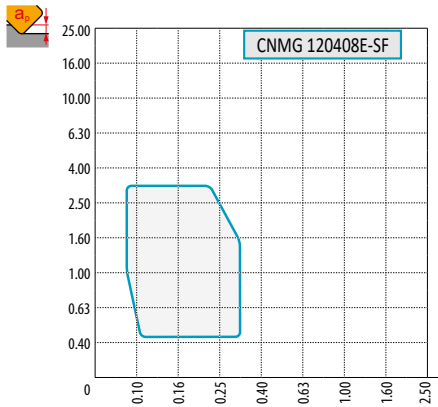

? CNMG, DNMG, SNMG, TNMG, WNMG

SF

P	M	K	N	S	H
■	■	■	☑	■	■
f → 0.08 – 0.35					
a _p ↓ 0.2 – 3.5					



? CNGG, CNMG, DNMG, SNMG, TNMG, VNMG, WNMG

GEOMETRÍA DE PLAQUITAS NEGATIVAS: FIJACIÓN ISO P, M, D

SI

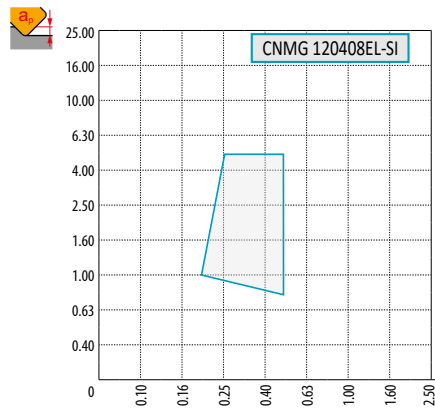
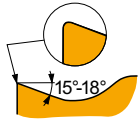

P	M	K	N	S	H
■	■	■	▣	▣	
f	0.20 – 0.50				
a_p	0.8 – 5.0				
?	CNMG, DNMG, TNMG, WNMG				

SM

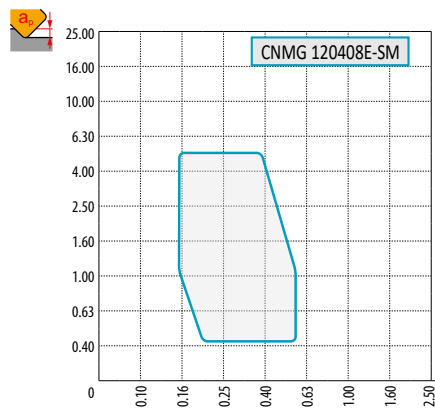
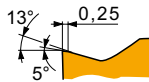
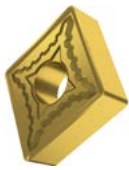



P	M	K	N	S	H
■	■	■	▣	■	▣
f	0.15 – 0.55				
a_p	0.4 – 6.0				
?	CNMG, DNMG, SNMG, TNMG, VNMG, WNMG				

GEOMETRÍA DE PLAQUITAS POSITIVAS: FIJACIÓN ISO S

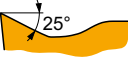
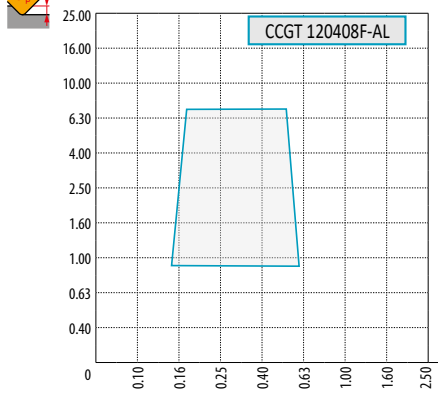

AL

P	M	K	N	S	H
			■	▣	
f	0.05 – 0.60				
a_p	0.2 – 7.0				
					
					
 CCMT, DCMT, SCMT, TCMT, VBMT, WCMT					

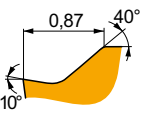
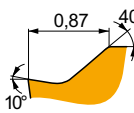

FF

P	M	K	N	S	H
■	▣				
f	0.05 – 0.23				
a_p	0.2 – 2.0				
					
					
 CCMT, DCMT					

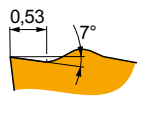
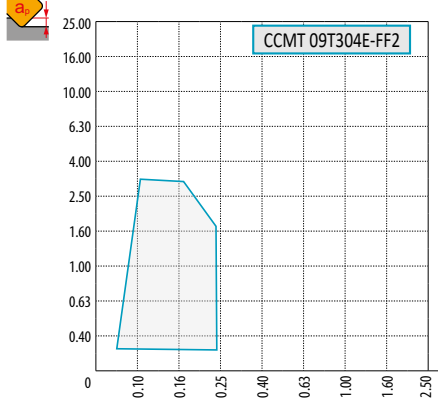

FF2

P	M	K	N	S	H
■		■			
f	0.02 – 0.28				
a_p	0.20 – 3.0				
					
					
 CCMT, CCMT, DCMT, DCMT, SCMT, TCMT, TCMT, VBMT, VCGT, VCGX, WCGT					

FM

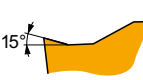
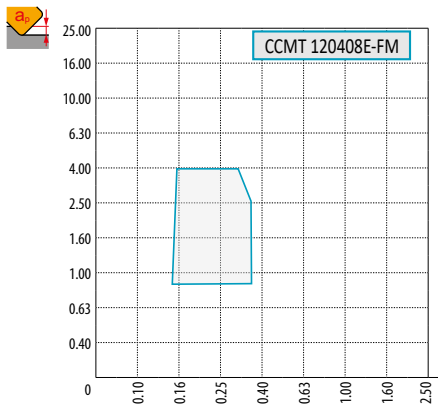



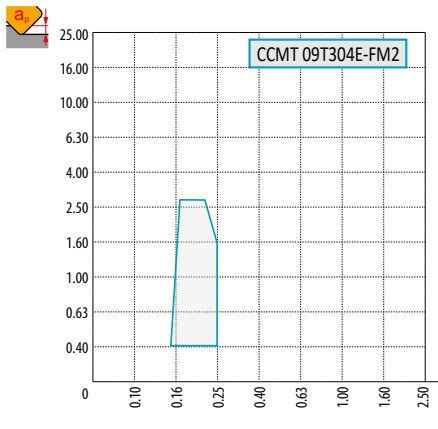

P	M	K	N	S	H
■	■	▣	▣		
f	0.05 – 0.45				
a_p	0.2 – 4.0				
					
					
 CCMT, DCMT, SCMT, TCMT, VBMT, WCMT					

GEOMETRÍA DE PLAQUITAS POSITIVAS: FIJACIÓN ISO S



FM2

P	M	K	N	S	H
■	▣	■	■	■	■
f	0.04 – 0.4				
a_p	0.2 – 4.0				
					
					
?	CCMT, DCMT, ECMT, SCMT, TCMT, VBMT, VCGT				

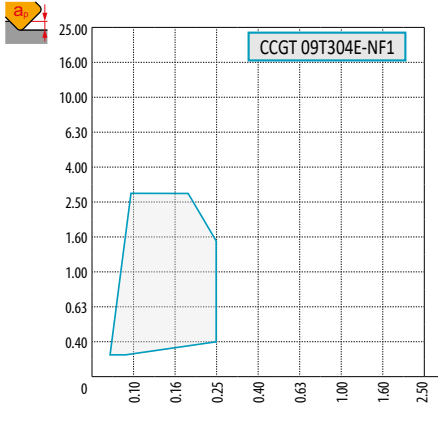

NF1

P	M	K	N	S	H
■	■	■	▣	■	▣
f	0.04 – 0.35				
a_p	0.3 – 3.5				
					
					
?	CCGT, DCGT, SCGT, TCGT				

NF2

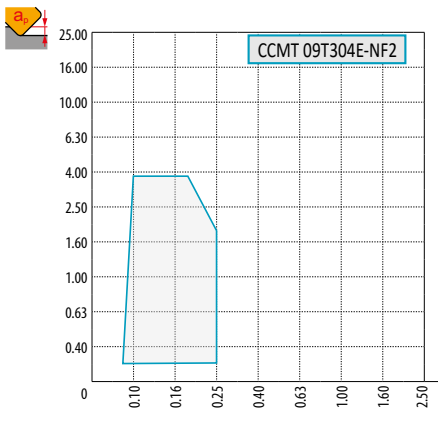



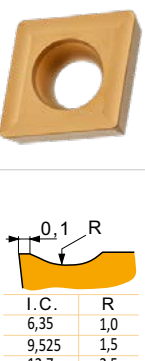

P	M	K	N	S	H
▣	■	▣	▣	■	■
f	0.05 – 0.45				
a_p	0.2 – 4.0				
					
					
?	CCMT, EPMT, SCMT, TCMT, VCGT				

RF

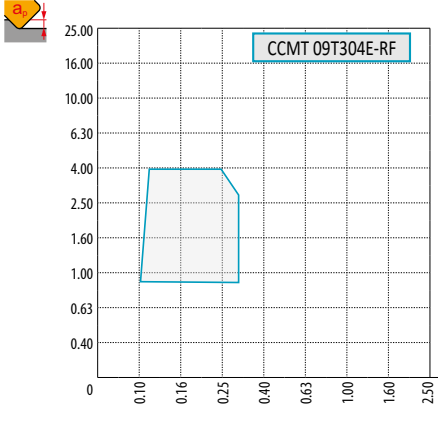

I. C.	R
6,35	1,0
9,525	1,5
12,7	2,5



P	M	K	N	S	H
■	▣	■	■	■	▣
f	0.10 – 0.60				
a_p	0.8 – 8.0				
					
					
?	CCMT, DCMT, SCMT, TCMT, WCMT				



GEOMETRÍA DE PLAQUITAS POSITIVAS: FIJACIÓN ISO S

RM

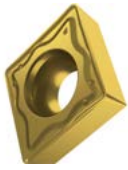
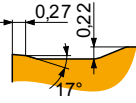
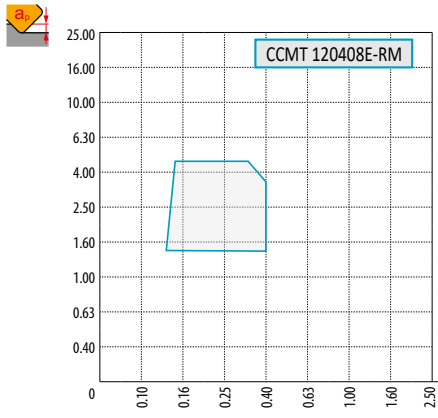



P	M	K	N	S	H
■	■	■	■	■	■
f 0.10 – 0.50					
a _p 0.8 – 4.5					

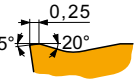
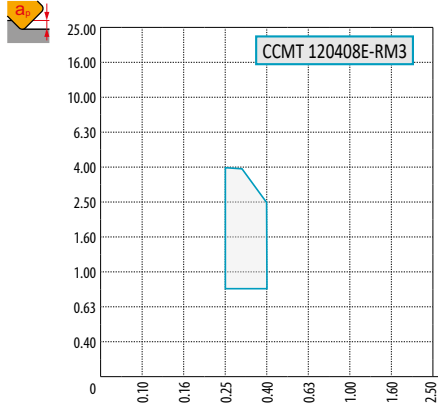

? CCMT, DCMT, SCMT, TCMT, VBMT

RM3





P	M	K	N	S	H
■	■	■	■	■	■
f 0.15 – 0.90					
a _p 0.4 – 6.00					

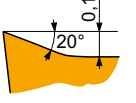
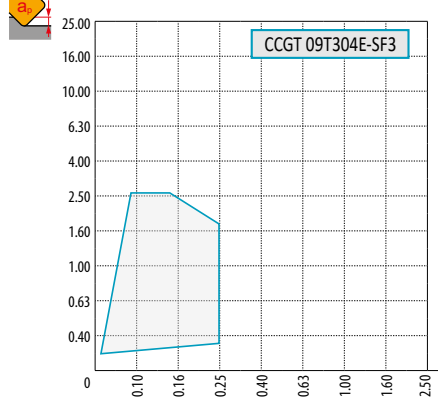

? CCMT, SCMT, TCMT, RCMT

SF3





P	M	K	N	S	H
■	■	■	■	■	■
f 0.02 – 0.35					
a _p 0.2 – 4.00					

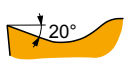
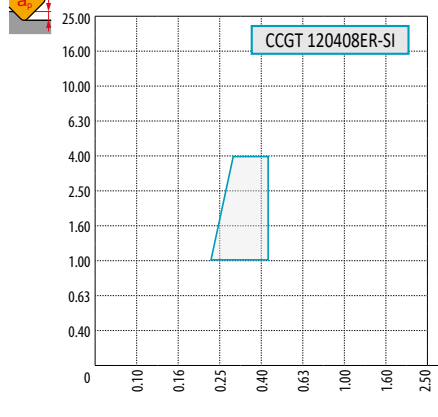

? CCGT, DCGT, ECGT, SCGT, TCGT, VCGT

SI

P	M	K	N	S	H
■	■	■	■	■	■
f 0.08 – 0.45					
a _p 0.4 – 4.0					



? CCGT, TCGT



GEOMETRÍA DE PLAQUITAS POSITIVAS: FIJACIÓN ISO S

UR

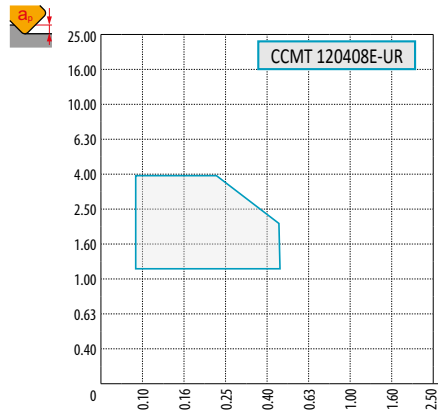
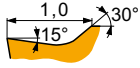

P	M	K	N	S	H
■	▣	■	■	■	■
	0.10 – 0.40				
	1.0 – 4.0				
	CCMT, DCMT, RCMT, SCMT, TCMT, VCMT, VBMT, WCMT				



CALIDADES DE MANDRINADO

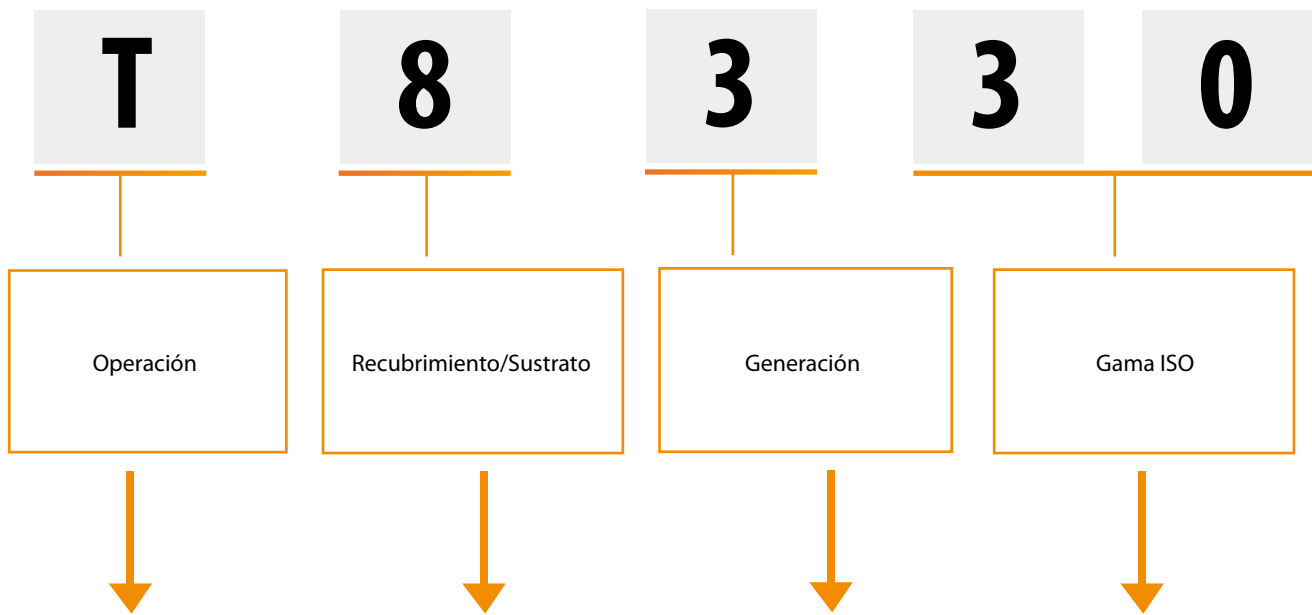

D	Taladrado
M	Fresado
T	Torneado
G	Tronzado y Ranurado

0 PVD 1 CVD	Aplicación especial
2 PVD 3 CVD	Libre
4 PVD 5 CVD	Grupos K, H
6 PVD 7 CVD	Grupos M, S
8 PVD 9 CVD	Universal
B	CBN
C	Cerámica
D	PCD
T	Cermet

1 - 9

01 - 50	
	01 - 05
	05 - 10
	10 - 20
	20 - 30
	30 - 40
	40 - 50



CALIDADES DE MANDRINADO

Identificación de la calidad	Área de aplicación	Aplicación	Avance	Velocidad de corte	Resistencia a condiciones de trabajo adversas	Recubrimiento	Color	Sustrato	Ventajas del refrigerante	Descripción de la calidad
T9315	P05 - P25	■				MT-CVD		FGM	+ +	Una calidad versátil con una excelente resistencia al desgaste, incluso con condiciones de corte intensivas. También se puede utilizar para operaciones con cortes interrumpidos. Gracias a sus propiedades bien equilibradas, esta calidad constituye la mejor opción para una amplia variedad de operaciones de torneado. No se recomienda para velocidades de corte bajas.
	K05 - K25	▣	▴	▴	▴					
	H10 - H20	▣								
T9325	P15 - P35	■				MT-CVD		FGM	+ +	Desde el punto de vista tecnológico, se trata de una calidad extremadamente versátil con una elevada resistencia a los daños mecánicos en condiciones de corte adversas y ofrece una excelente resistencia al desgaste. El uso correcto de este material requiere altas velocidades de corte.
	M10 - M30	▣	▴	▴	▴					
	K15 - K35	▣	▴	▴	▴					
	S10 - S20	▣								
T9335	P20 - P45	■				MT-CVD		FGM	+ + +	Una de las calidades más resistentes, especialmente adecuada para condiciones de corte adversas a velocidades de avance y de corte medias. En comparación con sus predecesores, M15-M40 no solo es más resistente, sino que también es más estable a la abrasión, lo que será útil cuando se utilice en condiciones de corte intensivas.
	M15 - M40	▣	▴	▴	▴					
	S15 - S25	▣								
T7325	P15 - P35	▣				MT-CVD		FGM	+ + +	Una de las calidades de torneado más universales. Es especialmente adecuada para el mecanizado de acero inoxidable. Presenta un equilibrio óptimo entre resistencia al desgaste y fiabilidad de funcionamiento. Adecuada para una amplia variedad de aplicaciones en operaciones de torneado.
	M10 - M25	▣	▴	▴	▴					
	S10 - S25	▣								
T7335	P20 - P40	▣				MT-CVD		FGM	+ + +	Calidad con un sustrato funcionalmente graduado, que se caracteriza por una fiabilidad de funcionamiento muy alta y una muy buena resistencia al desgaste. Es la más adecuada para el mecanizado de materiales muy resistentes M20-M40.
	M20 - M40	▣	▴	▴	▴					
	S15 - S25	▣								
T5305	P05 - P15	▣				MT-CVD		H	+	Calidad con una elevada resistencia al desgaste químico; es adecuada para operaciones de acabado a elevadas velocidades de corte. Gracias a su alta resistencia a la abrasión, también es adecuada para el mecanizado productivo K01-K15 de materiales endurecidos y tratados.
	K01 - K15	▣	▴	▴	▴					
	H05 - H15	▣								
T5315	P10 - P25	▣				MT-CVD		H	+	Calidad destinada principalmente al mecanizado productivo, caracterizada por una gran resistencia a la abrasión y una buena fiabilidad de funcionamiento. Debido a sus propiedades, este material es particularmente adecuado para operaciones de acabado y de desbaste con condiciones de corte buenas o ligeramente adversas.
	K10 - K25	▣	▴	▴	▴					
	H15 - H25	▣								
T0315	N05 - N20	■	▴	▴	▴	PVD			+	Calidad submicrón para el torneado de materiales no féreos y sus aleaciones con un buen equilibrio entre resistencia al desgaste y tenacidad. Cuenta con un recubrimiento único con excelentes propiedades de fricción.
T6310	P01 - P15	■				PVD		ultra submicron H	+ + +	Calidad de torneado altamente resistente al desgaste con recubrimiento superior de PVD. Resulta ideal para operaciones y aplicaciones de acabado donde es de gran importancia contar con un filo de corte afilado y una gran resistencia al desgaste en flanco.
	M01 - M15	▣	▴	▴	▴					
	K05 - K20	▣	▴	▴	▴					
	N05 - N20	▣								
	S01 - S15	▣								
	H01 - H15	▣								
T8315	P05 - P20	▣				PVD		submicron H	+ +	Calidad que presenta una excelente resistencia a la abrasión, a la vez que mantiene una fiabilidad de funcionamiento superior a la media; es adecuada para el mecanizado a velocidades de corte medias y altas en materiales duros de viruta corta.
	M05 - M20	▣	▴	▴	▴					
	K05 - K25	▣	▴	▴	▴					
	N05 - N25	▣								
	S05 - S15	▣								
	H05 - H15	▣								



CALIDADES DE MANDRINADO

Identificación de la calidad	Área de aplicación	Aplicación	Avance	Velocidad de corte	Resistencia a condiciones de trabajo adversas	Recubrimiento	Color	Sustrato	Ventajas del refrigerante	Descripción de la calidad
T8330	P25 - P40	■				PVD	■	submicron H	+++	Sin duda, el material de corte más versátil; resulta idóneo para el mecanizado de todo tipo de materiales mecanizados y es prácticamente aplicable en casi todos los tipos de operaciones de torneado. Sus principales ventajas son su elevada fiabilidad de funcionamiento y sus excelentes propiedades de fricción; por lo que es adecuado para aplicaciones a velocidades de corte medias y bajas.
	M20 - M35	■								
	K20 - K40	■								
	N15 - N30	■								
	S15 - S25	■								
	H15 - H25	■								
T8430	P20 - P40	■				PVD	■	submicron H	+++	Sin duda, el material de corte más versátil; resulta idóneo para el mecanizado de todo tipo de materiales mecanizados y es prácticamente aplicable en casi todos los tipos de operaciones de torneado. Sus principales ventajas son su elevada fiabilidad de funcionamiento y sus excelentes propiedades de fricción; por lo que es adecuado para aplicaciones a velocidades de corte medias y bajas.
	M20 - M35	■								
	K25 - K40	■								
	N15 - N30	■								
	S15 - S25	■								
	H15 - H25	■								
HF7	M10 - M20	■				×	■	submicron H	++	Calidad sin recubrimiento diseñada fundamentalmente para el mecanizado de materiales no féreos; pero también se puede utilizar para otros materiales mecanizados (excepto acero). Este material puede utilizarse en el torneado, el fresado e incluso el mandrilado.
	K10 - K25	■								
	N10 - N25	■								
H07	M05 - M15	■				×	■	submicron H	++	Calidad de torneado sin recubrimiento, adecuada para aplicaciones de mecanizado donde la resistencia a la oxidación no es el criterio determinante para la vida útil de la herramienta. Diseñada para el mecanizado de aleaciones con base de Ti. Esta calidad presenta una alta resistencia del filo de corte, junto con una buena resistencia al desgaste.
	K10 - K25	■								
	N10 - N30	■								
	S01 - S20	■								
TT310	P10 - P25	■				PVD	■	Cermet	+/-	Cermet con recubrimiento, que se utiliza para el torneado fino y de acabado de aceros al carbono y aleados (incluidos los inoxidable). Sus excelentes propiedades de fricción mejoran aún más gracias al recubrimiento aplicado mediante la técnica de PVD.
	M15 - M25	■								
TT010	P01 - P10	■				×	■	Cermet	+/-	Cermet sin recubrimiento, adecuado para el mecanizado fino de todo tipo de aceros (incluido el inoxidable) a velocidades de avance muy bajas. Su principal ventaja es el radio mínimo del filo de corte y su alta resistencia a los mecanismos de desgaste físico y químico.
	M01 - M10	■								
PD1	N05 - N25	■				×	■	PCD	--	Calidad PKD para el torneado de materiales no féreos. Es la elección ideal para trabajar a elevadas velocidades de corte y avances lentos con condiciones estables.
TB310	K01 - K10	■				×	■	CBN	--	La calidad CBN es adecuada para el mecanizado de materiales endurecidos. Adecuada para el mecanizado a elevadas velocidades de corte y avances lentos con condiciones estables.
	S05 - S10	■								
	H01 - H10	■								

Sustrato

H	Sustrato de base WC-Co
submicron H	Sustrato de base WC-Co de grano fino (< 1 µm)
ultra submicron H	Sustrato de base WC-Co de grano muy fino (< 0,5 µm)
FGM	Sustrato de grado funcional
Cermet	Carburo sin WC
PCD	Diamante policristalino
CBN	Nitruro de Boro Cúbico

Recubrimiento

MT-CVD	Método de recubrimiento químico a media temperatura
PVD	Método de recubrimiento físico a baja temperatura
×	Sin recubrimiento

Hűtés előnyei

+++	Hűtés alkalmazása elengedhetetlen
++	Erősen javasolt
+/-	Opcionális
--	Ne alkalmazzon hűtést



TABLA DE CONDICIONES DE CORTE PARA MANDRINADO

Las plaquitas de torneado estándar se utilizan en las herramientas de mandrinar, pero aquí no se aplican las condiciones recomendadas para el torneado (datos indicados en los recuadros), por lo que se deben seleccionar las condiciones de corte según la siguiente tabla.

Material	Mandrinado en acabado (con plaquita única)				Mandrinado en desbaste (con plaquita doble)			
	Diámetro	Velocidad de corte v_c	Avance f_z	Profundidad de corte a_p	Diámetro	Velocidad de corte v_c	Avance f_z	Profundidad de corte a_p
P	24 – 30	110 – 140	0.05 – 0.15	0.05 – 0.30	24 – 30	110 – 140	0.15 – 0.25	4.2
	29 – 40				105 – 140	0.15 – 0.30	5.7	
	39 – 50					0.20 – 0.30	6.3	
	49 – 102	115 – 150	0.10 – 0.20	0.25 – 0.35				
	100 – 220		0.07 – 0.50	0.30 – 0.40				
	220 – 500							
M	24 – 30	70 – 110	0.07 – 0.15	0.12 – 0.35	24 – 30	69 – 90	0.12 – 0.20	4.2
	29 – 40				80 – 110	0.15 – 0.25	5.7	
	39 – 50					0.20 – 0.50	6.3	
	49 – 102	80 – 110	0.10 – 0.20	0.20 – 0.30				
	100 – 220		0.12 – 0.20	0.25 – 0.35				
	220 – 500							
K	24 – 30	70 – 110	0.07 – 0.15	0.12 – 0.35	24 – 30	60 – 110	0.20 – 0.30	4.2
	29 – 40				0.25 – 0.35		5.7	
	39 – 50				0.20 – 0.50		6.3	
	49 – 102	80 – 115	0.30 – 0.40					
	100 – 220		0.12 – 0.20	0.30 – 0.45				
	220 – 500		0.25 – 0.75					
N	24 – 30	150 – 300	0.05 – 0.15	0.12 – 0.35	24 – 30	120 – 300	0.20 – 0.30	4.2
	29 – 40				150 – 360	0.25 – 0.35	5.7	
	39 – 50					0.10 – 0.20	0.30 – 0.40	6.3
	49 – 102	150 – 360	0.10 – 0.25	0.30 – 0.45				
	100 – 220		0.25 – 0.75	0.30 – 0.40				
	220 – 500							
S	24 – 30	30 – 40	0.07 – 0.15	0.12 – 0.35	24 – 30	25 – 35	0.12 – 0.20	4.2
	29 – 40				30 – 45	0.15 – 0.25	5.7	
	39 – 50					0.20 – 0.50	6.3	
	49 – 102	30 – 45	0.10 – 0.20	0.20 – 0.30				
	100 – 220		0.25 – 0.75	0.20 – 0.35				
	220 – 500							
H	24 – 30	30 – 40	0.07 – 0.15	0.12 – 0.35	24 – 30	25 – 35	0.12 – 0.20	4.2
	29 – 40				30 – 45	0.15 – 0.25	5.7	
	39 – 50					0.20 – 0.50	6.3	
	49 – 102	30 – 45	30 – 45	0.20 – 0.30				
	100 – 220		0.25 – 0.75	0.20 – 0.35				
	220 – 500							

Instrucciones de ajuste – cabezas de desbaste

- Montar plaquitas nuevas en los asientos.
- Aflojar el tornillo(s) de bloqueo de la corredera y apretar (tensar) muy suave.
- Girar el tornillo de ajuste para mover la(s) corredera(s) a un diámetro menor que el requerido.
- Girar en sentido contrario el tornillo de ajuste y colocar la(s) corredera(s) al diámetro requerido.
- El reglaje se puede hacer con la herramienta montada en la máquina, fuera de la máquina o en un banco de pre-reglaje.
- Apretar el tornillo(s) de bloqueo en un útil de pre-reglaje.



Para cabezas de 68 y superiores (tipo cartucho)

- Los cartuchos tienen un tornillo individual para su ajuste radial.
- Soltar el tornillo de bloqueo de uno de los dos cartuchos.
- Girando el tornillo de ajuste (cabezas), mover el cartucho hasta que ambas plaquitas esten centradas. (R1 = R2)

Instrucciones de ajuste – cabezas de acabado

- Todas las cabezas de acabado y micro cabezas tienen un ajuste micrométrico con una graduación de 0,002 mm.
- Montar plaquitas nuevas en los asientos.
- El reglaje debería ser realizado preferiblemente en un comparador o en un útil de pre-reglaje.
- Montar plaquitas nuevas en los asientos.
- Aflojar el tornillo(s) de bloqueo de la corredera y apretar (tensar) muy suave.
- Girar el tornillo de ajuste para mover la(s) corredera(s) a un diámetro menor que el requerido.
- Girar en sentido contrario el tornillo de ajuste y colocar la(s) corredera(s) al diámetro requerido.
- Apretar tornillo(s) de bloqueo.
- En aplicaciones en las que sea difícil mantener una tolerancia especificada, recomendamos ajustar la cabeza inicialmente a un diámetro menor, mandrinar un agujero y medir. Después ajustar al diámetro apropiado utilizando el micrómetro de la cabeza y hacer otra pasada.



Elección del ángulo de posición

75°



90°



- Agujeros pasantes
- Desbaste pesado a avances elevados
- Tendencia a „seguir“ el agujero existente (descentramiento, etc)
- Agujeros profundos - herramientas de mandrinado largas (el efecto auto-centrante ayuda a la entrada)

- Agujeros ciegos
- Mandrinados escalonados con escuadra a 90°
- Agujeros cortos - herramientas de mandrinado cortas (recolocado y corrección de agujeros desplazados)
- Mandrinado con cartuchos escalonados (cartuchos 68 y superiores)

Este tipo de cabezas de mandrinado pueden ir equipadas con un cartucho simétrico y un cartucho escalonado. Es necesario tener en cuenta que los cartuchos escalonados tienen la letra „S“ al final de la descripción.

Ejemplos: 2CT 90 402 N S; 2CT 90 300 S; 2CT 90 402 S.

Mandrinado simétrico

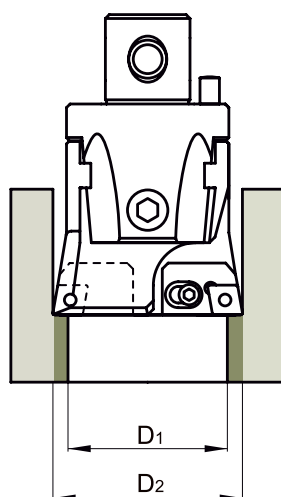

2CT □□ □□□ + 2CT □□ □□□
3CT □□ □□□ + 3CT □□ □□□

Mandrinado escalonado

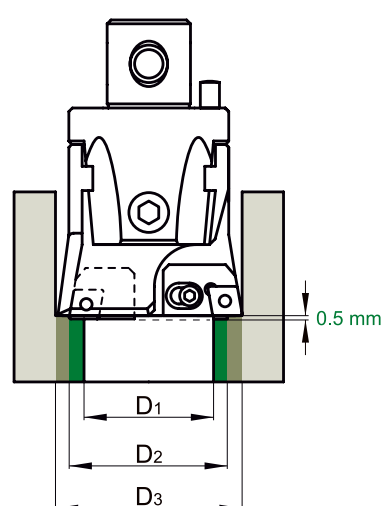

2CT □□ □□□ S + 2CT □□ □□□
3CT □□ □□□ S + 3CT □□ □□□

El mandrinado escalonado permite un incremento en el volumen de arranque de viruta entre D1 y D3 durante una pasada, aproximadamente de 4 a 6 mm en comparación con el mandrinado simétrico.

Es necesario tener en cuenta que para mandrinado escalonado, el avance por minuto debe ser calculado como para una herramienta de un sólo diente.



SISTEMA DE MONTAJE DE CABEZALES DE MANDRINAR DE GRAN DIÁMETRO

Atención: durante todo el proceso de montaje, el tornillo de bloqueo (pos. 2) debe estar aflojado.

Cómo acoplar un cabezal de mandrinar de gran diámetro en el cono
Extraiga los tornillos de posición (pos. 1) y empuje las correderas hasta que visualice los cuatro orificios donde insertar los tornillos de acoplamiento. Junte la cara plana del cono con los cuatro orificios roscados por el extremo posterior del cabezal y, a continuación, coloque y apriete los 4 tornillos de acoplamiento.

Montaje de las correderas en el cabezal

Coloque ambas correderas en las guías en forma de V y deslícelas hasta que coincidan con los orificios roscados. Coloque los tornillos (pos.1) y apriételes ligeramente. Estos tornillos tienen una función doble: fijar la corredera dentro de las guías V y unir ambas correderas con la tuerca de avance de bronce. Por último, compruebe que la corredera (o correderas para el desbaste) se desliza suavemente.

ACABADO

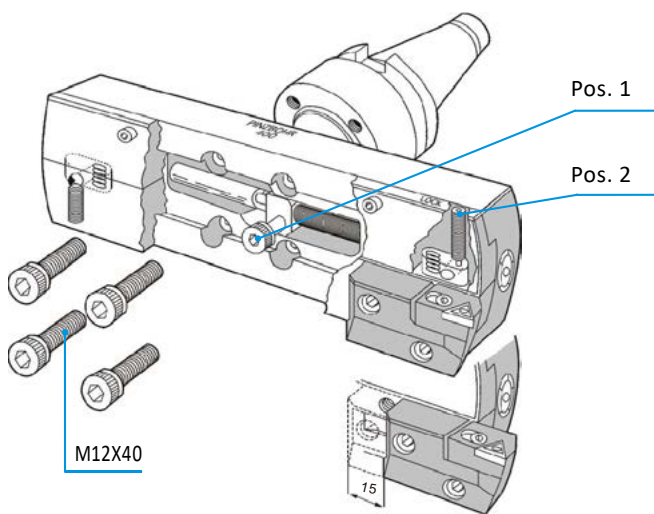

DESBASTE

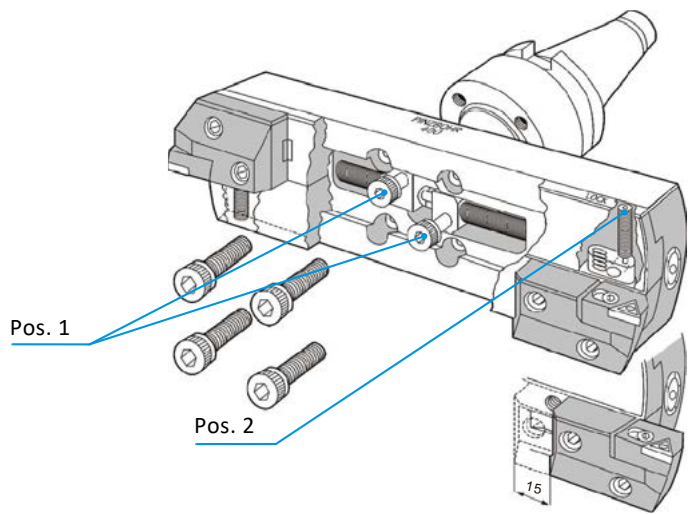

Velocidades y avances

Las velocidades óptimas o máximas y los avances dependerán del material, la máquina, el montaje y el voladizo de la herramienta.

Profundidad de mandrinado - voladizo para desbaste y acabado

En condiciones adecuadas se pueden alcanzar profundidades de 5xD para desbaste y 3xD para acabado. Al aumentar el voladizo, la estabilidad mecánica del cuerpo de la herramienta disminuye. Las herramientas demasiado largas tienen tendencia a flexiones, así como vibraciones armónicas (alta frecuencia). Esta vibración puede causar el movimiento de los componentes internos de ajuste de la cabeza, produciéndose agujeros cónicos fuera de medida.

En muchos casos las vibraciones armónicas de alta frecuencia se pueden amortiguar incrementando el avance y/o reduciendo la velocidad de corte.

Conviene tener en cuenta que el comportamiento del corte cambiará con el número extensiones de correderas (porta plaquitas) desde la cabeza, siendo necesario realizar ajustes en función de velocidades y avances.

Profundidad de mandrinado - voladizo para micro cabezas de mandrinado

La máxima profundidad de mandrinado con barras de mandrinar de acero no deberían exceder de 5 veces el diámetro de la barra y 7 veces el diámetro de la barra con barras de metal duro. Recomendamos acortar el voladizo de la barra al mínimo imprescindible para la profundidad del agujero.

Para aplicaciones de desbaste pesado se debe seleccionar el mayor radio de punta disponible, a menos que exista otra especificación. Para mandrinado en acabado con muy pocas creces, es mucho más ventajoso seleccionar el menor radio de punta disponible para mini-

mizar la flexión lateral. Esto puede ser especialmente importante en aplicaciones con largos voladizos.

Cabezas de desbaste de 75° contra 90°

Las cabezas de desbaste de 75° se deben utilizar cuando hay que quitar mucho material y no hay que escuadrar al fondo de un agujero ciego o en agujeros con varios diámetros. El ángulo de posición de 75° tiene tendencia a auto centrarse con el agujero existente y por tanto corta de forma muy estable. Si el agujero previo está descentrado, movido o no está recto entonces la recomendación es utilizar un ángulo de posición de 90° ya que éste tiene menos tendencia a „seguir“ el agujero existente.

Creces del material

Las creces máximas para mandrinado en desbaste se deben disminuir cuando se mecanizan materiales difíciles, con voladizos largos o con extensiones de correderas.

Radio de plaquita

Para aplicaciones de desbaste pesado se debe seleccionar el mayor radio de punta disponible, a menos que exista otra especificación. Para mandrinado en acabado con muy pocas creces, es mucho más ventajoso seleccionar el menor radio de punta disponible para minimizar la flexión lateral. Esto puede ser especialmente importante en aplicaciones con largos voladizos.

4 Filos de corte por plaquita

Las plaquitas rómbicas de 80° ofrecen normalmente dos filos de corte. Sin embargo, se pueden utilizar los cuatro filos si se usan cabezas de desbaste de 75° y 90° del mismo tamaño. Lo mismo es posible entre una cabeza de desbaste de 75° y una cabeza de acabado de 90°.





SIMPLY RELIABLE

Como profesional se puede juzgar la calidad del trabajo sólo mirando la viruta. Nuestra viruta es una forma limpia y sin complicaciones que en sí misma cuenta una historia. Es una señal clara y consistente y es por eso que la usamos como un símbolo por ser **Simplemente Fiables**.

DORMER PRAMET

Austria

T: +31 10 2080 240
info.at@dormerpramet.com

Belgium & Luxembourg

T: +32 3 440 59 01
info.be@dormerpramet.com

Brazil

T: +55 11 5660 3000
info.br@dormerpramet.com

Canada

T: (888) 336 7637
En Français: (888) 368 8457
cs.canada@dormerpramet.com

China

T: +86 21 2416 0508
info.cn@dormerpramet.com

Croatia

T: +385 98 407 489
info.hr@dormerpramet.com

Czech Republic

T: +420 583 381 111
info.cz@dormerpramet.com

Denmark

T: 808 82106
info.se@dormerpramet.com

Finland

T: 0205 44 7003
info.fi@dormerpramet.com

France

T: +33 (0)2 47 62 57 01
info.fr@dormerpramet.com

Germany

T: +49 9131 933 08 70
info.de@dormerpramet.com

Hungary

T: +36-96 / 522-846
info.hu@dormerpramet.com

India

T: +91 11 4601 5686
info.in@dormerpramet.com

Italy

T: +39 02 30 70 54 44
info.it@dormerpramet.com

Kazakhstan

T: +7 771 305 11 45
info.kz@dormerpramet.com

Mexico

T: +52 (555) 7293981
cs.mexico@dormerpramet.com

Netherlands

T: +31 10 2080 240
info.nl@dormerpramet.com

Norway

T: 800 10 113
info.se@dormerpramet.com

Poland

T: +48 32 78-15-890
info.pl@dormerpramet.com

Portugal

T: +351 21 424 54 21
info.pt@dormerpramet.com

Romania

T: +4(0)730 015 885
info.ro@dormerpramet.com

Russia

T: +7 (495) 775 10 28
info.ru@dormerpramet.com

Slovakia

T: +421 (41) 764 54 60
info.sk@dormerpramet.com

Slovenia

T: +385 98 407 489
info.si@dormerpramet.com

Spain

T: +34 935717722
info.es@dormerpramet.com

Sweden

responsible for Iceland
T: +46 35 16 52 96
info.se@dormerpramet.com

Switzerland

T: +31 10 2080 240
info.ch@dormerpramet.com

Turkey

T: +90 533 212 45 47
info.tr@dormerpramet.com

Ukraine

T: +38 067 566 38 80
T: +38 067 566 81 51
info.ua@dormerpramet.com

United Kingdom

responsible for Ireland
T: 0870 850 4466
info.uk@dormerpramet.com

United States of America

T: (800) 877-3745
cs@dormerpramet.com

Other countries

South America

T: +55 11 5660 3000
info.br@dormerpramet.com

Adria

T: +420 583 381 527
info.rcee@dormerpramet.com

Rest of the World

Dormer Pramet International UK
T: +44 1246 571338
info.int@dormerpramet.com

Dormer Pramet International CZ
T: +420 583 381 520
info.int.cz@dormerpramet.com

DP-CAT-HOLEMAKING-2021-ES

FOLLOW US...



www.dormerpramet.com



youtube.com/dormerpramet



facebook.com/dormerprametsocial



linkedin.com/company/dormerpramet



instagram.com/dormerprametsocial



twitter.com/dormerpramet